



## Zebrafish Animal Model for Biomedical Research – A Review

Senthil Kumar B<sup>1\*</sup> and Vishal T<sup>2</sup>

<sup>1</sup>Head, Central Research Laboratory for Biomedical Research, Vinayaka Mission's Kirupananda Variyar Medical College & Hospitals, Vinayaka Missions Research Foundation (Deemed to be University), Salem 636308, Tamil Nadu, India.

<sup>2</sup>Research Assistant, Central Research Laboratory for Biomedical Research, Vinayaka Mission's Kirupananda Variyar Medical College & Hospitals, Vinayaka Missions Research Foundation (Deemed to be University), Salem – 636308, Tamil Nadu, India.

Received: 09 Nov 2021

Revised: 18 Dec 2021

Accepted: 11 Jan 2022

### \*Address for Correspondence

#### Senthil Kumar B

Head, Central Research Laboratory for Biomedical Research,  
Vinayaka Mission's Kirupananda Variyar Medical College & Hospitals,  
Vinayaka Missions Research Foundation (Deemed to be University),  
Salem 636308, Tamil Nadu, India.  
Email: skdrchinu88@gmail.com



This is an Open Access Journal / article distributed under the terms of the **Creative Commons Attribution License** (CC BY-NC-ND 3.0) which permits unrestricted use, distribution, and reproduction in any medium, provided the original work is properly cited. All rights reserved.

### ABSTRACT

Zebrafish is a tropical fresh water fish native of southeast Asia and it measures about 2.5 cm to 4 cm in length. Zebrafish has similar genetic makeup as that of humans. They share 70% of genes with humans. 84% of genes are known to be associated with human disease have a zebrafish counterpart. As a vertebrate, the zebrafish has the same major organs as humans like blood, muscles, kidneys and eyes. The zebrafish genome has been sequenced which enabled researchers to create mutations in more than 14,000 genes to study their functions. Zebrafish has an unique ability to repair their heart muscle researchers working out to find out the specific factors involved in this process so that it can help humans with heart failures. The review throws light on the use of Zebrafish for various biomedical researches.

**Key words:** Zebrafish, Biomedical research, Mutation, Genome, Animal model.

### INTRODUCTION

The zebrafish (Zoological name - *Danio rerio*) is a tropical freshwater fish found mostly in southeast Asia. The species commonly found in slowly moving water or stagnant water [1]. The species has large fecundity and fertility rates it has been used widely as an animal model for various research studies. Zebrafish has been used as an animal model for research in vertebrate embryonic development, adult stem cell and regenerative medicine [2]. Zebrafish embryos, larvae and the adults are now commonly used as an animal model to check out the gene function in several human



**Senthil Kumar B and Vishal T**

diseases [3]. The Zebrafish is also a potential model for diseases and drug screening [4]. Zebrafish is an useful animal model for neurobiology [5], developmental biology, drug research, virology [6], microbiology [7] and genetics [8]. Zebrafish, have a well-developed immune system, both innate and adaptive, which is similar to the mammalian immune system [9]. It helps to develop and design various genetic tools for experimental investigations [10].

**Taxonomy of Zebrafish [11]:**

- **Species:** *D. rerio*
- **Class:** Actinopterygii
- **Order:** Cypriniformes
- **Family:** Cyprinidae
- **Phylum:** Chordata
- **Genus:** Danio
- **Kingdom:** Animalia

**Habitat:**

Zebrafish lives in slow moving or stagnant bodies of water. They are fresh water habitats and do not live in salt or brackish water. They also live in ponds, streams, rivers and even rice paddies. They are adaptable to all manmade or altered habitats.

**Reproduction**

The approximate sexual maturity time for them is three months. A male must be present to induce female ovulation and egg fecundation. Females lay more than 200 eggs in each mating. This vast progeny is another advantage of using this particular family of fishes. Upon eggs release, embryonic development begins. The zebrafish embryo has the capacity of developing faster, with all significant organs appearing within a duration of 36 hours post-fertilization. The embryo starts as a yolk with a single enormous cell on top, that divides into two and continues to divide into thousands of cells, these cells then slowly migrate down to the the sides of the yolk and starts with morphogenesis forming a head and tail, which later grows and finally gets separated from the body. From 4 dpf, heart physiology is stable; from 5 dpf they respond to optical, touch and acoustic stimuli and display free swimming, which suggests a sophisticated nervous system; also from 5 days, the digestive/excretory system is fully functional. Interestingly, zebrafish embryonic and Larval tissues are optically transparent, which allows visualizing morphogenetic movements and organs in vivo (i.e., Heart beating). Thus, the fast life cycle and transparency are additional features making this species a robust animal model for biomedicine [12].

Zebrafish has more advantages over rodent models in the study of vertebrate diseases and development. The optical clarity of the developing embryo, helps for live imaging at the organism level [13,14]. Tissue specific transgenic animal models can be easily generated using various selected gene promoters. Tol2-based transgenic system in zebrafish [15] allows the control of gene expression by coupling with various regulatory elements like GAL4/UAS or Cre/LoxP [16,17]. The live imaging of Zebrafish cells along with its cellular dynamics in vivo helps to study all the underlying molecular mechanisms of organogenesis. Zebrafish has become a convenient animal model for biomedical research. Zebrafish has become an important biomedical model due to its transparent embryos which develop outside the uterus. The unique developmental process allows researcher to study the process of embryogenesis. Innovation and development of molecular techniques has allowed Zebrafish to be used as an animal vertebrate model in various aspects of research. This present review mainly focuses on the use of Zebrafish as a biomedical model in research related to cancer, tumorigenesis, diabetes, CVD, Metabolic diseases & disorders [18].

**Research on Cancer**

Zebrafish was first used in cancer research during the 1960s as an animal model to test the effects of carcinogens [19]. When exposed to various carcinogenic agents such as MNNG (N-methyl-N-nitro-N-nitrosoguanidine), DENA (diethylnitrosamine), and DMBA (7.12 - dimethylbenz(a)anthracene), the fish will developed cancer [20]. Zebrafish has proven to be an ideal model to study the malignancy of several tumors by application of tumor transplantation



**Senthil Kumar B and Vishal T**

assays [21]. Several types of cancer has been studied with zebrafish model, such as leukemia [22], endocrine melanoma, and liver cancer [21] research involves xenotransplantation of human tumor cells into zebrafish embryos (xenografts) to check out the tumor cell migration, metastasis and angiogenesis [23] and it also helps to trace out the effects of potential therapeutic targets [21]. The advanced technology of forward and reverse genetic tools, along with non-invasive *in vivo* imaging technology, zebrafish serve as an ideal vertebrate model to study the cancer [24]. Zebrafish was used to study the melanoma progression. The *BRAF* mutant fish developed large group of proliferating melanocytes, the *NRAS* mutant fish showed severe defects in pigment pattern but they do not develop melanoma. When both of these transgenic fish lines were crossed with p53 mutant lines, the melanoma phenotype progressed significantly proving the importance of p53 function in melanoma tumor suppression [25,26]. Transgenic fish lines are developed, expressing the oncogenic human *HRAS* gene in the melanocytic cell line that was used for epigenetic regulation in all the melanoma model [27]. Tavares et al., 2013 had compiled findings of various melanoma research and concluded that zebrafish melanomas resemble human melanomas morphologically, genetically and epigenetically thus zebrafish is found to be more suitable for melanoma model [24,28].

Zebrafish helps to study pathogenesis and treatment for skin cancer (melanoma and SCC). The Zebrafish can be used as an animal model to study the melanoma development, its progression, drug screening, and its treatment. The zebrafish models has been used to identify the key molecules responsible for the development of various head and neck squamous cell carcinoma (HNSCC) and cutaneous squamous cell carcinoma (cSCC) and for SCC target therapies [29].

**Tumorigenesis**

A variety of fishes have been used as a vertebrate model to study the tumors induced by environmental carcinogens. Among all those varieties Zebrafish was found to be more suitable for investigating the process of embryogenesis, organogenesis, and tumorigenesis.<sup>30</sup> The chemically induced tumors in zebrafish and humans are found to be more similar histopathologically<sup>31</sup> and tumor suppressor genes (TSGs) and orthologous oncogenes have been identified to be similar in Zebrafish and humans.<sup>31</sup> Hepatic gene expression of Zebrafish and humans had shown the conservation of various gene expression profiles in various stages of tumor aggressiveness between these two phylogenetically distinct species [32,33].

**Research on Diabetes mellitus**

Zebrafish were used for various developmental studies/ organogenesis, that includes pancreas development and its morphogenesis. Studies performed in zebrafish helps to understand extrinsic signaling molecules such as *FGF*, *retinoic acid* and *Shh* in influencing intrinsic transcriptional programs [34]. All these research have made zebrafish as an effective alternative model to study the onset of diabetes mellitus and its treatment modalities. Zebrafish turns to be hyperglycemic when exposed to high glucose and they develop retinopathies with prolonged high blood sugar levels [35].

Zebrafish when exposed to high caloric and high-fat diets, obesity and obesity related disease were induced and that activates metabolic pathways which is similar to humans. Capiotti et al. (2014) showed that zebrafish immersed in high-glucose solution of 111 mM resulted in an increase of 41% fructosamine levels in the eyes, decreased amounts of mRNA for insulin receptors in muscle [36]. Researchers also developed Zebrafish model of type 2 diabetes mellitus by overfeeding a high-calorie diet [37]. The gene expression profiles of pancreas shows a common pathway for development of type 2 diabetes mellitus which was reported to be similar in zebrafish and humans. The relationship between age and type 2 diabetes mellitus was also studied and results shown that young zebrafish (4 to 11 months old) develops hyperglycemia slower than older zebrafish with increasing concentrations of glucose [38]. Immersion of adult zebrafish in a 1% glucose solution for 24 hr resulted in an increase blood glucose level up to 400 mg/dL [39]. The two transgenic models of insulin resistance includes skeletal muscle insulin resistance produced by transgenic expression of IGF-I receptor in skeletal muscle. In the second model, insulin resistance was attained via liver specific knockdown of the insulin receptor gene using CRISPR/Cas9 [40].



**Senthil Kumar B and Vishal T****Lipid-related Diseases:**

The suitability of the zebrafish to study the lipid-related diseases is due to its similarities with mammals in lipid absorption, processing and metabolism [41]. Zebrafish has been shown to be an excellent atherosclerosis model, which allows for the analysis of lesion development, lipid deposition and various cellular level changes in the vascular wall, and macrophage lipid deposition *in vivo* [42]. Since Zebrafish energy homeostasis resembles to that of mammals, including melanocortin system that responds to leptin,[43] and similar modulation of fat content in mammals it is involved in obesity research [44]. The metabolism of cholesterol in zebrafish has common transcriptional regulators SREBP (sterol-regulatory-element-binding protein) and LXR (liver X receptor) systems which was found to be similar in mammals. The mutant fish genes show similar phenotypes to that of human pathologies [45].

**Cardiovascular Diseases**

The development of cardiovascular system in zebrafish has been studied and characterized, for various research involving angiogenesis and vasculogenesis. The feasibility and suitability of this animal model for cardiovascular studies is due to its optical clarity of external embryological development. The sequential observation of developing heart and its blood vessels without invasive techniques helps in cardiovascular disease research in both wild type and mutant Zebrafish embryos [46,47]. Since zebrafish has the capacity to regenerate hearts, researchers can investigate the various causes of defects in heart shape, size and its function, and also the cellular sources or stem cells involved in the regeneration of cardiac muscles [48]. Several cardiovascular diseases were also studied in zebrafish disease models, like the Holt-Oram syndrome, congenital defects of atrioventricular wall, coarctation of aorta, dilated (DCM) and hypertrophic cardiomyopathy (HCM), long & short QT syndromes and various arrhythmias [49].

**Cardiotoxicity**

Cardiotoxicity is one of the major concerns in drug development. Studies showed that toxic effects of cardiotoxic agents in Zebrafish embryos have similar mechanism to that of humans [50]. Treatment with drugs such as clomipramine and terfenadine caused impaired cardiac functions, hemorrhage, edema, cessation of heartbeat and finally resulted in death of zebrafish [51]. Researchers used transgenic zebrafish model for testing of small molecules that modulate the heart rate [52,33].

**Metabolic diseases**

Zebrafish is also useful in studies of metabolic disorders. Zebrafish has all organs that are required for metabolic controls including hypothalamus, pancreas and insulin-sensitive tissues [53]. It is used as a model for fatty liver disease. The higher rate of nonesterified fatty acid (NEFA) in the organism results in triglycerides accumulation, which leads to lower level of glucose and insulin in the blood which in turn blocks the metabolic pathways of burning fats, that causes fatty liver disease and production of ketones. In the zebrafish, the formation of the liver primordium and the differentiation of hepatocytes and cholangiocytes can be observed after 48 hours post fertilization [54]. Intestinal lipids can also be observed *in vivo* using fluorescently labelled fatty acid analogues [55]. The zebrafish mutant serves as precious animal model to study fatty liver disease and its therapeutic trials [56].

Zebrafish metabolism exhibits unique characteristics similar to that of human metabolism. Zebrafish embryos consume yolk for initial 5 days of development, later they feed for further growth to prevent them from undergoing fasting. The process of feeding to fasting transition at 5 to 6 days post fertilization has been utilized to study the metabolic homeostasis upon energy deprivation [57]. As first adipocyte develops only after of post fertilization, it helps to study adipogenesis and its pathogenesis in metabolic disorders [58,59].





**Senthil Kumar B and Vishal T**

## CONCLUSION

Zebrafish is an excellent animal model to explore biomedical research. The genome sequencing, mutagenesis and carcinogenesis research in Zebrafish can help the mankind in new drug discovery. The Zebrafish is also a potential model for various diseases and drug screening. Zebrafish helps in embryogenesis, organogenesis research. It also helps to develop and design various genetic tools for research [10].

## REFERENCES

1. Spence R, Gerlach G, Lawrence C, Smith C. The behaviour and ecology of the zebrafish, *Danio rerio*. *Biol Rev Philos Soc.*2008;83:13-34.
2. Major RJ, Poss KD. Zebrafish heart regeneration as a model for cardiac tissue repair. *Drug Discov Today Dis Models.*2007;4:219-25.
3. Bárbara Tavares, Susana Santos Lopes. The importance of zebrafish in biomedical research. *Acta Med Port.*2013;26(5):583-592.
4. Panula P, Sallinen V, Sundvik M, Kolehmainen J, Torkko V, Tiittula A, Moshnyakov M, Podlasz P. Modulatory neurotransmitter systems and behavior: towards zebrafish models of neurodegenerative diseases. *Zebrafish.*2006;3:235-247.
5. Haffter P, Odenthal J, Mullins MC, Lin S, Farrell MJ, Vogelsang E, Haas F, Brand M, van Eeden FJ, Furutani-Seiki M, Granato M, Hammerschmidt M, Heisenberg CP, Jiang YJ, Kane DA, Kelsh RN, Hopkins N, Nusselein-Volhard C. Mutations affecting pigmentation and shape of the adult zebrafish. *Dev Genes Evol.*1996;206: 260-276.
6. Ludwig M, Palha N, Torhy C, Briolat V, Colucci-Guyon E, Bremont M, Herbomel P, Boudinot P, Levraud JP. Whole-body analysis of a viral infection: vascular endothelium is a primary target of infectious hematopoietic necrosis virus in zebrafish larvae. *PLoS Pathog.*2011;7: 1-11.
7. Levraud JP, Disson O, Kissa K, Bonne I, Cossart P, Herbomel P, Lecuit M. Real-time observation of *Listeria monocytogenes*-phagocyte interactions in living zebrafish larvae. *Infect Immun.*2009;77:3651-3660.
8. Petrie-Hanson L, Hohn C, Hanson L. Characterization of *rag1* mutant zebrafish leukocytes. *BMC Immunol.*2009;10:8-10.
9. Zarkadis IK, Mastellos D, Lambris JD. Phylogenetic aspects of the complement system. *Dev Comp Immunol.*2001;25:745-762.
10. Wienholds E, Schulte-Merker S, Walderich B, Plasterk RH. Target-selected inactivation of the zebrafish *rag1* gene. *Science.*2002;297:99-102.
11. <https://www.microscopemaster.com/zebrafish.html>.
12. Zebrafish General Information, <https://www.zclinics.com/what-about-zebrafish/#>
13. Shin, J. T. & Fishman, M. C. From Zebrafish to human: modular medical models. *Annu Rev. Genomics Hum. Genet.*2002;3:311–340.
14. Lieschke, G. J. & Currie, P. D. Animal models of human disease: zebrafish swim into view. *Nat. Rev. Genet.* 8, 353–367.
15. Kwan, K. M. et al. The Tol2kit: a multisite gateway-based construction kit for Tol2 transposon transgenesis constructs. *Dev. Dyn.*2007;236:3088–3099.
16. Halpern, ME, et al. Gal4/UAS transgenic tools and their application to zebrafish. *Zebrafish.*2008;5:97–110.
17. Langenau, D. M. et al. Cre/lox-regulated transgenic zebrafish model with conditional myc-induced T cell acute lymphoblastic leukemia. *Proc. Natl Acad. Sci.*2005;102:6068–6073.
18. Tsegay Teame, Zhen Zhang, Chao Ran, et al. The use of zebrafish (*Danio rerio*) as biomedical models. *Animal Frontiers.*2019;9(3):68-77.
19. Stanton MF. Diethylnitrosamine-induced hepatic degeneration and neoplasia in the aquarium fish, *brachydanio rerio*. *J Natl Cancer Inst.*1965;34:117–30.



**Senthil Kumar B and Vishal T**

20. Bourque C, Houvras Y. Hooked on zebrafish: insights into development and cancer of endocrine tissues. *Endocr Relat Cancer*.2011;18:R149–64.
21. Taylor AM, Zon LI. Zebrafish tumor assays: the state of transplantation. *Zebrafish*. 2009;6:339–46.
22. Jing L, Zon LI. Zebrafish as a model for normal and malignant hemato-poiesis. *Dis Model Mech*.2011;4:433–8.
23. Tobia C, De Sena G, Presta M. Zebrafish embryo, a tool to study tumor angiogenesis. *Int J Dev Biol*.2011;55:505–9.
24. Liu S, Leach SD. Zebrafish models for cancer. *Annu Rev Pathol*.2011;6:71–93.
25. Patton EE, Widlund HR, Kutok JL, Kopani KR, Amatruda JF, Murphey RD, et al. BRAF mutations are sufficient to promote nevi formation and cooperate with p53 in the genesis of melanoma. *Curr Biol*.2005;15:249–54.
26. Dovey M, White RM, Zon LI. Oncogenic NRAS cooperates with p53 loss to generate melanoma in zebrafish. *Zebrafish*.2009;6:397–404.
27. Anelli V, Santoriello C, Distel M, Köster RW, Ciccarelli FD, Mione M. Global repression of cancer gene expression in a zebrafish model of melanoma is linked to epigenetic regulation. *Zebrafish*.2009;6:417–24.
28. Tavares B, et al. The importance of zebrafish in biomedical research. *Acta Med Port*. 2013;26(5):583-592.
29. Jung DW, Kim J, Che ZM, Oh ES, Kim G, Eom SH, et al. A triazine compound S06 inhibits proinvasive crosstalk between carcinoma cells and stromal fibroblasts via binding to heat shock protein 90. *Chemistry & Biology*.2011;18:1581-1590.
30. Bailey GS, Williams DE, Hendricks JD. Fish models for environmental carcinogenesis: The rainbow trout. *Environmental Health Perspectives*.1996;104(1):5-21.
31. Berghmans S, Jette C, Langenau D, Hsu K, Stewart R, Look T, et al. Making waves in cancer research: New models in the zebrafish. *BioTechniques*.2005;39:227-237.
32. Larn S, Wu Y, Vega VB, Miller LD, Spitsbergen J, Tong Y, et al. Conservation of gene expression signature between zebrafish and human liver tumors and tumor progression. *Nature Biotechnology*.2006;24(1):73-75.
33. Farmanur Rahman Khan and Saleh S ulaiman Alhewairini. Zebrafish ( Danio rerio) as a Model Organism. *Current Trends in Cancer Management*.01-16.
34. Kinkel MD, Prince VE. On the diabetic menu: zebrafish as a model for pancreas development and function. *BioEssays*.2009;31:139–52.
35. Gleeson M, Connaughton V, Arneson LS. Induction of hyperglycaemia in zebrafish (Danio rerio) leads to morphological changes in the retina. *Acta Diabetol*.2007;44:157–63.
36. Capiotti KM, Antonioli R, Kist LW, Bogo MR, Bonan CD, and Da Silva RS. Persistent impaired glucose metabolism in a Zebrafish hyperglycemia model. *Comp. Biochem. Physiol. B. Biochem. Mol. Biol*.2014;171:58–65.
37. Zang L, Shimada, and N. Nishimura. Development of a novel zebrafish model for type 2 diabetes mellitus. *Sci. Rep*. 7:1461.
38. Connaughton, V.P., C. Baker, L. Fonde, E. Gerardi, and C. Slack. 2016. Alternate immersion in an external glucose solution differentially affects blood sugar values in older versus younger zebrafish adults. *Zebrafish* 13:87–94.
39. Gleeson M, Connaughton 2007, and L.S. Arneson. 2007. Induction of hyper-glycaemia in zebrafish ( Danio rerio) leads to morphological changes in the retina. *Acta Diabetol*. 44:157–163.
40. Tsegay Teame, Zhen Zhang, Chao Ran, et al. The use of zebrafish ( Danio rerio) as biomedical models. *Animal Frontiers*.2019;9(3):68-77.
41. Hölttä-Vuori M, Salo VT V, Nyberg L, Brackmann C, Enejder A, Pan-ula P, et al. Zebrafish: gaining popularity in lipid research. *Biochem J*.2010;429:235–42.
42. Stoletov K, Fang L, Choi S-H, Hartvigsen K, Hansen LF, Hall C, et al. Vascular lipid accumulation, lipoprotein oxidation, and macrophage lipid uptake in hypercholesterolemic zebrafish. *Circ Res*.2009;104:952–60.
43. Song Y, Cone RD. Creation of a genetic model of obesity in a teleost. *FASEB J*.2007;21:2042–9.
44. Jones KS, Alimov AP, Rilo HL, Jandacek RJ, Woollett LA, Penberthy WT. A high throughput live transparent animal bioassay to identify non-toxic small molecules or genes that regulate vertebrate fat metabolism for obesity drug development. *Nutr Metab*.2008;5:23.



**Senthil Kumar B and Vishal T**

45. Archer A, Lauter G, Hauptmann G, Mode A, Gustafsson J-A. Transcriptional activity and developmental expression of liver X receptor (lxr) in zebrafish. *Dev Dyn.* 2008;237:1090–8.
46. Holden BJ, Bratt DG, Chico TJ. Molecular control of vascular development in the zebrafish. *Birth Defects Res C Embryo Today.*2011;93:134-40.
47. Sabeh MK, Kekhia H, Macrae CA. Optical mapping in the developing zebrafish heart. *Pediatric Cardiol.*2012;33:916–22.
48. Kikuchi K, Poss KD. Cardiac regenerative capacity and mechanisms. *Annu Rev Cell Dev Biol.* 2012;28:719–41.
49. Dahme T, Katus HA, Rottbauer W. Fishing for the genetic basis of cardiovascular disease. *Dis Model Mech.*2009;2:18–22.
50. Langheinrich U, Vacun G, Wagner T. Zebrafish embryos express an orthologue of HERG and are sensitive toward a range of QT-prolonging drugs inducing severe arrhythmia. *Toxicology and Applied Pharmacology.*2003;193:370-382.
51. Lawson ND, Weinstein BM. In vivo imaging of embryonic vascular development using transgenic zebrafish. *Developmental Biology.*2002;24(8):307-318.
52. Burns CG, Milan DJ, Grande EJ, Rottbauer W, MacRae CA, Fishman MC. High-throughput assay for small molecules that modulate zebrafish embryonic heart rate. *Nature Chemical Biology.*2005;1:263-264.
53. Seth A, Stemple DL, Barroso I. The emerging use of zebrafish to model metabolic disease. *Dis Model Mech.*2013;6:1080-1088.
54. Chu J, Sadler KC. New school in liver development: lessons from zebrafish. *Hepatology.* 2009;50:1656-1663.
55. Farber SA, Pack M, Ho SY, Johnson ID, Wagner DS, Dosch R, Mullins MC, Hendrickson HS, Hendrickson EK, Halpern ME. Genetic analysis of digestive physiology using fluorescent phospholipid reporters. *Science.*2001;292:1385-1388.
56. Nowik N, P. Podlasz1, A. Jakimiuk, et al. Zebrafish: an animal model for research in veterinary medicine. *Polish Journal of Veterinary Sciences.*2015;18(3):663–674.
57. Minchin, J. E. N. & Rawls, J. F. A classification system for zebrafish adipose tissues. *Dis. Model Mech.*2017;10:797–809.
58. Flynn, E. J. 3rd, Trent, C. M. & Rawls, J. F. Ontogeny and nutritional control of adipogenesis in zebrafish (*Danio rerio*). *J. Lipid Res.*2009;50:1641–1652.
59. Choi, et al. Zebrafish as an animal model for biomedical research. *Experimental & Molecular Medicine.*2021;53:310–317.





## Pitahaya a New Superfood: Cultivation Methods and Medicinal Properties of the Fruit

Domenico Prisa\*

CREA Research Centre for Vegetable and Ornamental Crops, Council for Agricultural Research and Economics, Piacenza, Italy

Received: 19 Nov 2021

Revised: 22 Dec 2021

Accepted: 12 Jan 2022

### \*Address for Correspondence

#### Domenico Prisa

CREA Research Centre for Vegetable and Ornamental Crops,  
Council for Agricultural Research and Economics,  
Piacenza, Italy

Email: domenico.prisa@crea.gov.it



This is an Open Access Journal / article distributed under the terms of the **Creative Commons Attribution License** (CC BY-NC-ND 3.0) which permits unrestricted use, distribution, and reproduction in any medium, provided the original work is properly cited. All rights reserved.

### ABSTRACT

A pitaya or pitahaya is the fruit of several different cactus species indigenous to the Americas. Pitaya usually refers to fruit of the genus *Stenocereus*, while Pitahaya or dragon fruit refers to fruit of the genus *Selenicereus* (formerly *Hylocereus*), both in the family Cactaceae. Dragon fruit is cultivated in Mexico, Southeast Asia, India, the United States, the Caribbean, Australia, Mesoamerica and throughout tropical and subtropical world regions. These fruits are commonly known in English as "dragon fruit," a name used since about 1963, apparently derived from the leather-like skin and prominent scaly spikes on the outside of the fruit. The results of various researches show that dragon fruit has preventive activity for several diseases that affect humans, such as cancer, digestive problems, diabetes. Further studies however on dragon fruit are needed to confirm and expand the knowledge about the medicinal qualities of the plant and fruit for the prevention and alternative treatment of various diseases.

**Keywords:** Pitahaya; Cactus plants; Medicinal extracts; *Hylocereus*; Anti-cancer fruits

## INTRODUCTION

*Hylocereus undatus* Britt, also known as Pitahaya fruit, Jade dragon fruit, red dragon fruit and dragon pearl fruit, belongs to the genus *Trigonocarpus* in the Cactaceae. It is a type of cactaceous plant with ornamental flowers and edible fruits. Native to Costa Rica, Cuba, Mexico and other tropical areas of Central America, also present in China and Taiwan. Pitahaya is a species of perennial climbing succulent. The rootstock is dark green, very sturdy and triangular in shape. It has a wavy edge and clings to other plants. The flower is white and the huge ovary is lower, which has the name of "king flower". The fruit is similar to an olive, the outer surface has the fleshy scale that curls outward, and the flesh is covered with small black seeds. The texture is mild and the flavor is fragrant. The stem of







### Domenico Prisa

the pitahaya is rich in plant polysaccharides and accounts for about 7% of the dried product [1]. The cultivation of pitahaya is pretty recent, the qualities of the fruit are known since no more than 50 years. For a long time its cultivation, thanks to the remarkable qualities of rusticity demonstrated by the plant, has been limited to ornamental purposes only. Although it is native to the desert areas of Central America (Mexico, Costa Rica) it has easily adapted to humid tropical areas as well (Colombia, Panama, Uruguay and Brazil). This adaptability may mean that pitahaya has remarkable and interesting characteristics of acclimatization which suggest a much wider range of cultivation than the present one. In Colombia it has found an ideal habitat in an area which is between 800 and 1900 meters above sea level, where average annual temperatures are recorded between 21 and 22°C. Specialized cultivations are in fact found at 50-150 Km from Bogotá together with those of bananas, coffee and citrus fruits [2-3].

#### PITAHAYA BOTANICAL CHARACTERISTICS

Pitahaya, like cactus, has the characteristic metamorphosis of the leaf apparatus: the leaves are transformed into thorns, which is an important defense against the loss of water through stomata. Chlorophyll photosynthesis is done by the stem and by the branches which are fleshy and green because they are provided with chloroplasts. This metamorphosis has occurred through a long, but gradual, evolutionary process caused by the desert environment with very low humidity, in which cacti have survived. Pitahaya is structurally similar to the prickly pear plant; it is formed by spiny triangular section branches, they are similar in function to the prickly pear blades, but they differ morphologically in the shape which appears more elongated. The branches originate from the axillary buds. Their length can reach and exceed one meter, but normally they are 50-70 cm. Some branches emit fleshy filaments, a kind of aerial roots, a couple of millimeters thick and 5 to 10 cm long, which probably perform an anchoring function [4]. The stem has secondary lateral ramifications such as not to allow at first glance a distinction from the main axis. The plant, however, is not in a condition to stand up, so it needs a brace. The main characteristic of pitahaya is the presence on all the length of its branches of particular convex "aureoles" in the shape of C; above the aureoles there are the thorns at whose axils are located the buds which can give origin to branches or flowers and then to fruits. Roots are superficial, however they are able to quickly absorb the rare rain which falls in desert areas typical of the original environment of the plant. Pitahaya can also emit roots at the base of the stem (aerial roots) which have the task of better anchoring the plant to the ground, and on the branches [5-6].

In Colombia it is relatively easy to observe 20 years old pitahaya plants with a root system that covers an area of soil extended from 2 to 3 m, of the same diameter, but not deeper than 12 cm. The flower, hermaphrodite, is tubular shaped. The color of the tepals varies from white to pink; remarkable are its dimensions: about 20 cm wide and long up to 30-40 cm. The flower opens at night, for 1-2 nights, and gives off a scent that attracts numerous insects; during the day, however, it remains closed. Pollination is autogamous, that is it happens through the pollen of the same flower; it is not rare however the crossed pollination by some pollinating insects. From the formation of the floral button to the opening of the flower it takes an average of 60 days. Flowering in Italy, normally takes place in the first ten days of September. The fruit is a berry with epicarp sprinkled with squamiform areas, in relief, provided with thorns, which are necessarily removed at the time of marketing. In the pulp of mucilaginous consistency (the color is white or red according to the species) are contained many seeds, about 200, edible, dark colored [7-8]. From the fertilization to the complete maturation it takes from 4 to 8 months according to the climatic conditions in which the plant grows. In Colombia this period goes from June to October and from August to January, whereas in Italy from September to January. For pitahaya it is important the temperature does not undergo sudden changes during the whole period of the formation of the fruit until its complete ripening. Pitahaya has proven to bear considerable temperature changes even in greenhouses (from -2°C minimum to +15°C maximum in November), but it is necessary to point out that flowering and fruit set require high temperatures and limited changes. The pulp of the fruit contains a substance, captin, which has an invigorating effect on the heart and on blood pressure; in practice it acts as a regulator and, at the same time, as a nervous calming agent. Seeds, instead, contain an oil with laxative and diuretic action with a positive effect on the digestive system [9].



**Domenico Prisa****PITAHAYA SPECIES**

The main species of pitahaya which can be cultivated and consumed are: yellow pitahaya (*Hylocereus triangularis*) and red pitahaya (*Hylocereus ocamponis*). Yellow pitahaya is the most important species from a commercial point of view (the fruit resists to manipulation and transportation). Size of berries is variable: there are some which measure longitudinally 12 cm and transversely 5-8 cm: average values are respectively 10 and 6 cm. Botanical descriptions and cultivation techniques refer exclusively to yellow and red pitahaya [1]. In Colombia, where specialized cultivations are expanding, yellow pitahaya is considered as one of the best fruits being produced in the country. Red pitahaya is a climbing plant, with branches having a triangular section, and produces very sweet fruits (berries). Both the scales of the skin and the pulp are red in color. Unfortunately the fruits are very delicate: they do not lend themselves to transportation and frigoconservation, therefore from a commercial point of view it has inferior prospects compared to the yellow pulp species [10-11-12]. The interest in cultivating pitahaya in Italy was born in the '90s, when some companies which commercialized exotic fruits, started receiving some plateaux of pitahaya from Colombia. The request for the new exotic fruit, having an exquisite taste, was not long in coming, however it was not possible to count on a continuous availability from the exporting country. It was therefore necessary to know more about the plant and to start experimental trials in our country as well [13]. The purpose of this new research was to promote the necessary agronomic and environmental indications which could ensure the adaptation of the new species to our regions. From the experience acquired, it emerged that in the warm areas of Central-Southern Italy it is possible to cultivate pitahaya; obviously it is necessary to deepen the research in order to obtain further data for the evaluation and acclimatization in our country. If we consider that in a cold greenhouse the plant has resisted to -2°C, it is possible to deduce that there are interesting prospects of cultivation in a central-southern area, similar to the one reported for prickly pear [14-15].

**CULTIVATION SOIL AND CLIMATE**

Pitahaya which is a plant native to desert environments, obviously prefers tropical climates. In Colombian environments, where minimum temperatures rarely go down below 18°C and exceed 27°C, pitahaya has found its best habitat. Experiences of cultivation carried out in the same country (Bogotá), where minimum temperatures close to 0°C have been recorded, did not however show serious damages to the plants, if anything a decrease in plant production was noticed. First of all, in spite of the minimum temperature values, it is not possible to establish with accuracy the extremes of temperature (minimum and maximum) within which the plant can live without suffering serious damages to the vegetative apparatus; however, it is possible to confirm the high degree of adaptability of the species even to the occurrence of temperature decreases [16]. Therefore, considering the possible risks of thermal lowering in our country, the most suitable environments for the cultivation of pitahaya can coincide with those of prickly pear. Also with regard to water needs pitahaya has shown easy adaptability. As a matter of fact, despite its desert origins, it has proven to live well in humid tropical areas, such as some areas of Colombia, where precipitations of 2500 mm per year are recorded. However all the specialized plants of pitahaya should always be provided with an irrigation system in order to meet the water needs of the plant in the intervals between one rain and another in order to face possible drought periods. The critical period coincides with the maximum vegetative activity of the plant; in Italy from July to the end of August [17].

The plant, having a superficial root system, requires loose soils, where both water and oxygen circulate well; therefore soils suitable for cultivation are permeable and with perfect water drainage. In soils having a slow water drainage or subject to water stagnation, plants get sick of bacteriosis and other pathological forms caused by fungal parasites, which can lead, in most cases, to the death of plants because of collar rot. Loose and medium-textured soils are suitable, as long as they are well endowed with organic substance (2%) [1-18]. In clayey soils, on the contrary, it is necessary to assure a good drainage and, if necessary, to make some baulature. As far as the pH is concerned, the ideal range is between 6.5 and 5.5, therefore from sub-acidic to acidic. The plant proved to adapt well where it was possible to administer short shifts (2-3 days) of irrigation water during the hottest months (July-August). Vegetative development results were also interesting. It can therefore be deduced that sandy soils are very suitable for the



**Domenico Prisa**

cultivation of pitahaya [19]. In Colombia the soils where the cactacea is cultivated have a more clayey and silty texture compared to Italian cultivations (Table 1).

**PLANTS PROPAGATION**

Pitahaya is propagated almost exclusively by agamic means using the branches. The use of the seed is not a practicable method or at least it is not advisable because of the long time needed to obtain plants suitable for transplantation; moreover, plants reproduced by seed do not produce fruits with the same characteristics of the mother plant. The beginning of production is very late: sometimes 7 years pass from sowing; it is mainly for this reason that it is preferred to resort to agamic or vegetative reproduction. Mature branches are used, strong, formed the previous year or during the year, because they will be the support of the plant and portions of them are taken 20-30 cm long. A sterilized mixture of sand (30%), peat (30%), agroperlite (40%) or sand (40%) is usually used as a substrate. Cuttings do not need to be treated with a rhizogenic hormone prior to planting. Planting takes place between April and September. It is advisable to have 2-3 fungicide treatments done to avoid the onset of dangerous rotteness [1-20-21]. At the same time it is good to keep the substrate humid without, however, exceeding the water supply. A very popular method in Colombia is to raise the cuttings individually in polyethylene pots (diameter 14 cm); operating according to the indications given, the emission of the roots occurs within 2-4 to 6 weeks. It is necessary to keep in mind that the cuttings placed in a small pot can be planted after the rooting; if the cuttings should be left for a long period in the pots it is advisable to change the container using a bigger one. We also point out that normal ramifications can also be had on a branch of reduced cross section, even only 1 cm [22-23].

**SOIL PREPARATION AND PLANTING**

The preparation of the ground which will host the pitahaya plants is done in February-March, preferably by digging (60 cm) in order to create those conditions of aeration and easy percolation of water, both rain and irrigation, which are indispensable for the good development of the root system of the young plants. In any case, it is advisable to avoid bringing layers of soil of different structure and chemical composition to the surface [24]. The digging is followed by ploughing, which will be used to incorporate organic and mineral fertilizers into the soil. Pitahaya is a demanding plant as far as organic matter is concerned: it is advisable to use 100 tons/ha of well-matured manure or 4 tons/ha of organic soil conditioner from humified and partially dehydrated stable manure for the basic fertilization, while as far as phosphate and potassium mineral fertilizers are concerned, the dosages will have to come from the chemical-physical analysis of the soil in order to fill possible deficiencies. Complementary work will be carried out by the end of March to make the soil suitable to receive the young seedlings; while the planting for open field cultivation can be done in April-May [25].

**PLANT BREEDING FORMS**

In order to cultivate pitahaya it is necessary to choose the cultivation system and, as a consequence, the type of support structure needed, as the plant is not able to stand upright. The main forms of cultivation adopted in Colombia are: the pergola or "T bar", the espalier, the enclosure system. The same forms of cultivation can be considered valid for the cultivation in Italy as well; however, as in our country are common forms of cultivation for vine and kiwi awning, it is advisable to consider this form of cultivation as well. For small plantations the best forms of cultivation are espalier and modified pergola [26-27].

**PLANTS PRUNING**

Pruning of pitahaya must be considered fundamental in order to aim at the formation of the plant according to the chosen breeding system, as well as for an adequate production. The topping of the plant is usually done manually, branches which are excessively heavy, deteriorated and in an undesirable position must be eliminated [1]. All pruning interventions are done between spring and summer when the plant is in full vegetative activity. Pitahaya tolerates well the removal of branches, and it is able to easily emit new shoots. With the pruning we also tie the branches to the brace and to the galvanized iron wires of the scaffold, both because the pitahaya is not able to support itself, and in order to correctly set the form of breeding we have decided to adopt. Colombian technicians consider pergola training for pitahayas to be better than the other systems mentioned, because it is closer to the



**Domenico Prisa**

natural arrangement of the branches of the cactus. In fact, the branches arranged on a horizontal plane receive better sunlight; moreover, the pergola system facilitates the normal pruning and harvesting operations and the transit of mechanical means in the orchard inter-row [28-29].

**PITAHAYA CULTIVATION TECHNIQUES**

The root system of pitahaya is expanded, but superficial (it mainly develops in the first 20-30 cm of soil), therefore deep tillage should not be done. In order to control weeds or to bury fertilizers, light hoeing around the plants or in the whole field is necessary, limited to the first centimeters of depth in order not to risk to damage the most superficial roots of the cactus [30-31-32]. As far as organic fertilization is concerned, it is recommended to apply 25 tons/ha of well matured manure or 2,5 tons/ha of organic soil conditioner per year; or for each single plant it is possible to distribute about 2 Kg of organic soil conditioner. Particular attention should also be paid to mineral fertilization. Fertilizers should be distributed 30-50 cm from the stem, over an area of 1 m<sup>2</sup> for the first year of plant life. In the second and third year, fertilizer should be administered over an area of 2 m<sup>2</sup>; from the fourth year on, fertilizers should be distributed over the entire field. Irrigation during the periods of maximum plant activity must be frequent, avoiding occasional excesses in late autumn and winter [33]. A possible example of open field fertilization per hectare could be 450-600 kg of ammonium sulfate, 350-450 kg of mineral superphosphate, 240-300 kg of potassium sulfate.

**PITAHAYA IN POT**

Pitahaya lends itself well to be cultivated at home for ornamental purposes, provided it is grown in large pots (diameter 50 cm). The potted plant bears fruit in a few years: it is sufficient to use a good potting soil and keep the plants exposed to light, but sheltered from bad weather or sudden drops in temperature. The pitahaya grows well in an apartment at a temperature of 20°C and bears gradual drops down to -2°C. It is essential to use a brace to bind the plants, and the soil must remain damp. Liquid fertilizers used in floriculture lend themselves well to periodic (every 15 days) addition of the main fertilizers [34].

**HARVESTING AND ADVERSITY**

In its environment of origin a Pitahaya plant after 20 months from transplanting can produce 1-1,5 Kg of fruits; if the pedoclimatic conditions are ideal for the cultivation, in a hectare can be obtained 1,1-1,6 t; this production increases gradually so that a plantation in full production provides on average 10 t/ha of fruits.

Pitahaya fruit has an interesting commercial potential as it is characterized by high quality requirements. It is not by chance that Colombians have defined it as the best among the fruits produced in Colombia.

In Colombia the simplest method is to pick fruits having a homogeneous ripening, which is thus identified:

- fruits with 25% of the epicarp colored yellow and 75% green, are destined for foreign countries;
- fruits with 50% of the epicarp colored yellow and 50% green, are destined for the domestic market of Colombia.

Fruits are harvested wearing gloves made of sturdy material. The fruits, before being put on the domestic and international markets, are selected and cleaned of flower residues and thorns. The selection and packaging of fruits for marketing is done respecting the homogeneity of maturity of the same and that is: 25-50-75% referred to the yellow color of the epicarp [35]. For the exportation the fruits are packed in special cardboard boxes, where they are housed in special plastic alveoli. It is always convenient to cover the box with a polyethylene sheet, in order to maintain a suitable percentage of humidity to avoid the dehydration of the fruits and therefore their wrinkling. The net weight is 3 Kg. As for the frigoconservation it is good that the packed fruits are stored in a refrigerated environment at a temperature of 10 ° C, the storage time is around 3 weeks. The main diseases affecting the plant are fruit fly (*Anastrepha spp.*). The adult of this insect lays its eggs in the flower; afterwards the larvae invade the pulp causing the fruit's disintegration. Anthracnose (*Colletotrichum spp.*), fungal disease affecting branches and fruits, manifested by black circular spots [36].



**Domenico Prisa****PLANT NUTRITIVE VALUE**

Evaluation of fruit analysis (Table 2) showed that Pitahaya fruits contained average moisture (85 g/100 g), protein (1,1 g/100 g), lipid (0,40 g/100 g), vitamin C (20,5 mg/100 g), vitamin A (0,12 mg/100 g), ash (0,56 g/100 g), fibers (3,0 g/100 g), glucose (5,0 g/100 g), fructose (2,0 g/100 g), sorbitol (0,33 g/100 g), and carbohydrates (11,0 g/100 g). Pitahaya fruits also contain several minerals such as iron (1,9 mg/100 g), potassium (190 mg/100 g), niacin (3 mg/100 g), calcium (8,5 mg/100 g), magnesium (40,0 mg/100 g), phosphorus (22,5 mg/100 g), sodium (6,0 mg/100 g), and zinc (0.30 mg/100 g).

**MEDICINAL PLANT VALUE**

Today we know that the consumption of fruits and vegetables can serve to reduce the incidence of diseases in particular cancer and cardiological problems. The use of dragon fruit can be a strategy to reduce the incidence of diseases because the content of phytochemicals that have a positive impact on health is high. Especially the content of nutrients such as vitamin B<sub>2</sub>, vitamin B<sub>3</sub>, vitamin B<sub>1</sub>, vitamin C, fats, carbohydrates, proteins, betacyanins, polyphenols, iron, phytoalbumin, carotene, cobalamin, glucose and phenols. Pitahaya has positive effects on the digestive process, as an anti-diabetic, lowers blood pressure, neutralizes toxins in the body, especially heavy metal toxins, helps treat asthma as well as cough and prevents various types of cancer especially colon cancer [37].

Dragon fruit contains phytoalbumin which has a protective effect against cancer and the iron content scheme is also found in red dragon fruit is able to increase the levels of erythrocytes and hemoglobin so it can be used as a treatment for anemia [38]. In addition to the presence of polyphenols and flavonoids, there are also other phytochemicals in Pitahaya called betacyanins and betaxanthins that are part of the betalains. Studies show that betacyanins in dragon fruit have an action against free radicals. As is well known, free radicals damage the body. As they are capable of causing neurodegenerative diseases, aging or heart problems. The white dragon fruit (*Hylocereus undatus*) in the medical field plays a role in the wound healing process especially the leaves and water extract of the flowers which were mixed in topical preparations [39].

**ANTI-CANCER ACTIVITY**

Studies have shown that the presence of flavonoids, dibetanin and polyphenols in dragon fruit provide an anti-cancer effect. The skin of dragon fruit showed antiproliferative activity against human hepatocellular carcinoma cells in a single dose. Several researches have shown that the effect of polyphenols can affect antioxidant mechanisms, anti-inflammatory, inhibition of angiogenesis, cell cycle arrest and induction of apoptosis, and activation of protein kinases. Pitahaya red fruits contain lycopene, which is a natural antioxidant recognized for fighting cancer. Antioxidants protect cells from reactive oxygen species that can cause harmful effects and prevent the formation of cancer-causing free radicals. The flesh and skin of red pitahaya are rich in polyphenols and are a good source of antioxidants and while white pitahaya is richer in flavonoids [40].

**CONCLUSION**

*Hylocereus spp.*, commonly known as pitahaya or dragon fruit is one of the most important nutraceutical level fruits, widely consumed by the world community. The main cultivation areas of dragon fruit are located in Southeast Asia, America, Vietnam, Canary Islands and Thailand, but nowadays it is also gaining a lot of interest for its nutritional properties in European countries. Dragon fruit contains nutrients and phytochemicals that are good for health and protect against various degenerative diseases. The results of various researches show that dragon fruit has preventive activity for several diseases that affect humans, such as cancer, digestive problems, diabetes. So dragon fruit can be classified as a super fruit that has medicinal activities and can be used as an alternative to the use of chemical based drugs. Further studies however on dragon fruit are needed to confirm and expand the knowledge about the medicinal qualities of the plant and fruit for the prevention and alternative treatment of various diseases.



**Domenico Prisa****ACKNOWLEDGMENTS**

The research is part of the project “MicroSuc: microorganisms for the growth and protection of cacti and succulent plants”.

**REFERENCES**

1. O. Cacioppo Fico d'India e Pitaya. I libri di vita in campagna, L'informatore agrario, 1991
2. M.A. Balendres, Institute JCB. Diseases of dragon fruit (Hylocereus species): Etiology and current management options. *Crop Prot.* 126:104920, 2019
3. S.B.Kumar,R. Issac, M.L. Prabha. Functional and health-promoting bioactivities of dragon fruit. *Drug Invent Today.* 10, 2018
4. F. LeBellec, F. Vaillant, E.Imbert. Pitahaya (Hylocereus spp.): a new fruit crop, a market with a future. *Fruits.* 61(4):237-50, 2006
5. W.S.Choo, W.K. Yong. Antioxidant properties of two species of Hylocereus fruits. *Adv Appl Sci Res.* 2(3):418-25, 2011
6. R. Nurliyana,I. Syed Zahir,K. Mustapha Suleiman, M.R. Aisyah, K. Kamarul Rahim. Antioxidant study of pulps and peels of dragon fruits: a comparative study. Vol. 17, *International Food Research Journal.* p. 367-75, 2010
7. N. Lourith, M.Kanlayavattanukul. Antioxidant and stability of dragon fruit peel colour. *Agro Food Ind Hi Tech.* 24:56-8, 2013
8. N. Moshfeghi,O. Mahdavi,F. Shahhosseini,S. Malekifar, S.K. Taghizadeh. Introducing a new natural product from dragon fruit into the market. *Int J Recent Res Appl Stud.* 15(2):269-71, 2013
9. N.S. Ramli, P. Ismail, A.Rahmat. Influence of conventional and ultrasonic-assisted extraction on phenolic contents, betacyanin contents, and antioxidant capacity of red dragon fruit (Hylocereus polyrhizus). *Sci World J.* 1-8, 2014
10. A.A. Ariffin, J. Bakar, C.P. Tan, R.A. Rahman, R. Karim, C.C. Loi. Essential fatty acids of pitaya (dragon fruit) seed oil. *Food Chem.* 114(2):561-4, 2009
11. N. Nerdy, K.Manurung. Spectrophotometric method for antioxidant activity test and total phenolic determination of red dragon fruit leaves and white dragon fruit leaves. *Rasayan J Chem.* 11(3):1183-92, 2018
12. K. Thirugnanasambandham, V.Sivakumar. Microwave assisted extraction process of betalainfrom dragon fruit and its antioxidant activities. *J Saudi Soc Agric Sci.* 16:41-8, 2017
13. T. Perween, K.K. Mandal, M.A. Hasan. Dragon fruit: An exotic super future fruit of India. *J Pharmacogn Phytochem.* 7(2):1022-6, 2018
14. M.S. Sonawane. Nutritive and medicinal value of dragon fruit. *Asian J Hortic.* 12(2):267-71,2017
15. L. Xu,Y. Zhang, L.Wang. Structure characteristics of a water-soluble polysaccharide purified from dragon fruit (Hylocereus undatus) pulp. *Carbohydr Polym.* 146:224-30, 2016
16. W.Liaotrakoon. Characterization of dragon fruit (Hylocereus spp.) components with valorization potential. Doctoral dissertation, Ghent University; 2013
17. M. Joshi, B. Prabhakar. Phytoconstituents and pharmaco-therapeutic benefits of pitaya: A wonder fruit. *J Food Biochem.* 44(7):1-15, 2020
18. Y.D.O. Hernández, J.A.C. Salazar. Pitahaya (Hylocereus spp.): a short review. *Comun Sci.* 3(4):220-37, 2012
19. G. Block,B. Patterson, A.Subar. Fruit, vegetables, and cancer prevention: a review of the epidemiological evidence. *Nutr Cancer.* 18(1):1-29, 1992
20. D.P. Shekade,P.D. Patil, G.V.Mote, A.K.Sahoo. Potential use of dragon fruit and Taro leaves as functional food: a review. *Eur J Eng Sci Technol.* 1(1):10-20, 2018
21. S.B. Utomo, Y. Syukri, T.Redjeki. Phytochemical screening and analysis polyphenolic antioxidant activity of methanolic extract of white dragon fruit (Hylocereus undatus). *Indones J Pharm.* 23(1):60-4, 2012
22. O.P.S. Rebecca, A.N. Boyce, S.Chandran. Pigment identification and antioxidant properties of red dragon fruit (Hylocereus polyrhizus). *African J Biotechnol.* 9(10):1450-4, 2010





### Domenico Prisa

23. G.R.M. Perez, S.R.Vargas, H.Y.D. Ortiz. Wound healing properties of *Hylocereus undatus* on diabetic rats. *Phyther Res.* 19(8):665-8, 2005
24. G.C. Tenore, E. Novellino, A.Basile. Nutraceutical potential and antioxidant benefits of red pitaya (*Hylocereus polyrhizus*) extracts. *J Funct Foods [Internet].* 4:129-36, 2012
25. T.W. Zimmerman,C. Montilla, H. Harris, J. Gordon, R.Smart. Evaluation of 25 Pitaya Varieties in the United States Virgin Islands. *Agricultural Experiment Station* 20, 2017
26. T.K. Lim. *Edible medicinal and non-medicinal plants.* Dordrecht, The Netherlands: Springer 1: 285-292, 2012
27. S.R. Nurul, R.Asmah. Variability in nutritional composition and phytochemical properties of red pitaya (*Hylocereus polyrhizus*) from Malaysia and Australia. *International Food Research Journal* 21(4), 2014
28. A.A. Elobeidy.Mass propagation of pitaya (dragon fruit). *Fruits*, 61(5):313–319, 2006
29. I.H.L. Cavalcante, A.B.G.Martins.Effect of juvenility on cutting propagation of red pitaya. *Fruits* 63(5):277–28, 2008
30. Y.X.Hao, Z.G.Wang.Studies on introduction and cultivation techniques of red fresh dragon fruit in north of Zhejiang. *Agricultural Development Equipments*, 3: 134, 2014
31. L. Zhang, Z.M. Zhao, H.Y.Chen, Y. Zhang, H.Q.Li.Rapid propagation in vitro and domestication technique of tissue culture plantlets in pitaya. *Guizhou Agricultural Sciences* 44: 20-23, 2016
32. H.M. Rui, L.Y. Zhang,Z.W. Li, Y. Pan. Extraction and characteristics of seed kernel oil from white pitaya. *Journal of Food Engineering* 93: 482–486, 2009
33. B.Cui, S.Wu, S.H. Jiang, Y.T. Wang, S.Y. Niu, S.Z. Ye.Establishment of regeneration system on stems of *Hylocereus undatus* CV. Vietnam. *Northern Horticulture* 146–147, 2011
34. L.C. Donadio. Pitaya. *Revista Brasileirade fruticultura*, 31(3), 637-929, 2009
35. A. Omidzadeh, R.M. Yusof, A. Ismail, S. Roohinejad, L. Nateghi, M. Zuki. Cardioprotective compounds of red pitaya (*Hylocereus polyrhizus*) fruit. *J Food, Agric Environ.*; 9(3-4):152-6, 2011
36. E. M. Mercado-Silva. Pitaya—*Hylocereus undatus* (Haw). In *Exotic fruits*, Academic Press 339-349, 2018
37. S.S. Bobade, P.K. Nema, S. Nandi. Assessment of mass exchange during osmotic dehydration of dragon fruit. *Agricultural Engineering International: CIGR Journal* 18(2): 286-296, 2016
38. A.Haj Najafi, Y.A. Yusof, R.A. Rahman, A. Ganjloo, C.N. Ling. Effect of osmotic dehydration process using sucrose solution at mild temperature on mass transfer and quality attributes of red pitaya (*Hylocereus polyrhizus*). *International Food Research Journal* 21(2):625-630, 2014
39. T. Bozkurt1, S. İnan, İ. Dündar. Micropropagation of different pitaya varieties. *International Journal of Agricultural and Natural Sciences*, 13(1): 39-46, 2020
40. W. Liaotrakoon, N. De Clercq, V. Van Hoed, D. Van de Walle, B. Lewille, K.Dewettinck. Impact of thermal treatment on physicochemical, antioxidative and rheological properties of white-flesh and red-flesh dragon fruit (*Hylocereus* spp.) purees. *Food Bioprocess Technol.* 6(2):416-30, 2013

**Table 1 - Example of soil for Pitahaya growth**

Soil analysis for Pitahaya growth	Value
Soil structure	0,50 (%)
Fine soil	99,50 (%)
Clay	20,00 (%)
Silt	9,80 (%)
Total sand	70,00 (%)
pH	6,50
Total limestone	1,16 (%)





**Domenico Prisa**

**Table 2- Energy value and content of Pitahaya fruit per 100 g of pulp**

Energy value and contents	Value	Energy value and contents	Value
Calories (Kcal)	60,00	Fibers (g)	3,0
Water (%)	87,00	Cholesterol (mg)	0
Protein (g)	1,1	Ca (mg)	8,5
Lipid (g)	0,4	Fe (mg)	1,9
Mg (mg)	40,00	P (mg)	22,5
Vitamin B <sub>1</sub> (mg)	0,04	Vitamin C (mg)	20,5
Vitamin B <sub>2</sub> (mg)	0,05	Vitamin B <sub>3</sub> (mg)	0,16



**Figure 1 – Pitahaya plant**



**Figure 2 – Pitahaya stems and thorns**



**Figure 3 – Pitahaya roots**



**Figure 4 – Pitahaya fruits harvest and detail of the inside of the fruit**







## Analysis on Knowledge Information Management, Organizational Learning and Education

Sathyanarayana Kaliprasad<sup>1\*</sup>, K. N. Prashant kumar<sup>2</sup> and Trilochan Bhatt<sup>3</sup>

<sup>1</sup>Research Scholar, Ph.D Management, Lovely Professional University, Punjab, India.

<sup>2</sup>Assistant Professor, Department of Commerce, Indavara Dodda Siddalinge Gowda Government College, KM Road , Chickkamagaluru , Karnataka, India.

<sup>3</sup>Assistant Professor, Commerce, Government College, Nasrullaganj, Sehore, Madhya Pradesh, India.

Received: 23 Oct 2021

Revised: 23 Dec 2021

Accepted: 13 Jan 2022

### \*Address for Correspondence

Sathyanarayana Kaliprasad  
Research Scholar,  
Ph.D Management,  
Lovely Professional University,  
Punjab, India.



This is an Open Access Journal / article distributed under the terms of the **Creative Commons Attribution License** (CC BY-NC-ND 3.0) which permits unrestricted use, distribution, and reproduction in any medium, provided the original work is properly cited. All rights reserved.

### ABSTRACT

Educational institutions and universities are knowledge intensive service organization and are increasingly are exposed to marketplace pressures .The universities are expected to adapt to a newer model of teaching-learning processes with the arrival of the knowledge-based economy. Higher education is a knowledge-intensive activity; hence, the application of Knowledge Management to educational institutions assumes greater significance and this is particularly true for technical institutions, as these institutions perform many of the knowledge- centric activities like content creation, teaching-learning interactions, research activities, experimentation, consultancy services, process/product development, technology transfers, community and skill development activities, industrial/field visits and inspections, and inculcation of values.

**Keywords:** Digital technology, Knowledge Information, Learning, Online Education, Entrepreneurship.

### INTRODUCTION

A good teaching management system is necessary to ensure effective teaching. With the rapid development and popularization of vocational colleges, vocational colleges have received more and more attention from the society. With the expansion of higher vocational education, some problems have also followed, such as the positioning of the school, the characteristics of the school, and the recognition of enterprises .In the past, higher vocational education had a traditional school-oriented and enterprise-oriented stance in the school-running philosophy. Although this position has been well adapted to economic and social development in a certain historical stage. However, with the



**Sathyanarayana Kaliprasad et al.,**

continuous changes of the educational environment and social environment, this concept has hindered the innovation of educational management systems and operating mechanisms. Through data mining technology, some useful knowledge hidden behind a large amount of data can be discovered, and this knowledge can be used to guide managers to improve management methods and strengthen management in a targeted manner [1,2]. In the teaching and management of foreign schools, data mining has become an important tool to improve the level of teaching management and teaching quality, but the application of data mining in various industries

**Digital technology**

Nowadays, the world has entered the digital age. Digital technology has integrated into everyone's daily life, resulting in a wave of structural changes, patterns, production processes, and economic, social, trade, service and education activities throughout the world. Especially in the field of digital technology for education, it has directly affected in terms of teaching, research, and academic management as well as communication at all levels and day by day, the influence of digital technology will increase greatly. Many educational institutions worldwide have chosen to use digital technology for teaching and learning to help develop learners to have quality knowledge and the potential to be a part in driving the digital economy and society forward. In the 21st century with the rapid advancement of digital technology has resulted in the application of digital technology trends in education in a more diversified way, such as cloud technology, ubiquitous technology, block chain technology, Virtual Reality (VR), digital twin, artificial intelligence, learning analytics, adaptive learning, MOOCs As a result, teaching and learning with digital technology tends to be more online learning through the internet and cloud technology. Learning Management System is therefore an important tool to support learners of the digital era.

The complex challenges in the 21st century have called for engineers to response quite in different way from the norm of the conventional engineering practice where in the new global context it can be noticed that the role of engineers is changing .This is due to the change of the context of problem that they need to solve as it is very common that problems in the engineering practice nowadays involve collaborative interdisciplinary contexts .In such circumstances, it is depicted that engineers will have to acquire the combination of industry specific competencies and knowledge through a well-mixed of social skills, problem solving attitudes, project oriented mindset, and management style with entrepreneurial orientation as the foundation for developing further specializations, based on the emerging needs and opportunities .Such acquirement is very crucial for engineers as they are expected to meet economic and workforce needs and for that reason, the engineering schools nowadays are call to produce entrepreneurial engineers. In response to the call, a significant growth of entrepreneurship programs has been reported to have been offered to engineering students [3,4]

**Engineering and management**

It is important to note three major characteristics of this Open Design research approach: 1) both engineering and management are considered to focus on problem-solving (vs. problem-oriented and/or empirical), i. e., engineering management systems improvement and synthesis; 2) the acknowledgment that both engineering and management have to deal with real-life (physical) situations that limit the amount of degrees of freedom, i. e. reality provides feedback on human interventions to improve situations such that feasibility is of major importance; and 3) integrated management and engineering problems will have to be solved quantitatively modelled in order to recommend objective CME results (e.g., dynamic programming; systems dynamics, combinatorial simulation, structured expert judgment, artificial intelligence, etc.).Although the traditional teaching method has certain teaching effects, for the students of the Continuing Education College, the work business is busy, the idle time is unstable, and the requirements for face-to-face teaching cannot be completed on time. The promotion of online teaching resources is conducive to satisfying the students' time fragments. The requirements can make students make full use of the fragmented spare time. Students can actively participate in the study. The teacher is transformed from the "master" in the traditional teaching method to the role of "mentor", which also makes teaching resources and knowledge resources. Get the most out of it. In addition, this article has the following innovations[5,6]The present study is an applied investigation, carried out with the purpose of describing the current situation of the active research projects in the Faculty of Engineering[7].





**Sathyanarayana Kaliprasad et al.,**

### **Features And Advantages Of Block chain based Online Education**

Different from the traditional online education, the block chain-based education can ensure the equality between learners, educators, education institutions and the other parties. By means of timestamp and encryption algorithm, it can also ensure the authenticity of online learning and prevent the cheating and tampering with the relevant data. Therefore, we can say that the block chain-based online education can ensure an ideal effect and direct communication between the nodes on the blockchain. Though the blockchain technology has not been widely used in education, its debut in the management of online education is enlightening and far-reaching; as the block chain based online education has its special features and advantages

#### **A. Features of Block chain-based Online Education**

The block chain is based on distributed databases, which are linked together to form a network of different blocks. These blocks are chained chronologically. The block chain technology is mainly characterized by the decentralization, transparency, anonymity, traceability and immutability of network data, so it provides a new paradigm for the execution and management of online education, and makes the online education have such special features as follows:

- All the data supplied by education institutions, educators, learners and other parties will be recorded with timestamps. These timestamps preserve a chronological order between these data, showing their logical relationship and the exact time when they are generated. These data with timestamps can faithfully record the online activities of all parties involved, ensuring the authenticity of learning process, relevant certificates or the qualifications of learners.
- The block chain of online education is made up of distributed structure. This type of structure adopts decentralized protocols to ensure a complete record and storage of data, so all the information exchange between the nodes will be broadcast to the whole block chain. "In this structure, the trust between distributed nodes is built through mathematical methods rather than the centralized organizations"[4] The information of a node cannot be easily tampered with, as it is already distributed to all the other nodes on the chain and all the nodes will sync their ledgers. "Only when 51% nodes are controlled, can the data on the block chain be modified or deleted. If the information of a node is changed, it will be found out by all the other nodes on the block chain. In view of this, the information of each node is supervised by all the other nodes on the block chain"[8]

#### **Learning Management System**

The utilization of the internet as a means of online learning Science education online learning can be done by providing software LMS features that can support learning. Learning Management System is software that is created to make it easier to organize a college professor of learning and interacting with students who are not limited by space and time . LMS is a software package used to deliver learning materials and resources online web-based multimedia. The usage of the Learning Management System platform Moodle in teaching and learning can give learners access to learning materials in the controlled environment .The learning process can take place anywhere, monitor progress and keep a record of learning students, expanding class by providing online discussion, evaluation, events, collaboration as well as instruction communication. Learning Management System can manage to track and report interaction that occurs between students with the content of the materials and the learners with educators [9] .

Fig 1 The present higher education system has embraced many different modes of disseminating knowledge through distance education, online education, virtual universities, massive online open courses, flipped classrooms etc. The shared experience of co-education and collaborative growth consisting of traditional and modern cultures has forged unity among the global citizens. In this context, there is a need for improving the quality of education, providing flexibility, nurturing the spirit of innovation, endorsing multi-culturalism, promoting laboratory work, and encouraging entrepreneurship. The integrative model proposed in this paper has the potential to meet these requirements with the right combination of people processes and technology. While industries have adopted KM and TQM as survival tools, the higher educational institutions are yet to reap the rich benefits of imbibing these time-tested techniques. The proposed model has the potential to pave the way to success in this direction.



**Sathyanarayana Kaliprasad et al.,****Big Data Platform for College Education**

Big data analysis of data collected by existing business management systems, student management systems, library management systems, etc., through big data analysis from the effects of teacher teaching, the use of multimedia courseware, the number of students in class, and the situation of absenteeism The platform is analysed. It can provide decision support information for the teaching department, provide teachers with accurate feedback information, make it better to carry out teaching work, and improve teaching quality[10]

**Creating Synergies between Academic and Technical Team**

Developing online learning modules required coming together of academic and IT teams. Academic teams had faculty members who were experts and researchers in their respective fields of study but knew very little about the functionalities of the online platform. While the IT team did not much understand either the nuances of the subject or the art of teaching. IT team was more oriented towards the technical feasibility of a particular functionality while the academic team viewed it from students' perspective. Misunderstandings of semantic nature were quite frequent. To handle this issue, subject coordinators were made for all the seven subjects. These subject coordinators worked with faculty members on one end and the IT team on the other. This reduced the number of IT-academics interaction and since the same people interacted frequently they picked up each other's language fast[11-12].

**Course Content Quality**

For the first two semesters during the experiment, the entire online content was created in house by the faculty members as well as the IT team specially recruited for this purpose. There was hardly any overlap in the skill set of the two teams which reflected on the quality of the content. Though audio-video quality was good enough and all the documents were proof read before being uploaded but as compared to the resource available on some notable online learning platforms there was room for improvement. After one year of sincere effort it was finally decided to expand the e-learning team by hiring professional instructional designers. These designers are expected to make use of learning principles and best practices to improve the online content available to the students.

**Entrepreneurship education**

This paper began with discussing the prevalent problem of unemployment and un-employability and need for entrepreneurship education as a solution to the same. In order to fulfil the aim of the study, to analyse the different aspects of entrepreneurship education, three aspects have been studied here. Firstly the entrepreneurship education programs where it is found that the entrepreneurship programs are gaining popularity in higher education institutes. But the programs need to be different from the conventional educational programs as entrepreneurship involves more of lateral thinking or right brain thinking. Secondly, we have discussed about the teaching and assessment of entrepreneurship courses. Essentially the teaching has to be action oriented with focus on development of behavioural and attitudinal competencies. [13-16]. The learning can be enhanced through group discussions, workshops, presentations, solving cases studies, interacting with real entrepreneurs, developing business plan and implementation at later stages. The assessment techniques need to be different from the conventional system of examination as the learning outcomes are in the form of behavioural competencies and motivation. Lastly, the study highlights the significance of entrepreneurship education for non-business disciplines. Non-business disciplines are able to give birth to more number of start-ups as they have many product ideas, which they can convert into business ideas if they are equipped with knowledge of entrepreneurship. This study provides an insight into different aspects of entrepreneurship education programs for universities and other higher education institutes.

Academic staff is an essential part of higher education and they should be mobile to develop their students to meet the demands of society and employers. But a preliminary qualitative study of academic staff revealed the barriers that prevent them from being mobile. It appeared that part of the faculty needs support to create individual learning trajectories for developing necessary skills to become more successful in their professional sphere and fulfil their educational and research needs. Thus, an online information system should be developed to assist the academic staff to choose the appropriate professional development trajectory. Then, the question arises on how to use the potential of this online information system to the full to reach the needs of academic staff.



**Sathyanarayana Kaliprasad et al.,****Future work**

The main purpose to promote this idea is to promote the advancement and to accelerate integration of IT in the field of education by providing a modern, cost effective and a secure platform. In educational institutes having a large number of students that are enrolled or get admission in their respective institutions, but now it becomes difficult for institutes to manage their operations. The old pen and paper techniques of the past are simply not effective in this time and day. So, it makes sense for such institutes to make use of developing technology to make both their own and student lives easier. This can be done by deploying a multi-platform campus management solution that leverage the use of IoT, Augmented Reality and OBE based education platform. The main technologies that are integrated with TALEM System are OBE based-Education system, AR Technology, IoT based attendance system, Android and web-based Applications and Cloud database for secure usage and storage of information. Web Application and Mobile Application (Android) for both student, parents and teachers are also having the ability to communicate and share files, students are also able to check their progress and plan their study As, for example, in many countries and educational institutions, so-called "internal quality monitoring" is widespread. This is a regular questioning carried out 2-3 times a semester, a half of the year among students, as well as teachers and lecturers. The questionnaires contain dozens of questions relating to all aspects of the life of the educational institution - the quality of teaching each academic subject, textbooks and other educational materials, the objectivity of assessments, the state of the study rooms, the work of the library, workshops, canteen, bookstore, sports facilities, etc. and so on. For each question asked, the student gives an appropriate assessment (usually one of three or five – for example, very satisfactory, satisfactory, unsatisfactory and very unsatisfactory, below any standards). These questionnaires are processed on a computer and submitted to the management of the educational institution. The analysis of such questionnaires makes it possible to judge the activities of each teacher, lecturer, other employees and all services and take appropriate measures in a timely manner.

**CONCLUSION**

Knowledge Management is about managing the knowledge assets in an organization in an effective manner. Having an active Knowledge Management implementation has been proved to be beneficial to organizations regarding improving performance, faster decision making and learning Owing to its importance, Knowledge Management has now developed as a major discipline in the functional structure of modern-day organizations. In this era of knowledge economy, Knowledge Management has become crucial for organizational adaptation and survival as it enables them to learn from experience The success of modern-day organizations depends on how much knowledge they create and how fast they can commercialize it .

**REFERENCES**

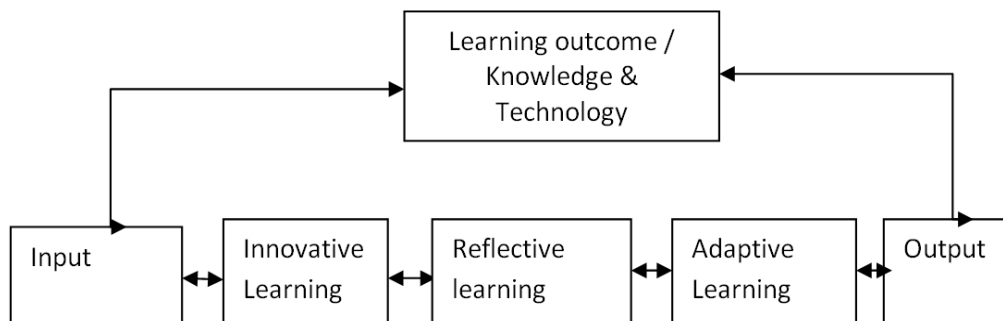
1. B. H. S. Thimmappa, F. G. Motlagh, D. K. Shetty, B. Rajendra, A. S. Pai and L. L. R. Rodrigues, "Development of an Integrated Knowledge and Technology Management Model for the Higher Education," 2019 International Conference on Automation, Computational and Technology Management (ICACTM), 2019, pp. 288-292, doi: 10.1109/ICACTM.2019.8776777.
2. W. Lu, "Research on Educational Management System and Operation Mechanism Based on Data Mining," 2020 International Conference on Computers, Information Processing and Advanced Education (CIPAE), 2020, pp. 39-42, doi: 10.1109/CIPAE51077.2020.00018.
3. P. Wannapiroon, N. Kaewrattanapat and J. Premsmith, "Development of Cloud Learning Management Systems for Higher Education Institutions," 2019 Research, Invention, and Innovation Congress (RI2C), 2019, pp. 1-6, doi: 10.1109/RI2C48728.2019.8999877.
4. C. L. Entika, M. K. Jabor, S. Mohammad and S. Osman, "Defining the Meaning of Entrepreneurship Education for Future Engineering Graduates," 2017 7th World Engineering Education Forum (WEEF), 2017, pp. 290-293, doi: 10.1109/WEEF.2017.8467166.





**Sathyanarayana Kaliprasad et al.,**

5. R. Binnekamp, A. R. M. Wolfert, O. Kammouh and M. Nogal, "The Open Design education approach - an integrative teaching and learning concept for management and engineering," 2020 IEEE Global Engineering Education Conference (EDUCON), 2020, pp. 756-762, doi: 10.1109/EDUCON45650.2020.9125161.
6. J. Cui, L. Zhu and C. Zhi, "Research and Design of Continuing Education Teaching Resource Database Based on IPv6," 2019 IEEE 4th Advanced Information Technology, Electronic and Automation Control Conference (IAEAC), 2019, pp. 1785-1789, doi: 10.1109/IAEAC47372.2019.8997769.
7. G. Cejas, A. Uema, J. José Vulcano and F. Camuzzi, "Baseline 2020 in engineering research projects in a private Institution of Higher Education," 2020 IFEES World Engineering Education Forum - Global Engineering Deans Council (WEEF-GEDC), 2020, pp. 1-5, doi: 10.1109/WEEF-GEDC49885.2020.9293674.
8. L. Gao, "Management of Online Education Based on Block chains," 2020 International Conference on Modern Education and Information Management (ICMEIM), 2020, pp. 84-89, doi: 10.1109/ICMEIM51375.2020.00026.
9. A. Wijastuti, M. V. Roesminingsih, F. Ardianingsih, S. Masithoh, E. Riyanto and S. J. Andajani, "Design Science Education for Student with Special Needs Use Learning Management System Platform Moodle," 2019 5th International Conference on Education and Technology (ICET), 2019, pp. 94-97, doi: 10.1109/ICET48172.2019.8987207.
10. Z. Wei and C. Jianbing, "Research on the Construction of Big Data Platform for College Education," 2019 IEEE International Conference on Computer Science and Educational Informatization (CSEI), 2019, pp. 230-232, doi: 10.1109/CSEI47661.2019.8938936.
11. A. Dwivedi, "Digitizing Academic Delivery in Higher Education Issues and Challenges," 2018 5th International Symposium on Emerging Trends and Technologies in Libraries and Information Services (ETTLIS), 2018, pp. 179-182, doi: 10.1109/ETTLIS.2018.8485251.
12. M. Mani, "Aspects of entrepreneurship education in higher education institutes," 2017 Tenth International Conference on Contemporary Computing (IC3), 2017, pp. 1-3, doi: 10.1109/IC3.2017.8284346.
13. K. N. Volchenkova, Y. S. Seriapina and I. A. Voloshina, "On-line Continuing Education for the Development of Faculty Academic Mobility," 2020 International Conference Quality Management, Transport and Information Security, Information Technologies (IT&QM&IS), 2020, pp. 628-632, doi: 10.1109/ITQMIS51053.2020.9322967.
14. JT. Mubeen, S. K. Hussain and F. Aqeel, "TALEM(The Advanced Learning and Education Management) System With OBE(Outcome-based Education)," 2019 International Conference on Information Science and Communication Technology (ICISCT), 2019, pp. 1-5, doi: 10.1109/CISCT.2019.8777424.
15. K. Berzina, I. Zicmane and J. Kuckovskis, "Self-assessment as a key criterion for increase of quality of higher education in modern conditions," 2017 International Conference on Electromechanical and Power Systems (SIELMEN), 2017, pp. 016-019, doi: 10.1109/SIELMEN.2017.8123373.
16. L. L. R. Rodrigues and A. Oommen Mathew, "Knowledge Management Technology, Knowledge Sharing and Learning - A Case Study," 2019 International Conference on Automation, Computational and Technology Management (ICACTM), 2019, pp. 273-276, doi: 10.1109/ICACTM.2019.8776779



**Fig. 1. An Integrated Approach to Management, Engineering and Technology**





## Displaced Narrative: Voicing the Self in Thuy's *Ru*

Tanuja Yadav\*

Associate Professor, Department of Languages, Manipal University Jaipur, Jaipur, Rajasthan, India.

Received: 08 Nov 2021

Revised: 13 Dec 2021

Accepted: 11 Jan 2022

### \*Address for Correspondence

**Tanuja Yadav**

Associate Professor,

Department of Languages, Manipal University Jaipur,  
Jaipur, Rajasthan, India.

Email: tanuja.yadav@jaipur.manipal.edu



This is an Open Access Journal / article distributed under the terms of the **Creative Commons Attribution License** (CC BY-NC-ND 3.0) which permits unrestricted use, distribution, and reproduction in any medium, provided the original work is properly cited. All rights reserved.

### ABSTRACT

The primary focus of the migrant writers is on their self in the host land due to the loss of identity and displacement. The migrant writings concentrate on the search of identity through the multiple narratives like displaced narrative, refugee narrative, memory narrative, historical narrative, autobiographical narrative etc. These narratives connect the two worlds: the homeland and the host land, the memories of the past life in Vietnam, in the refugee camp, and the present life. All these narratives give birth to the split or fragmented identity to the immigrants: liminal identity. Kim Thuy, a migrant writer of Vietnam origin in Canada wrote the novel *Ruin* poetic prose semi-autobiographical form. She has shared the experiences of the refugees who fled in the same boat with her family to an unknown path and future. She narrates the life of the refugees on boat and in the refugee camp in Malaysia through the memory narrative and the displaced narrative. This paper posits the portrayal of the quest for the reconstruction of identity through the displaced narrative. The displaced narrative of the novel highlights the experiences of the displacement and exile of the Vietnamese refugees as well as their life in Vietnam. It describes the sorrows, sufferings, and fear of the refugees in exile. The exotic experience of happiness of refugees at the warm welcome by the people of Canada at their arrival in Quebec gave them the satisfaction of being at the secured place. The acculturation of the Vietnamese refugees in the adopted land gave them the new identity. This newly emerged identity of the Vietnamese refugees in the host land is the fusion of the identity in the homeland and the new identity in the host land: the state of liminality. The displaced narrative paves the way for the new hermeneutic of the identity.

**Keywords:** Displaced narrative, Identity, Memory, Liminality, Displacement

### INTRODUCTION

Kim Thuy, a Vietnamese Canadian writer, immigrated in Quebec, Canada at the age of ten with her family due to the Vietnam war. The Vietnam war and the fall of Saigon in 1975 has compelled the Vietnamese to flee from Vietnam in

37746





### Tanuja Yadav

boats to escape the communist regime. Kim Thuy has used various narratives to unveil her past experiences at the childhood. These experiences have an everlasting impact on the memory of the child of ten years. The child who has not moved to any other place since birth, has been asked to leave the place of origin all of a sudden for an unknown time left the imprints of that period in the subconscious mind. The same has happened with Kim Thuy who has been connected and attached to her place of origin. Being a child, she was the silent observer at the moment when she has to flee with her parents. Even if she does not want to leave her home in Vietnam, she can do nothing. She observed each and every moment of the escape from the country of origin. All the moments collected and saved in her memory. The memories of displacement gave her the courage in her adult life to disclose the experiences of Vietnamese on boat and in the refugee camp. She recalls all the experiences of the moments of displacement and display them through the displaced narrative. The paper describes the use of displaced narrative to focus on the problems of identity, cultural trauma, trauma of war, and the struggle for the representation of self in the new land. The novel *Ru* is the portrayal of the life of the Vietnam refugees in Quebec, Canada. It is the first-person narrative. The life of refugees in Vietnam and then their life of displacement in refugee camp and Quebec has been described through the narration of the memories in words. The writing of the novel *Ru* is one of the strategy to come to terms with the displacement, exile, and the traumatic past of the life.

#### The New Hermeneutic of Self through Displaced Narrative

The displaced narrative is influenced and contextualized by the Vietnam War. This narrative is used to negotiate the identity. Paul Ricoeur has emphasized impacts of displacement on a person's "exchange of memories and in translation between cultures." (1996). The memory of the traumatic past helps in the reconstruction of the self and the identity. The historical narrative and the refugee narrative delineate the Vietnamese experiences of displacement. The displaced narrative unravels the emotions and feelings of the refugees from Vietnam. It describes the life led by the Vietnamese for complete one year as vagabond in the refugee camp and who are not aware of their future. The narrative plays an important role in the representation of self in the host country. According to Ronald Barthes, "Narrative is first and foremost a prodigious variety of genres, themselves distributed amongst different substances- as though any material were fit to receive a man's stories. Able to be carried by articulate language, spoken or written, fixed or moving images, gestures, and the ordered mixture of all these substances; narrative is present in myth, legend, fable, tale novella, epic, history, tragedy, drama, comedy, mime, painted ... stained glass windows, cinema, comics, news items, conversation. Moreover, under this almost infinite diversity of forms, narrative is present in every age, in every place, in every society; it begins with the very history of mankind and nowhere is nor has been a people without narrative. All classes, all human groups, have their narratives... Narrative is international, transhistorical, transcultural; it is simply there, like life itself" (Barthes 1977:79).

The narrative highlights the rupture of the emotional, temporal, spatial and cultural experiences in the life of the refugees. Thuy has tried to negotiate the identity of the refugees in the host land for their existence. Besides, she has tried to cope up with the experiences of the traumatic past through her narratives. For her, the writing is the best way to unveil the sufferings in order to lighten the heart and mind that have blocked the mind. Thus, opening the way for the new feelings and hopes for the life at present. According to Paul Ricoeur, a phenomenological hermeneutic philosopher, the person who tells the story "appears both as a reader and the writer of its own life" (1987, 246). Thus, Thuy has expressed not only her on own life through the novel but she is also the recipient of the interpretations and is being interpreted for her writings. The cultural and linguistic displacement emerged the emotional and mental stress among the refugees. The narrative of the memory leads to the dissociation of the trauma and the resilience to the migrant conditions. The narrative of displacement facilitates the acculturation and the enculturation among the refugees due to their acceptance by the host country, Canada. Kim Thuy has always shown her gratitude for the people of Quebec for the kindness shown by them, but her memories always take her back to her roots, her place of origin. The narrative of displacement is also the means of their existence in the other land. The narrative of the boat people attracts the attention of the people of host country and develop the sympathy for them. Perhaps the need of the attention of the host country for the refugees in Canada encourages Thuy to write about the life of the Boat people. The displaced narrative becomes the basis for the reconstruction of identity of the Vietnamese





**Tanuja Yadav**

refugees in Canada. Herbert Hirsch writes, "As an individual reconstructs his or her biography through memory, that biography becomes the basis for identity." Thuy has decoded the experiences of forced migration or exile of the Vietnamese through the displaced narrative of the memories. Her novel *Ru* displays the memories of the past in the fragmented form and there is no continuity in the narration of the memory and the story of the novel. She has narrated her story of the past and the present by intermingling the reality and fiction. The protagonist depicts the culture of her origin through the memories of her past life in Vietnam.

Lowenthal has stated that, "Those who bring more of their past into their present thereby both confirm their own identity and enrich the present with the past's amplified residues." Her fragmented memories echoes with the traumatic loss of belonging and identity. Her recounting of the past life reflects her psychological distress. The narrative of trauma and displacement works as a healer and remedy for the painful past. There is no chronological narrative progression in the novel. The author tried to give recognition, through her narratives, to self and the other refugees who arrived on boat with her. This memory narrative in the fragmented form is preparing the refugees at present to face the reality and reconstruct the identity while this narrative also prepares the coming generation to understand their past life and to live in the present with the memories of that past life. Thuy has reconstructed the past life in the story of the novel and relives it through the narrative of displacement and memory. The memory plays a vital role in the reconfiguration of the spatio-temporal narrative. The existence of the lost spaces in the memory connects the protagonist with her roots, the place of origin. It gives the strength to the protagonist that she is not the one without any past or the roots. She is not without any memories of happiness or memorable moments of her life. The deeply rooted memories of the childhood and her family in a palatial residence in Vietnam are reflected in the title of the first novel that is *Ru*. The meaning of the title is lullaby, a portrayal of the love and affection she had in her life in Vietnam. Thuy is unable to resist herself from putting the chunks of the Vietnamese language in her writings. The title of her novels is in Vietnamese language. The use of the language of origin gives her the satisfaction of sense of belonging for her country of origin.

The displaced narrative highlights the journey of Kim from the palatial residence of Vietnam to the refugee camp and homelessness and then again back to the place of resettlement in Quebec, Canada. Thuy remembers the cause of the displacement, the Vietnam war that insisted the Vietnamese to sail into the boats overloaded with the crowd as if they are the animals or objects. But at that moment the only reason behind is to escape the from the clutches of the communists and save their lives. The Vietnamese were not even aware of the route to which they have been moving, the unknown path. Thuy has depicted particularly the condition of women during this migration. She unwinds the hardships and sufferings of the Vietnamese woman during the war and after the war. She stated in the novel that, "We often forget about the existence of all those women who carried Vietnam on their backs while their husbands and sons carried weapons on theirs... Those women let their sadness grow in the chambers of their hearts. They were so weighed down by all their grief that they couldn't pull themselves up, couldn't straighten their hunched backs, bowed under the weight of their sorrow... the women continued to bear the weight of Vietnam's inaudible history on their backs. Ver often they passed away under that weight, in silence." (p.33)

The narrative of the novel explores the different ways of the life of the refugee before migration and after migration. The influence of the memory makes the narrative stronger by unveiling the moments that were not revealed by the historical narrative. The people are aware of the authenticity of the Vietnam war but the boat crisis with different stories happening at the same time outside and related to the war can only be painted by the person who has been among these boat people. The memory narrative of Thuy is subjective and we are looking to all the moments of the boat people crisis and the refugee camp through her narrative of the displacement and memory. The traumatic experiences of displacement from the homeland to hostland were individual as well as collective. Thuy narrates the experiences of the Vietnamese with whom she has been travelling in the boat with her parents. She could not narrate the traumatic experiences of the other boat people who have been captured and robbed by the pirates. There were the boats with the Vietnamese that could not reach any destination and were drowned or have been lost in the sea. Her displaced narrative has been limited to the memories of her family in Vietnam, the Vietnamese in the refugee camp and then the life in Quebec. The narrative emerged from her own experiences since her childhood. But the



**Tanuja Yadav**

childhood has the capacity of imagination and thus we can say that the portrayal of the boat crisis and life at the refugee camp has the mingling of the reality and imagination.

The traumatic consequences of Vietnam war, boat crisis and the refugee camp have distorted the identity. The dissociation of the memory has helped Thuy to develop the story of the novel through her displaced narrative. The displaced narrative also highlights the perception of the writer who is living in the host land. The writer now has two perceptions; one in which Thuy is looking at the Vietnamese life and the war memories as a Canadian and the other perception is when she is a Vietnamese woman and remembering her own people. In this way the narrative differs according to the point of perception. Who is saying what and for whom? Thuy's fragmented identity enabled her to give her mixed interpretation of the memories due to the double experience of the two cultures and the two countries. Her narrative of the war memories reflects not only the miserable conditions of the Vietnamese but also seeking the sympathy from the host land for the existence and identity of the refugees. The displaced narrative of the migration and war memories emerges an exotic feeling among the people of the host land. This narration of the memories of the past life in the homeland and the life in the host land brings the refugees closer to their homeland than to their host land. The Vietnamese refugees have never felt that vacuum in their life while living in the homeland what they experienced when they are in the host land. The memories of the homeland are enough for their living in the host country. The immigration into other land with different culture revives their need for the reconstruction of their identity.

**CONCLUSION**

The displaced narrative becomes powerful with the experiences of the war memories, trauma, loss and displacement in the life of the Vietnamese. The narrative explores the various representation of the identity of the refugees. The identity of the migrants as refugees due to their forceful migration and exile cannot escape from the roots of the origin, its culture, its memories. Thus, the migrants always find themselves intertwined in the culture of the host land and the homeland. The past history, stories, narratives, and the memories always survive in the present as an unending and incomplete moments. These memories and life story of the displacement are being told and retold to save them from being lost.

**REFERENCES**

1. Barthes, R. (1977) ' Introduction to the Structural Analysis of Narratives' in Image Music- Txt, translated by Stephen Heath, 79-124: New York: Farrar, Straus Giroux.
2. Hirsch, Herbert. (1995). *Genocide and The Politics of Memory*. London: Univ. of North Carolina Press. Print.133.
3. Lowenthal, D. (1985). *The Past Is a Foreign Country*. New York: Cambridge University Press.
4. Ricoeur, P. (1984). *Time and Narrative*. Chicago: University of Chicago Press.
5. Thúy, Kim.(2012). *Ru*. Trans. Sheila Fischman. Toronto: Vintage.
6. Thúy, K. (2012). *Ru: A novel*. Bloomsbury Publishing USA.
7. Winter, J. (2010). Introduction. *The Performance of the Past, Memory, History, Identity*. In K. Tilmans, V. V. Frank, & J. Winter (Eds.), *Performing the Past* (pp. 11–34). Amsterdam: Amsterdam University Press.





## Agro-Wastes for Aqueous Heavy Metal Mitigation: A Way toward Circular Economy

Shweta Vyas<sup>1\*</sup>, Preeti Soni<sup>2</sup>, Nguyen Thi Ha<sup>3</sup>, Tran Van Son<sup>4</sup>, Nguyen Minh Phuong<sup>4</sup> and Nguyen Manh Khai<sup>3</sup>

<sup>1</sup>Assistant Professor, Department of Pure and Applied Chemistry, University of Kota, Kota, Rajasthan, India.

<sup>2</sup>Research Scholar, Department of Pure and Applied Chemistry, University of Kota, Kota, Rajasthan, India

<sup>3</sup>Associate Professor, Faculty of Environmental Sciences, University of Science, Vietnam National University, Hanoi, Vietnam.

<sup>4</sup>Lecturer, Faculty of Environmental Sciences, University of Science, Vietnam National University, Hanoi, Vietnam.

Received: 21 Dec 2021

Revised: 03 Jan 2022

Accepted: 18 Jan 2022

### \*Address for Correspondence

#### Shweta Vyas

Assistant Professor,  
Department of Pure and Applied Chemistry,  
University of Kota, Kota,  
Rajasthan, India.  
Email: shwetavyas@uok.ac.in



This is an Open Access Journal / article distributed under the terms of the **Creative Commons Attribution License** (CC BY-NC-ND 3.0) which permits unrestricted use, distribution, and reproduction in any medium, provided the original work is properly cited. All rights reserved.

### ABSTRACT

Water Pollution due to non-biodegradable, toxic and persistent pollutants like heavy metals has been a challenging issue for researchers since ages; many researchers worked on this topic using conventional methodologies like filtration, sedimentation, coagulation, adsorption by implying suitable physical or chemical treatments. Among all, adsorption by Activated Carbon (AC) is found most versatile method, but it is expensive and regeneration of AC is a tedious task, hence the utilization of low-cost adsorbents for heavy metal mitigation has emerged as an interesting field of research. "Agro-Wastes" (AWs), obtained after removing the commercially useful parts of crops at agricultural fields are identified as raw waste materials for the production of low cost AC called as biochar, most commonly sugarcane bagasses, rice husks, coconut husks, banana peels etc., have been used for the removal of a variety of hazardous pollutants including heavy metals. Furthermore, wastewater treatment using AWs may be considered as a step toward waste management and a way for the Circular Economy (CE) wherein waste is considered as a resource. An overview on heavy metal pollution mitigation using some AW based adsorbents is reviewed here and introduced as a way towards CE concept.



**Shweta Vyas et al.,****Keywords:** Agrowaste Materials, Heavy Metals, Aqueous Pollution Mitigation, Biochar, Circular economy.

## INTRODUCTION

Availability of pure drinking water is signified as one of the basic needs for healthy survival of human beings on the Earth, the only planet gifted with more than 70% water on its surface. Unfortunately, with remarkable industrial revolution, water pollution has arisen as a global challenge and surety of pure water get diminished. Water pollution mitigation has always been the prime need of any healthy living culture system; therefore removal of hazardous pollutants from contaminated water has been reported as a topic of profound attention for researchers around the world. Conventional methods like sedimentation, filtration, chemical oxidation, biological treatment, coagulation, adsorption etc. have been utilized for water purification. Among all, adsorption is found most versatile [1] where Activated Carbon (AC) was employed as the universal adsorbent for the removal of various pollutants from contaminated water [2]. Although, adsorption on the surface of AC is recognized as an efficient process for pollution remediation, but once the activated sites available on the surface get blocked by contaminants its regeneration is essentially required, which is a tedious task and costly to be carried out at the bulk level [3]. To decrease the overall cost of the adsorption process, instead of using costly commercial AC, numerous waste materials have been introduced as adsorbents like agro-industrial wastes, food wastes, tire wastes etc. In agro based countries a bulk of waste generated i.e., "Agro-wastes" (AWs); the unwanted, useless or unsalable materials produced after removing the commercially useful parts of crops [4]. These AWs are either humped up on land sites or burnt openly, causing land and air pollution. Hence, using AWs as adsorbents for decontaminating water has proved to be a step towards remediation of pollution at all three levels- air, water & land, which can also economize the naturally available abandoned resources. AWs are reported as one of the best raw materials for the production of AC also called as biochar, accessible at bulk levels and biodegradable too[5]. Various types of AW materials such as wood apple shell, peanut shells, Rice husk, orange peels, melon peels, wheat husks, etc. were reviewed as cost-effective and eco-friendly adsorbents [6] for the removal of a variety of hazardous pollutants like heavy metals [7], dyes [8], organic pollutants [9], etc. These AW materials are carbon rich source and made up from lignocellulose; a complex combination of cellulose, lignin, hemicellulose, etc. with discrete ratio of each of the component [10]. Any physical treatment like vacuum heating, ball-milling, microwave irradiations, etc. or any chemical treatment with acid, alkali, oxidizing agents, salts etc. may alter this ratio and modify the surface activity of the agro wastes [11] which ultimately influence the adsorption capacity. Surface modified AWs have also been reported as efficient adsorbents [12] with higher adsorptive capacities to treat wastewater. The fate of treated wastewater plays a crucial role in the sustainable development of water sector. Actually, it has now been the prime need to develop sustainability in water sector to achieve Sustainable Development Goal-Six-SDG6 "Ensure availability and sustainable management of water and sanitation for all" [13]. Social, economical, and environmental sustainability in water sector can be achieved by introducing the concept of circular economy (CE); wherein wastes are considered as resources to maintain the close loop [14]. In some developed countries various model framework of CE has been proposed using approach of 6R- Reduction, Reclamation, Reuse, Recycling, Recovery, and Rethinking [15] and successful initiatives have already been taken for water pollution mitigation inculcating the concept of CE [16] and the treated water with required quality parameters has been reused in a number of ways viz. irrigation, aquaculture, industrial uses, potable water, sanitation, etc. [17]. In the current scenario, water sector demands to inculcate the policies of CE at small and medium scale industries for appropriate management of water.

### Agro-Wastes and Circular Economy Concept

Adsorption by Activated Carbon (AC) has accounted as the most efficient, cheap and easiest technology for pollution remediation. Commercial AC was mainly prepared by wood chips, low grade coal, and cork wastes; its regeneration is tedious task and economically less feasible process to be carried out at huge level. In the last few decades, Agro-wastes (AWs) were identified for the removal of various hazardous pollutants from water [18]. Further, advancement in nanotechnology has proven to be more effective way of utilizing AWs as its regeneration cost and





**Shweta Vyas et al.,**

processing become cheaper as compare to commercial AC [19]. Utilization of AWs to produce AC and adsorbents for wastewater treatment may be considered as a step toward waste management as well as a part of the Circular Economy (CE); wherein waste is considered as a resource. The desorbed spent adsorbent can be reuse, recycle, restored for next cycle and treated wastewater can be used for irrigation, aquaculture or industrial water supply to implement CE model; which would ultimately lead toward sustainability. The concept of CE may be utilized effectively for future advancement in water sector. At present, billions of people are incapable to get pure drinking water [20] at reasonable cost. Scientists have developed eco-friendly technologies using agro-wastes as low-cost bio-adsorbents for the effective removal of various hazardous pollutants from water [21]. Here in, overview on AW based adsorbents and removal of most commonly occurring pollutants using them is summarized.

### **Adsorbent Materials from Agro-Wastes**

Heaps of AWs belonging to rich source of cellulose, lignocelluloses, lignin, etc. have directly been employed for the pollutants removal [22-24]. The presence of lignin and silica in AWs' lignocellulose structure or the rich contents of amino and hydroxyl functional groups make these AWs favor for pollutants removal from water [25]. AWs materials are also carbon rich materials and thus utilized to prepare low-cost Activated Carbon (AC) known as biochars to be used as bio-adsorbents. Commercially available AC is prepared by using low grade coal, wood, or coconut shell as conventional raw materials. Raw materials used are the major factor to decide the cost and physio-chemical properties of prepared AC; since the nano porous network formation occurs by burning of the raw material, hence higher carbon precursors available at a cost-effective price were searched to maintain the quality of AC as well as the production cost [26]. Various AWs like wheat straw, rice husk, maize cob, etc. are carbon rich sources and thus reported as the best raw materials for the preparation of low-cost AC [27]. The characteristic properties of prepared AC depends up on many features like pore size distribution, functional groups present on surface of adsorbent, initial pH, temperature, particle size of adsorbent, etc. which influences the efficiency of adsorption processes [28-29]. The uptake capacity and stability of biomaterials found to be enhanced by physical (heat drying and pyrolysis) and chemical modifications with inorganic/organic acids, base, activators or oxidizing agents [30-34]. Pyrolysis and acid treatment are frequently chosen to improve capacity of bio sorbents. Pyrolysis is a good method for increasing surface area [35]. After modification, surface area and morphology of bio-sorbent become much more favorable for pollutants abatements [36].

### **Applications of AWS as Bio-Adsorbents for Mitigation of Heavy Metals**

Agricultural wastes (AWs) have been reported as an effective adsorbent for the removal of heavy metals [37-39] such as  $Pb^{2+}$ ,  $Cr^{6+}$  and  $Ni^{2+}$  ions were removed from aqueous by using *Brassica Campestris* stems; effect of various parameters were investigated to find the optimal conditions for highest adsorption efficiency of 98, 91 and 49% for  $Pb^{2+}$ ,  $Cr^{6+}$  and  $Ni^{2+}$ , respectively [40]. As per the study of Bansal et al., Chromium( $CrVI$ ) was removed from synthetic wastewater using rice husk that was pre-treated by boiling and formaldehyde treatment, the removal efficiencies were found around 70-75% for both materials at acidic pH 2 and adsorbent dose of 20 g/L [41]. In another study, agricultural waste materials such as wheat, corn, sugarcane and bajra etc. were used as adsorbents to reduce heavy metals, where bajra was found significantly effective in the process of eliminating toxic copper ions from aqueous solution by up to 98% [42]. By using a systematic "Design of Experiments" (DOE) approach, Asim et al (2020) evidently proved that agricultural waste materials such as alkali-treated coconut coir can act as fivefold more effective adsorbent material for Copper ( $Cu II$ ) removal with increasing water and moisture absorption properties by 27 and 30%, respectively [43]. M. B. Desta carried out Batch-adsorption techniques for the study of adsorption of heavy metals onto Activated Teff Straw (ATS); remediation of heavy metals such as Ni, Cd, Cu, Cr and Pb occurred quickly, achieving an absorption equilibrium after about 60 minutes batch run and following the Langmuir isotherm [44]. U. Garg et al. checked the feasibility of different agricultural waste such as sugarcane bagasse, maize corncob and *Jatropha* oil cake for the removal noxious metals like Chromium ( $Cr VI$ ) and Cadmium ( $Cd II$ ) from aqueous solutions [45]. Cotton stalks and apricot seeds were utilized in order to remove Copper ( $Cu II$ ) and Lead ( $Pb II$ ) in water [46]. P. S. Kumar et al. provided evidence that cashew nut shell can work as a cost-effective adsorbent to eliminate Cadmium ( $Cd II$ ) ions in acidic conditions within 30 minutes. Various isotherms like Langmuir, Freundlich, Temkin and Dubinin-Radushkevich, Redlich-Peterson, Koble-Corrigan, and Toth and Sips were studied



**Shweta Vyas et al.,**

to identify the kinetic equations parameters. As findings, the pseudo-second order equation was used to describe the Freundlich adsorption pattern [47] for the removal of Cadmium (CdII). M.M. Rao et al. [47] investigated the feasibility of activated carbons prepared from Ceiba pentandra hulls for the removal of Lead (Pb II) and Zinc (Zn II) from water and shown 90% efficiency within 50 minutes. Similarly, Ceiba pentandra hulls, Phaseolus aureus hulls and Cicer arietinum waste [48] were used for the removal of Mercury (Hg II) from water. The mechanism of removal of heavy metals depends upon the surface functional groups available on AWs such as carboxylic, phenolic, alcoholic, etc. which may have strong affinity for heavy metal ions by electrostatic attraction, ion exchange, metal complexation or chelation, physical or chemical adsorption, etc. [49]. In order to use AWs in bulk level, some challenges will have to be faced such as search of novel reagents for modification of AWs with multi-functional approach, cost effective method-development, and applicability of AWs under mixed metal solutions or real effluent systems [50].

### Regeneration and Reuse of Spent Adsorbents Materials

The strategies for Sustainability and Circular Economy (CE) highly demand for the concept of reuse, regenerate, and recycle. Thus to maintain such strategies, adsorbent regeneration by desorption process was introduced to extend the duration of the adsorbent life cycle with recovering the metals [51]. Most commonly, the used adsorbents have been regenerated by thermal desorption (heat) or base or/and acid treatments [52] for example the process of Copper adsorption-desorption was effectively carried out up to seven cycles with 94% desorption/ recovery of Copper [53]. Variety of eluents have been used for desorption purposes for example precious metal like Thorium (Th IV) was recovered by treatment with nitric acid [54], hydrochloric acid, sodium hydroxide, ethylenediamine tetra-acetate etc. have been utilized for the desorption of different metal ions [55] during this process simultaneous hydrolysis of the functional groups present on the biomass may occur thus the selection of eluent and temperature should be done carefully so that desorbing process may regenerate the adsorbent with maintained physico-chemical properties of adsorbents.

## CONCLUSION

Under the circumstances of drinking water scarcity in many countries over the world, using low cost AWs based adsorbents for mitigation of aqueous heavy metal pollution would be a boon to the water sector and reuse of the desorbed material and recovered metals will prove to be a beneficial way for social, economical, and environmental development for the establishment of Circular Economy (CE) for water resources. Meanwhile, adopting the concept of regeneration of AW adsorbents and practice to reuse the recovered metals and treated water at building, small community (rural sector) or societal level (urban sector) can transform a small unit of water sector to Circular economy (CE) model. However, technological advancements in wastewater treatment and standards/regulations for controlling the water quality of the treated wastewater must be optimized to establish these benefits and minimize the potential risks for human health and the environment.

## ACKNOWLEDGEMENTS

The authors are thankful to Science and Engineering Research Board, Department of Science and Technology, New Delhi for providing financial support under ASEAN-India Collaborative project scheme (IMRC/AISTDF/CRD/2018/0000062) of Government of India.

## REFERENCES

1. I.Ali and V.Gupta, "Advances in water treatment by adsorption technology", *Nature Protocol* 1(6): pp.2661-66, 2006.
2. B.Sadashiv and M.Shivashankar, History, "Method of Production, Structure and Applications of Activated Carbon", *IJERT*, 6(6): pp.495-98, 2017.





**Shweta Vyas et al.,**

3. L.L.Jae and O.Mitsumasa, "Regeneration of granular activated carbon using ultrasound" *Ultrasonics Sonochemistry* 12: 277–282, 2005.
4. F. O. Obi, B. O. Ugwuishiwu and J. N.Nwakaire, "Agricultural Waste Concept, Generation, Utilization and Management," *Nigerian Journal Of Technology* 35(4): pp.957 – 964, 2016.
5. Mohd. Sulyman, J. Namiesnik, A. Gierak, "Low-cost Adsorbents Derived from Agricultural By-products/Wastes for Enhancing Contaminant Uptakes from Wastewater: A Review", *Pol. J. Environ. Stud.*, 26 (2): pp.479-510, 2017.
6. R.Remmani, R.Makhloufi, M.Miladi, A.Ouakouak, AR Canales, D.Núñez-Gómez, "Development of Low-Cost Activated Carbon towards an Eco-Efficient Removal of Organic Pollutants from Oily Wastewater." *Pol. J. Environ. Stud.* 30(2): pp.1801-1808, 2021.
7. K.S.Bharathi and S.T.Ramesh, "Removal of dyes using agricultural waste as low-cost adsorbents: a review." *Applied Water Science* 3(4): pp.773–790, 2013.
8. N.N.Bandela, M.G.Babrekar, O.K.Jogdand, K.Geetanjali, "Removal of Copper from aqueous solution using local agricultural wastes as low-cost adsorbent." *J. Mater. Environ. Sci.* 7(6): pp.1972-1978, 2016.
9. N.A.Baharum, M.N.Hanisah, Y.I.Mohd, et al., "Highly efficient removal of diazinon pesticide from aqueous solutions by using coconut shell-modified biochar." *Arabian Journal of Chemistry* 13: pp.6106–6121, 2020.
10. C.Ververis, K. Georghiou, D. Danielidis, et al. "Cellulose, hemicelluloses, lignin and ash content of some organic materials and their suitability for use as paper pulp supplements." *Bioresource Technology* 98: pp.296–301, 2007.
11. G.Mahajan and D.Sud, "Modified agricultural waste biomass with enhanced responsive properties for metal-ion remediation: a green approach", *Appl Water Sci* 2:299–308, 2012.
12. A.A.Inyinbor, F.A. Adekola, G.A.Olatunji, "Microwave-assisted urea modified crop residue in Cu<sup>2+</sup> scavenging", *Heliyon* 6: e03759, pp.1-8, 2020.
13. UNGA ,United Nations General Assembly, "Transforming Our World: The 2030, Agenda for Sustainable Development," *Seventieth Session Agenda*, items 15 and, 116, 2015.
14. N.S.Kakwani, P.P.Kalbar, "Review of Circular Economy in urban water sector: Challenges and opportunities in India." *J Environ Manage.*, 271:111010, pp.1-37, 2020.
15. M.Smol, C.Adam, M.Preisner, "Circular economy model framework in the European water and wastewater sector," *Journal of Material Cycles and Waste Management*, 22: pp.682–697, 2020.
16. J.Fiksel, S.Praveena, R. Kavya, "Steps toward a resilient circular economy in India," *Clean Technologies and Environmental Policy* 23:pp.203–218, 2021.
17. P.Amerasinghe, R.M.Bhardwaj, C.Scott, K.Jella, F.Marshall, "Urban wastewater and agricultural reuse challenges in India. Colombo, Sri Lanka: International Water Management Institute (IWMI)." *IWMI Research Report*, 147, pp.36: 2013.
18. V.K.Gupta, P.J.M.Carrott, M.M.L.Ribeiro, and Suhas, "Low-Cost Adsorbents: Growing Approach To Wastewater Treatment—A Review", *Critical Reviews In Environmental Science And Technology*, 39:pp.783–842, 2009.
19. M.Jain, M.Yadav, T. Kohout, M.Lahtinen, V. K. Garg, M.Sillanpää, "Development of iron oxide/activated carbon nanoparticle composite for the removal of Cr(VI), Cu(II) and Cd(II) ions from aqueous solution," *Water Resources and Industry* 20: pp.54–74, 2018.
20. Mekonnen and Hoekstra, "Four Billion People Facing Severe Water Scarcity," *Science Advances* , 2 (2): E1500323, 2016
21. S.M.Abegunde, K.S.Idowu, O.M.Adejuwon, T.Adeyemi-Adejolu, "A review on the influence of chemical modification on the performance of adsorbents", *Resources, Environment and Sustainability* 1:100001, 2020.
22. Z.Aksu, "Application of biosorption for the removal of organic pollutants: a review." *Process biochemistry* 40(3-4): 9pp.97-1026, 2005.
23. A.Abdolali, W.S.Guo, H.H.Ngo, et al. "Typical lignocellulosic wastes and by-products for biosorption process in water and wastewater treatment: a critical review." *Bioresource technology* 160: pp.57-66, 2014.
24. T.Ahmad, M.Rafatullah, A.Ghazali et al. "Removal of pesticides from water and wastewater by different adsorbents: a review." *Journal of Environmental Science and Health, Part C* 28(4): pp.231-271, 2010.
25. V.S.Tran, H.H.Ngo, W.Guo, et al. "Typical low cost biosorbents for adsorptive removal of specific organic pollutants from water," *Bioresource Technology* 182: pp.353-363, 2015.



**Shweta Vyas et al.,**

26. S.Ana, Mestre and Ana P. Carvalho, "Nano porous Carbon Synthesis: An Old Story with Exciting New Chapters." *Intechopen*, 72476,2018.
27. B.Jorge, P. Garzon, G.Aviles, etal." A Review on the Synthesis and Characterization of Biomass-Derived Carbons for Adsorption of Emerging Contaminants from Water." *Journal of Carbon Research* 4 (4): pp.63-69; 2018.
28. B.B.Mathew, "Role of Bioadsorbents in Reducing Toxic Metals." *Journal of Toxicology* 2016: pp.1-13, 2016.
29. Saman et al."Surface modifications of agro-waste biomass for Hg(II) and MeHg(II) removal from aqueous solution,oilfield produced water and natural gas condensate." *Environ. Earth Sci.* 75:pp.345-54, 2016.
30. Z.Abdeen and S.G.Mohammad,"Study of the adsorption efficiency of an eco-friendly carbohydrate polymer for contaminated aqueous solution by organophosphorus pesticide." *Open Journal of Organic Polymer Materials*, 4: pp16 – 28, 2013.
31. R.Li, Y. Zhang, W.Chu, etal. "Adsorptive removal of antibiotics from water using peanut shells from agricultural waste." *RSC Advances* 8(24): pp.13546–13555, 2018.
32. G.K.Nagda, A.M.Diwan, and V.S.Ghole, "Potential of tendu leaf refuse for phenol removal in aqueous systems." *Applied Ecology and Environmental Research* 5(2): pp.1-9, 2007.
33. Z.Xi and B.Chen,"Removal of polycyclic aromatic hydrocarbons from aqueous solution by raw and modified plant residue materials as biosorbents." *Journal of Environmental Sciences* ,26(4): pp.737-748, 2014.
34. S.M.Yakout and A.A.M.Daifullah,"Removal of selected polycyclic aromatic hydrocarbons from aqueous solution onto various adsorbent materials." *Desalination and Water Treatment* 51(34-36):pp.6711-6718,2013.
35. S.G.Mohammad, "Biosorption of pesticide onto a low cost carbon produced from apricot stone (*Prunus armeniaca*): equilibrium, kinetic and thermodynamic studies." *Journal of Applied Sciences Research* ,9(13): pp 6459-6469, 2013.
36. S.Valili, etal. "Phenanthrene removal from aqueous solutions using well-characterized, raw, chemically treated, and charred malt spent rootlets, a food industry by-product." *Journal of Environmental Management*, 128: pp.252-258, 2013.
37. N.A.Khan, S.Ibrahim,P.Subramaniam, "Elimination of Heavy Metals from Wastewater Using Agricultural Wastes as Adsorbents." *Malaysian Journal of Science* 23: pp.43 -51,2004.
38. M.A.Renu etal. "Removal of heavy metals from wastewater using modified agricultural adsorbents." *Materials Today: Proceedings*, 4(9): pp.10534–10538,2017.
39. P.S.Kumar etal."Removal of cadmium(II) from aqueous solution by agricultural waste cashew nut shell." *Korean Journal of Chemical Engineering*, 29(6): pp756–768, 2012.
40. R. Baby Shaikh, B.Saifullah, F.Rehman, R.Iqbal Shaikh, "Greener Method for the Removal of Toxic Metal Ions from the Wastewater by Application of Agricultural Waste as an Adsorbent." *Water*, 10(10): pp.1316-23, 2018.
41. M. Bansal, U.Garg, D. Singh, & V. K. Garg,"Removal of Cr(VI) from aqueous solutions using pre-consumer processing agricultural waste: A case study of rice husk." *Journal of Hazardous Materials*, 162(1): pp.312–320,2009.
42. N.N.Bandela, etal., "Removal of Copper from aqueous solution using local agricultural wastes as low-cost adsorbent." *J. Mater. Environ. Sci.* 7(6): pp.1972-1978, 2016.
43. N.Asim etal., "Development of effective and sustainable adsorbent biomaterial from an agricultural waste material: Cu(II) removal." *Materials Chemistry and Physics*, 249: 123128, 2020.
44. M.B.Desta, "Batch Sorption Experiments: Langmuir and Freundlich Isotherm Studies for the Adsorption of Textile Metal Ions onto Teff Straw (*Eragrostis tef*) Agricultural Waste." *Journal of Thermodynamics*: pp.1–6, 2013.
45. S.Kahraman, N.Dogan,& S.Erdemoglu, "Use of various agricultural wastes for the removal of heavy metal ions." *International Journal of Environment and Pollution*, 34(1/2/3/4): pp.275, 2008.
46. P.S.Kumar, etal., "Removal of cadmium(II) from aqueous solution by agricultural waste cashew nut shell." *Korean Journal of Chemical Engineering*, 29(6): pp.756–768, 2013.
47. M.M.Rao etal. "Activated carbon from *Ceiba pentandra* hulls, an agricultural waste, as an adsorbent in the removal of lead and zinc from aqueous solutions." *Waste Management*, 28(5): pp.849–858, 2008.
48. M.M.Rao etal. "Removal of mercury from aqueous solutions using activated carbon prepared from agricultural by-product/waste." *Journal of Environmental Management* 90(1): pp.634–643, 2009.
49. X.Yang etal."Surface functional groups of carbon-based adsorbents and their roles in the removal of heavy metals from aqueous solutions: A critical review." *Chem Eng J.*:366:pp.608-621, 2019.







**Shweta Vyas et al.,**

50. Nguyen T.A.H., H.H. Ngo, W.S. Guo, J. Zhang, S. Liang, Q.Y. Yue, Q. Li, T.V. Nguyen (2013) Applicability of agricultural waste and by-products for adsorptive removal of heavy metals from wastewater. *Bioresource Technology* 148: 574-585.
51. Z.Li, etal. "One step synthesis of Co/Cr-codoped ZnO nanoparticle with superb adsorption properties for various anionic organic pollutants and its regeneration." , *J. Hazard. Mater* 352: pp.204–214, 2018.
52. I.K.Shah, Pra Pascaline, J.A.Babu,"Regeneration of Adsorbent Spent with Volatile Organic Compounds (Vocs)," *International Conference on Environment and Industrial Innovation, Ipcbee, Singapore* Vol.12,pp. 55-59, 2011.
53. M. A. Hossain, etal. "Removal of Copper from Water by Adsorption onto Banana Peel as Bio adsorbent." *Int. J. of GEOMATE*, 2(2): pp.227 -234, 2012.
54. S. Sayed Ahmed, etal. "Date seed as an efficient, eco-friendly, and cost-effective bio-adsorbent for removal of thorium ions from acidic solutions." *Aswan University Journal of Environmental Studies*, 1 (1): pp.106-124, 2020.
55. K.Gupta, A.Nayak, S.Agarwal,"Bioadsorbents for remediation of heavy metals: Current status and their future prospects" . *Environ. Eng. Res*; 20(1): pp.1-18,2015.





## Similarity Measure on Interval Valued Picture Fuzzy Soft Set

S.Anita Shanthi<sup>1\*</sup> and M. Gayathri<sup>2</sup>

<sup>1</sup>Associate Professor, Department of Mathematics Annamalai University, Annamalainagar - 608 002, Tamil Nadu, India

<sup>2</sup>Research Scholar, Department of Mathematics Annamalai University, Annamalainagar - 608 002, Tamil Nadu, India

Received: 17 Nov 2021

Revised: 19 Dec 2021

Accepted: 11 Jan 2022

### \*Address for Correspondence

**S.Anita Shanthi**

Associate Professor,  
Department of Mathematics  
Annamalai University,  
Annamalainagar - 608 002  
E.Mail: shanthi.anita@yahoo.com



This is an Open Access Journal / article distributed under the terms of the **Creative Commons Attribution License** (CC BY-NC-ND 3.0) which permits unrestricted use, distribution, and reproduction in any medium, provided the original work is properly cited. All rights reserved.

### ABSTRACT

This paper deals with similarity measure on interval valued picture fuzzy soft set (IVPFSS). The concept of Hausdorff distance between IVPFSS is defined and established to be a metric. Depending on this distance a procedure for similarity measure on IVPFSS is developed and illustrated by an example.

**Keywords:** Interval valued picture fuzzy soft set, Hausdorff distance, similarity measure

## INTRODUCTION

Fuzzy set theory was introduced by Zadeh [21] and extended to IFS by Atanassov [3,4,5]. Di Ke et al. [10], Zhizhen Liang et al. [12], Eulalia Szmidt et al. [18] and Muthukumar et al. [15] defined similarity measures on IFS. Hoang Nguyen [16] introduced knowledge based measure on IFS. Muhammad Jabir Khan et al. [11] dealt with distance and similarity measure of GIFSSs. Muharrem Dugenci [9] and Yuanna Liu et al. [13] developed generalized distance measure for IVIFS. Anita Shanthi et al. [1,2] discussed similarity measure on IVPFSSRT and applied it to decision making problems. The concept of PFS was introduced by Cuong [6,7]. Le Hoang Son [17], Nguyen Van Dinh et al. [8], Guiwu Wei [20], Nguyen Xuan Thao [19], Ruirui Zhao [22] and Luo et al. [14] introduced distance, dissimilarity and similarity measures between PFSs. Based on these concepts similarity measure on IVPFSS is introduced.

**Definition 1.1.** Let  $X = \{\xi_1, \xi_2, \dots, \xi_j\}$  be the Universal set,  $E = \{\varepsilon_1, \varepsilon_2, \dots, \varepsilon_j\}$  a set of parameters and

$(P_F, A), (P_G, B)$  IVPFSS on  $X$ . Hausdorff distance between  $(P_F, A)$  and  $(P_G, B)$  is

$$PH_d((P_F, A), (P_G, B)) = \frac{1}{6mn} \left\{ \sum_{m=1}^i \sum_{n=1}^j \max(|\underline{\mu}_{P_F(\varepsilon_i)}(\xi_j) - \underline{\mu}_{P_G(\varepsilon_i)}(\xi_j)| - |\bar{\mu}_{P_F(\varepsilon_i)}(\xi_j) - \bar{\mu}_{P_G(\varepsilon_i)}(\xi_j)|) \right\}$$





**Anita Shanthi and Gayathri**

$$\begin{aligned}
 & \left| \underline{\eta}_{P_F(\xi_j)} - \underline{\eta}_{P_G(\xi_j)} \right| - \left| \overline{\eta}_{P_F(\xi_j)} - \overline{\eta}_{P_G(\xi_j)} \right| \\
 & \left| \underline{\nu}_{P_F(\xi_j)} - \underline{\nu}_{P_G(\xi_j)} \right| - \left| \overline{\nu}_{P_F(\xi_j)} - \overline{\nu}_{P_G(\xi_j)} \right| \\
 & \left| \underline{\pi}_{P_F(\xi_j)} - \underline{\pi}_{P_G(\xi_j)} \right| - \left| \overline{\pi}_{P_F(\xi_j)} - \overline{\pi}_{P_G(\xi_j)} \right| \}.
 \end{aligned}$$

**Definition 1.2.** Let  $(P_F, A)$  and  $(P_G, B)$  be two *IVPFSS* over  $U$ . Similarity measure between  $(P_F, A)$  and  $(P_G, B)$  is

$$PS_m((P_F, A), (P_G, B)) = \frac{1}{1 + PH_d((P_F, A)(P_G, B))}$$

**THEOREM 1.3.** Consider the set of all *IVPFSS* ( $U$ ) over  $U$ . Then the Hausdorff distance function  $PH_d$  from *IVPFSS* ( $U$ ) to the set of positive real numbers is a metric.

**PROOF :**

Let  $(P_F, A), (P_G, B)$  and  $(P_H, C)$  be three *IVPFSS* ( $U$ ) over  $U$ .

(i)  $PH_d((P_F, A), (P_G, B)) > 0$  follows from Definition 1.1.

(ii)  $PH_d((P_F, A), (P_G, B)) = 0$

$$\begin{aligned}
 \Leftrightarrow & \max(|\underline{\mu}_{P_F(\xi_j)} - \underline{\mu}_{P_G(\xi_j)}| - |\overline{\mu}_{P_F(\xi_j)} - \overline{\mu}_{P_G(\xi_j)}| \\
 & |\underline{\eta}_{P_F(\xi_j)} - \underline{\eta}_{P_G(\xi_j)}| - |\overline{\eta}_{P_F(\xi_j)} - \overline{\eta}_{P_G(\xi_j)}| \\
 & |\underline{\nu}_{P_F(\xi_j)} - \underline{\nu}_{P_G(\xi_j)}| - |\overline{\nu}_{P_F(\xi_j)} - \overline{\nu}_{P_G(\xi_j)}| \\
 & |\underline{\pi}_{P_F(\xi_j)} - \underline{\pi}_{P_G(\xi_j)}| - |\overline{\pi}_{P_F(\xi_j)} - \overline{\pi}_{P_G(\xi_j)}|) = 0
 \end{aligned}$$

$$\begin{aligned}
 \Leftrightarrow & \underline{\mu}_{P_F(\xi_j)} = \underline{\mu}_{P_G(\xi_j)}, \overline{\mu}_{P_F(\xi_j)} = \overline{\mu}_{P_G(\xi_j)} \\
 & \underline{\eta}_{P_F(\xi_j)} = \underline{\eta}_{P_G(\xi_j)}, \overline{\eta}_{P_F(\xi_j)} = \overline{\eta}_{P_G(\xi_j)} \\
 & \underline{\nu}_{P_F(\xi_j)} = \underline{\nu}_{P_G(\xi_j)}, \overline{\nu}_{P_F(\xi_j)} = \overline{\nu}_{P_G(\xi_j)} \\
 & \underline{\pi}_{P_F(\xi_j)} = \underline{\pi}_{P_G(\xi_j)}, \overline{\pi}_{P_F(\xi_j)} = \overline{\pi}_{P_G(\xi_j)}
 \end{aligned}$$

$$\Leftrightarrow (P_F, A) = (P_G, B).$$

(iii) Clearly,  $PH_d((P_F, A), (P_G, B)) = PH_d((P_G, B), (P_F, A))$ .

(iv) Let  $(P_F, A), (P_G, B)$  and  $(P_H, C)$  be three *IVPFSS* ( $U$ ) over  $U$ . Then for all  $m \in \{1, 2, \dots, i\}, n \in \{1, 2, \dots, j\}$ ,

$$\begin{aligned}
 \Leftrightarrow & \max(|\underline{\mu}_{P_F(\xi_j)} - \underline{\mu}_{P_G(\xi_j)}| - |\overline{\mu}_{P_F(\xi_j)} - \overline{\mu}_{P_G(\xi_j)}| \\
 & |\underline{\eta}_{P_F(\xi_j)} - \underline{\eta}_{P_G(\xi_j)}| - |\overline{\eta}_{P_F(\xi_j)} - \overline{\eta}_{P_G(\xi_j)}| \\
 & |\underline{\nu}_{P_F(\xi_j)} - \underline{\nu}_{P_G(\xi_j)}| - |\overline{\nu}_{P_F(\xi_j)} - \overline{\nu}_{P_G(\xi_j)}|
 \end{aligned}$$





$$\begin{aligned}
 & |\underline{\pi}_{P_F(\xi_j)}(\xi_j) - \underline{\pi}_{P_G(\xi_j)}(\xi_j)| - |\overline{\pi}_{P_F(\xi_j)}(\xi_j) - \overline{\pi}_{P_G(\xi_j)}(\xi_j)| \\
 = & \max(|\underline{\mu}_{P_F(\xi_j)}(\xi_j) - \underline{\mu}_{P_H(\xi_j)}(\xi_j)| - |\underline{\mu}_{P_H(\xi_j)}(\xi_j) - \underline{\mu}_{P_G(\xi_j)}(\xi_j)|, \\
 & |\underline{\mu}_{P_F(\xi_j)}(\xi_j) - \underline{\mu}_{P_H(\xi_j)}(\xi_j)| - |\underline{\mu}_{P_H(\xi_j)}(\xi_j) - \underline{\mu}_{P_G(\xi_j)}(\xi_j)|, \\
 & |\underline{\eta}_{P_F(\xi_j)}(\xi_j) - \underline{\eta}_{P_H(\xi_j)}(\xi_j)| - |\underline{\eta}_{P_H(\xi_j)}(\xi_j) - \underline{\eta}_{P_G(\xi_j)}(\xi_j)|, \\
 & |\underline{\eta}_{P_F(\xi_j)}(\xi_j) - \underline{\eta}_{P_H(\xi_j)}(\xi_j)| - |\underline{\eta}_{P_H(\xi_j)}(\xi_j) - \underline{\eta}_{P_G(\xi_j)}(\xi_j)|, \\
 & |\underline{\nu}_{P_F(\xi_j)}(\xi_j) - \underline{\nu}_{P_H(\xi_j)}(\xi_j)| - |\underline{\nu}_{P_H(\xi_j)}(\xi_j) - \underline{\nu}_{P_G(\xi_j)}(\xi_j)|, \\
 & |\underline{\nu}_{P_F(\xi_j)}(\xi_j) - \underline{\nu}_{P_H(\xi_j)}(\xi_j)| - |\underline{\nu}_{P_H(\xi_j)}(\xi_j) - \underline{\nu}_{P_G(\xi_j)}(\xi_j)|, \\
 & |\underline{\pi}_{P_F(\xi_j)}(\xi_j) - \underline{\pi}_{P_H(\xi_j)}(\xi_j)| - |\underline{\pi}_{P_H(\xi_j)}(\xi_j) - \underline{\pi}_{P_G(\xi_j)}(\xi_j)|, \\
 & |\overline{\pi}_{P_F(\xi_j)}(\xi_j) - \overline{\pi}_{P_H(\xi_j)}(\xi_j)| - |\overline{\pi}_{P_H(\xi_j)}(\xi_j) - \overline{\pi}_{P_G(\xi_j)}(\xi_j)|, \\
 \leq & \max(|\underline{\mu}_{P_F(\xi_j)}(\xi_j) - \underline{\mu}_{P_H(\xi_j)}(\xi_j)| - |\underline{\mu}_{P_F(\xi_j)}(\xi_j) - \underline{\mu}_{P_H(\xi_j)}(\xi_j)|, \\
 & |\underline{\eta}_{P_F(\xi_j)}(\xi_j) - \underline{\eta}_{P_H(\xi_j)}(\xi_j)| - |\underline{\eta}_{P_F(\xi_j)}(\xi_j) - \underline{\eta}_{P_H(\xi_j)}(\xi_j)|, \\
 & |\underline{\nu}_{P_F(\xi_j)}(\xi_j) - \underline{\nu}_{P_H(\xi_j)}(\xi_j)| - |\underline{\nu}_{P_F(\xi_j)}(\xi_j) - \underline{\nu}_{P_H(\xi_j)}(\xi_j)|, \\
 & |\underline{\pi}_{P_F(\xi_j)}(\xi_j) - \underline{\pi}_{P_H(\xi_j)}(\xi_j)| - |\overline{\pi}_{P_F(\xi_j)}(\xi_j) - \overline{\pi}_{P_H(\xi_j)}(\xi_j)| + \\
 \max & (|\underline{\mu}_{P_H(\xi_j)}(\xi_j) - \underline{\mu}_{P_G(\xi_j)}(\xi_j)| - |\underline{\mu}_{P_H(\xi_j)}(\xi_j) - \underline{\mu}_{P_G(\xi_j)}(\xi_j)|, \\
 & |\underline{\eta}_{P_H(\xi_j)}(\xi_j) - \underline{\eta}_{P_G(\xi_j)}(\xi_j)| - |\underline{\eta}_{P_H(\xi_j)}(\xi_j) - \underline{\eta}_{P_G(\xi_j)}(\xi_j)|, \\
 & |\underline{\nu}_{P_H(\xi_j)}(\xi_j) - \underline{\nu}_{P_G(\xi_j)}(\xi_j)| - |\underline{\nu}_{P_H(\xi_j)}(\xi_j) - \underline{\nu}_{P_G(\xi_j)}(\xi_j)|, \\
 & |\underline{\pi}_{P_H(\xi_j)}(\xi_j) - \underline{\pi}_{P_G(\xi_j)}(\xi_j)| - |\overline{\pi}_{P_H(\xi_j)}(\xi_j) - \overline{\pi}_{P_G(\xi_j)}(\xi_j)|) \\
 = & PH_d((P_F, A), (P_H, C) + (P_H, C), (P_G, B))
 \end{aligned}$$

$$PH_d((P_F, A), (P_G, B)) \leq PH_d((P_F, A), (P_H, C) + (P_H, C), (P_G, B)).$$

Thus  $PH_d$  satisfies the triangle inequality.

Hence  $PH_d$  is a metric.

**PROCEDURE**

**Step 1.** IVPFSS  $(P_F, E)$  over  $U$  based on experts evaluation is constructed.

**Step 2.** IVPFSS  $(P_G, E)$  over  $U$  based on available data is constructed.

**Step 3.** Hausdorff distances  $(P_F, E)$  and  $(P_G, E)$  are computed using Definition 1.1.

**Step 4.** Similarity measure between  $(P_F, E)$  and  $(P_G, E)$  is found using Definition 1.2.

**Step 5.** The similarity measure with less Hausdorff distance between  $(P_F, E)$  and  $(P_G, E)$  is the best choice.





**Anita Shanthi and Gayathri**

**Example 2.1.** Three coffee maker companies  $(P_{G_1}, E), (P_{G_2}, E)$  and  $(P_{G_3}, E)$  with parameters

$E = \{e_1, e_2, e_3, e_4, e_5\}$  where  $e_1 =$  convenience,  $e_2 =$  timing,  $e_3 =$  price,  $e_4 =$  size and  $e_5 =$  bottom line, are rated by four customers  $C_1, C_2, C_3$  and  $C_4$  based on the above parameters. Subject to the grading of the customers the best coffee maker is to be chosen with respect to the above parameters.

**Step 1.** IVPFSS based on experts evaluation is given in Table 1.

**Step 2.** IVPFSS  $(P_{G_1}, E)$  data for coffee maker-1 is given in Table 2.

**Step 3.** The values of Hausdorff distances are

$$PH_d((P_F, E), (P_{G_1}, E)) = 0.095417,$$

$$PH_d((P_F, E), (P_{G_2}, E)) = 0.096583,$$

$$PH_d((P_F, E), (P_{G_3}, E)) = 0.096417.$$

**Step 4.** The values of similarity measures are

$$PS_m((P_F, E), (P_{G_1}, E)) = 0.912894,$$

$$PS_m((P_F, E), (P_{G_2}, E)) = 0.911924,$$

$$PS_m((P_F, E), (P_{G_3}, E)) = 0.912062.$$

**Step 5.** It is observed that  $PS_m((P_F, E), (P_{G_2}, E))$  is the least distance. Hence coffee maker-2 is the best.

## REFERENCES

1. S. Anita Shanthi and J. Vadivel Naidu, A decision making method based on similarity measure of interval valued intuitionistic fuzzy soft set of root type, *Journal of Fuzzy Mathematics*. 23 (2) (2015), pp.443-457.
2. S. Anita Shanthi and J. Vadivel Naidu, Similarity measure on interval valued intuitionistic fuzzy soft set of root type in decision making, *Journal of Soft Computing and Decision Support Systems*. 2 (4) (2015), pp. 42-47.
3. K. Atanassov, Intuitionistic fuzzy sets, *Fuzzy Sets and Systems*, 20 (1) (1986), pp. 87-96.
4. K. Atanassov, More on intuitionistic fuzzy sets, *Fuzzy Sets and Systems*, 33 (1989), pp. 37-45.
5. K. Atanassov, Some operators on intuitionistic fuzzy sets, *Notes on intuitionistic fuzzy sets*.3 (4) (1997), pp. 28-33.
6. B.C. Cuong, V. Kreinovich, Picture Fuzzy Sets - a new concept for computational intelligence problems, *Proceedings of the Third World Congress on Information and Communication Technologies WIICT*. (2013), pp. 1-6.
7. B.C. Cuong, Picture Fuzzy sets, *J. Comput. Sci. Cybern.* 30 (2014), pp. 409- 420.
8. N.V. Dinh and N.X. Thao, Some measures of picture fuzzy sets and their application in multi-attribute decision making, *Sciences and Computing*. 3 (2018), pp. 23-41.
9. M. Dugenci, A new distance measure for interval valued intuitionistic fuzzy sets and its application to group decision making problems with incomplete weights, *Applied Soft Computing*. 41 (2016), pp. 120-134.
10. D. Ke, Y. Song and W. Quan, New distance measure for Atanassov's intuitionistic fuzzy sets and its application decision making, *Symmetry*. 10 (10) (2018), pp. 1-20.
11. M.J. Khan and P. Kumam, Distance and similarity measures of generalized intuitionistic fuzzy soft set and its application in decision support system, *International Conference on Intelligent and Fuzzy Systems*. 1197 (2020), pp. 355-362.
12. Z. Liang and P. Shi, Similarity measures on intuitionistic fuzzy sets, *Pattern Recognition Letters*. 24 (15) (2003), pp.2687-2693.
13. Y. Liu and W. Jiang, A new distance measure of interval valued intuitionistic fuzzy sets and its application in decision making, *Soft Computing*. 24 (2020), pp.6987-7003.
14. M. Luo, Y. Zhang and L. Fu, A new similarity measure for picture fuzzy sets and application to multi-attribute decision making, *Informatica*. 32 (3) (2021), pp.543-564.





**Anita Shanthy and Gayathri**

15. P. Muthukumar and G.S.S. Krishnan, A similarity measure of intuitionistic fuzzy soft sets and its application in medical diagnosis, *Applied Soft Computing*, 41 (2016), pp. 148-156.
16. H. Nguyen, A new knoweldge-based measure for intuitionistic fuzzy sets and its application in multiple attribute decision making, *Experts Systems with Applications*. 42 (22) (2015), pp. 8766-8774.
17. L.H. Son, Generalized picture distance measure and applications to picture fuzzy clustering, *Soft Computing*. 46 (C) (2016), pp. 284-295.
18. E. Szmidi and J. Kacprzyk, A similarity measure for intuitionistic fuzzy sets and its application in supporting medical diagnostic reasoning, *International Conference on Artificial Intelligence and Soft Computing*. (2004), pp. 388-393.
19. N.X. Thao, Similarity measures of picture fuzzy sets based on entropy and their application in MCDM, *Pattern Analysis and Applications*. 23 (2020), pp. 1203-1213.
20. G. Wei, Some similarity measure for picture fuzzy sets and their applications, *Iranian Journal of Fuzzy Systems*, 15 (1) (2018), pp. 77-89.
21. L.A. Zadeh, Fuzzy sets, *Information and control*, 8 (1965), pp. 338-353.
22. R. Zhao, M. Luo and S. Li, A dynamic distance measure of picture fuzzy sets and its applications, *Symmetry*. 13 (2021), pp. 1-17

**Table 1. IVPFSS based on experts evaluation**

$U$	$C_1$	$C_2$
$e_1$	[00.19,00.31],[00.43,00.50],[00.06,00.12]	[00.07,00.21],[00.26,00.30],[00.16,00.24]
$e_2$	[00.13,00.24],[00.33,00.41],[00.23,00.30]	[00.15,00.28],[00.10,00.25],[00.20,00.32]
$e_3$	[00.28,00.39],[00.21,00.37],[00.18,00.26]	[00.27,00.41],[00.18,00.34],[00.06,00.22]
$e_4$	[00.09,00.16],[00.28,00.35],[00.20,00.32]	[00.05,00.14],[00.23,00.43],[00.11,00.36]
$e_5$	[00.04,00.22],[00.30,00.42],[00.14,00.34]	[00.12,00.27],[00.19,00.48],[00.04,00.17]
$U$	$C_3$	$C_4$
$e_1$	[00.16,00.23],[00.05,00.34],[00.27,00.38]	[00.10,00.22],[00.27,00.30],[00.08,00.41]
$e_2$	[00.04,00.12],[00.25,00.47],[00.10,00.22]	[00.16,00.43],[00.04,00.25],[00.11,00.19]
$e_3$	[00.18,00.30],[00.15,00.20],[00.32,00.40]	[00.20,00.32],[00.13,00.28],[00.05,00.37]
$e_4$	[00.06,00.21],[00.17,00.42],[00.26,00.35]	[00.07,00.18],[00.24,00.31],[00.23,00.40]
$e_5$	[00.24,00.33],[00.09,00.14],[00.28,00.45]	[00.12,00.21],[00.03,00.42],[00.14,00.33]

**Table 2. IVPFSS ( $P_{G_1}, E$ ) data for coffee maker-1**

$U$	$C_1$	$C_2$
$e_1$	[00.04,00.25],[00.12,00.33],[00.21,00.40]	[00.22,00.34],[00.08,00.27],[00.15,00.31]
$e_2$	[00.17,00.21],[00.09,00.28],[00.32,00.47]	[00.10,00.26],[00.19,00.33],[00.06,00.24]
$e_3$	[00.36,00.42],[00.16,00.26],[00.05,00.30]	[00.09,00.21],[00.37,00.42],[00.11,00.30]
$e_4$	[00.14,00.22],[00.27,00.36],[00.18,00.41]	[00.13,00.32],[00.25,00.51],[00.03,00.14]
$e_5$	[00.07,00.35],[00.15,00.20],[00.08,00.44]	[00.07,00.23],[00.12,00.39],[00.28,00.35]
$U$	$C_3$	$C_4$
$e_1$	[00.07,00.20],[00.13,00.38],[00.22,00.41]	[00.15,00.31],[00.24,00.47],[00.06,00.18]





**Anita Shanthi and Gayathri**

$e_2$	[00.16,00.31],[00.06,00.25],[00.32,00.43]	[00.23,00.34],[00.10,00.21],[00.37,00.40]
$e_3$	[00.23,00.37],[00.18,00.47],[00.04,00.15]	[00.07,00.14],[00.26,00.50],[00.19,00.33]
$e_4$	[00.05,00.28],[00.30,00.41],[00.27,00.34]	[00.35,00.43],[00.17,00.38],[00.04,00.16]
$e_5$	[00.14,00.40],[00.03,00.17],[00.21,00.42]	[00.13,00.28],[00.08,00.25],[00.22,00.30]

**Table 3. IVPFSS ( $P_{G_2}, E$ ) data for coffee maker-2**

$U$	$C_1$	$C_2$
$e_1$	[00.10,00.35],[00.21,00.43],[00.03,00.16]	[00.26,00.37],[00.08,00.24],[00.15,00.32]
$e_2$	[00.24,00.32],[00.07,00.15],[00.19,00.37]	[00.11,00.34],[00.30,00.42],[00.06,00.20]
$e_3$	[00.06,00.40],[00.26,00.33],[00.11,00.25]	[00.07,00.16],[00.25,00.33],[00.45,00.50]
$e_4$	[00.17,00.31],[00.42,00.50],[00.05,00.13]	[00.23,00.40],[00.09,00.21],[00.13,00.35]
$e_5$	[00.09,00.20],[00.12,00.45],[00.27,00.30]	[00.18,00.29],[00.31,00.44],[00.05,00.19]
$U$	$C_3$	$C_4$
$e_1$	[00.21,00.34],[00.15,00.26],[00.07,00.31]	[00.06,00.21],[00.26,00.36],[00.11,00.40]
$e_2$	[00.16,00.28],[00.33,00.41],[00.18,00.25]	[00.14,00.30],[00.08,00.23],[00.25,00.34]
$e_3$	[00.08,00.35],[00.20,00.48],[00.05,00.13]	[00.22,00.35],[00.17,00.44],[00.09,00.18]
$e_4$	[00.12,00.44],[00.06,00.17],[00.24,00.32]	[00.10,00.28],[00.31,00.49],[00.12,00.20]
$e_5$	[00.23,00.30],[00.11,00.25],[00.04,00.41]	[00.07,00.16],[00.42,00.54],[00.03,00.27]

**Table 4. IVPFSS ( $P_{G_3}, E$ ) data for coffee maker-3**

$U$	$C_1$	$C_2$
$e_1$	[00.09,00.27],[00.14,00.30],[00.21,00.42]	[00.16,00.23],[00.34,00.41],[00.06,00.25]
$e_2$	[00.12,00.20],[00.05,00.46],[00.15,00.24]	[00.08,00.19],[00.27,00.38],[00.13,00.20]
$e_3$	[00.25,00.33],[00.17,00.26],[00.07,00.35]	[00.24,00.30],[00.12,00.43],[00.04,00.17]
$e_4$	[00.08,00.29],[00.31,00.40],[00.11,00.22]	[00.15,00.22],[00.05,00.35],[00.21,00.40]
$e_5$	[00.14,00.23],[00.04,00.18],[00.36,00.47]	[00.07,00.18],[00.29,00.37],[00.15,00.44]
$U$	$C_3$	$C_4$
$e_1$	[00.18,00.22],[00.31,00.40],[00.08,00.35]	[00.13,00.24],[00.07,00.21],[00.37,00.42]
$e_2$	[00.05,00.11],[00.20,00.38],[00.13,00.20]	[00.18,00.32],[00.15,00.27],[00.23,00.35]
$e_3$	[00.27,00.34],[00.04,00.17],[00.24,00.42]	[00.07,00.11],[00.29,00.48],[00.14,00.30]
$e_4$	[00.14,00.37],[00.23,00.30],[00.06,00.19]	[00.25,00.40],[00.08,00.26],[00.20,00.33]
$e_5$	[00.03,00.48],[00.16,00.28],[00.12,00.25]	[00.17,00.28],[00.48,00.52],[00.03,00.16]





## Effective Microorganisms Improve Growth and Minerals Content in the Medicinal Plant *Bulbine frutescens*

Domenico Prisa\*

CREA Research Centre for Vegetable and Ornamental Crops, Council for Agricultural Research and Economics, Via dei Fiori 8, 51012 Pescia, PT, Italy.

Received: 03 Dec 2021

Revised: 23 Dec 2021

Accepted: 13 Jan 2022

### \*Address for Correspondence

#### Domenico Prisa

CREA Research Centre for Vegetable and Ornamental Crops,  
Council for Agricultural Research and Economics,  
Via dei Fiori 8, 51012 Pescia, PT, Italy.  
Email: domenico.prisa@crea.gov.it



This is an Open Access Journal / article distributed under the terms of the **Creative Commons Attribution License** (CC BY-NC-ND 3.0) which permits unrestricted use, distribution, and reproduction in any medium, provided the original work is properly cited. All rights reserved.

### ABSTRACT

The aim of this work was to evaluate if the use of Effective microorganisms on succulent plants such as *Bulbine frutescens* can improve plant growth, germination of seeds and increase mineral content of vegetative tissues. The experiments, started in January 2021, were conducted in the greenhouses of CREA-OF in Pescia (Pt) on *Bulbine frutescens*. The plants were placed in ø 12 cm pots; 30 plants per thesis, divided into 3 replicas of 10 plants each. The experimental groups were: i) group control, irrigated with water and substrate previously fertilized; ii) group with Effective microorganisms (EM) irrigated with water and substrate previously fertilized. The experiment at the greenhouse of CREA-OF in Pescia showed a significant improvement of agronomic parameters and physical, chemical and microbiological characteristics analyzed on *Bulbine frutescens* plants treated with microbial biostimulants, in particular Effective microorganisms (EM). In the trial, there was a significant improvement in the leaves number per plant, new shoots, inflorescences number, fresh vegetative weight, root weight and inflorescence weight. In addition, the use of EM resulted in a lowering of the growing medium pH, a significant increase in the microbial colonization of the treated medium, an increase in the number of germinated seeds, and a reduction in the average germination time. Chemically, there was a significant increase in nitrogen, phosphorus and potassium content in the plant tissues of *Bulbine frutescens*. Knowledge of the raw materials that make up biofertilizers is essential to understanding the actual functionality based on the plants you want to grow. The study and understanding of the application of Effective microorganisms can play an important role when it comes to productivity, sustainability, quality, growth and defense of plants from biotic and abiotic stresses.

**Keywords:** Sustainable agriculture; Beneficial microorganisms; Medicinal plants; Rhizosphere; Biodiversity.







**Domenico Prisa**

## INTRODUCTION

### Bulbine plants

Bulbine species are geophytes (plants that have an underground storage organ known as a corm), aloe-like perennial succulent plants with rosettes of fleshy leaves. The genus *Bulbine* includes about 78 species, with a variable distribution, between southern Africa and Australia. *Bulbine frutescens*, present in South Africa (in the provinces of Free State, Northern Cape, Eastern Cape, Western Cape and KwaZulu-Natal) has yellow, sometimes orange, star-shaped flowers[1-2].

From *Bulbine* tissues are obtained medicinal preparations used by peoples such as Xhosa and Zulu of southern Africa. The name of the genus *Bulbine* comes from the Greek word *bolbine* or *bolbos*, meaning "bulb" or "onion". In Latin, *Bulbine* means "small onion" or "bulb." The genus *Bulbine* was named by the German botanist Nathanael Matthäus von Wolf (1724-1784) in his 1776 publication *Genera plantarum vocabulis characteristicis*[3-4]. The Xhosa people used *Bulbine* roots to prepare decoctions and treat convulsions in children while the Zulu people administered an infusion of *B. frutescens* root and leaves as an emetic "to patients thought to be going mad as a result of witchcraft." Gel from the fresh leaves of *B. frutescens* and *B. asphodeloides* is applied topically to treat wounds, cuts, abrasions, burns, sores, rashes, itching, chapped lips, mosquito bites, ringworm and herpes[5-6]. In 2004, a monograph for *B. frutescens* was prepared through the Pharmacopoeia Monograph Project of the South African Traditional Medicines Research Group at the University of the Western Cape's School of Pharmacy with support from the South African Medical Research Council [7]. In 2010, a monograph for this species appeared in the first edition of the African Herbal Pharmacopoeia. In the European Union (EU), *B. frutescens* leaf juice is authorized for use as a skin-conditioning component of cosmetic products. Investigation of the composition of *Bulbine* species started in the 1990s, when van Staden and Drewes (1994) [8] isolated the anthraquinone knipholone from *B. latifolia* and *B. frutescens*. It took almost 10 years until these findings were affirmed and other phenylanthraquinones (4'-O-demethylknipholone-4'-O-β-D-glucopyranoside and gaboroquinones A and B) were isolated from *B. frutescens*. Widgerow *et al.* (2000) [9] predicted hydration and antibacterial properties for an extract of *B. frutescens* in scar management. Mocktar (2000) [10] confirmed antimicrobial activities of methanolic extracts of *B. frutescens*, *B. narcissifolia*, and *B. abyssinica* in a battery of tests against *Klebsiella pneumoniae*, *Staphylococcus aureus*, *Salmonella typhi*, and *Shigella flexneri* and demonstrated that a *B. frutescens* root extract inhibited *Candida albicans*. In an experimental setting, Pather *et al.* (2011 and 2012) [11-12] demonstrated a wound-healing effect of *B. natalensis* and *B. frutescens* leaf gels (specifically, an increase in tensile strength by increasing fibroplasia, collagen deposition, and maturation). Other effects investigated include antidiabetic, androgenic, antiproliferative and anti-HIV. An aqueous extract of *B. frutescens* whole plant was shown to increase glucose utilization significantly more than insulin in C<sub>2</sub>C<sub>12</sub> cells, and to promote glucose uptake in Chang liver cells (HeLa).

### Effective Microorganisms in sustainable agriculture

Effective micro-organisms are a commercial microbial selection containing a mixture of coexisting beneficial microorganisms collected from the natural environment [13]. This selection was developed at the University of Ryukyus, Japan, in early 1980 by Prof. Teruo Higa [14]. About 80 different microorganisms are able to positively influence the decomposing organic substance in such a way as to transform it into a process of "promoting life". The main species involved in EM include [15-16-17]:

- Lactic acid bacteria – *Lactobacillus plantarum*, *L. casei*, *Streptococcus lactis*;
- Photosynthetic bacteria – *Rhodospseudomonas palustris*, *Rhodobacter spaeroides*;
- Yeast – *Saccharomyces cerevisiae*, *Candida utilis*;
- Actinomycetes – *Streptomyces albus*, *S. griseus*;
- Fermenting fungi – *Aspergillus oryzae*, *Mucor hiemalis*.



**Domenico Prisa**

EM is a fermented mixed culture of naturally occurring species of micro-organisms coexisting in an acid environment (pH less than 3, 5)[18-19]. Microorganisms in EM improve crop health and yield by increasing photosynthesis, producing bioactive substances such as hormones and enzymes, accelerating the decomposition of organic materials and controlling soil diseases[20-21-22]. Effective micro-organisms can be used as herbal insecticides to control insects and pathogenic microorganisms and can also be used as plant growth inducers. Soil micro-organisms have an important influence on soil fertility and plant health. EMs interact with the soil-plant ecosystem by controlling plant pathogens and disease agents, solubilising minerals, increasing plant energy availability, stimulating the photosynthetic system, maintaining the microbiological balance of the soil, fixing biological nitrogen. A characteristic of this mixture is the coexistence of aerobic and anaerobic micro-organisms. After Higa's research in Japan, the characteristics of EM have been studied in many countries. Studies have shown positive effects of the application of EM on soils and plants on soil quality and nutrient supply, plant growth, crop yield and crop quality. However, in some studies no positive effects were found.

The aim of this work was to evaluate if the use of Effective microorganisms on succulent plants such as *Bulbine frutescens* can improve plant growth, germination of seeds and increase mineral content of vegetative tissues (Fig. 1).

**MATERIAL AND METHODS****Greenhouse experiment and growing conditions**

The experiments, started in January 2021, were conducted in the greenhouses of CREA-OF in Pescia (Pt), Tuscany, Italy (43°54'N 10°41'E) on *Bulbine frutescens*. The plants were placed in ø 12 cm pots; 30 plants per thesis, divided into 3 replicas of 10 plants each. All plants were fertilized with a controlled release fertilizer (2 kg m<sup>3</sup> Osmocote Pro®, 9-12 months with 190 g/kg N, 39 g/kg P, 83 g/kg K) mixed with the growing medium before transplanting. The experimental groups were:

- Group control (CTRL) (peat 50% + pumice 50%), irrigated with water and substrate previously fertilized;
- Group with Effective microorganisms (EM) (peat 50% + pumice 50%) irrigated with water and substrate previously fertilized, dilution 1:100 (1L of EM inoculum dilution 1:100 was used for each 10L of peat), treatment every 20 days;

The plants were watered 2 times a week and grown for 10 months. The plants were irrigated with drip irrigation. The irrigation was activated by a timer whose program was adjusted weekly according to climatic conditions and the fraction of leaching. On November 12, 2021, leaves number per plant, plantlets number per plant, inflorescences number, soil pH, fresh vegetative weight, fresh roots weight, fresh inflorescences weight, soil microbial count, seed germination, average germination time, N,P,K of plant tissues (Kjeldal UDK 169; Jenway 630501 6300 visible spectrophotometer) were analyzed.

**Statistics**

The experiment was carried out in a randomized complete block design. Collected data were analysed by one-way ANOVA, using GLM univariate procedure, to assess significant ( $P \leq 0.05$ , 0.01 and 0.001) differences among treatments. Mean values were then separated by LSD multiple-range test ( $P = 0.05$ ). Statistics and graphics were supported by the programs Costat (version 6.451) and Excel (Office 2010).

**RESULTS**

The experiment at the greenhouse of CREA-OF in Pescia showed a significant improvement of agronomic parameters and physical, chemical and microbiological characteristics analyzed on *Bulbine frutescens* plants treated with microbial biostimulants, in particular Effective microorganisms (EM).



**Domenico Prisa**

In the trial, there was a significant improvement in the leaves number per plant, new shoots, inflorescences number, fresh vegetative weight, root weight and inflorescence weight. In addition, the use of EM resulted in a lowering of the growing medium pH, a significant increase in the microbial colonization of the treated medium, an increase in the number of germinated seeds, and a reduction in the average germination time. Chemically, there was a significant increase in nitrogen, phosphorus and potassium content in the plant tissues of *Bulbine frutescens*. In (Table 1), in *Bulbine frutescens* there was a significant increase in the leaves number per plant in (EM) 20.40 compared to 13.00 in (CTRL).

There was also a significant increase in the shoot number per plant, 2.42 (EM) compared to 1.46 (CTRL) and the inflorescences number 5.83 (EM) compared to 4.44 in the untreated control. In terms of vegetative weight, the thesis (EM) was the best with 93.32 g in comparison to the control (CTRL) with 88.52 g (Figure 2). The same trend for root weight where (EM) showed a weight of 72.53 compared to (CTRL) with 66.37 g and in terms of inflorescence weight (EM) with 5.96 g and (CTRL) with 4.64 g (Figure 3). The substrate treated with Effective microorganisms showed a reduction in pH 6.3, unlike the control where the pH was higher 7.2 (Table 2). Also in the substrate (EM) there was a significant increase in the microorganisms number  $1.1 \times 10^3$  cfu/g in contrast to the control where colonization was lower  $2.6 \times 10^2$  cfu/g. There was also an increase in germinated seeds 80.21 (EM) compared to 59.64 (CTRL) and a reduction in mean germination time 22.60 days (EM) in comparison to 26.00 days in the control. The trial also showed that the use of a microbial biostimulant based on Effective microorganisms can significantly increase in the vegetative tissue of plants the nitrogen content 3.52 mg/Kg (EM) and 2.70 mg/Kg (CTRL), phosphorus 17.80 mg/Kg in (EM) compared to 15.74 mg/Kg (CTRL) and potassium 46.14 mg/Kg in (EM) compared to 43.08 mg/Kg of the untreated control.

**DISCUSSION**

Microbial inoculants are generally products that contain microorganisms, usually selected from plant roots and root zones. Field and above-ground experiments show that application of these products can increase plant growth by up to 40% as a result of rhizosphere and root colonization, promoting seed germination, plant development, and increased aesthetic quality of leaves and flowers. It is clear that the use of microbial consortia can improve soil fertility and crop production, ensuring greater solubility of nutrients, increasing their availability to the roots, increasing the resistance of plants to biotic and abiotic stresses[23]. The microorganisms of the rhizosphere participate in the mechanism of biocontrol, occupying sites of infection, sequestering nutrients to pathogenic microorganisms, inducing and stimulating the plant to produce useful metabolites for defense[24].

The application of plant growth-promoting rhizobacteria (PGPR), for example, can improve vegetative and root development, increase flower and fruit production, promote an increase in the intensity of leaf and flower colors, stimulate seed germination, and result in a reduction in average germination time, with the possibility of accelerating the growing cycle of plants [25] (Lavelle, 1988). Another very interesting aspect in the application of symbiotic microorganisms is the possibility of being able to reduce their use over the years, thanks to their ability to colonize surfaces and multiply autonomously. Some microorganisms commonly used as biofertilizers can fix atmospheric nitrogen and solubilize phosphate[26]. Many phytohormones are the result of bacterial stimulation on plants. Another very interesting aspect in the application of symbiotic microorganisms is the possibility of being able to reduce their use over the years, thanks to their ability to colonize surfaces and multiply autonomously. Some microorganisms commonly used as biofertilizers can fix atmospheric nitrogen and solubilize phosphate[27]. Many phytohormones are the result of bacterial stimulation on plants, which, in addition to improving response to pathogens, can increase the production of industrially and pharmaceutically useful metabolites. In recent years, metagenomics approaches have been widely applied to characterize the diversity and structure of microbial communities in order to evaluate and select possible microorganisms that can improve plant growth[28]. In this trial, it was evident how the use of microorganisms colonizing the rhizosphere, in particular





### Domenico Prisa

Effective microorganisms (EM), resulted in a significant improvement in the germination, growth, and floral productivity of *Bulbine frutescens* plants. In addition, an increase in the number of microbial colonies present in the substrate and in the mineral content present in the vegetative tissues of the plants was found. Aspects and results found in other types of plants, but that on medicinal plants may have a further and important interest [29-30]. Biofertilizers are an alternative to chemical fertilizers, since they contain natural components that do not harm plants. They can protect crops from disease development, fungal attack and protect the plant from other diseases and free pollutants. The administration of microorganisms to soil and substrates is possible through liquid cultures, freeze-dried products, or through the administration of plant composts. For example, the addition of compost to substrates can reduce the content of peat, a material that is nowadays sought to be limited in soils, and improve the fertility of the substrate by increasing biodiversity and organic matter [31]. The beneficial effects of microorganism applications are generally enhanced by the concomitant application of organic amendments, because most of the microorganisms that comprise EMs are heterotrophic and, therefore, require organics as a carbon and energy source for their growth and metabolism. Therefore, during treatments the provision of organic amendments can ensure optimal growth of these microbial consortia and at the same time the release of useful plant nutrients.

## CONCLUSIONS

The chemical and physical properties of soils and substrates can affect the growth of microorganisms. Encouraging the development of microbial colonies can significantly enhance plant growth and is a key aspect of achieving sustainable agricultural goals in the future. Knowledge of the raw materials that make up biofertilizers is essential to understanding the actual functionality based on the plants you want to grow. The study and understanding of the application of Effective microorganisms can play an important role when it comes to productivity, sustainability, quality, growth and defense of plants from biotic and abiotic stresses. In this article it has evolved to highlight the real effectiveness of these microbial biostimulants, which in addition to being affordable and easily available, can positively affect crops in the open field and above ground, reduce the incidence of plant diseases, increase soil fertility, reduce stresses due to climate change.

## ACKNOWLEDGMENTS

The research is part of the project "MicroSuc: microorganisms for the growth and protection of cacti and succulent plants"

## REFERENCES

1. Proches, Ş., Cowling, R.M., Goldblatt, P., Manning, J.C., Snijman, D.A. (2006). An overview of the Cape geophytes. *Biol J Linn Soc.* 87(1):27-43
2. Xaba, P. (2008). *Bulbine frutescens*. *Veld&Flora.* 166- 167
3. Ghuman, S., Ncube, B., Finnie, J.F., McGaw, L.J., Coopoosamy, R.M., van Staden J. (2016). Antimicrobial activity, phenolic content, and cytotoxicity of medicinal plant extracts used for treating dermatological diseases and wound healing in KwaZuluNatal, South Africa. *Front Pharmacol.* 7(320)
4. Brendler, T., Eloff, J.N., Gurib-Fakim, A., Phillips, L.D., eds. (2010). *African Herbal Pharmacopoeia*. Port Louis, Mauritius: African Association for Medicinal Plants Standards
5. Hutchings, A., Scott, A.H., Lewis, G., Cunningham, A.B. (1996). *Zulu Medicinal Plants: An Inventory*. Pietermaritzburg, South Africa: University of Natal Press
6. Mabona, U., Van Vuuren, S.F. (2013). Southern African medicinal plants used to treat skin diseases. *S Afr J Bot.* 87:175- 193
7. Abegaz, B.M., Bezabih, M., Msuta, T. (2002). Gaboroquinones A and B and 4'-O-demethylknipholone-4'-O-β-dglucopyranoside, phenylanthraquinones from the roots of *Bulbine frutescens*. *J Nat Prod.* 65(8):1117-1121
8. Van Staden, L.F., Drewes, S.E. (1994). Knipholone from *Bulbine latifolia* and *Bulbine frutescens*. *Phytochemistry.* 35(3):685-686



**Domenico Prisa**

9. Widgerow, A.D., Chait, L.A., Stals, R., Stals, P.J. (2000). New innovations in scar management. *Aesth Plast Surg.* 24(3):227-234
10. Mocktar, C. (2000). Antimicrobial and chemical analyses of selected Bulbine species. Thesis (M.Med.Sc.). Department of Pharmacy in the Faculty of Health Sciences at the University of DurbanWestville: Westville, South Africa
11. Pather, N., Kramer, B. (2012). Bulbine natalensis and Bulbine frutescens promote cutaneous wound healing. *J Ethnopharmacol.* 144(3):523-532
12. Pather, N., Viljoen, A.M., Kramer, B. (2011). A biochemical comparison of the in vivo effects of Bulbine frutescens and Bulbine natalensis on cutaneous wound healing. *J Ethnopharmacol.* 133(2):364-370
13. Condor, A.F, Gonzalez, P., Lakre, C. (2007). Effective microorganisms: myth or reality? *The Peruvian Journal Biology* 14: 315-319
14. Formowitz, B., Elango, F., Okumoto, S., Müller, T. and Buerkert A. (2007). The role of effective microorganisms in the composting of banana (*Musa ssp.*) residues. *J. Plant Nutr. Soil Sci.* 170, 649–656
15. Prisa, D. (2019). Germination Of Vegetable And Grassland species With Micronized chabazitic-Zeolites And Endophytic Fungi. *IOSR Journal of Agriculture and Veterinary Science* 12(51): 32-37
16. Prisa, D. (2019). Improvement Quality and Content of Pepper and Chilli Nitrates Influenced by the Effective Microorganisms. *American Scientific Research Journal for Engineering, Technology, and Sciences (ASRJETS).* 53(1): 176-181
17. Prisa, D. (2019). Rhizobacteria and zeolites for overcoming saline stress in the cultivation of succulent plants. *The International Journal of Engineering and Science (IJES)*, 8(51):38-41
18. Daly, M.J., Stewart, D.P.C. (1994). Influence of "Effective Microorganisms" (EM) on Vegetable Production and Carbon Mineralization—A Preliminary Investigation, *Journal of Sustainable Agriculture* 14(2-3): 15-25.
19. Edwards, C., and Fletcher, K. (1988). Interactions between earthworms and microorganisms in organic matter break down. *Agr. Ecosyst. Environ.* 24:235-247
20. Mayer, J., Scheida, S., Widmera, F., Fließbach, A. and Oberholzer, H.R. (2010). How effective are 'Effective microorganisms® (EM)'? Results from a field study in temperate climate. *Appl. Soil Ecol.* 152-156
21. Maramba, B., Sangakkara, U.R. (1996). "Effect of EM on weed populations, weed growth and tomato production in Kyusei nature farming". <http://www.futuretechtoday.net/em/index2.htm>
22. Olle, M. (2014). Effect of Effective microorganisms on yield, quality and preservation of vegetables. In: *Gardening Forum*, 10-13
23. Xu, H.L., Wang, R., Miridha, M. (2001). "Effects of Organic Fertilizers and a Microbial Inoculant on Leaf Photosynthesis and fruit Yield and Quality of Tomato plants". *Journal of Crop production*, 3:173-182
24. Prisa, D., Sarrocco, S., Forti, M., Burchi, G., Vannacci, G. (2013). Endophytic ability of *Trichoderma* spp. as inoculants for ornamental plants innovative substrates. *IOBC Bulletin*.vol.86: 169-174
25. Lavelle, P. (1988). Earthworms activity in the soil system. *Biol. Fertil. Soil.* 6:237-251
26. Mohan, B. (2008). "Evaluation of organic growth promoters on yield of dryland vegetable crops in India". *Journal of Organic Systems*, 3:23-26
27. Tomar, V., Bhatnagar, R. and Palta, R. (1998). Effect of vermicompost on production of brinjal and carrot. *Indian Agr. Res. J.* 13:153-156
28. Willems, J., Marmissen, J. and Blair, J. (1996). Effects of earthworms on nitrogen mineralization. *Biol.Fertil. Soils* 23:57-63
29. Olle, M., Williams, I.H. (2015). "The influence of Effective Microorganisms on the growth and Nitrate content of vegetable transplants". *Journal of Advanced Agricultural Technologies*, 2(1), 25-28
30. Siquera, M.F.B., Sudrè, C.P., Almeida, L.H., Pegoreri, A.P.R., Akiba, F. (2012). "Influence of Effective Microorganisms on seed Germination and plantlet vigor of selected crops".
31. Neal, K. (1991). Examine medium alternatives. *Greenhouse Manager* 10:42-48





Domenico Prisa

Table 1 - evaluation of microbic biofertilizer on the agronomic characters of *Bulbine frutescens*

Groups	LN (n°)	PN (n°)	IN (n°)	VW (g)	RW (g)	IW (g)
CTRL	13,00 <sup>b</sup>	1,46 <sup>b</sup>	4,44 <sup>b</sup>	88,52 <sup>b</sup>	66,37 <sup>b</sup>	4,64 <sup>b</sup>
EM	20,40 <sup>a</sup>	2,42 <sup>a</sup>	5,83 <sup>a</sup>	93,32 <sup>a</sup>	72,53 <sup>a</sup>	5,96 <sup>a</sup>
ANOVA	***	*	**	**	***	**

One-way ANOVA; n.s. – non significant; \*, \*\*, \*\*\* – significant at P ≤ 0.05, 0.01 and 0.001, respectively; different letters for the same element indicate significant differences according to Tukey's (HSD) multiple-range test (P = 0.05). Legend: (CTRL): control; (EM): Effective microorganisms; (LN): leaves number; (PN): plantlets number; (IN): inflorescences number; (VW): vegetative weight; (RW): roots weight; (IW): inflorescences weight

Table 2 - Microbiological activity of the substrate and minerals content of *Bulbine frutescens*

Groups	pH	SC (cfu/g)	SG/100 seeds (n°)	TG (days)	N (mg/Kg)	P (mg/Kg)	K (mg/Kg)
CTRL	7,2	2,6 x 10 <sup>2b</sup>	59,64 <sup>b</sup>	26,00 <sup>a</sup>	2,70 <sup>b</sup>	15,74 <sup>b</sup>	43,08 <sup>b</sup>
EM	6,3	1,1 x 10 <sup>3a</sup>	80,21 <sup>a</sup>	22,60 <sup>b</sup>	3,52 <sup>a</sup>	17,80 <sup>a</sup>	46,14 <sup>a</sup>
ANOVA	-	***	***	**	**	***	**

One-way ANOVA; n.s. – non significant; \*, \*\*, \*\*\* – significant at P ≤ 0.05, 0.01 and 0.001, respectively; different letters for the same element indicate significant differences according to Tukey's (HSD) multiple-range test (P = 0.05). Legend: (CTRL): control; (EM): Effective microorganisms; (SC): substrate microbial count; (SG/100 seeds): total germination on 100 seeds; (TG): time germination; (N): nitrogen; (P): phosphorus; (K): potassium



Figure 1- Pots cultivation of *Bulbine frutescens* in the greenhouses of CREA-OF

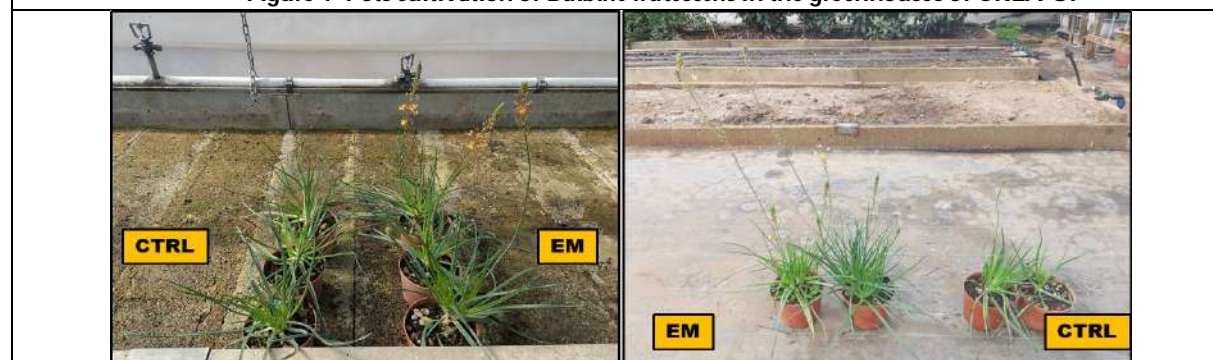


Figure 2 - Treatments comparison in the vegetative growth of *Bulbine frutescens*. Legend: (CTRL): control; (EM): Effective microorganisms





Domenico Prisa



Figure 3 - Effective microorganisms effect(EM)on roots growth of *Bulbine frutescens*





## Process Validation of Inhalation Aerosols in Pharmaceutical Industry

V. Manikandan\* and N. Srinivasan

Department of Pharmacy, Annamalai University, Chidambaram, Tamil Nadu, India

Received: 24 Nov 2021

Revised: 29 Dec 2021

Accepted: 13 Jan 2022

### \*Address for Correspondence

#### V. Manikandan

Department of Pharmacy,

Annamalai University,

Chidambaram,

Tamil Nadu, India

Email: manimpharm20@gmail.com



This is an Open Access Journal / article distributed under the terms of the **Creative Commons Attribution License** (CC BY-NC-ND 3.0) which permits unrestricted use, distribution, and reproduction in any medium, provided the original work is properly cited. All rights reserved.

### ABSTRACT

The purpose of the study was to discuss the process validation of inhalation aerosols in pharmaceuticals. Inhalation aerosol is a form of drug that administering directly to the respiratory system. A metered-dose inhaler (MDI) is a drug administered using a liquified gas propellant from a pressurized container. It is usually predictable dosage form for inhalation. These dosage forms treat therapeutic responses to respiratory problems, idiopathic pulmonary disease, and pulmonary edema manifestations. During the process validation, the discrete fabrication and testing specifications are needed for introducing the new product of MDI. The parameters should be validated on each process and step involved in the manufacturing of inhalation aerosols. The test result should be precise and accurate. In process validation studies raw materials, packaging components, the manufacturing process of concentrate filling and propellant filling, and line testing should be performed and ensured the test results will consistently meet official compendial specifications as well as supplier specifications for propellants and packaging components.

**Keywords:** Process Validation, Metered Dose Inhalers.

### INTRODUCTION

Since the mid – the 1950s, Inhalation aerosol is a form of drug that administering directly to the respiratory system. A metered-dose inhaler (MDI) is a drug administered using a liquified gas propellant from a pressurized container. It is usually predictable dosage form for inhalation. These dosage forms treat therapeutic responses to respiratory problems, idiopathic pulmonary disease, and pulmonary edema manifestations. The drug is directly administered to the respiratory system is often called a distinctive pharmaceutical dosage form. It should not classify under oral drug delivery form, in which the drug is distributed via the digestive system, or parenteral dosage form, in which the drug is distributed effectively in the extracellular fluid. Apart from that, the MDI is coming under the classification of





**Manikandan and Srinivasan**

non-sterile dosage form products. Inhalation aerosol should not contain any microbiological growth because of the nonaqueous system generally found at MDI. There is a self-propelling dosage form with aid of chlorofluorocarbons (CFCs) or hydrofluorocarbons (HFAs) that are delivered by a pressurized system. Some products of MDI are intended to administering via oral cavity. However, there are such products administering via nasal cavity and or sublingually. The determination of the type of actuator depends on the site of administration with the aerosol canister. The uses of drugs represent different classes like beta-adrenergic agents, selective adrenoreceptor (beta2) agents. These are the vasodilators for the mitigation of respiratory problems, idiopathic pulmonary disease, and pulmonary edema. In MDI, anti cholinergic agents are also available to inhibiting mast cells. The drugs are additionally used for vasodilation and antimigraine. There are two types of MDI formulation. One is the micronized MDI and another one is solution. In micronized formulation, the active ingredient is suspended in liquefied gas propellants like HFAs or CFCs. In solution formulation, the active ingredient is dissolved in ethanol and HFAs or CFCs mixtures. During the process validation, the discrete fabrication and testing specifications are needed for introducing the new product of MDI [1].

**RAW MATERIAL****Active Pharmaceutical Ingredient (API)**

Check and ensure the consequential attributes of the APIs are product degradation, impurities, water content, static charge, polymorphism, particle size, microbial content, and crystallinity according to official compendia. The parameters of micronized process or milling should be recorded and monitored. Ensure the consistency and distribution of particle size of the final product by the manufacturing process [2]. Ensure the moisture content and particle size are determined by a specific method like differential thermal analysis (DTA), X-ray diffraction. These data should be recorded and added to the validation report.

**Propellants**

MDI propellants on the market include dichlorotetrafluoroethane NF, trichloromonofluoromethane NF, and trichloromonofluoromethane NF, tetrachloromonofluoroethane, etc., ensure those propellants meets their requirements according to compendial grade specifications. Ensure the supplier for all propellants, they should be a single supplier. Check and ensure the propellants (Table. 1) molecular weight, boiling point, vapor pressure, and density which is given by supplier information. CFC or HFA propellants must meet their assay specifications for determining their purity. During shipping for manufacturing process, propellants should be shipped with drums or steel cylinders and are under pressure. Check and ensure the filter propellants are against particulate before filling. The compatible filters with CFC or HFA propellants are Nylon, Teflon, Polyvinylidene difluoride should be reported and its filter range shall be 0.22 – 0.45 micrometer [3]. Check and ensure the sampling process like prechilled cans, crimping, dipping for propellants to prevent vaporization. Ensure the condensation of moisture content of the container and propellant.

**Suspending Agents**

Check and ensure the storage conditions and stability requirements for suspending agent before shipping to manufacturing process. For example, whey protein compound is photosensitive and deteriorates when exposed to air. Some suspending agents are oleic acid and sorbitan trioleate should meet their official compendial specifications [4].

**Cosolvents**

According to alcohol USP, check and ensure the alcohol grades. The MDIs are generally nonaqueous manner. However, the proportion of water content is crucial.





## PACKAGING COMPONENTS

Check and ensure the functions of individual packaging components like a metered valve, aluminium can or plastic can, mouthpiece by the supplier. Because the consistent drug delivery occurred by functions of the valve and actuator [5]. Then check and ensure the fitting of packaging components because it can also lead to cause improper drug delivery.

### Metered Valve

Check and ensure the characteristics of metered valve test specifications are coordinated with the supplier [6]. The characteristics of the metered valves are appearance, uniqueness, appropriate connection, appropriate portion, multiple sprays ruggedness, size of meter chamber, variability of meter chamber, capability of sealing, test for in-use, sealability of meter chamber and rubber its contaminants, and cleanliness of valves. The test requirements of the metered valves are attributes inspection, check the parameters follows dimension, mean, weight of spray, relative standard deviation, actuation as per labeled content, loss of weight which means leakage, quality, particulates, and extractables respectively. Ensure the metered valve is crimped with either aluminium can or glass bottle properly. This proper crimping provides respective the amount of drug delivery during a single spray. Check and ensure the critical dimensions are associated with stem dimension for mouthpiece fitting, metering chamber size for dosage reproducibility, length of stem stroke, size of orifice for rate of pressure filling and refilling of meter chamber [7]. Check and ensure the incoming components which are correlated with schematic drawings, and tubing or other modules should be checked to ensure that the supplier's configurations or operating parameters haven't yet changed. Valves should be shipped with bags that are hermetically sealed to prevent moisture adsorption on polycarbonate or tubing modules. The above requirements are should comply with USP standards as well as supplier specifications [8].

### Aluminium Can

During validation, check the components should comply with the drawings' specifications. Its states that, date and number of drawings, serial number and batch number, dimensions of height, width, and thickness, empty weight, material type of each component. Check the aluminum anodizing, glass treatment, epoxy lining for each component. Check the components are properly cleaned or not [9]. Check the inspection of the can or bottle concerns individuality, characteristics, and dimensional checks. Check and ensure chemical tests such as resistance of acid or pH. Check and ensure the integrity of the crimp is related to neck configuration [10].

### Mouthpieces

Check and ensure the compositions of mouthpieces like oral adaptors, actuators. It should not interact with drug components. During validation, check the components should comply with the drawings' specifications. Check the dust cap is provided. Check and ensure the mouthpiece and can are properly assembled and the canister properly inserted into mouthpiece. Ensure the mouthpiece critical dimensions that are spray orifice size, mouthpiece coupling, configuration of mouthpiece, angle of spray, and valve stem should meet requirement specifications according to USP [11]. These parameters should be performed by TLC. Check and ensure the instruction to consumers generally that encompasses the mouthpiece washed by water daily. Hence, this to prevent dust particles entered to canister through mouthpiece.

### Manufacturing

During manufacturing the environmental condition should be ensure that, relative humidity 15 – 40%, temperature 20 - 25°C, and compressor air drier dew point 2 to 8°C [12].

### Concentrate Preparation

#### Suspension

To forming a suspension drug concentrate is by mixing of suspending agents, micronized drugs, and high boiling propellants during a cold-filling method. The process of mixing made by the parts of mixer prompter, turbine, or,



**Manikandan and Srinivasan**

homogenizer. Throughout the process validation, the conditions of mixing should be documented. These include details of mixers, position (angle or distances), speed, direction, and recirculation conditions. Should be used qualification report of the mixer such as design and performance qualification during operation [13]. The mixers speed ranges should be 45 to 55 rpm. The drug concentrate temperature should be monitored. It should be 55-60° F. If the preparation time is more than 1 hour, the concentrate temperature should be too high. It may lead to evaporation of propellants and this will increase the drug concentration in resulting suspension. Check and ensure the weight of volatile propellants and drug concentrate. Perform in-process assay for monitoring any loss of propellants. Assure an aggregate-free suspension of concentrate which is filtered an appropriate size filter during testing of validation and it should be documented [14].

**Solutions**

Add the drug concentrate to the mixture of ethanol and propellant. Here, ethanol as a cosolvent which contribute the drug soluble. Ensure the minimum evaporation rates should be compatible with low temperature while filling as well as use easily soluble ingredients. The temperature should be ranges from -50 to +5°C. Check and ensure the vapor pressure, it should be 35 to 60 psig at 121°C. Vapor pressure may be higher for some propellants (HFA 134a and 227, CFC 12) are 60 to 70 psig at 20°C [14].

**Filling Equipment's**

During the process of filling add the drug concentrate into the canister Approximately 1 mL to 15 mL The filling equipment contains either positive piston fillers or gravity fillers. In 'Pamasol' filling equipment, piston fillers may be used. While filling volume of drug concentrate about 2 ml may be filled by gravity filling. It is controlled by time and size of nozzle. Piston filling is more accurate and precise and it is controlled by length, size of bore and piston. Check and ensure the equipment prevent from atmospheric moisture by fabrication [14]. In process validation, flow rates of nitrogen should be monitored. It should be 4 scfh (Standard Cubic Feet per Hour).

**Propellant Filling****Cold-Fill Method**

CFC 114 and 12 mixing process is called cold-fill method. It may be added with propellant 11 if necessary. CFC 12 vapor pressure reduced by CFC 114 and it can be filled with heavy temperature without the loss of propellant. The above said mixtures are added to propellant 11 which contains drug concentrate and filled by the method of cold-filling. Ensure the temperature of cold-fill method it shall be -30 to -45° F [15].

**Pressure Fill Method**

In pressure filling method, the mixture propellant filled individually. Check and ensure the control limits for adjustment of acceptance as per BPR instruction. During validation, to verify the filling accuracy is to be performed by in-process weight check at specified time intervals. Prepare control charts for each step of filling process. Propellant filling and drug concentrate are a two-filling step process of pressure fill method. Check and ensure the final drug concentration, because the final concentration of drug will produce lowest concentration by the filling of lower and upper limits of drug concentrate. It shall be within 90 to 110% of the label claim [16]. In this process, 1% of drug concentrate provides 2.50mg/g of final can potency. Ensure that the RSD of propellant fill is less than 2.0 percent, and that the maximum and minimum limits of concentrate fill are one-fourth of 8.0 percent. For example, the concentrate fill target is 3.89 g ± 0.23 g. (5.9 percent). The RSD of propellant fill should be less than 1.5 percent, or one-fourth of the maximum of 5.9 percent.

**HFA Filling**

During HFA filling, the suspension (solution), composition contains pure drug either with additives, and dispensing agent, among other things, are all present. This suspension should be decided to add to the canister at ambient temperature, with a tank pressure of 150 psig. Check and ensure the filling tank is properly cleaned and sealed [17]. By under pressure, the propellant is added to the tank. The drug is fully dissolved or suspended in the propellant after this mixture is agitated. The propellant is then fed to a canister through the valve stem after the canister has





been thoroughly cleaned and crimped with a metered valve. The process should be monitored during validation to ensure that the finished product meets all USP specifications [18].

## LINE TESTING

### Crimping

The crimping process occurs to prevent propellant vaporization and air entrapment. Crimping will occur by ferrule of the valve is compressed under pressure. During process validation, check and ensure the crimping parameters and it should be recorded. The parameters are head pressure, collet pressure, and pad pressure. The crimping process may be needed for ensuring appearance, valve function, leakage, and propellant filling [19]. Check and ensure the collet pressure, if this pressure may increase during crimping may lead to undesirable surface and leakage. Check the crimping diameter or height for the different settings. The parameters and measurements for crimped valves are listed below.

### Crimp Height

The crimp height is measured from the top of the crimp jaw marks to the top of the ferrule. It should be related to leakage. Check and ensure the crimp height. If the height is too large, the result may lead to improper crimp and occur excessive leakage. If the height is too small, the result may lead to affect the appearance and valve function. So, the height of the crimp should be 6.5 to 7.5 mm which means, 0.26 to 0.30 in. Use caliper or another suitable device to measure the height of the crimp. The constant depth of the crimped radius is 19 mm by Socoge gauge device [20].

### Crimp Diameter

This diameter is measured from one point to another point of the crimp circumference at 360°. This value should be 17.5 to 18.5 mm after crimped valve. The uncrimped diameter should be 20 mm.

### Roll Off

Roll Off is referred as distinguish the lowest and highest of the four values at 90° apart. This measurement is measured at four locations 90° apart and calculated from the ferrule's bottom to the ferrule's top. These locations represent the valve's pressure homogeneity during compression. This value should be less than 0.01 cm (0.1 mm) [21].

### Gasket Compression

The gasket compression illustrates the sealing of the gasket. The sealing occurs between the can and ferrule of the valve. Gasket compression is measured from the thickness of the crimped unit by subtracting the thickness of uncrimped unit. The thickness of the crimped unit is measured from the height of the crimp by subtracting parts after disassembly of the filled unit. This measurement is determined by the equation of;

$$j' = H - (2 \times e) - h'$$

where, H is crimped unit of height, e is ferrule thickness, h' is can neck height and j' is yield of crimped gasket and rim thickness [22].

### Can Deflection

Check and ensure the can deflection after crimping. During crimping, the height of the can deflected from its original height. This measurement was performed by comparing the uncrimped can with crimped can. Here, constant 19 mm diameter of Socoge gauge may be used to measure the reflection of can.

### Appearance

After crimping, check at the end of the valve that should be free from sharp edges.



**Leak Testing**

Check and ensure the leak test for all aerosol cans before distribution. For leak testing there are 4 methods is there. Those methods are; Hot water bath, Induction heater, Storage, and Pressure readings. During hot water bath, the temperature may raise the product's boiling point above. The most common temperature shall be 120 - 130° F. Fit the cans into hot water bath at least 1.5 to 3 minutes. After that, the cans should be inspected visually and reported if any leakage is there. During induction heaters, the aerosol cans heated instantaneously and check the weight at a later time. Any faulty units or poorly crimped aerosol line would cause testing to be obstructed and the line to be disengaged. Typically, an ensuant check is performed, and any intact unit leakers are removed. Modules are performed for a long enough period of time for leakers to fail an ensuant check consideration step. Ferret faulty units are tested for fourteen to twenty-eight days. Before filling, use a pressure reading test to ensure the integrity of the componentry. This test shows how to check the crimp tightness [23].

**Weigh Checking**

This test is used to ensure that accuracy of filling and all aerosol cans contain an adequate amount of medication or uniformity of the final product may completed prior to secondary packaging and distribution. As well as the propellant wight also check by this method. This expressed as ounces and pounds.

**Spray Testing**

Check and ensure any defects in the valve and the spray pattern. During validation the rejection rate should be documented. The rejection should be less than 0.1% of targeted drug release. After testing, the rejection units are removed and the removed units inspected for analysing the false result where and when occurred. Also check the manufacturer quality of valve.

**Labeling**

Check and ensure the proper labeling of the product. The requirements for labeling as follow; active ingredient(s) name, dosage strength, manufacturing number, batch number, storage conditions, directions of use, precautions and expiry date when required, name and address of the manufacturing company and manufacturer who responsible for distribute the market [24].

**Finished Product and Release**

Finished product needs to be analysed as per in-house specification. Product needs to be released only after pre-determined specifications and quality attributes.

**CONCLUSION**

Process validation is the established documented evidence for the manufacturing process and critical steps involved in the process of metered-dose inhalers (MDIs) which provides a high degree of assurance that will consistently produce the product meeting its predetermined specifications and quality attributes. The validated test results should meet official compendial specifications. Hence, the process concluded that followed confirms its capability of producing the product in a consistent manner.

**REFERENCES**

1. Robert A. Nash, Alfred H. Wachter - Pharmaceutical Process Validation, An International Third Edition (Drugs and the Pharmaceutical Sciences), 329-361.
2. Kanig, J. L., Pharmaceutical aerosols. Journal of Pharmaceutical Science Vol.14, Issue 4, 52:513–553.
3. Sciarra, J. J. Pharmaceutical and cosmetic aerosols. Journal of Pharmaceutical Science Vol. 8, Issue 2, 63:1815–1837.





**Manikandan and Srinivasan**

4. Hallworth, G. W., Padfield, J. M. Comparison of the regional deposition in a model nose of a drug discharged from metered-aerosol and metered-dose nasal delivery systems. *Journal of Allergy Clinical Immunology* 77(2):348–353.
5. Physical tests and determinations: <601> aerosols. The United States Pharmacopeia (USP). vol. 25. Rockville, MD: U.S. Pharmacopeial Convention.
6. Kibbe, A. H. Handbook of Pharmaceutical Excipients. 3rd ed. Washington, DC: American Pharmaceutical Association, pp. 134, 234, 560.
7. Gorman, W. G., Popp, K. F., Hunke, W. A., Miriani, E. P. Process validation of aerosol products. *Aerosol Age* 32(3):24–28.
8. Hallworth, G. W. The formation and evaluation of pressurized metered-dose inhalers. In: I. Gandeston, I. Jones, eds. *Drug Delivery to the Respiratory Tract*. Chichester, UK: Ellis Horwood, pp. 87–118.
9. Cutie, A., Burger, J., Clawans, C., Dolinsky, D., Feinstein, W., Gupta, B., Grueneberg, A., Sciarra, J. Test for reproducibility of metered-dose aerosol valves for pharmaceutical solutions. *J Pharm Sci* 70:1085–1987.
10. Fiese, E. F., Gorman, W. G., Dolinsky, D., Harwood, R. J., Hunke, W. A., Miller, N. C., Mintzer, H., Harper, N. J. Test method for evaluation of loss of prime in metered-dose aerosols. *Journal of Pharmaceutical Science* 72:90–93.
11. Cyr, T. D., Graham, S. J. Low first-spray drug content in albuterol metered-dose inhalers. *Pharm Res* 8:658–660.
12. Benjamin, E. J., Kroeten, J. J., Shek, E. Characterization of spray patterns of inhalation aerosols using thin-layer chromatography. *Journal of Pharmaceutical Science* 72:380–385.
13. Miszuk, S., Gupta, B. M., Chen, F. C., Clawans, C., Knapp, J. Z. Video characterization of flume patterns of inhalation aerosols. *Journal of Pharmaceutical Science* 69:713–717.
14. Dhand, R., Malik, S. K., Balakrishnan, M., Verma, S. R. High speed photographic analysis of aerosols produced by metered dose inhalers. *Journal of Pharmacy and Pharmacology* 40: 429–430.
15. Cutie, A., Ertifaie, S., Sciarra, J. J. Aerosolized drug delivery accessories, *Aerosol Age* 27(4):21–30.
16. Sciarra, J. J. and Sciarra, C. J. Aerosols. In: Remington: The Science and Practice of Pharmacy. 20th ed. Baltimore: Lippincott Williams and Wilkias.
17. Bozzone, S. Validation of inhalation aerosols. In: R. R. Berry, R. A. Nash, eds. *Pharmaceutical Process Validation*. vol. 57, 2nd ed. New York: Marcel Dekker (2017).
18. Haase, F. D. Techniques of crimping and clinching: An overview. *Aerosol Age* 32(1):21-24.
19. Induction heating tests aerosols in pharmaceutical operation. *Aerosol Age* 27(1): 14–17.
20. Mintzer, H. Scale-up and production considerations for therapeutic aerosols. *Aerosol Age* 30(3):22–24.
21. Miller, N. C., Schultz, R. K., Schachtner, W. J. Through-life dose uniformity in pressurized metered dose inhalers. *Pharmaceutical Research* 7(9, suppl.): S–88.
22. Ranucci, J. A., Dixit, S., Bray, R. N., Goldman, D. Controlled flocculation in metered- dose aerosol suspensions. *Pharmaceutical Technology* 14(4):68, 70–72, 74.
23. Schultz, R. K., Miller, N. K., Christensen, J. D. Method for evaluation of suspension characteristics relevant to metered dose inhaler formulations. *Pharmaceutical Research* 7(9, suppl.): S–88.
24. U.S. Food and Drug Administration. Guideline on General Principles and Process Validation. Center for Drugs and Biologics and Center for Devices and Radiological Health, Rockville, MD. p. 4.

**Table 1: Physical properties of propellants for MDI products.**

Propellants	Molecular weight	Boiling point (°C)	Vapor pressure (psig) at 21. 1°C	Density (g/ml)
Dichlorotetrafluoroethane (P114)	170.9	3.6	12.9	1.468
Trichloromonofluoromethane (P11)	137.4	23.7	-1.3	1.485
Tetrachloromonofluoroethane (P134a)	102	-27	71.1	1.21
Dichlorodifluoromethane (P12)	120.9	-29.8	70.3	1.325
Heptafluoropropane (P227)	170	-17	43	1.41





## A Study of Photovoltaic Monocrystalline and Polycrystalline Solar Panel

Jay Kumar Pandey<sup>1\*</sup> and Vikas Kumar Aharwal<sup>2</sup>

<sup>1</sup>Research Scholar, Department Electrical Engineering, Dr. A. P. J. Abdul Kalam University, Indore (M.P.), India

<sup>2</sup>Assistant Professor, Department Electrical Engineering, Dr. A. P. J. Abdul Kalam University, Indore (M.P.), India.

Received: 24 Nov 2021

Revised: 28 Dec 2021

Accepted: 11 Jan 2022

### \*Address for Correspondence

#### Jay Kumar Pandey

Research Scholar,  
Department Electrical Engineering,  
Dr. A. P. J. Abdul Kalam University,  
Indore (M.P.), India.



This is an Open Access Journal / article distributed under the terms of the **Creative Commons Attribution License** (CC BY-NC-ND 3.0) which permits unrestricted use, distribution, and reproduction in any medium, provided the original work is properly cited. All rights reserved.

### ABSTRACT

Renewable energy resources produce energy, especially fossil fuel energy forms, which are highly efficient energy resources. Despite these resources, solar energy appears to be inexhaustible. Photovoltaic (PV) devices can be used to extract this pure and unlimited energy. The production capacity is determined by several parameters, including solar light concentration, local meteorological factors, and the kind of PV component used. The article presents a comprehensive description of the respective solar devices. In particular, it introduces certain unique component approaches and emphasizes PV module functionality, as well as numerous troubleshooting approaches. In this manuscript, research efforts are made to describe the fabrication process as well as module testing standards and methods.

**Keywords:** Photovoltaic (PV), Monocrystalline, Polycrystalline, Solar cells, energy efficiency, Ecosystem

## INTRODUCTION

The community greatly depends on both renewable and nonrenewable forms of resources to perform on a constant routine [1]. The disparity between these two types is that renewable materials can replace them naturally, but nonrenewable resources cannot [2]. Nonrenewable materials are therefore finite in quantity and cannot be exploited indefinitely [3]. There are four major categories of non-renewable materials, i.e., oil, natural gas, coal, and nuclear energy. Except for nuclear energy, all other three are collectively called fossil fuels [4]. Coal is used to create around 55% of India's electricity. Only a small portion of coal power is utilized in electricity production during the overall method and the majority of coal is lost during the transformation operation. In addition to wasting energy, coal-fired energy plants pollute the ecosystem [5]. Sun power is a renewable energy source that has been proven to be highly efficient than other renewable energy resources such as wind, solar, tidal energy [6]. Solar photovoltaic (PV) systems, which transform solar energy into electricity, are amongst the most innovative implication of producing power [7]. A



**Jay Kumar Pandey and Vikas Kumar Aharwal**

Solar Cell is a semiconductor substance composed of a positive-negative diode junction that, when exposed to illumination, causes an electron flow, permitting it to be exploited as a generator of electrical power [8]. Solar cells are generally termed photovoltaic cells since the sun is the intense light source that may be exploited to generate light rays in solar cells. Hence, these are also called "light-electricity" [7]. A variety of solar cells are integrated into a particular region known as the solar panel to encounter the requisite electron transit rate and it is the world's finest efficient, long-lasting, and ecologically beneficial electricity developing device [9]. The photovoltaic phenomenon is the transmission of electrons, also called "current flow," across two strands of photovoltaic modules in a solar panel that is exactly reverse each other because of sun exposure [10]. The greatest prominent methods for power production usually involve monocrystalline silicon, polycrystalline silicon, amorphous silicon, and thin sheets [11]. Irradiance is the radiant flux (power) received by a surface per unit area in radiometry. The watt per square meter ( $Wm^{-2}$ ) is the SI unit of irradiance. In astronomy, the CGS unit erg per square centimeter per second ( $erg\ cm^{-2}\ s^{-1}$ ) is frequently used. Irradiance is often referred to as intensity, although in radiometry, this term is avoided since it can be confused with radiant intensity. Radiant flux is the term used in astronomy to describe irradiance.

The irradiance of a surface per unit frequency or wavelength, depending on whether the spectrum is regarded as a function of frequency or wavelength, is referred to as spectral irradiance. The two types of spectral irradiance have different dimensions: a frequency spectrum's spectral irradiance is measured in watts per square meter per hertz ( $Wm^{-2}Hz^{-1}$ ), whereas a wavelength spectrum spectral irradiance is measured in watts per square meter per meter ( $Wm^{-3}$ ), or more commonly watts per square meter per nanometre ( $Wm^{-2}nm^{-1}$ ).

**Factors affecting Solar Panel efficiency:**

Following are some aspects considered, to ensure that the solar panels are as efficient as possible:

**Temperature**

Owing to the inherent characteristics of the semiconductor substance, the temperature has an impact on the efficacy of photovoltaic cells. As the voltage in between cells reduces, the efficacy of the solar panels rises in cold weather and falls in hot weather as shown in Fig.1 [12].

**Reliability of Power Transition**

Solar energy fabrication is influenced by amends in spectral strength. The efficiency of power fabrication is enhanced by minimizing ambient light reflection as shown in Fig.2 [13].

**The Direction, Propensity, and Altitude, and the temperature**

Accurate assessment of such variables will support to confirm that they generate the highest energy by having attributed to the highest strength of solar energy for the maximum duration.

**Observation and Management**

Distant surveillance and regulation of the PV power plant characteristics and efficiency are the major functions. A comprehensive screening network will offer operational facts, notifications, and statistical data in a prompt, economical, and concise way, allowing any irregularity in the PV plant to be detected.

**Safeguarding**

Servicing solar panels is essential to enhance the quantum of light that can be converted into electricity [14].

**Fabrication of PV Device**

Since an individual cell does not generate adequate energy to fulfill the demand, hence a PV system is developed, by linking solar cells in series to enhance the yield potential [15].

- To enhance the amplitude in the PV circuit, firstly PV module is made by grouping cells in series [16].
- Individual PV modules or PV module strings are then connected in parallel to boost the current flow in the PV system [17].
- Hence, the term "Solar PV grid" refers to a series and parallel arrangement of PV modules [18].





**Jay Kumar Pandey and Vikas Kumar Aharwal****Types of Solar PV Modules: First Generation PV Module**

This type of solar photovoltaic module includes two different forms, of which one is a Monocrystalline and another one is a Polycrystalline module.

**Monocrystalline Solar cells**

A monocrystalline solar panel shown in Fig. 4 is composed of monocrystalline silicon solar cells, and it is prepared by a single silicon ingot silver. Depending upon the integrity of the silicon exploited in its manufacturing, these solar panels possess a highly efficient value and have a dark consistent aspect with curved corners. Monocrystalline cells contain relatively minimal contaminants because they have been made with a uniform consistent crystalline arrangement [19]. These panels are favorably valued in several aspects, including performance, energy density, and affordability, as a result, they attract a considerable rate due to their multiple benefits [20]. Another advantage of solar panels is that they require significantly smaller ceiling areas to produce the same quantity of power.

**Manufacturing Processes**

- The manufacturing of monocrystalline cells is known as the Czochralski method, which entails depositing a silicon crystal "pollen" in a molten silicon vat [22].
- The pollen, as well as the rigid crystalline pattern of melted silicon, known as the ingot which emerges around that, is gradually structured.
- Then, by splitting the firm crystal silicon, it is delicately carved into a silicon sheet, which is eventually turned into a monocrystalline solar module.
- To make silicon wafers, enormous ingots in the shape of cylinders are then chopped on four sides.

**Polycrystalline Solar cells**

The structure of a polycrystalline solar cell differs significantly from that of a monocrystalline. Polycrystalline solar panels exhibit a bluish macular pattern with squared corners as shown in Fig.5.

**Manufacturing Processes**

- Firstly, melted silicon is allowed to settle down in a rectangular tank.
- The cell's squared corners are due to the freezing operation; however, the polycrystalline solar modules have several crystal pieces rather than a single silicon crystal in the tank.

**Experimental setup of PV solar cells (Monocrystalline and Polycrystalline)**

The experimental setup [17], shown below, consists of

- A mounting framework for screens with various inclination angles.
- Two models of PV modules.
- Two rheostats having similar values- used as a plummet for the module.
- Two dc amperage and voltmeters have an identical frequency.
- Linking cables.
- Temperature gauge that is used for temperature monitoring.
- Pyranometer that is used to monitor the strength of solar energy.

**Measurement Process**

- In the first step, two screens on the equivalent mounting framework are placed, so that they receive an equal quantity of sunshine.
- Before incorporating a load, the open-loop potential ( $V_{oc}$ ) and short loop current of each PV screen are monitored.
- As shown in Fig.6, linkages are established for each PV module.
- Following the completion of the couplings, the rheostat is progressively supplied in such a manner that the potential is modulated in sections, with the accompanying power generated in every component being recorded in all steps.
- Equation (1) and Equation (2) are used to compute the productivity and energy for each value [13].





**Jay Kumar Pandey and Vikas Kumar Aharwal**

$$\text{Efficiency} = \frac{\text{Output power}}{\text{Irradiance} * \text{Area}} \quad (1)$$

$$\text{Output Power (P}_{\text{out}}) = \text{Voltage} * \text{Current} \quad (2)$$

## CONCLUSION

In this study, the efficiency of polycrystalline and monocrystalline PV modules of the identical value under numerous diverse circumstances such as irradiance and temperature are evaluated. As per Table I comparative chart between polycrystalline and monocrystalline is given. The existing charge is prejudiced not just by their conventional energy consumption, as well as by their installation technique and meteorological state of affairs such as irradiance and temperature. As a result, the environmental monitoring process of PV panels is essential to provide an appropriate estimate of PV system performance in certain weather. As per the analysis, it has been discovered that Monocrystalline PV modules are more productive than Polycrystalline PV modules and irradiance is directly proportional to the yield power supply developed by the PV module. The differences between Monocrystalline and Polycrystalline solar panels are summarized in the table below.

## REFERENCES

1. Glunz SW, Preu R, Biro D, "Crystalline Silicon Solar Cells: State-of-the-Art and Future Developments". vol. 1. Elsevier Ltd; 2012.
2. Mathew M, Kumar NM, i Korothe, R.P, "Outdoor measurement of mono and poly c-Si PV modules and array characteristics under varying load in hot-humid tropical climate". Mater Today Proc 2018;5(2):3456–64.
3. Ajitha A, Kumar NM, Jiang XX, Reddy GR, Jayakumar A, Praveen K, Kumar TA, "Underwater performance of thin-film photovoltaic module immersed in shallow and deep waters along with possible applications". Results Phys 2019;15:102768.
4. Kumar NM, Sudhakar K, Samykano M, "Performance comparison of BAPV and BIPV systems with c-Si, CIS and CdTe photovoltaic technologies under tropical weather conditions". Case Stud Therm Eng 2019;13:100374.
5. Duflo J, Peeters JR, Altamirano D, Bracquene E, Dewulf W, "Demufacturing photovoltaic panels: comparison of end-of-life treatment strategies for improved resource recovery". CIRP Annals 2018;67(1):29–32.
6. Green MA, Dunlop ED, Levi DH, Hohl-Ebinger J, Yoshita M, Ho-Baillie AWY, "Solar cell efficiency tables" (version 54). Prog Photovoltaics Res Appl 2019;27(7):565–75.
7. Powalla M, Paetel S, Ahlswede E, Wuerz R, Wessendorf CD, Magorian Friedlmeier T, "Thin-film solar cells exceeding 22% solar cell efficiency: an overview on CdTe-, Cu(In,Ga)Se 2-, and perovskite-based materials". Appl Phys Rev 2018;5(4):041602.
8. Slaoui A, Collins RT, "Photovoltaics: advanced inorganic materials". In: Ref. Modul. Mater. Sci. Mater. Eng. 2016.
9. Metaferia W, Schulte KL, Simon J, Johnston S, Ptak AJ, "Gallium arsenide solar cells grown at rates exceeding 300µm h<sup>-1</sup> by hydride vapor phase epitaxy". Nat Commun 2019;10(1):3361.
10. Zou H, Du H, Ren J, Sovacool BK, Zhang Y, Mao G, "Market dynamics, innovation, and transition in China's solar photovoltaic (PV) industry: a critical review". Renew Sustain Energy Rev 2017;69(November 2016):197–206.
11. Simon P, "Photovoltaics report". Freiburg: Fraunhofer ISE; 2019
12. Philipps SP, Bett AW, Horowitz K, Kurtz S, "Current status of concentrator photovoltaic". (CPV) technology; 2017.
13. Sellami N, Mallick TK, "Optical efficiency study of PV crossed compound parabolic concentrator". Appl Energy 2013;102:868–76.
14. Belkasm M, Bouziane K, Akherraz M, Sadiki T, "Optimization of a solar tracker for CPV system principles and practical approach". In: Proceedings of 2014 international renewable and sustainable energy conference, IRSEC 2014; 2014. p. 169–74.



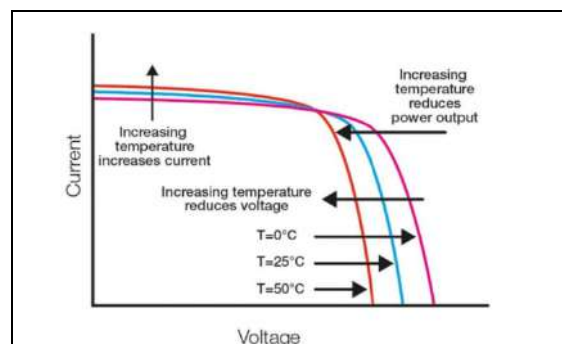


**Jay Kumar Pandey and Vikas Kumar Aharwal**

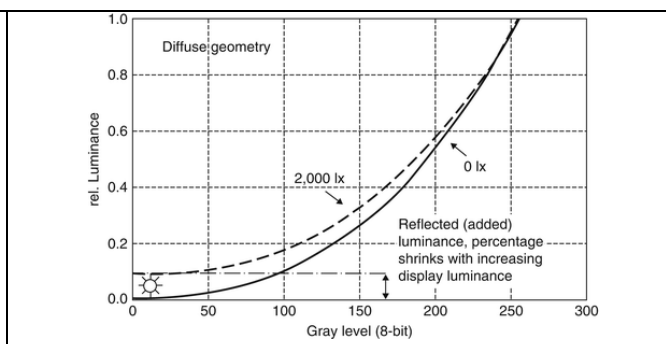
15. Burhan M, Ernest CKJ, Choon NK, "Electrical rating of concentrated photovoltaic (CPV) systems: long-term performance analysis and comparison to conventional PV systems". Int J Technol 2016;7(2):189–96.
16. Kontges M, et al, "Review of failures of photovoltaic modules". 2014. € [21a] Renganathan RMV, Natarajan V, Jahaagirdar T. Failure mechanism in PV systems. In: Grad. course MAE 598 Sol. Commer. 2016. p. 1–17.
17. Rajput P, Malvoni M, Kumar NM, Sastry OS, Tiwari GN, "Risk priority number for understanding the severity of photovoltaic failure modes and their impacts on performance degradation". Case Stud Therm Eng 2019;16:100563.
18. Munoz MA, Alonso-García MC, Vela N, Chenlo F, "Early degradation of silicon PV modules and guaranty conditions". Sol Energy 2011;85(9):2264–74.
19. Aghaei M, "Novel methods in control and monitoring of photovoltaic systems". Politecnico di Milano; 2016.
20. Mathew M, Kumar NM, i Koroath, R.P, "Outdoor measurement of mono and poly c-Si PV modules and array characteristics under varying load in hot-humid tropical climate". Mater Today Proc 2018;5(2):3456–64.
21. Jiyang wang, Haohai Yu, Yan Wang, "Czocharalski and Flux Growth of Crystals for Lasers and Nonlinear Optics" DOI:10.1016/B978-0-444-63303-3.00005-5, December 2015.
22. Leonardo David, "Monocrystalline Vs. Polycrystalline Solar Panels: What's Best?" Eco Watch Solar Energy, 2021 Aug 21.

**Table I: Solar panels: Monocrystalline vs. Polycrystalline [23]**

Parameter	Monocrystalline Solar Panels	Polycrystalline Solar Panels
<b>Material Type</b>	Intrinsic silicon crystalline	Many silicon fragments melded together
<b>Budget</b>	Costly	Cheap
<b>Interface (Panel)</b>	black hue in colored	the blue hue in colored
<b>Performance</b>	High efficiency	Lower efficiency
<b>Duration</b>	Approximately 24 to 39 years	Approximately 19-36 years
<b>Effect of Temperature</b>	The impact of temperature variation is lessened, therefore, more efficient during hot weather.	The higher temperature variation reduces the efficiency of the system.



**Fig.1: The Voltage vs. Current graph [12].**



**Fig.2: The Relative luminance vs. Power Fabrication**





Jay Kumar Pandey and Vikas Kumar Aharwal

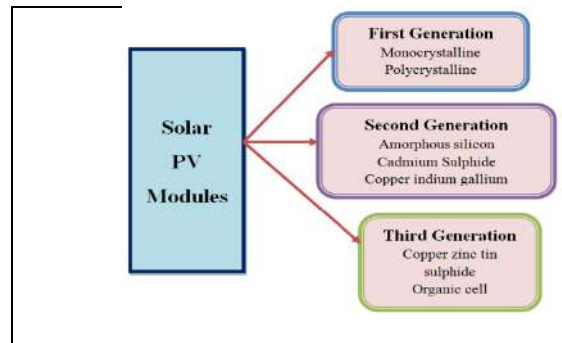


Fig.3: Types of PV Modules [15]



Fig.4: Monocrystalline Solar Panel [17].



Fig.5 Polycrystalline Solar Panel [17]

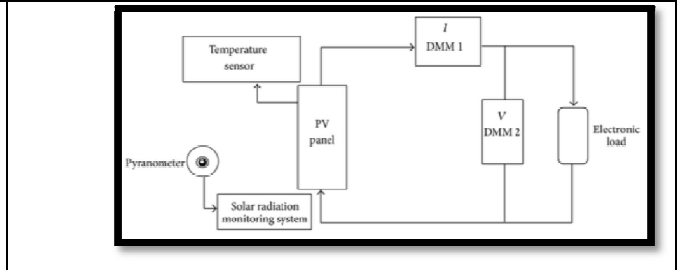


Fig.6 Experimental Setup cum Circuit Diagram of PV Module [17]





## Application of Artificial Intelligence in Medical Education: A Research Analysis

S.Kalarani<sup>1\*</sup> and S.K.Aakash<sup>2</sup>

<sup>1</sup>Professor, Department of Information Technology, St Joseph's Institute of Technology, OMR. Chennai, Tamil Nadu, India.

<sup>2</sup>UG 3<sup>rd</sup> Year Student, Information Technology, St Joseph's Institute of Technology, OMR. Chennai, Tamil Nadu, India.

Received: 23 Oct 2021

Revised: 23 Nov 2021

Accepted: 13 Jan 2022

### \*Address for Correspondence

**S.Kalarani**

Professor,  
Department of Information Technology,  
St Joseph's Institute of Technology,  
OMR. Chennai, Tamil Nadu, India.



This is an Open Access Journal / article distributed under the terms of the **Creative Commons Attribution License** (CC BY-NC-ND 3.0) which permits unrestricted use, distribution, and reproduction in any medium, provided the original work is properly cited. All rights reserved.

### ABSTRACT

Artificial intelligence has been increasingly important as science and technology have progressed, and it has been a major driving factor in the development of a growing number of industries. This article concludes that artificial intelligence can improve the efficiency of medical teaching, improve visual utility, and think more like a human, thus better serving the people, based on research on the application of artificial intelligence in distance medical teaching, virtual inquiry, distance education management, teaching video recording, and other areas. The effects of artificial intelligence in medical education, particularly for improving the overall quality of medical students, provide great inspiration for artificial intelligence applications in medical education.

**Keywords :** Medical Education; Artificial Intelligence; Application ,Research, teaching.

## INTRODUCTION

Artificial intelligence has bright prospects because humans hold high hopes in it, and it can be used to all facets of our lives to improve our general standard of living. Scientists have steadily used artificial intelligence technology to the teaching sector as artificial intelligence technology has progressed, with promising outcomes. As a result, artificial intelligence advancements mixed with education will be an effective new teaching method [1].

### Artificial Intelligence

Artificial intelligence is a relatively new field of study that originated in the mid-twentieth century. This science is primarily associated with computer science [2], but it also encompasses information science, linguistics, psychology,

37784



**Kalarani and Aakash**

philosophy, mathematics, and a variety of other fields. It's a discipline that covers a lot of ground. Computer systems are mostly used in artificial intelligence to replicate human thinking activities. This discipline has a broad research scope and has been applied in a variety of settings[3]. Artificial intelligence is an extremely demanding science category, requiring scientists to have a good knowledge base in all aspects, due to its broad research disciplines. Artificial intelligence research is currently [4] tightly linked to the contemporary demands of humans. Artificial intelligence research has grown in tandem with the passage of time, allowing the technology to be used to increasingly important tasks.

Artificial intelligence's main goal is to make computers have "abilities to acquire and learn knowledge," "abilities to process knowledge," "abilities to interpret language," "the ability to infer and seek automatically," and a variety of other talents[5]. B. Artificial Intelligence Research Content Artificial intelligence can be split into three categories in terms of research objects. The capacity to perform "natural language processing" and develop computer programmes that can be read and spoken is the first. The second goal is to create a machine with sensitive sensory capabilities that can mimic human hearing and vision while also automatically distinguishing between diverse settings. The third type is an R&D expert system, which simulates expert behaviour using a computer. In terms of artificial intelligence research, it can be classified into two categories: theory and engineering. The constant development and expansion of artificial intelligence theory is known as theoretical research. Engineering research is used to develop and design products. These two qualities are inextricably linked and intertwined. Theoretical research offers a theoretical foundation for engineering research, while engineering research puts theory into practise.

**Artificial Intelligence's Technical Aspects**

Search ability, knowledge expression function, reasoning capacity, abstraction ability, speech recognition ability, and ability to interpret fuzzy information are all technical features of artificial intelligence. These five points have essentially allowed artificial intelligence to merely mimic human thought.

**Artificial Intelligence Application In Medical Education**

Artificial intelligence has solved or partially solved several issues in the field of education during the last decade, including language processing, reasoning, planning, and cognitive modelling. Students have additional options to contribute in a digital and dynamic fashion thanks to artificial intelligence. These opportunities are frequently not found in old texts or in the classroom's set atmosphere. Each student has the capacity to progress others through this collaborative learning method, which can speed up the investigation of new learning and the development of creative technologies.

**The Virtual Inquiry System**

DxR Clinician is a virtual patient system for teaching hospitals, medical institutions, and residents that leverages artificial intelligence technology. The approach is commonly utilised in medical student teaching and clinical thought evaluation. The software compiles hundreds of genuine patient data into individual cases, which are then created by specialists and artificial intelligence.

These examples deal with a variety of clinical problems. To diagnose and propose treatment options, medical students use inquiry, simulated physical examinations, and additional examinations of virtual patients to make diagnoses. DxR Clinician can be used by teachers as a beneficial analysis tool to assist them understand their students' behaviour and alter their courses based on the assessment results. Students can gain clinical problem-solving skills quickly. Students can learn a lot about critical disease diagnosis by interacting with the examples. At the same time, the system can detect errors made by students during case study, do deep learning and analysis, and assist students in resolving these issues. Intelligent Tutor Systems, which may follow the learner's "psychological processes" in the process of completing problems to diagnose incorrect notions and evaluate the learners' learning extent of the field, are one type of computer programme that has a similar role to DxR Clinician. The Intelligent Tutor System may also provide learners with timely assistance, feedback, and explanations, as well as encourage self-regulation, self-monitoring, and self-explanation.



**Kalarani and Aakash****Medical Education via the Internet**

Distance education is a type of teaching that is not constrained by time or space, allowing for real-time on-line and off-line instruction. Web-based teaching methods such as micro blogging can be used to facilitate learning, communication, and sharing; virtual simulation training, mobile ward rounds in clinical practise teaching, and mobile nursing all play important roles in medical education, with virtual simulation teaching technology gaining more in-depth and widespread application.

**Artificial Intelligence Technology's Impact on Distance Medical Education Management**

Data centres, teaching resources libraries, and cloud platforms are being built with current information technology for student recruitment, training process management, and evaluation, which can increase the efficiency and service level of continuing medical education management. Modern information technology can be used to share management of the base, institutional management, trainees, project management, evaluation, credit management, and teaching content, such as the creation of a continuing education object database that contains basic information about each student, learning processes, and evaluation conditions, as well as the creation of a national continuing medical education base and institutional management information system. National continuing medical education projects that required online reporting, assessment, and publication were completed in 2021. The computer system can be used to exchange and coordinate common parts in residency training, such as student recruitment, announcement, acceptance, teacher teaching, and course setup. The same information can be transferred by information methods among base hospitals, health administrative departments, clinical teachers, and departments (web pages, mobile phones). Data exchange, knowledge sharing, and corporate collaboration can all be achieved by synchronising courses using computer information systems.

**Videotaping of teachers' lessons**

Outstanding courses relating to medical professions must be recorded, according to the requirements for the establishment of excellent courses. Together with the professional personnel of the College Information Technology Center, the leaders and keynote teachers of the superb course construction team addressed the shooting of classroom instruction films. The shooting plan and process are devised prior to the start of the production. During the shoot, all of the crew members pay close attention to the details. Various superb courses were successfully finished after the post-processing and production process, and the teacher's classroom teaching video was photographed and made. The staffs of the information technology centre assist the lecturers of the superb course building project team in recording classroom teaching videos by combining the construction of all types of medical specialty courses. Courses are recorded as CDs for students to watch over and over after skilled editing by the information technology centre staff. It can assist pupils realise what they didn't understand in class and foster their ability to study on their own.

**CONCLUSION**

The essence of education is accumulation and inheritance, with future generations acquiring the knowledge acquired by their forefathers and being encouraged to create through educational means. Machine learning, artificial neural networks, data mining, and other approaches are used to collect knowledge in artificial intelligence technology. The expert system disseminates and applies knowledge through decision assistance. This article examines how artificial intelligence technology is influencing traditional medical education. Artificial intelligence has a significant impact on medical education by supporting personalised learning, assisting students at various levels, and providing assistance and support when teachers and students require it. Artificial intelligence can not only assist teachers and students in designing courses that match their needs, but it can also monitor student performance and warn teachers to potential difficulties, allowing teachers to improve their teaching methods.

Teachers' roles will be altered by artificial intelligence. Artificial intelligence classes will be supplemented by teachers who will provide students with human connection and practical experience. Students can learn anytime, anyplace with artificial intelligence systems, and some classroom instruction can be replaced by these applications.





**Kalarani and Aakash**

## **REFERENCES**

1. Joshi S. Use of Information Technology in Medical Education [J]. Webmed Central Medical Education, 2010, 1(9): WMC00607.
2. Johnson L, Adams Becker S, Cummins M, et al. NMC Horizon Report 2016 Higher Education Edition [R]. Texas: The New Media Consortium, 2016.
3. Thomas H. Learning Spaces, Learning Environments and Displacement of Learning [J]. British Journal of Educational Technology, 2010, 41 (3): 502-511.
4. Youmei Wang. Cultivating Makers: Educational Ecosystem in the View of New Industrial Revolution [J]. Open Education Research, 2015, (5): 40, 49-56.
5. Xinmin Sang, Yangbin Xie. Improving the Quality of University Teaching in Learning Innovation: The Key to Apply Information Technology in Higher Education [J]. Journal of Higher Education, 2012 (5): 64-69. 34







## An Emerging Trends in Mucoadhesive Drug Delivery Systems

R. Vinoth<sup>1\*</sup>, S. Rani<sup>2</sup> and V. Manikandan<sup>1</sup>

<sup>1</sup>PG Student, Department of Pharmacy, Annamalai University, Tamil Nadu, India.

<sup>2</sup>Associate Professor, Department of Pharmacy, Annamalai University, Tamil Nadu, India

Received: 30 Oct 2021

Revised: 17 Dec 2021

Accepted: 08 Jan 2022

### \*Address for Correspondence

**R. Vinoth**

PG Student,

Department of Pharmacy,

Annamalai University,

Tamil Nadu, India.

Email: vinothbpharm16@gmail.com



This is an Open Access Journal / article distributed under the terms of the **Creative Commons Attribution License** (CC BY-NC-ND 3.0) which permits unrestricted use, distribution, and reproduction in any medium, provided the original work is properly cited. All rights reserved.

### ABSTRACT

Mucoadhesive drug delivery systems are the focus of this article, which examines major new trends and patented innovations in the pharmaceutical industry. As long as the drug has mucoadhesion capability, it will remain in direct range with the mucous membrane, where it will be released and have a greater effect both locally and systemically. Much more attention is being paid to mucoadhesive drug delivery systems because of their numerous advantages, such as improved active substance bioavailability, rapid uptake, and longer retention times. Various factors affecting a dosage form's ability to adhere to mucous membranes and the type of polymers used in the formulation also affect the mucoadhesive ability of the tissue. Many chronic diseases could benefit from its use in the formulation of dosage forms. As a result of the delivery of this system, future treatments for various diseases will be more effective.

**Keywords:** Mucoadhesion, Bioavailability, Patented innovation, Chronic diseases.

### INTRODUCTION

Many low soluble and low permeable drugs have increased bioavailability using mucoadhesive drug delivery system formulations [1]. The term mucoadhesion has gotten a lot of attention in the pharmaceutical industry since the early 1980s [2]. Mucoadhesion has been used for the past 40 years to extend the residence time of various bioadhesive dosage forms and control the release effect via various mucosal routes. Mucoadhesive drug delivery helps to improve absorption and bioavailability of dosage forms due to the greater surface area and increased blood flow in the mucosal cavity. The drug is combined with one or more hydrophilic polymers in the mucoadhesive formulation. Due to its aqueous nature, the drug is released from the system when it comes into contact with saliva or the mucosal layer. A physical interaction helps these systems stick to the mucous membranes at the same time. It is a visco elastic complex mixture of proteins, immunoglobulins, lipids, nucleic acid, enzymes and several ionic species that is secreted by the salivary or epithelial glands. Enhancing the bioavailability and improving the localized

37788



**Vinoth et al.,**

effects of drug delivery systems on various mucus membranes while also increasing the residence time of these polymers has become widely accepted [3]. Recent years have seen the development of a number of mucoadhesive drug delivery systems for administration via the nasal, buccal, oral, vaginal, and rectal. Mucoadhesive Drug Delivery Systems have undergone rapid advancements in recent years, and this review will attempt to summarize the most important ones. It's also a way to draw attention to the patented advancements in mucoadhesive dosage form technology.

### STRUCTURE OF MUCOUS LAYER

The moist connective tissue layer (the *Lamina propria*) is covered in mucus and is known as the mucous membrane (mucosae). It is present in the ocular, vagina, cornea, and esophagus, these epithelia can be multilayered / stratified or single layered, depending on the body cavities. Though it is relatively permeable, this membrane has demonstrated a high ability to absorb active moiety, allowing drugs to be absorbed quickly [4-5]. Goblet cells produce mucus, a thick, viscous fluid. These glandular cells are synthesized not only through specialized glands such as the salivary glands, but also in every epithelium layer exposed to the external environment. In humans, the average thickness of this layer ranges between 50 and 450 m. Figure 1 depicts the structure and components of the mucous membrane. Protection against infectious agents like fungi, bacteria, and viruses is the primary function of the mucous membrane [6]. Mucosal drainage contains either a gel layer attached to the mucosal surface or luminal soluble or suspension form mucus. Keeps mucus moist by acting as a lubricant. Mucopolysaccharides, Glycoproteins, inorganic salts, proteins, lysozyme, lipids, IgA and 95 percent water make up this highly hydrated system, which is why mucin is responsible for the gel's structure and appearance.

### BIOADHESION AND MUCOADHESION

It is possible to define bio adhesion as the state in which interfacial forces hold two materials together for a long time, at least one of which is biological in nature. Bio adhesion in biological systems can be divided into three types: There are three types of bio adhesion in biological systems:

1. Type 1 adhesion, for example, platelet aggregation and wound healing, occurs when two biological phases are in contact.
2. Type 2 adhesion, for example, Biofilm formation on prosthetic devices and inserts and cell adhesion to culture dishes.
3. Type 3 adhesion, for example, synthetic hydrogels adhering to soft tissues or dental sealants sticking to enamel[7].

When it comes to mucoadhesion, it is an interfacial phenomenon in which interfacial attraction forces hold two materials together, one artificial like mucoadhesive polymer and the other the mucin layer of mucosal tissue. The mucous membrane acts as a semi-permeable barrier system, allowing some small molecules and ions to pass through [8]. Because mucoadhesive systems allow for multiple administration routes and their composition varies depending on the characteristics of the administration site, they are both convenient and versatile [9-12]. The route of administration is buccal or gastrointestinal as well as vaginal or ocular or rectal.

### MECHANISMS AND THEORIES OF MUCOADHESION

The wetting, adsorption, and interpenetration of polymer chains all play a role in mucoadhesion. is highly dependent on a variety of variables, including mucoadhesive material, formulation, mucous membrane nature, the bond's subsequent environment, and attachment method. The mechanism of mucoadhesion is illustrated in greater detail in Figure 2 [13]. There are generally two stages to mucoadhesion.

#### Contact stage

An intimate wetting or swelling occurs between the mucoadhesive and mucous membrane, at this stage, it will make contact with the mucous membrane. The mucus in the mucosal membrane wets the mucoadhesive to make it stick.





Vinoth et al.,

### Consolidation stage

Water activates the mucoadhesive materials during this stage. Plasticizing the system with water makes it easier for molecules that are normally stuck to the mucosa to dislodge. The mucoadhesive material is joined to the mucus membrane by these forces of attraction, resulting in a long-lasting mucoadhesion. Consolidation is what we're calling this phase right now. The process of mucoadhesion is complete after these two stages [14].

### Theories

Mucoadhesion is a complicated process that has spawned a slew of hypotheses about how it works. Electrostatics, mechanical interlocking, adsorption, diffusion interpenetration, and fracture processes are some examples of these theories [15].

1. Fracture theory
2. Diffusion interlocking theory
3. Adsorption theory
4. Wetting theory
5. Electronic theory

### FACTORS AFFECTING MUCOADHESION

#### Polymer related factors

The mucoadhesion is determined by the dosage form's active polymer properties. There are several factors that can influence mucoadhesion in polymers, including concentration, molecular weight, polymer chain flexibility, hydration/ swelling, polymer charge, cross linking density, hydrogen bonding capacity, and specific spatial confirmation[16].

#### Factors connected to the environment:

Several factors influence mucoadhesion, including pH at the polymer-substrate interface, the applied functional strength, the duration of first contact, and moistening after first contact.

#### Physiological factors

The factors that can affect mucoadhesion include disease state, mucosal cell renewal rate, concurrent diseases, mucin turnover, and tissue movement [17].

### MUCOADHESIVE MATERIALS

Several administration routes have utilized bioadhesive materials as absorption promoters. Many organic functions such as carboxyl, hydroxyl, and amino groups generate hydrogen bonds in natural or synthetic hydrophilic molecules which are used to make these materials, which do not adhere to specific surfaces. Rheological properties can explain mucoadhesion in gels made from liquid crystals or environmentally sensitive polymers. Mucociliary clearance is slowed down, and the formulation has more time to get in contact with the mucous membrane as a result [6]. In addition to the drug substances, bioadhesive polymers, backing membranes (for buccal), and permeation enhancers are included in the mucoadhesive materials.

### MUCOADHESIVE POLYMERS

Adhesion to the mucous membrane is the basis for mucoadhesive drug delivery systems. The formulation contains a mucoadhesion-promoting agent or polymer that aids in the active pharmaceutical ingredient's adhesion to the oral mucosa. While most mucoadhesive polymers are water soluble, it's possible to find a few that aren't. Swellable networks are a feature of these polymers. A small number of cross-linking agents are used to connect networks together. The properties of these cross-linking agents, such as ease of wetting, better mutual adsorption, and better penetration and interpenetration within the polymer and oral mucus, are all required for mucoadhesion [18-20]. Mucoidal mucoadhesive materials such as alginates, chitosan's, cellulose derivatives, and carbomers were found to have the greatest utility as denture fixers. Generally, there are three kinds of these category;



**Vinoth et al.,****Cationic**

Because it has a charge that is negative at physiological pH, Cationic molecules can interact with mucous membrane surfaces. Mucoadhesion occurs as a result of electrostatic interactions between mucin, which contains both sialic and amino groups, and the mucous layer.

**Anionic**

Rather than simply being mucoadhesive, synthetic polymers like carbomer (derived from polyacrylic acid) have a negative charge as well as being mucoadhesive. Polyacrylic acid hydrogels are a wide-ranging application of mucoadhesive systems because of their utility in such conditions, their physicochemical outcomes and parameters, as well. (for example: hydrophobic interactions and van der Waals and hydrogen bonds).

**Non-ionic polymers**

There are currently weaker mucoadhesion forces in nonionic polymers than anionic polymers, including hydroxyl propyl-methyl cellulose, hydroxyethyl cellulose, and methylcellulose [6].

**CLASSIFICATION OF MUCOADHESIVE POLYMERS**

There are two main types of mucoadhesive polymers:

**Natural polymers**

Derived from the natural origin for example chitosan, dextran, cyclodextrins, starch, hyaluronic acid extra, alginates, agarose, collagen, albumin, gelatin, cellulose,

**Synthetic polymers**

These are further divided into two categories

- A) Bio-degradable polymers: Poly-Doxanones, Polyphosphonates, Polyurethanes, Polyacetals, Polylactic acid, Polysebacic acid, Polyhydroxyl butyrate, Polyphosphates, Polyphosphazenes, Polyglycolic acid, Polycaprolactone, Polyadipic acid, Polyterphthalic acid, Poly imino carbonates, Poly amino acids, Poly-ortho esters etc [21].
- B) Non-biodegradable polymers: Cellulose acetate HPMC, Carboxymethylcellulose, polydimethylsiloxanes, Ethylcellulose, Polymethacrylates, Colloidal silica, Poloxamines etc. Chitosan, Carbopol, Alginate, Sodium carboxymethyl cellulose (Na CMC), and Hydroxypropyl methylcellulose are some of the most widely used polymers in mucoadhesive drug delivery systems.

**MULTIPARTICULATE MUCOADHESIVE FORMULATION**

An abundance of distinct particles is created by the bioavailability and effective delivery of gas emergent components as well as the number of film layers, which include a mucoadhesive, strong material-containing layers, and an interlining layer that regulates the specifications of active material liberates. Polymer-enclosed active ingredients are enveloped in a polymer that contrasts with stomach acid, but this results in intestinal juice permeability. A minimum of one active moiety, in the form of multiparticulate groundworks, has mucoadhesive properties. In addition, a blowing agent is included, which comes into contact with liquid and turns it into gas. In the following trend, discrete particles shield themselves from being overtaken by polymers (which are soluble in intestinal fluid but resistant to gastric fluid)[22].

1. It is necessary to use a vacuum to move the polymer materials from the molding board in association with bores the process for constructing polymer enclosure compartments.
2. After that, the active material is packed and properly fulfilled, including the preparation of blowing agents as well as their formation.
3. Replacing the polymer web and locking the compartments with high pressure and high temperature is the third step.



**Vinoth et al.,****VARIOUS MUCOADHESIVE FORMULATIONS FOR THE ADMINISTRATION OF DRUGS [23-24]****Type of dosages form**

1. Double layered mucoadhesive tablets
2. Chemically modified beta-cyclodextrin complexes
3. Buccal liposomal delivery
4. mucoadhesive tablets
5. Mucoadhesive microcapsules

**Formulations for rectal drug delivery that use mucoadhesive formulations:**

1. Tropical delivery of inflammatory bowel disease
2. Controlled release of solid-reserved micellar solution and suppositories

**Formulations for nasal drug delivery that use mucoadhesive formulations**

1. Micro particulates
2. Organogel components intranasal delivery
3. Nasal administration of chitosan based microspheres
4. Transdermal ionophoretic delivery
5. Drug transfer on all parts of the human nasal epithelial cell monolayer

**Formulations for ocular drug delivery that use mucoadhesive formulations**

1. The retina and the pigment epithelium of the retina are both targeted in ocular drug delivery.
2. Nanoparticles made of chitosan as a new drug delivery system for the eyes.

**ADVANTAGES OF MUCOADHESIVE DRUG DELIVERY SYSTEMS [27]**

1. Improved patient compliance, as evidenced by the preceding point.
2. The acidic environment of the GIT protects the drug from degradation.
3. Increases bioavailability by prolonging residence time of dosage form at site of absorption
4. It's easily accessible and takes effect quickly.
5. Because of the large blood supply and high blood flow rates, rapid absorption is possible.
6. Passive diffusion is responsible for drug absorption.

**CONCLUSION**

As a means of enhancing the therapeutic efficacy of medications, the use of bioadhesive resources on mucosal layer surfaces has stimulated the interest of researchers working on mucoadhesive drug delivery systems. Mucoadhesion can serve as a model for various drug delivery approaches, including controlled release. There is good vascular and lymphatic drainage of the mucosa and pre-systemic metabolism in the liver and gastrointestinal elimination is avoided in the digestive tract. Longer drug residence time increases absorption and bioavailability of many poorly soluble and poorly permeable drugs, according to a recent patented innovation. Additionally, it uses the potential benefit of additional reproducible drug bioavailability to coordinate gastrointestinal transit time. Research on mucoadhesion has wide applicability. Delivering this system will therefore improve future treatment effectiveness for a wide range of diseases.

**REFERENCES**

1. Singh R, Sharma D and Garg R, Review on Mucoadhesive Drug Delivery System with Special Emphasis on Buccal Route: An Important Tool in Designing of Novel Controlled Drug Delivery System for the Effective Delivery of Pharmaceuticals, Journal of Developing Drugs; 2017; 6(1); 1-12.



**Vinoth et al.,**

2. Sharaf Alawdi, Ajay B, Solanki, Mucoadhesive Drug Delivery Systems: A Review of Recent Developments, Journal of Scientific Research in Medical and Biological Sciences; 2021; 2(1); 50-64.
3. Senthil KM, Mucoadhesive Buccal Drug Delivery System – An Overview, International Journal of Pharmacy & Technology; 2012; 4(8); 3951-3969.
4. Carvalho FC, Bruschi ML, Evangelista RC, Mucoadhesive drug delivery systems, Brazilian Journal of Pharmaceutical Sciences 2010;46(1); 1-18.
5. Khan AB, Mahamana R, Pal E. Review on mucoadhesive drug delivery system: novel approaches in modern era, Science Journal of Pharmaceutical Sciences, 2015; 4(4); 128-41.
6. Smart JD, The basics and underlying mechanisms of mucoadhesion. Advanced Drug Delivery and Research. 2005; 57(11); 1556-68.
7. Longer MA, Robinson JR. Fundamental aspects of Bioadhesion. Pharmacy International, 1986;7(3); 114-123.
8. Khutoryanskiy VV. Advances in mucoadhesion and mucoadhesive polymers. Macromolecular Biosciences 2011; 11; 748-764.
9. Jasti B, Li X, Cleary G. Recent advances in mucoadhesive drug delivery system. Drug delivery polymers, Business briefing. Pharma technology 2003; 194-196.
10. Wong CF, Yuen KH, Peh KK. Formulation and evaluation of controlled release Eudragit buccal patches. International Journal of Pharmacy; 1999; 178; 11-22.
11. Navgire SD, Satpute AS, Pandey S, Patil AT. Recent patents on oral insulin delivery. Recent Patented Drug Delivery and Formulations; 2014; 8(3); 202-205.
12. Tartara LI, Palma SD, Allemanni D, Ahumada MI, Llabot JM. New mucoadhesive polymeric film for ophthalmic administration of acetazolamide. Recent Patented Drug Delivery and Formulations 2014; 8(3); 224-232.
13. Mamatha Y, Prasanth VV, Arun KS, Altaf BMS, Vandana Y, Buccal Drug Delivery: A Technical Approach. Journal of Drug Delivery & Therapeutics; 2012; 2: 326-329
14. Akhtar M.H., Gupta J., Mohuddin M., Faisal M.D., A comprehensive Review on Buccal Drug Delivery System, International Journal of Pharmaceutical Research and Development, 2017; 3(11); 59-77.
15. G.P. Andrews et al., Mucoadhesive polymeric platforms for controlled drug delivery, European Journal of Pharmacy and Biopharmaceutics, 2009; 71; 505-518.
16. Gandhi RB, Robinson JR. Bioadhesion in drug delivery. Indian Journal of Pharmaceutical Sciences, 1988;50;145-52.
17. Jimenez-Castellanos MR., Zia H, Rhodes CT, Binding of acrylic polymers to mucin/epithelial surfaces: Structure-property-relationship. Drug Delivery in Indian Pharmaceuticals, 1993; 19: 142-143.
18. Chatterjee B, Amalina N, Sengupta P, Mandal UK. Mucoadhesive polymers and their mode of action: a recent update. Journal of Applied Pharmaceutics 2017;7;195-203.
19. Anders R, Merkle HP. Evaluation of laminated muco-adhesive patches for buccal drug delivery. International Journal of Pharmacy, 1989;49; 231-40.
20. Sonawane M, Shinkar DR. Mucoadhesive buccal drug delivery system: review article. International Journal of Current Pharmaceutical Sciences, 2017;9; 1-14.
21. Mangaraj S, Yadav A, Bal LM, Dash SK, Mahanti NK. Application of biodegradable polymers in food packaging industry: a comprehensive review. Journal Packaging Technology and Research, 2019;3; 77-96.
22. Solomonidon D, Krumme M, Asmussen B, Kreuter J. Multiparticulate mucoadhesive preparation. United States patent 20040137174, 2004.
23. Llabot JM, Manzo RH, Allemanni DA. Double-layered mucoadhesive tablets containing nystatin. American Association of Pharmaceutical Scientists, Pharmaceutical Science and Technology, 2002;3(3); E22.
24. Chowdary KP, Rao YS. Design and in vitro and in vivo evaluation of mucoadhesive microcapsules of glipizide for oral controlled release: a technical note. American Association of Pharmaceutical Scientists, Pharmaceutical Science and Technology, 2003;4(3); E39.
25. El-Samaligy MS, Afifi NN, Mahmoud EA. Increasing bioavailability of silymarin using a buccal liposomal delivery system: preparation and experimental design investigation. International Journal of Pharmacy, 2006;308(1-2); 140-148.





## Vinoth et al.,

26. Giannola LI, De Caro V, Giandalia G, Siragusa MG, Tripodo C, Florena AM, et al. Release of naltrexone on buccal mucosa: permeation studies, histological aspects and matrix system design. *European Journal of Pharmacy and Biopharmaceutics*, 2007;67(2): 425-433.
27. Tangri P., Khurana S., Madhav N.V.S., Mucoadhesive Drug Delivery System: Material and Method, *International Journal of Pharmaceutical and Biological Sciences*, 2011; 2(1); 34-46.

**Table 1. Recent Patented Innovations In Mucoadhesive Drug Delivery Systems [25-26]**

Patent No	Title of the patent	Types of delivery systems	Major invention
WO/2015/126841	Nutritional and therapeutic mucoadhesive formulations	Liquid or Gel	It is described and used for delivery to mucosal surfaces, as a supplement formulation that includes a mucoadhesive and an effective amount of one or more medicinal foods or nutritional supplements. There are two possible supplement formulations: gel or liquid.
EP2298284	Mucoadhesive pharmaceutical formulations	Suppositories, Emulsions	As a result of the innovation, pharmaceutical dosage form constituents are now available that can be used to apply lipophilic drugs to a mucosal layer's surface, where the lipophilic drugs can attach to the mucosal layer's surface and be released slowly over time.
US20100144618	Constituents including a trefoil peptide of the intestine as well as of a mucoadhesive	Oral spray, Oral rinse, Ointment, Paste, Cream, Gel, Chewing gum, Chewable Tablet, Lozenge, Bioerodable film.	Components containing an intestinal trefoil peptide and a mucoadhesive excipient are included in the innovation. Constituents such as an intestinal trefoil peptide and a mucoadhesive excipient could be prepared in combination with one or more therapeutics.
US8703177	Abuse-impervious mucoadhesive tools for release of buprenorphine	Patches	Buprenorphine is released through the use of mucoadhesive tools for abuse prevention. Buprenorphine absorption is optimized by using a pH-selected mucoadhesive layer, usually a backing layer, and a pH-selected layer in each machine.
US20150174076	Mucoadhesive tools for release of active agents	Wafers	A transmucosal release technique is described here. One or more mucoadhesive tools for the release of an active agent may be included in a system's personification.
US8529939	Mucoadhesive drug delivery tools and methods of preparing and utilizing	Wafer, Tablet, Cylinder, Sheet, Particles or Sphere.	The discovery is based on the development in this instance and the use of mucoadhesive drug delivery tools. It includes more refined biocompatible proteins combined with one or more biocompatible solvents, as well as one or more mucoadhesive agents of varying strengths.





Vinoth et al.,

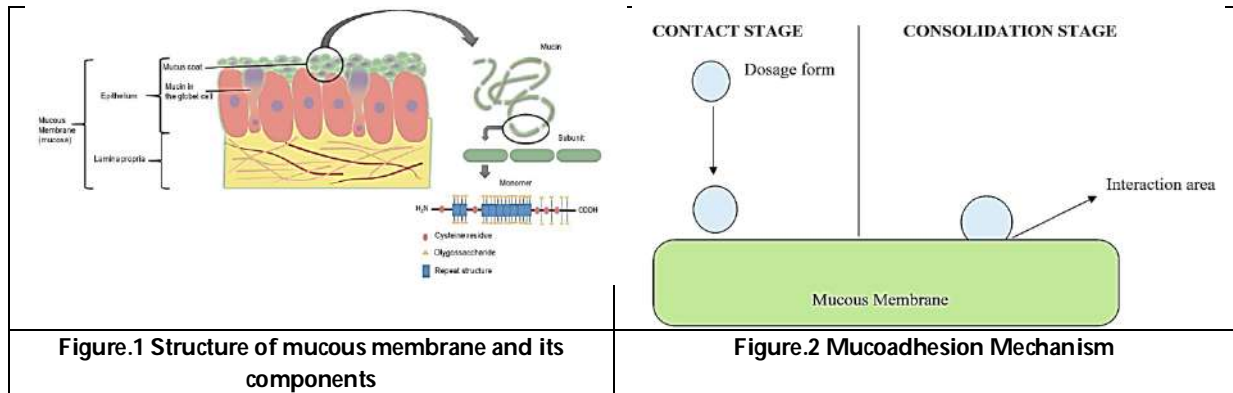


Figure.1 Structure of mucous membrane and its components

Figure.2 Mucoadhesion Mechanism







## Experimental Study on Durability Property on Geopolymer Concrete by using Metakaolin and M-Sand

J.Rex<sup>1</sup>, Allam Aravind Kumar<sup>2\*</sup> and J.SelwynBabu<sup>1</sup>

<sup>1</sup>Assistant Professor, Department of Civil Engineering, Malla Reddy Engineering College, Hyderabad, Telangana, India.

<sup>2</sup>PG Scholar, Department of Civil Engineering, Malla Reddy Engineering College, Hyderabad, Telangana, India.

Received: 25 Nov 2021

Revised: 23 Dec 2021

Accepted: 12 Jan 2022

### \*Address for Correspondence

**Allam Aravind Kumar**

PG Scholar,

Department of Civil Engineering,

Malla Reddy Engineering College,

Hyderabad, Telangana, India.

Email: allamaravind1111@gmail.com



This is an Open Access Journal / article distributed under the terms of the **Creative Commons Attribution License** (CC BY-NC-ND 3.0) which permits unrestricted use, distribution, and reproduction in any medium, provided the original work is properly cited. All rights reserved.

### ABSTRACT

Research for complete OPC free concrete is still evolving and there is a need for developing alternative binding agents which are environmentally friendly. Geopolymer, which is made out of fly ash, sodium silicate, and sodium or potassium hydroxide, is one such option (NaOH or KOH). Since several coal-fired power stations in India have been shut down owing to a push for greener energy, there may be a scarcity of fly ash in the future. The demand for concrete in the building industry has boosted the production of ordinary Portland cement and the use of ordinary river sand. Due to unlawful mining of river sand, CO<sub>2</sub> emissions grow during cement manufacture, while river sand supply becomes more expensive and scarce. The major goal of this study article is to focus on environmentally acceptable alternatives to cement and river sand. As a result, the goal of this research is to include different Pozzolanic elements in geopolymer concrete. Two Pozzolanic materials, metakaolin and M-sand, were utilised to substitute fly ash in geopolymer concrete and the proportion of M-sand in lieu of river sand, respectively. Concrete mix design of M30 were done based on Indian standard code guidelines. Concrete cubes specimens were tested for evolving the strength and durability by varying the percentages of metakaolin and M-sand in concrete. The percentage replacement of metakaolin and M-sand in Geopolymer concrete by using 0%MK+0%M-sand, 2.5%MK+5%M-sand, 5%MK+10% M-sand, 7.5%MK +15%M-sand, 10%MK+20%M-sand. The various tests like compressive, tensile, flexural and Durability tests are performed on geopolymer concrete by varying percentages of metakaolin and M-sand.

**Key words:** OPC, geopolymer, sand, metakaolin, strength, durability, concrete





Rex et al.,

## INTRODUCTION

India's economy is expanding. Infrastructure facilities will be improved in order to compete on a global scale. The increase in construction activity raises demand for cement, which is the most often used construction material. One tonne of cement produced emits one tonne of CO<sub>2</sub> into the environment. Geopolymer is provided as an alternative building material in this study. Geopolymer is made without the need of cement. Depending on the starting material, geopolymers can be synthesised to be as strong as and more durable than cement concrete. Geopolymers are self-curing in temperate areas, therefore there is no need to cure them. In cooler climates, precast goods can be used. Because raw ingredients are readily available, geopolymer concrete is a feasible alternative to cement concrete, and its carbon footprint is significantly lower than cement. This study examines the performance of fly ash as a geopolymer precursor in order to address the rising need for a dependable and efficient material in the building sector. Because it is extremely reactive, it builds strength quickly. Fly ash-based geopolymer concrete also decreases carbon dioxide emissions by replacing cement and gaining carbon credit. The experimental investigation was conducted to study the strength and durability of fly ash based geo polymer concrete is made the trials are assumed with varying percentages of metakaolin and m sand mix by using 0%MK+0%M-sand, 2.5%MK+5%M-sand, 5%MK+10% M-sand, 7.5%MK +15%M-sand, 10%MK+20%M-sand.

## MATERIALS USED

### Metakaolin

Metakaolin is manufactured under strict circumstances to improve its colour, eliminate inert impurities, and tune particle size to achieve a high degree of purity and pozzolanic reactivity. Metakaolin is a white, amorphous, extremely reactive aluminium silicate pozzolan that, when mixed with lime stone in water, forms stable hydrates and gives mortar hydraulic qualities. The metakolin sample is shown in the below figure 1.

### Fly ash

Fly ash, also known as "pulverised fuel ash" in the United Kingdom, is a coal combustion product made up of particulates (fine particles of burnt fuel) and flue gases that are expelled from coal-fired boilers. Bottom ash is ash that settles at the bottom of the boiler. The fly ash sample is shown in the below figure 2.

### M Sand

River sand can be replaced by manufactured sand. The demand for sand has risen dramatically as a result of the fast-growing construction sector, resulting in a scarcity of adequate river sand in most parts of the world. The M Sand sample is shown in the below figure 3

### Coarse aggregates

As coarse aggregate, crushed granite stone aggregate with a size of 10mm was employed. For the experiments, coarse aggregate flowing through 10mm and retaining 4.75mm was employed.

### Fine aggregates

In this experiment, the locally accessible river sand with a grain size of 4.75 mm. Fine aggregate characteristics were assessed according to IS: 2386-1963.

### Alkaline solution

As an alkaline solution, a mixture of sodium silicate solution and sodium hydroxide solution was utilised.



**Rex et al.,****Sodium hydroxide**

Water, ethanol, and methanol are all soluble in sodium hydroxide. This alkali is deliquescent, absorbing moisture and carbon dioxide from the air quickly. Pure sodium hydroxide is a yellowish substance that can be purchased as pellets, flakes, granules, or as a solution.

**Sodium silicate**

Compounds having the formula  $\text{Na}_2(\text{SiO}_2)_n\text{O}$  are known as sodium silicates. Most masonry products, such as concrete, can be treated with a sodium silicate solution to dramatically reduce porosity. The additional  $\text{Ca}(\text{OH})_2$  (portlandite) in the concrete causes a chemical reaction that permanently bonds the silicates to the surface, making them significantly more robust and water resistant.

**Admixture**

To acquire workability of clean Geopolymer Concrete, Sulphonated naphthalene polymer based totally wonderful plasticizer Conplast SP430 in the form of a brown liquid immediately dispersible in water, Use of superplasticizer allows for a water reduction of up to 30% without lowering workability, compared to a possible reduction of up to 15% with plasticizers. The use of superplasticizer is common in the manufacture of flowing, self-leveling, self-compacting, and high-strength, high-performance concrete.

**METHODOLOGY**

In order to test the strength and durability of geopolymer concrete using metakolin and M sand for compressive strength, split tensile strength, flexural strength and durability of various curing periods. Along with those strength tests workability is also studied for various trial mixes. For this project the following methodology is used.

**Batching**

Batching is the process of taking the quantity of materials required for the project. Generally measuring the material quantity is done by two methods one is weight batching, second is volume batching. In the present study weight batching is considered to measure the materials quantity.

**Mixing of the concrete**

After measuring the materials quantity mix the materials as per the trails. Firstly we have to mix coarse aggregates, fine aggregates, metakolin, fly ash and m sand for some time to get uniform mix after that add alkaline solution to the mixture again mix for some more time to get same mix throughout the material. Now add the water as per the calculations from the mix design to make freshly prepared concrete for M30 grade concrete.

**Casting of specimens**

After mixing the concrete materials we have to cast the specimens like cubes, cylinders, prisms to check the strength and durability at 7 days, 14 days and 28 days curing period along with these strength we have to cast 15 cubes for the durability of concrete for these five trial mixes.

**Curing of the Specimens**

In case of compressive strength, split tensile and flexural strength studies we have to cure the specimens for 7 days, 14 days and 28 days of curing periods with all five trial mixes. While in case of durability we have to cure the specimens to at least for acid attack and alkaline attack tests.

**Mix trials used**

The following are the trial mixes used for the project they are named as M0, M1, M2, M3 and M4. The details are given in the below

1. M0 - 0%MK+0%M-sand



**Rex et al.,**

2. M1- 2.5%MK +5%M-sand
3. M2- 5%MK +10%M-sand
4. M3- 7.5%MK +15%M-sand
5. M4- 10%MK +20%M-sand

## RESULTS AND ANALYSIS

### Workability of Concrete

Workability is one of the most important property of the freshly prepared concrete mixtures in the present study workability of concrete mix is find out with the help of the slump cone test and compaction factor tests the below graph shows the slump cone comparison for various mixes.

### Compaction Factor

Compaction factor is the weight of partially compacted concrete to the weight of full compacted concrete. For the present study compaction factor is determined with the help of mix trials from mix trial 1 to mix trial 5 the below graph shows the compaction factor test results.

### Compressive Strength of Concrete

After curing cubes the compressive strength of concrete is resolved with the assistance of universal testing machine (UTM) for trial 1 to trial 5. The below figure shows the compressive strength of concrete for 7 days, 14 days and 28 days curing.

### Split Tensile Strength

Split tensile strength of concrete is determined for M35 grade concrete with the help of cylinder specimens for various mix trials from trial 1 to trail. The dimension of the cylinder was taken as 150mm diameter and 300mm length. The below graph shows the split tensile strength for 7days, 14 days and 28 days.

### Flexural Strength of Concrete

Generally flexural strength of concrete is determined for prism specimens of 150mmX150mmX700mm dimensions. The flexural strength of prism specimens is determined for trials 1 to trails 5 for M35 grade concrete, the below graph shows the flexural strength of concrete for 7days, 14 days and 28 days curing.

### Durability of Concrete

Durability is one of the most critical pieces of concrete on account of its focal rate in the usefulness life of structures. In such manner, breaking accept a key activity in the quality of strong structures. Durability is one of the most significant viewpoint in concrete this property is controlled by restoring the block samples in corrosive arrangement and basic arrangement the beneath chart shows the rate loss of weight and rate loss of compressive quality for both relieving techniques.

## CONCLUSIONS

From the above experimental study the following conclusions were made

1. At typical operating room temperature, geopolymer concrete tends to display no substantial physical changes in its characteristics, as is the case with ordinary concrete. Geopolymer concrete specimens can take up to 72 hours to fully set without leaving any reminiscences on the surface they are hardened on.
2. The value of slump decreases from 60mm to 25mm with increase in the percentage of metakolin and M Sand from 0%+0% to 10%+20%.
3. The value of compaction factor increases 0.84 to 0.95 for M30 Grade concrete with increase in the percentage of metakolin and M Sand from 0%+0% to 10%+20%.



**Rex et al.,**

4. For 7 days, 14 days, and 28 days, the ideal value (highest value) of compressive strength was recorded at 7.5 percent MK+15 percent M-sand (M3).
5. For 7 days, 14 days, and 28 days, the ideal value (highest value) of Split tensile strength was recorded at 7.5 percent MK+15 percent M-sand (M3).
6. Flexural strength was shown to be optimal (highest) at 7.5 percent MK+15 percent M-sand (M3) for 7 days, 14 days, and 28 days.
7. The resistance of concrete to acid, alkaline, and sulphate attack improves as the amount of metakolin and M Sand rises.
8. Fly ash may be utilised to make a geo polymeric binder phase that can bind fine and coarse aggregate systems together to generate geo polymer concrete. As a result, this concrete might be called an environmentally benign material. The higher the ratio of sodium silicate to sodium hydroxide by mass, the higher the compressive, flexural, and split tensile strengths.
9. Increased sodium hydroxide solution content (in terms of molar) leads in higher compressive strength of fly ash based geo polymer concrete. The compressive strength of fly ash-based geo polymer concrete increases as the sodium silicate-to-sodium hydroxide ratio by mass increases.

**REFERENCES**

1. Prof. Jamdade P.K, Prof. Kawade U.R, (2014), Evaluate Strength of Geopolymer Concrete by Using Oven Curing, IOSR Journal of Mechanical and Civil Engineering, 11, 63-66.
2. Krishnan L, Karthikeyan S, Nathiya S, Suganya K, (2014) Geopolymer concrete an eco-friendly construction material, International Journal of Research in Engineering and Technology,3, 164-167.
3. Ali A. Aliabdo, Abd Elmoaty M, Abd Elmoaty, Hazem A. Salem, (2016) Effect of cement addition, solution resting time and curing characteristics on fly ash based geopolymer concrete performance, Journal of Construction and Building Materials, 123, 581-593.
4. DjwantorHardjito, Chua Chung Cheak, Carrie Ho Lee Ing (2008) Strength and Setting Times of Low Calcium Fly Ash-based Geopolymer Mortar, Modern applied science,2, 3-11.
5. Rashida A Jhumarwala, Rao P.S, Patel T.N (2013) Experimental Investigation on Self Compacting Geopolymer Concrete (SCGC), Paripex - Indian Journal Of Research, 3, 173-175.
6. Sashidhar C, Guru Jawahar J, Neelima C, Pavan Kumar D (2015) Fresh and Strength Properties of Self compacting Geopolymer Concrete Using Manufactured Sand, International Journal of ChemTech Research,8, 183- 190.
7. Usha T G, Anuradha R, Venkatasubramani G S (2015) Performance of self compacting geopolymer concrete containing different mineral admixtures, Indian journal of engineering and material sciences, 22, 473-481.
8. Shankar H. Sanni, Khadiranaikar R.B (2013) Performance of alkaline solutions on grades of geopolymer concrete, International Journal of Research in Engineering and Technology, 366-371
9. Faiz Uddin Ahmed Shaikh (2016) Mechanical and durability properties of fly ash geopolymer concrete containing recycled coarse aggregates, International Journal of Sustainable Built Environment.
10. Sabina Kramar, Vilma Ducman (2015) Mechanical And Microstructural Characterization of Geopolymer Synthesized From Low Calcium Fly Ash, Chemical Industry & Chemical Engineering Quarterly,21, 13-22.
11. Emad Benhelal, Gholamreza Zahedi, EzzatollahShamsaei, Alireza Bahadori (2013) Global strategies and potentials to curb CO2 emissions in cement industry, Journal of Cleaner Production,142-161.
12. Daniel L.Y. Kong, Jay G. Sanjayan (2010) Effect of elevated temperatures on





**Rex et al.,**



**Figure 1: Metakaolin sample**



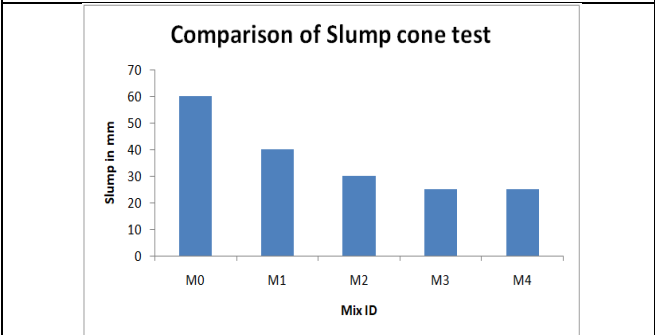
**Figure 2: Fly ash**



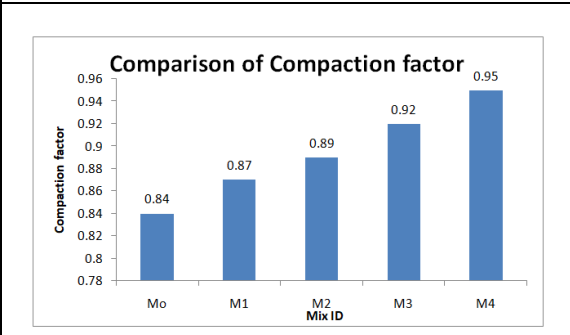
**Figure 3: M Sand**



**Figure 4: Conplast SP430**



**Graph 1: Comparison of slump cone test**

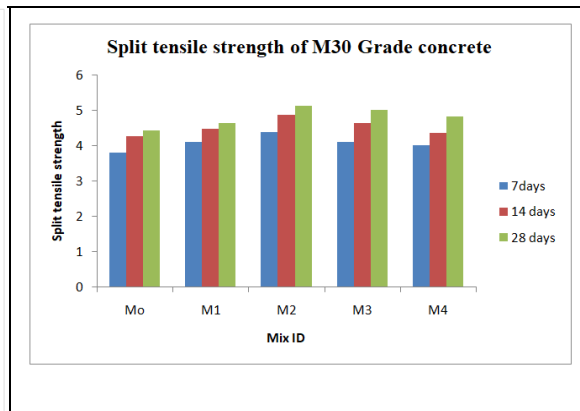
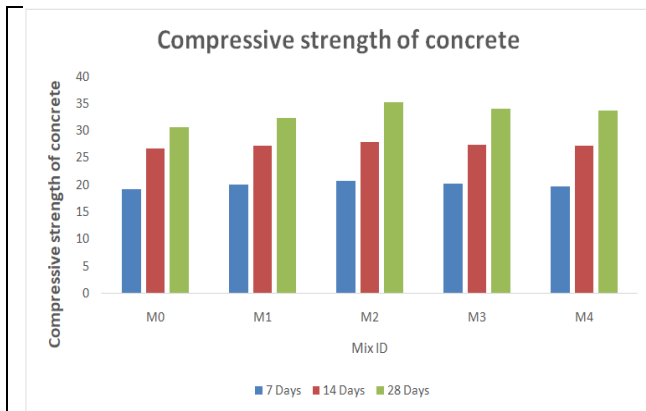


**Graph 2: Comparison of compaction factor**



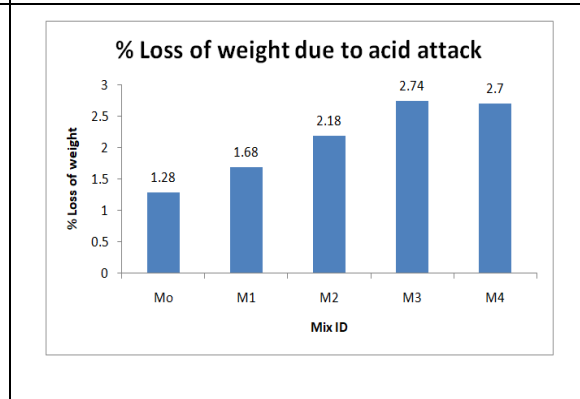
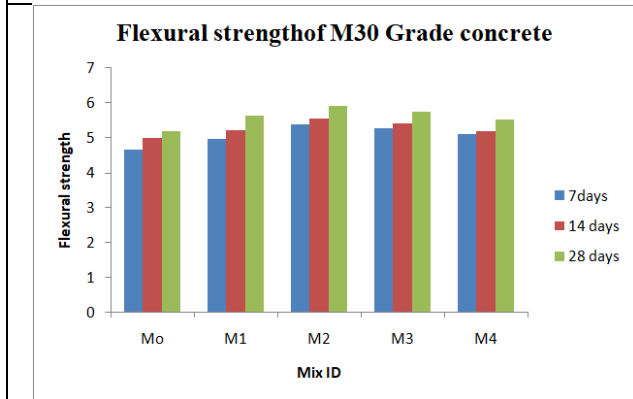


**Rex et al.,**



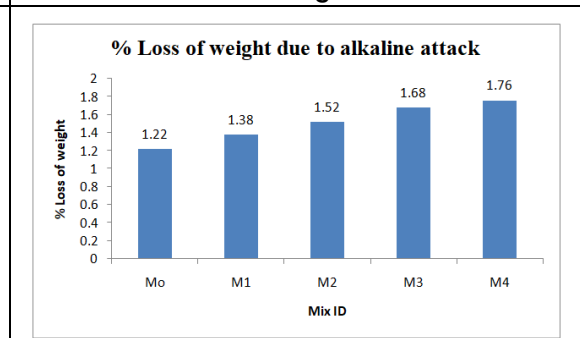
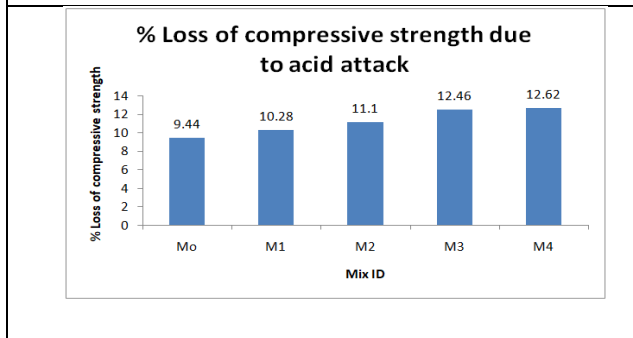
**Graph 3: Comparison of Compressive strength**

**Graph 4: Comparison of Tensile strength**



**Graph 5: Comparison of Flexural strength**

**Graph 6: Comparison of percentage loss of weight**



**Graph 7: Comparison of percentage loss of strength**

**Graph 8: Comparison of weight loss**





**Rex et al.,**

<p><b>% loss of compressive strength due to alkaline attack</b></p> <table border="1"><thead><tr><th>Mix ID</th><th>% Loss of Compressive strength</th></tr></thead><tbody><tr><td>Mo</td><td>10.44</td></tr><tr><td>M1</td><td>10.98</td></tr><tr><td>M2</td><td>11.32</td></tr><tr><td>M3</td><td>11.88</td></tr><tr><td>M4</td><td>12.4</td></tr></tbody></table>	Mix ID	% Loss of Compressive strength	Mo	10.44	M1	10.98	M2	11.32	M3	11.88	M4	12.4	<p><b>% loss of compressive strength due to sulphate attack</b></p> <table border="1"><thead><tr><th>Mix ID</th><th>% Loss of compressive strength</th></tr></thead><tbody><tr><td>Mo</td><td>18.82</td></tr><tr><td>M1</td><td>20.04</td></tr><tr><td>M2</td><td>21.84</td></tr><tr><td>M3</td><td>22.62</td></tr><tr><td>M4</td><td>23.8</td></tr></tbody></table>	Mix ID	% Loss of compressive strength	Mo	18.82	M1	20.04	M2	21.84	M3	22.62	M4	23.8
Mix ID	% Loss of Compressive strength																								
Mo	10.44																								
M1	10.98																								
M2	11.32																								
M3	11.88																								
M4	12.4																								
Mix ID	% Loss of compressive strength																								
Mo	18.82																								
M1	20.04																								
M2	21.84																								
M3	22.62																								
M4	23.8																								
<p><b>Graph 9: Comparison of percentage loss of strength</b></p>	<p><b>Graph 10: Comparison of percentage loss of strength</b></p>																								







## Analysis of Aerospace Application with Three Phases AC TO DC Converter and Sensor Network

B.S Inbasekaran<sup>1\*</sup> and P. Selvam<sup>2</sup>

<sup>1</sup>Research Scholar, Vinayaka Mission's Research Foundation (Deemed to be University), Salem, Tamil Nadu, India.

<sup>2</sup>Professor, Department of Electrical and Electronics Engineering, Vinayaka Mission's Kirupananda Variyar Engineering College, Vinayaka Mission's Research Foundation (Deemed to be University) Salem, Tamil Nadu, India.

Received: 30 Oct 2021

Revised: 15 Dec 2021

Accepted: 12 Jan 2022

### \*Address for Correspondence

**B.S Inbasekaran**

Research Scholar,

Vinayaka Mission's Research Foundation (Deemed to be University),

Salem, Tamil Nadu, India.



This is an Open Access Journal / article distributed under the terms of the **Creative Commons Attribution License** (CC BY-NC-ND 3.0) which permits unrestricted use, distribution, and reproduction in any medium, provided the original work is properly cited. All rights reserved.

### ABSTRACT

Low-voltage/ultra-low-voltage circuit approaches are used extensively in modern sensor networks, CPUs, I/O circuits, and memories. However, the need for higher internal voltages in most systems on chip based on these low voltage approaches necessitates the need of a reliable DC/DC converter. Boost DC/DC converter circuits are commonly employed to create higher voltages than the available supply voltage, such as during non-volatile memory programming or in low-voltage switched-capacitor systems. The Internet of Things (IoT) has prompted the connection of a wide range of devices to the Internet, paving the way for the development of a wide range of smart and networked objects. However, there are still a number of practical issues to be resolved, one of which being power supply. As a result, many power converter topologies and power management approaches have been developed.

**Keywords:** Aircraft, Internet of Things (IoT), Power management Exchange data, Global network, sensor,

### INTRODUCTION

Many components of implantable medical devices, wearable smart devices, monitoring systems, and other systems use the Internet of Things (IoT). Although IoT devices are often powered by batteries, they can also be powered by energy harvesting technologies in a variety of low-power applications. Power converters must be built to offer the modest and distributed energy required by such IoT devices, regardless of the power sources (batteries or the environment). This review paper will first provide an overview of power consumption in IoT devices; second, it will discuss the most recent research and advances in the field of fully-integrated or embedded DC/DC converters, ranging from high-performance integrated charge pumps or embedded inductive boost converters for specific



**Inbasekaran and Selvam**

harvesting sources (temperature, solar, etc.) to novel DC/DC converters for multiple energy sources. One word sums up the Internet of Things (IoT): opportunity. IoT provides chances for firms to remodel themselves, enter new markets, and harness data to make more quick and powerful business decisions by connecting devices and data. Simultaneously, it provides consumers with new ways to enjoy exciting new user experiences and conveniences. This paper examines IoT potential in the commercial aviation industry, as well as what providers can do to capitalise on them. Commercial aviation includes transportation, commercial aviation, freight, sport, and private aviation, as well as autonomous unmanned aircraft in the future. This multi-owner, multi-tenant situation makes implementing system-of-system efficiency and taking advantage of data inside developing IoT concepts extremely difficult. Despite the fact that economic aviation is conservative,

**Internet of Things challenges**

The web of Things difficulties will grow in tandem with the number of real-time applications (devices) that demand smart connections among themselves.

**Smart connectivity**

Sensors and devices that are connected and communicated together through the net of Things infrastructure may have to update their trends or feature to be suited to the changes of surrounding environments. The net of Things could be a smart infrastructure that may process the collected data and make the specified decisions to enhance itself and to vary the trends or features of the connected devices to accommodate the encompassing environments' changes. Internet of Things could be a smart technology that helps all connected devices to update themselves in step with changes within the surrounding environment and to be able to be adopted and add the other strange environment with high accuracy. Sensors and gadgets connected and communicating via the internet of things infrastructure may need to update their trends or features to keep up with changes in their surroundings. The Internet of Things (IoT) could be a smart infrastructure that can process collected data and make specific decisions to improve itself and change the trends or features of connected devices to adapt changes in the surrounding environment. The Internet of Things (IoT) could be a smart technology that allows all connected objects to update themselves in response to changes in their environment, allowing them to be adopted and added to new environments with great accuracy. As a result, smart linked systems may be created if smart infrastructure makes it simple to properly treat the data obtained from devices and make the necessary decisions.

**Literature Survey**

Maintaining the highest levels of privacy and security for all linked devices. The main idea of using the net of Things is to own a sensible system and to attach billions of devices over the entire world. The expected devices to be connected together are expected to be 60 billion through the net of Things devices by 2025. Figure 1 shows the expansion of the globe population and therefore the connected devices by 2025. Connecting such a large number of devices required high-security levels to forestall scams and to permit high level of knowledge protection. As a result achieving high level of security may be a big challenge to induce the needed trust from both industries and individuals to share their data utilizing the net of Things.

The fundamental goal behind adopting the Internet of Things is to have a logical structure and connect billions of devices all around the world. By 2025, the number of devices connected through the Internet of Things is estimated to reach 60 billion. Figure 1 depicts the growth of the global population and, as a result, the number of connected devices by 2025. To avoid frauds and provide a high level of knowledge protection, connecting such a huge number of devices necessitated high-security standards. As a result, attaining a high level of security could be a significant issue in gaining the necessary trust from both industries and individuals to share data via the Internet of Things. The following are the most significant drawbacks of AC-DC-AC converters or DC link converters: (1) they are unsuitable for transient operations because the voltage across the huge capacitor or inductor within the circuit cannot be altered instantaneously [2]; (2) they are bulky, heavier, and more expensive. Direct AC-AC converters such as cyclo converters and matrix converters [2, 3] overcome these limitations. The matrix converter [4, 5] is the subject of this



**Inbasekaran and Selvam**

chapter, and it has a specific use in aerospace. The matrix converter [6] is preferred for cyclo converters because it has no restrictions on acquiring output frequency. The rationale is that the output frequency of a cyclo converter can only be one-third of its input frequency. More Electric Aircraft (MEA) aims to promote green technology by replacing other aircraft power sources with electric power. An IoT device is a device of any size that is capable of at least communicating with networks and completing a task. It consists of a printed circuit, a microchip, a transmitter, and a receiver, and it may be used to operate and monitor systems through a smartphone [5]. The use of IoT technology in industries has brought the world closer to building a dream home powered by the most efficient system possible [6]. IoT is currently being used in a variety of additional applications, including as green houses, smart grids, buildings, and forming a smart city with smart transit [7]. IoT devices are now being used in the medical area to create smart health monitoring, various fitness programmes, and to help detect ailments and to worry elders.

**Treating big data**

The most significant challenge of adopting the Internet of Things is the massive increase in the amount of data sent between linked devices. The primary three sources of information are (1) the database used in the business process; (2) human everyday activities such as email, Facebook, and weblogs; and (3) the connection of physical equipment such as cameras and microphones, as shown in Figure 1. It's worth noting that over the last two years, 90 percent of all information on the planet has been created. This makes it more difficult for web of Things infrastructure designers to keep up with the growing amount of data created.

**Proposed Methodology**

Sensor packages that track an engine's performance and collect data on vibration, fuel consumption, and performance last for years. This information allows the engine manufacturer to advise the carrier on corrective actions, usually during upkeep periods, and has been used to predict and optimise when maintenance is required by studying this information over a few years of operation. With the introduction of IoT, engine manufacturers have been able to take advantage of this data sooner, allowing for faster service as well as advising on operational adjustments, such as those that might result in fuel savings or other advantageous activities (for example, changing a landing sequence to place less stress on the engine).

**IOT Concepts within the Management and Operation of Individual Devices**

At the moment, this is usually handled by ensuring that none of the Internet-connected gadgets are connected to any of the flight systems or networks that are security sensitive. This method prevents hostile assaults from passing across from the web to safety-critical apps, ensuring the aircraft's security. However, given the entire goal of IoT is to release valuable device data by connecting devices to cloud-based services for exploitation, the provision of bandwidth for this data is vital for this opportunity to be realised. Sensors, which are an essential component of any measuring system, are susceptible to a variety of errors caused by fabrication methods, calibration schemes, operating conditions, and so on. Different types of sensors used in aerospace applications cannot afford to have such mistakes because the measurements are critical to the mission's success. Many error correction systems are based on sensor characteristics modelling and are extremely complex and non-flexible. Furthermore, these approaches are ineffective for online mistake repairs, which are critical in real-time systems. In such instances, Artificial Neural Networks (ANN) with appropriate learning algorithms appear to be good options. For error correction, the proposed Meta-cognitive Extreme Learning Machine (McELM) based ANN framework automatically captures the non-linear behaviour of sensors to external environmental disturbances such as temperature, structure vibration, and so on. To increase the ANN network's adaptability and stability, a clustering-based thresholding strategy was devised. Experimental data from pressure sensors used for absolute pressure measurement onboard Indian launch vehicles were used to assess the algorithm's performance. The suggested cognition-based technique constructs a less computationally complicated network with fewer training samples and a simpler hidden neuron layer for sensor error correction.



**Inbasekaran and Selvam**

The other could be a real-time dataset obtained during testing of a piezo-resistive MEMS pressure transducer used for base pressure sensing in launch vehicle telemetry systems. The aim is to get a well-compensated pressure measurement no matter the sensor output change thanks to the external disturbance. The inputs to the neural network and therefore the target values were normalized between '0' and '1'. Simulations were done in MATLAB R2020a environment. Mean Squared Error (MSE) was used as a blunder measure to assess the performance.

**Applications**

The other may be a real-time dataset collected during the testing of a piezo-resistive MEMS pressure transducer utilised in launch vehicle telemetry systems for base pressure sensing. The goal is to obtain a well-compensated pressure measurement regardless of sensor output variations caused by external disturbances. The neural network's inputs, and hence the target values, were normalised between '0' and '1'. In a MATLAB R2020a environment, simulations were carried out. The performance was evaluated using the Mean Squared Error (MSE) as a blunder metric. Artificial Intelligence (AI) has been around for a long time, dating back to antiquity, but it received a major boost during World War 2. Since then, it has encountered numerous hurdles and has been successful in resolving issues that have hampered its acceptance/adoption in various sectors. Some industries, such as those developing safety-critical engineering applications, have made more progress in incorporating AI into their solutions than others (for example, home service robots, software applications, and self-driving cars), which produce technologies that have become commonplace in society. System performance that either processes information at non-real time limitations or does not include human beings in the system is typical of non-critical engineering solutions. The latter necessitates a safety assurance and certification process to ensure that human lives are adequately safeguarded. The topology of the matrix converter is a direct AC-AC power converter. It is made up of a matrix of bi-directional switches that allow any input phase to be connected to any output phase. A three input, three output converter will, in most situations, be made up of a 'matrix' of nine bi-directional switches, hence the term 'matrix converter'. To achieve the desired output voltage, the devices' gating is varied. To decrease the system's line side switching harmonics, a tiny input filter is required.

**The Future Work**

From federated devices to linked devices to IMA to virtualized applications and operating systems running on open, commercial off-the-shelf architectures, devices have evolved dramatically over the last two decades. The appearance of fully autonomous machines that make judgments independently of their human operators will be the next phase in this evolution. This vision is already taking shape in the IoT world, with gadgets using sensor inputs and other external data sources to make judgments about how to clean up or adjust operating parameters for greater efficiency. However, until safety and security criteria have been proved on wing operations, its progress is limited.

**CONCLUSION**

There are currently opportunities for IoT technology to be deployed in the commercial aviation industry. These opportunities include opportunities to use real-time device data to produce integrated predictive maintenance and intelligence linked to advanced flight management and MRO systems, as well as opportunities to use real-time device data to produce integrated predictive maintenance and intelligence linked to advanced flight management and MRO systems. As laws are established to produce for safe operation alongside passenger-carrying aeroplanes, future autonomous technologies will present a fantastic possibility for brand spanking new market segments.

**REFERENCES**

1. P. Malcovati, C. Azeredo Leme, P. O Leary, F. Maloberti, and H. Baltes, Smart sensor interface with A/D conversion and programmable calibration, IEEEJ. Solid State Circuits, vol.29, no.8, pp.963-966, Aug.1994.
2. M. Yamada and K. Watanabe, "A capacitive pressure sensor interface using oversampling demodulation techniques," IEEE Trans. Instrum. Meas., vol. 46, no. 1, pp. 3-7, Feb. 1997.



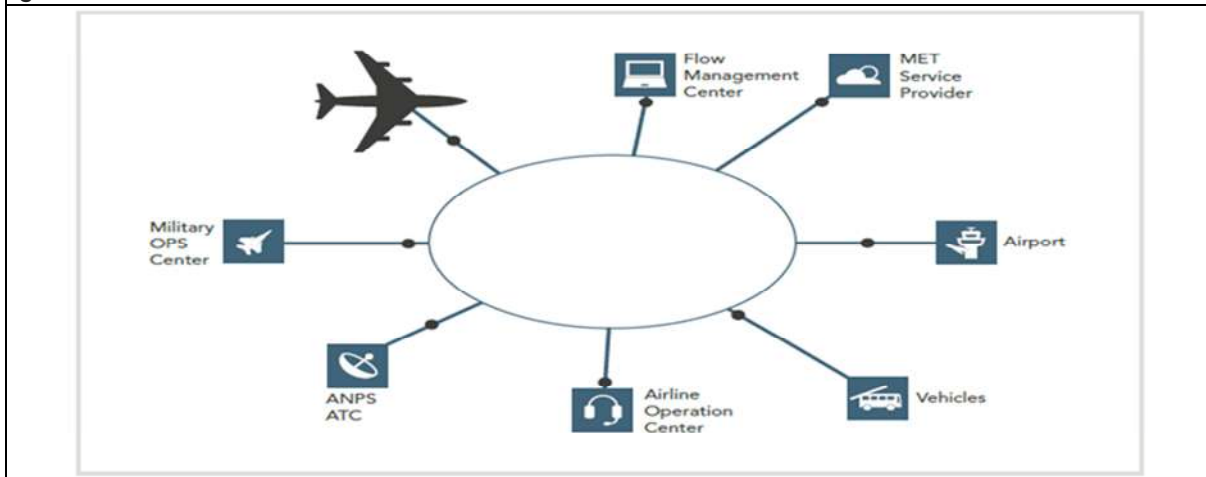


**Inbasekaran and Selvam**

3. S. Kaliyugavaradan, P. Sankaran, and V. G. K. Murthi, "A new compensation scheme for thermistors and its implementation for response linearization over a wide temperature range," IEEE Trans. Instrum. Meas., vol. 42, no. 5, pp. 952–956, Oct. 1993.
4. Vinitha Ramdas, Sethunadh.R, Saleem.H, Athuladevi.S, Valsa.B "A Novel Online Error Correction Scheme for Sensors in Aerospace Applications " Vikram Sarabhai Space Centre, Indian Space Research Organization, Trivandrum, India
5. R. Piyare and S.R. Lee, " Smart home-control and monitoring system using smart phone," The 1st International Conference on Convergence and its Applications, vol. 24, pp. 83-86, 2013.
6. Yang Lu, "Industry 4.0: A survey on technologies, applications and open research issues," Journal of Industrial Information Integration, vol. 6, pp. 1-10, 2017.
7. C.S. Shih, J.J. Chou, N. Reijers, and T.W. Kuo, "Designing CPS/IOT application for smart building and cities," IET Cyber- Physical Systems, vol. 1(1), pp. 3-12, 2016.
8. S.M.R. Islam, D. Kwak, M.H. Kabir, M. Hossain, and K.S. Kwak, " The Internet of Things for Healthcare: A comprehensive survey," IEEE Access, vol. 3, pp. 678-708, 2015.
9. A. Engler, R. De Maglie, R. Birost, F. Carraro, J. Engstler: "Multi-use 48kW DC/AC and AC/AC Power Electronic for unpressurized area", 5th CEAS Air & Space Conference, 7-11 Sept 2015, Delft, Netherlands.

Machine Sensors Data and Complex Data	Sensors, video Recording M2M Log files, Bioinformatics, Satellite Imaging	Human Enterprises content External Source	Weblogs Email Documents Social Activities
---	--	---	--

**Figure 1: Internet of Things (IoT) for Automated and Smart Applications Different sources of data growth**



**Figure 2: IOT Concepts in the Management and Operation of Individual Devices**





## Breast Cancer Prediction using Some Machine Learning Models by Dimensionality Reduction of Various Features

S Dhanalakshmi<sup>1\*</sup> and S. Thirunavukkarasu<sup>2</sup>

<sup>1</sup>Assitant Professor, Department of Mathematics, Faculty of Engineering and Technology, SRM IST, Ramapuram, Chennai - 600089, Tamil Nadu, India

<sup>2</sup>Assitant Professor, Department of Information Technology, Faculty of Engineering and Technology, BIHER, Chennai - 600073, Tamil Nadu, India

Received: 12 Nov 2021

Revised: 16 Dec 2021

Accepted: 11 Jan 2022

### \*Address for Correspondence

**S Dhanalakshmi**

Assitant Professor,  
Department of Mathematics,  
Faculty of Engineering and Technology,  
SRM IST, Ramapuram,  
Chennai - 600089, Tamil Nadu, India  
Email: dhanalas1@srmist.edu.in



This is an Open Access Journal / article distributed under the terms of the **Creative Commons Attribution License** (CC BY-NC-ND 3.0) which permits unrestricted use, distribution, and reproduction in any medium, provided the original work is properly cited. All rights reserved.

### ABSTRACT

Breast cancer is a disease that affects a large portion of the global population and is the world's second leading cause of death. At the same time, if detected early enough, it is one of the most treatable cancers. Early detection of breast cancer improves the prognosis and chances of survival by allowing patients to receive timely clinical treatment. Patients could avoid unneeded therapies if benign tumours were classified more precisely. Machine learning is a branch of artificial intelligence that use a variety of statistical, probabilistic, and optimization techniques to enable computers to "learn" from past examples and recognise difficult-to-find patterns in large, noisy, or complex data sets. In this work, we have used various supervised machine learning algorithms for predicting breast cancer problem. To improve the accuracy of those machine learning models from the existing one, we have used the PCA and LDA to reduce the dimensionality of the features, which helps to increase the efficiency of models with faster rate.

**Keywords:** Breast cancer, Machine learning, Dimensionality reduction, Supervised ML algorithms.





## INTRODUCTION

The proper diagnosis of important information is a crucial issue in the field of medical research. The medical planning officer's knowledge and skill in the medical profession is frequently used to diagnose the ailment. As a result, there are instances of inaccuracies, unintended biases and the requirement for a lengthy period of time for a precise diagnosis of sickness. Breast cancer is one of the most harmful and heterogeneous diseases in today's world, killing a large number of people all over the globe. Early detection and prognosis of a cancer type has become a necessity in cancer research since it can help with patient clinical treatment. Many research teams, both biomedical and -bioinformatics, have been drawn to the need of classifying cancer patients into high and low risk groups.[1,2]As a result, these methods have been used to model the progression and therapy of malignant diseases. Furthermore, the ability of machine learning algorithms to find essential features in complicated datasets demonstrates their value. Artificial Neural Networks (ANNs), Bayesian Networks (BNs), Support Vector Machines (SVMs), Decision Trees (DTs) are examples of these techniques. Even though it is clear that the application of machine learning algorithms can increase our understanding of cancer progression, adequate validation is required before these technologies can be used in clinical practice [3-5]. Lot of works have been carried out in diagnosing breast cancer with the help of machine learning techniques. Sun et al. presented a work on comparing feature selection approaches for unified breast cancer diagnosis in mammograms in 2005 [6]. Zheg et al. contributed his idea on a support vector machine (SVM) and a K-means algorithm for breast cancer diagnosis in 2014 [7]. Alireza Osarech and Bitu Shadgar analysed the SVM classification algorithm to obtain 98.80 percent and 96.63 percent accuracy on two separate benchmark datasets for breast cancer[8].Two datasets from the UCI depository were used to test the classification techniques. One dataset was used for illness identification (WBCD), and the other was used to predict recurrence [9]. While working on breast cancer prediction, S.Kharya proposed Artificial Neural Networks (ANN). The study emphasised the benefits of applying machine learning methods such as SVM, Naive Bayes, Neural Networks, and Decisive Analysis.[10]

### An Overview on Machine Learning

ML techniques often incorporate a learning process with the goal of learning to accomplish a task from "experience" (training data). In machine learning, data is made up of features, observations with labels. An individual example is usually described by a set of qualities, often known as features or variables, distinctive feature. The values can be nominal (enumeration), binary (i.e., 0 or 1), ordinal (e.g., A+ or B), or quantitative (integer, real). Machine Learning models and algorithms are evaluated using a variety of statistical and mathematical approaches. After completing the learning process our model performs the classification process based on training data. Also it will perform the prediction process associated with testing data.

### Task of Learning

We can classify the ML task depends up on the dataset or features whether supervised or unsupervised learning. If the given dataset contain labelled data which called as Supervised Learning otherwise called as unsupervised learning. In supervised learning, we have to provide the well labelled data to teach or train the machine, which means each data is already combined with correct output data. The supervised learning which are classified into classification and Regression. Unsupervised learning is the reverse of supervised learning that means doesn't use any labelled data to train the machine. There isn't any one data already combined with correct output data. The machine doesn't follow others guidance for determining the required output.

### Data Exploration and Cleaning

Remember that the quality of your inputs dictates the quality of your output. It makes reasonable to invest a large amount of time and attention to this step once you've finalised your company hypothesis. In my opinion, data research, cleaning, and preparation could take up to 70% of your total project time. The procedure for understanding, cleaning, and preparing your data for constructing a predictive model are outlined below:





### Variable Identification

Univariate Analysis  
Bi-variate Analysis  
Missing values treatment  
Outlier treatment  
Variable transformation  
Variable creation

In this paper, Jupiter Notebook tool has been used to implement the Breast Cancer dataset. To initiate, the following methods in Jupiter notebook are used to explore and clean data

### Data Visualization

A key component of a data scientist's job is data visualisation. Exploratory Data Analysis (EDA) is frequently used in the early stages of a project to obtain insight into your data. Using visuals to make things clearer and easier to grasp is quite beneficial, especially when dealing with massive, multidimensional datasets. It's critical to be able to present your findings at the end of your project. Because visualisation makes it simpler to spot patterns, trends, and outliers, as well as providing a clear, better, and more dependable result, it is used in this work by constructing a count plot, a pair plot, and a scatter plot. Data visualisation is done with the help of the seaborn library in this work

### Count Plot

```
ax=sns.countplot(df['diagnosis'],label="Count")
B,M=df['diagnosis'].value_counts()
print('Number of Benign', B)
print('Number of Malignant', M)
```

Number of Benign: 357  
Number of Malignant: 212

The above count plot graph clearly shows that the data set contains a greater number of benign (B) stage cancer tumours, which can be cured. Also displays there is less number of malignant (M) stage of cancer tumours in the dataset which is having minimum possibility to be cured. Diagnosis column of a dataset have shown that 357 are benign patients and 212 are malignant patients.

### Model Selection

Different categories of machine learning algorithm has been developed. Based on our dataset we have to choose the algorithm whether supervised or unsupervised. As our dataset has received labeled data here used supervised learning algorithms. Such classification algorithms are given as follows:

- Logistic Regression
- Decision Tree Classifier
- Naïve Bayes
- Random Forest Classifier

The following is how the data is set up for the model:

### Split data set

In the given dataset, first we splitting the data into feature dataset, which is known as independent data set (X), and a target data set which is known as dependent data set (Y). Here we are applying the python conditional operator for getting the independent feature of our dataset. Here assigned all the rows and columns whatever given in the breast cancer dataset except diagnosis of class label into X variable. Then assigned only diagnosis columns of dependent value into Y.







### Dhanalakshmi and Thirunavukkarasu

```
x=df.iloc[:,df.columns!='diagnosis'].values
y=df['diagnosis'].values
```

Split up of Independent and Dependent Variable

The train-test split procedure is used to measure the performance of machine learning algorithms that make predictions on data that was not used to train the model. The train-test split technique which are mainly used to evaluate the performance of a machine learning algorithm. It can be used for any supervised learning technique and can be utilised for classification or regression tasks. Here we have used scikit Python machine learning library to implement the train-test split evaluation procedure via the `train_test_split` function.

```
from sklearn.model_selection import train_test_split
X_train,X_test,Y_train,Y_test=train_test_split(x,y,test_size=0.25,random_state=42)
```

Splitting of 75% training set and 25% test set from DataFrame

#### Feature scaling

Feature scaling is a method of grouping the data's individual features into a range. During data pre-processing, it is utilised to handle dramatically shifting magnitudes, values, or units. A machine learning algorithm will presume larger values to be higher and smaller values to be lower if feature scaling is not done, regardless of the unit of measurement.

```
from sklearn.preprocessing import StandardScaler
sc=StandardScaler()
X_train=sc.fit_transform(X_train)
X_test=sc.transform(X_test)
```

Feature scaling

#### PCA and LDA

Principal Component Analysis is an unsupervised learning approach used in machine learning to reduce dimensionality. Feature scaling is a technique for grouping the data's independent features into a range. During data pre-processing, it's utilised to deal with magnitudes, values, and units that change significantly. A machine learning algorithm will presume that larger values are greater and smaller values are lower if feature scaling is not performed, regardless of the unit of measurement.

For example, a variable with a range of 0 to 100 will outperform a variable with a range of 0 to 1

The PCA algorithm is based on the following mathematical concepts:

- Variance and Covariance
- Eigenvalues and Eigen Factors

Linear discriminant analysis is supervised machine learning and it's a methodology for separating two or more classes of objects or events by finding a linear combination of features. Linear discriminant analysis, often known as LDA, separates numerous classes by computing the directions ("linear discriminants") that indicate the axis that improves separation. LDA is a technique for reducing dimensionality. As the name denotes dimensionality reduction techniques reduce the number of dimensions (i.e, variables or dimensions or features) in a dataset while withholding as much information as possible. The following machine learning codes of PCA and LDA has done dimensionality reduction for our breast cancer dataset. Here `sklearn.decomposition` and `sklearn.discriminant analysis` libraries has been used to import the PCA and LDA for dimensionality reduction from its features. By combining all the 31





### Dhanalakshmi and Thirunavukkarasu

features into a single feature without affecting the original value, we have used the above said analysis and its respective coding are shown below

```

from sklearn.decomposition import PCA
pca=PCA(n_components=1)
pca=PCA(0.9)
X_train=pca.fit_transform(X_train)
X_test=pca.transform(X_test)
explained_variance=pca.explained_variance_ratio_

from sklearn.discriminant_analysis import LinearDiscriminantAnalysis
lda=LinearDiscriminantAnalysis()
X_train=lda.fit_transform(X_train,Y_train)
X_test=lda.transform(X_test)
explained_variance=lda.explained_variance_ratio_
explained_variance

array([1.])

```

Dimensionality Reduction by using PCA and LDA

#### Create a function for tracking different models

A function is built to hold all of the models that were used to classify the data in the dataset. The sklearn package in Python is used to import all the methods of classification algorithms. Sklearn library is used to import all the models to get the training accuracy in a function. Then fitting operation has been applied in all the models to get high accuracy. LogisticRegression is used as a first model. Secondly K Neighbours Classifier method is used to get the accuracy by taking three arguments such as neighbors=5, metric='minkowski' and p=2. Next SVM algorithm has been used to analyse the output by SVC linear method of svm by considering two parameters such as kernel='linear', random state=0. Naïve Bayes Algorithm explored the accuracy using Gaussian NB model. To get accuracy state, Decision tree classifier tree class to use Decision Tree Algorithm and it gets two parameters as an argument such as criterion='entropy', random state=0. Finally RandomForestClassifier is imported through sklearn. Ensemble library. This model took one argument as estimators=100. It helps to improve decision tree accuracy by reducing over fitting. Then it is flexible to both classification and regression problems. We passed X\_train and Y\_train value to already defined function then received the accuracy by using the score method. Let us see the training accuracy associated with above mentioned models as given as follows

```
model=models(X_train,Y_train)
```

```

Logistic Regression Training Accuracy: 0.9694835680751174
KNeighbors Training Accuracy: 0.9624413145539906
Support Vector Machine (Linear Classifier) Training Accuracy: 0.9694835680751174
Gaussian Naive Bayes Training Accuracy: 0.9694835680751174
Decision Tree Classifier Training Accuracy: 1.0
RandomForest Classifier Training Accuracy: 1.0

```

#### Accuracies of training set model

The correctness of testing data is utilised to test the model. Imported the confusion matrix method of the metric class to check the accuracy. The confusion matrix shown the accuracy of a classifier by comparing the actual and predicted classes. Confusion matrix determines and gives about right and error values by classification model. The number of





### Dhanalakshmi and Thirunavukkarasu

right and inaccurate predictions is broken by class and summarised with count values. It reveals the types of errors made by the classifier as well as the errors themselves.

```

from sklearn.metrics import confusion_matrix
for i in range(len(model)):
    cm=confusion_matrix(Y_test, model[i].predict(X_test))

    TP=cm[1][1]
    TN=cm[0][0]
    FP=cm[0][1]
    FN=cm[1][0]

    print(cm)
    print('Model[{}] Testing Accuracy = "{}!"'.format(i, (TP+TN)/(TP+TN+FN+FP)))
    print()

[[86  3]
 [ 1 53]]
Model[0] Testing Accuracy = "0.972027972027972!"

[[87  2]
 [ 2 52]]
Model[1] Testing Accuracy = "0.972027972027972!"

[[86  3]
 [ 1 53]]
Model[2] Testing Accuracy = "0.972027972027972!"

[[86  3]
 [ 1 53]]
Model[3] Testing Accuracy = "0.972027972027972!"

[[86  3]
 [ 2 52]]
Model[4] Testing Accuracy = "0.965034965034965!"

[[86  3]
 [ 2 52]]
Model[5] Testing Accuracy = "0.965034965034965!"

```

#### Confusion matrix of test set

Above displayed the confusion matrix accuracy of each model. First four models has produced high accuracy when compared to rest of the model. That means given the low error value from the existing one. The remaining two models also produce the better accuracy. The accuracy details are given in the following topics over confusion matrix with heat map diagram.

#### Cross Validation

The two common difficulties in machine learning are over fitting and under fitting both of which affect the performance of machine learning models. The main goal of each machine learning model is to produce the best result. After dividing the training data from the dataset which will produce stable and detailed output. Hence, we will get the better outcome of our model based on the variation of over fitting and under fitting. To overcome the respective problem, we have to apply the cross validation. The K Fold Cross-Validation has been applied to divide the input dataset into K groups of samples of equal sizes. The prediction function uses k-1 folds for each learning set, while the rest of the folds are used for the test set. This strategy is often used in CVs. Since it is simple to grasp and produces less biased results than methods. The 10 fold cross validation to be used to validate the result in the model



**Dhanalakshmi and Thirunavukkarasu**

```
from sklearn.model_selection import cross_val_score
cross_validation0 = cross_val_score(model[0], X=X_train, y=Y_train, cv=10)
cross_validation1 = cross_val_score(model[1], X=X_train, y=Y_train, cv=10)
cross_validation2 = cross_val_score(model[2], X=X_train, y=Y_train, cv=10)
cross_validation3 = cross_val_score(model[3], X=X_train, y=Y_train, cv=10)
cross_validation4 = cross_val_score(model[4], X=X_train, y=Y_train, cv=10)
cross_validation5 = cross_val_score(model[5], X=X_train, y=Y_train, cv=10)

cross_validation0.mean(), cross_validation1.mean(), cross_validation2.mean(), cross_validation3.mean(), cross_validation4.
(0.9670542635658915,
 0.9600221483942415,
 0.9646733111849392,
 0.9693798449612403,
 0.9483388704318937,
 0.9483388704318937)
```

Cross validation result

## RESULT AND DISCUSSION

The following table is for different machine learning models with its accuracy in training set, testing set and their corresponding cross validation. Above table indicates, cross validation accuracy is balanced with the training set accuracy and testing set accuracy of first four models whereas the cross validation accuracy is imbalanced with training set accuracy of 100% as well as testing set accuracy of 96.59% in both the Decision Tree Classifier and Random Forest Classifier models.

## CONCLUSION

Breast cancer is the most common cause of mortality in women, and it is the only type of cancer that affects them worldwide. Several machine learning models have been developed for early identification and treatment of breast cancer, as well as to reduce the number of fatalities from the disease. Many breast cancer diagnosis approaches have been employed to improve diagnostic accuracy. This research looks at various supervised machine learning methods in order to find the most accurate model for breast cancer detection. This work aimed to improve predictive models using Python in order to improve accuracy in forecasting accurate outcomes. The examination of the results indicates that the combination of data, feature scaling and various classification methods and analyses create a highly effective tool for prediction. It is concluded from the previous work, our research contributes more accuracy with the help of PCA and LDA as discussed in the paper. Even though we arrived the optimal accuracy, the most exact model is required to improve classification techniques' performance and predict accuracy as close to 100% as it is most important to save the human life.

## REFERENCES

1. West, D., Mangiameli, P., Rampal, R., & West, V. (2005). Ensemble strategies for a medical diagnosis decision support system: A breast cancer diagnosis application. *European Journal of Operational Research* (162), 532–551
2. Barradcliffe, L.; Arandjelović, O.; Humphris, G. A pilot study of breast cancer patients: Can machine learning predict healthcare professionals' responses to patient emotions? In *Proceedings of the International Conference on Bioinformatics and Computational Biology*, Honolulu, HI, USA, 20–22 March 2017; pp. 101–106.



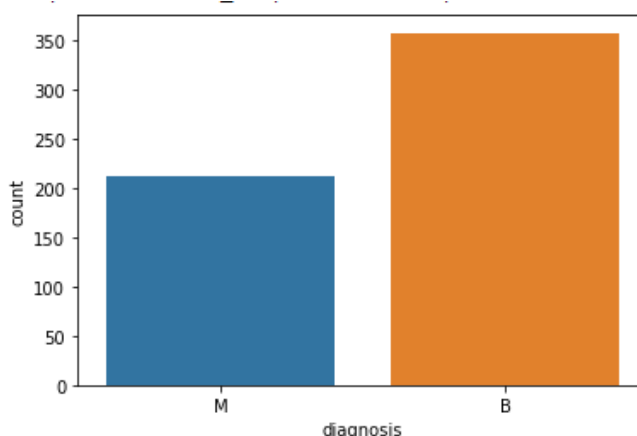


**Dhanalakshmi and Thirunavukkarasu**

3. A. J. Cruz and D. S. Wishart, "Applications of machine learning in cancer prediction and prognosis," Cancer Informatics, vol. 2, pp. 59–77, 2006.
4. M. F. Akay, "Support vector machines combined with feature selection for breast cancer diagnosis," Expert Systems with Applications, vol. 36, no. 2, pp. 3240–3247, 2009.
5. Sharma, A.; Kulshrestha, S.; Daniel, S. Machine learning approaches for breast cancer diagnosis and prognosis. In Proceedings of the International Conference on Soft Computing and Its Engineering Applications, Changa, India, 1–2 December 2017.
6. Y. Sun, C. F. Babbs, and E. J. Delp, "A comparison of feature selection methods for the detection of breast cancers in mammograms: adaptive sequential floating search vs. genetic algorithm," in Proceedings of the 2005 IEEE Engineering in Medicine and Biology 27th Annual Conference, pp. 6532–6535, Shanghai, China, September 2005.(15)
7. B. Zheng, S. W. Yoon, and S. S. Lam, "Breast cancer diagnosis based on feature extraction using a hybrid of K-means and support vector machine algorithms," Expert Systems with Applications, vol. 41, no. 4, pp. 1476–1482, 2014(17)
8. Alireza Osarech, Bitu Shadgar, "A Computer Aided Diagnosis System for Breast Cancer", International Journal of Computer Science Issues, Vol. 8, Issue 2, March 2011(21)
9. Mandeep Rana, Pooja Chandorkar and Alishiba Dsouza, "Breast cancer diagnosis and recurrence prediction using machine learning techniques", International Journal of Research in Engineering and Technology Volume 04, Issue 04, April 2015.(22)
10. D.Dubey, S.Kharya and S.Soni, "Predictive Machine Learning techniques for Breast Cancer Detection", International Journal of Computer Science and Information Technologies, Vol.4 (6), 2013, 1023-1028.

**Table 1. Comparison of Different Machine Learning Models Accuracy**

Machine Learning Models	Training Set Accuracy	Testing Set Accuracy	Cross Validation Accuracy
Logistic Regression	96.94%	97.20%	96.70%
KNeighbors Classifier	96.24%	97.20%	96%
Support Vector Machine	96.94%	97.20%	96.46%
Naïve-Bayes Classification	96.94%	97.20%	96.93%
Decision Tree Classifier	100%	96.59%	94.83%
Random Forest Classifier	100%	96.59%	94.83%



**Fig.1. Count plot for Malignant & Benign patients**





## Removal of Iron from Aqueous Media using Surface Modified Soya Hulls: Optimizing Batch Adsorption Conditions

Preeti Soni<sup>1</sup> and Shweta Vyas<sup>2\*</sup>

<sup>1</sup>Research Scholar, Department of Pure and Applied Chemistry, University of Kota, Kota, Rajasthan, India.

<sup>2</sup>Assistant Professor, Department of Pure and Applied Chemistry, University of Kota, Kota, Rajasthan, India.

Received: 13 Dec 2021

Revised: 24 Dec 2021

Accepted: 13 Jan 2022

### \*Address for Correspondence

**Preeti Soni**

Research Scholar,  
Department of Pure and Applied Chemistry,  
University of Kota,  
Kota, Rajasthan, India.  
Email: shwetavyas@uok.ac.in



This is an Open Access Journal / article distributed under the terms of the **Creative Commons Attribution License** (CC BY-NC-ND 3.0) which permits unrestricted use, distribution, and reproduction in any medium, provided the original work is properly cited. All rights reserved.

### ABSTRACT

Soybean hulls are waste product of soyabean processing industries, which are used as adsorbent in current study. Alkali treated soya hulls were modified with Oxalic acid and batch experiments were run as a capacity of solution pH (02-08), solution temperature (30 °C to 70°C), stirring time (20 min to 100 min), stirring speed (150 RPM to 450 RPM), Iron (Fe III) concentrations (20 ppm to 100 ppm), and adsorbent dose variations (1.5 g/l to 5.5g/l). The final concentrations of the Iron (Fe III) were determined by Atomic Absorption Spectrophotometer. The outcomes revealed that the adsorption effectiveness enhanced till the optimum conditions of stirring time (60 minutes), pH (06), adsorbent dosage (4.5g/l), solution temperature (50°C) and effluent concentration (80 ppm). The maximum removal percentage of Iron obtained at optimum conditions reached at 95.9% at maximum 17.10mg/g adsorbent capacity. These finding demonstrated that the Oxallic acid modified Soya-hulls (OMSH) are an alluring adsorbent for the effective removal of Iron (Fe III) from aqueous media in cost effective manner. Utilizing such waste material from industries can also be helpful to manage solid waste in sustainable development of environment.

**Keywords:** Iron Removal, Batch Adsorption, Modified Soyahulls, Solid-waste, Sustainable development.

### INTRODUCTION

A bit much release of industrial wastewater with heavy metals into environment has possible dangers to the flora, fauna and regular water framework. Among all reported methods for the removal of heavy metals, adsorption has been accepted as the most simple, economical and effective method for the wastewater treatment. The proficiency of

37817



**Preeti Soni and Shweta Vyas**

the adsorption cycle to eliminate the pollutant relies upon the adsorbent properties. Along these lines, the present study expected to identify the proficiency of modified Soybean hulls for the evacuation of Iron (Fe III) from the synthetic wastewater. In contrast to Organic pollutants which are mostly biodegraded, heavy metal ions do not degrade into innocuous end product and have a tendency to get accumulated[1]. The presence of hazardous heavy metal ions is of significant worry because of their lethal behaviour to numerous living things. Heavy metal defilement exists in aqueous waste of numerous industries, like tanneries, metal plating, refining, textile industries and cement manufacturing industries [2]. The noxious heavy metals like Mercury (Hg), Arsenic (As), Lead (Pb), Zinc (Zn), Iron (Fe), Nickel (Ni), Copper (Cu) etc. discover their ways to the water bodies through wastewater. [3]. Processes for heavy metal removal from industrial wastewater incorporate ion exchange adsorption, adsorption, precipitation, co-precipitation, membrane filtration etc. Studies on the treatment of wastewater having heavy metals have uncovered adsorption to be an exceptionally viable procedure for the removal of heavy metals from wastewater. For the removal of heavy metals from wastewater in recent years low cost agro wastes like potato peels [4]coconut squanders[5-7], Rice husk[8-12], Sugarcane bagasse [13-17] wheat straw[18-21] Banana peel [22] and so on and recently soyabean hulls have been utilized as an adsorbent[23-25].Cost is a significant parameter for selection of adsorbent materials, as it directly depends upon the local availability and ease of processing of adsorbent. As a thumb-rule, an adsorbent can be economical valuable, if it is abundant in nature or waste material of another industry and requires less processing [26-27]. Agrowastes may be considered among such materials, as these are the waste generated as by-products during the processing of commercially valuable products. Consequently there is a dire need that all potential sources of agro-waste based cheap adsorbents ought to be investigated and their attainability for removal of heavy metal ions ought to be concentrated exhaustively. Besides, the efficiency of the adsorption process is depended on large numbers of the factors, for example, contact time, pH and adsorbent dosage. The aim of this research is to contribute in the finding affinity for such low cost adsorbents and their exploitation possibilities for efficient removal of Iron from aqueous media. Herein, soya hull residues are used as low cost adsorbent for the purpose.

## MATERIALS AND METHODS

### Preparation of Adsorbent

Soybean Hull Residue (SHR) was taken locally from soya-oil producing vendor of Kota Rajasthan. These soybean hulls were washed several times to remove the dirt and impurities then dried. Then 10 g soybean hulls were treated with Sodium Hydroxide solution (NaOH) for 04 hours at 80°C [28-29], slurry washed with distilled water several times till neutral pH was gained and dried for 12 hours at 100°C in hot air oven to ground and sieved to get fine powder, which is further treated with 1.0 M oxalic acid in a 1:10 ratio, stirring at 300 RPM for 08 hours to get Oxalic acid modified soya-hulls residue (OMSH).The oxalic acid modified soybean hulls (OMSH) slurry was kept overnight at room temperature and filtered, washed till neutral pH, dried and kept in air tight vials to run batch adsorption processes.

### Reagents and Equipment

Atomic Absorption Spectrophotometer (AAS-ECIL4141 at wavelength 248.1nm), Sigma-Aldirch AAS Standard 1000 ppm solution of Iron (Fe). Standards for the calibration curves for AAS 20, 40, 60, 80 and 100 mg/l standard of Iron by diluting of the 1000 mg/l standard solution, Oxalic Acid (Extra pure, Merk scientific india), Doubly distilled DI water. Temperature control and shaking were performed by heating mantle with magnetic stirrer (Remi). A pH meter (Henna-pocket pH meter) was used to determine the pH of the solutions using NaOH and HNO<sub>3</sub> (0.1 mol/L) to adjust the solution pH.

### Batch Experiments

The batch experiments were conducted to study the adsorption capability of Oxalic acid modified soyahulls (OMSH) at different dosage, contact time, temperature, RPM speed, Iron concentration and pH. Then batch reactions [30] were carried out under various experimental conditions with continuous stirring to ensure homogenous mixing as



**Preeti Soni and Shweta Vyas**

shown in Table 1. The flask containing the sample was withdrawn at the desired time intervals and analysed by Atomic Absorption Spectrophotometer (ECIL-AAS, Wavelength 248.1) for residual Iron contents.

**RESULTS AND DISCUSSION****Effect of Temperature**

The impact of temperature on the removal of iron by modified soya bean hull (MSH) adsorbents was studied with in the temperature range of 30°C to 70 °C; as the temperature increased the adsorption efficiency of the adsorbent found to be increased which demonstrated that the reaction follows the endothermic pathway.

**Effect of Solution pH**

The impact of pH on the removal of iron by modified Soyabean hulls (MSH) adsorbents were studied as in Fig.4. The pH of the aqueous solution is a significant parameter in the adsorption process since it influences the solubility of the metal ions, concentration of the counter metal ions on the functional groups of the adsorbent. The pH of synthetic iron solution was differed from 02 to 08, Temperature 50 ° C, dosage of adsorbent is 4.5g/l, stirring time 60 minutes, stirring speed were kept at 300 rpm, and initial concentration 80 ppm respectively. From Fig.2 it's shown that as pH increases from 2 to 6, iron removal efficiency increases linearly. Subsequently, at low pH values (pH < 2) modified soyabean hulls showed exceptionally low tendency for removal of iron because of competition of H<sup>+</sup> with metal ions for binding sites. The optimum pH observed is at 6. Above pH >6 the removal efficiency bit by bit reduced, as iron get precipitate.

**Effect of Adsorbent Dosage**

The outcomes for adsorptive removal of synthetic iron solution with respect to adsorbent dose are displayed in Fig.3. The quantity of modified soyabean hulls varied from 1.5 g/l to 5.5g/l keeping all the other parameters constant throughout as initial concentration (80 ppm ), pH 6, and contact time 60 min. at 300 RPM It is shown that there is a constant increase in percentage removal of iron metal with increasing adsorbent dose. The maximum removal efficiency is seen at dosage of 4.5 g/l which may be expected due to more binding sites available at higher quantity of adsorbent.

**Effect of Iron Concentration**

The impact of initial concentrations on the removal of Iron (FeIII) on OMSH adsorbent was studied as shown in Fig.4. The fixed amount of adsorbent is added to 100ml of 20,40,60,80, and 100 ppm aqueous solution of Iron and pH of synthetic water was adjusted to pH6 with stirring (300 RPM) for 60 minutes at 50°C. It can be seen from the figure that as the initial metal ion concentration increases, the percentage removal efficiency increases till 80 ppm. At low initial concentrations, sufficient binding sites are available for adsorption of iron metal ions, at very high effluent concentration, as all the available binding sites for adsorption become exhausted and subsequently the percentage removal efficiency of heavy metal ions decreases.

**Effect of Stirring Speed**

The removal efficiency of the adsorbent was gradually increased reaching maximum up to 300 RPM. The increase in speed of stirring decreases the time needed for the adsorbate to equilibrate. In this study, stirring speed was varied from 150 to 450 RPM keeping all the other parameters constant. In Fig. 5, initially increase in the stirring speed enhanced the diffusion of the Iron towards the surface of the adsorbents as revealed by the increase in the percentage removal and reached at 300 RPM, after saturation no effect on further increment in stirring was observed.

**Effect of Contact Time**

The batch experiments were conducted at various contact times 20 to 100 min using magnetic stirrer at 300 RPM with keeping all other parameters constant at optimum conditions. The Percentage removal of Iron is shown in Fig. 6. The optimum time was at 60 minutes.







### Preeti Soni and Shweta Vyas

#### Data Analysis and Results

The synthetic water samples of Iron(Fe III) were prepared and agitated with adsorbent at different set of conditions and the sorption capacity (mg/g) and removal efficiency (% R) was calculated [31-32] using the following equation-

$$Q_e = \frac{(C_i - C_e)V}{m} \dots\dots\dots (1)$$

$$\% \text{Removal efficiency} = \frac{(C_i - C_e)}{C_i} \times 100 \dots\dots\dots (2)$$

Where  $Q_e$  is the maximum amount of Iron (Fe III) adsorbed on the OMSH (mg/g),  $C_i$  and  $C_e$  are the initial and final ion concentrations (mg/L) respectively,  $V$  is the volume of the medium used (L), and  $m$  is the amount of OMSH used (g). During this study,  $Q_e$  is calculated as 17.10 mg/g with 95.9% removal efficiency.

#### CONCLUSION

The present study reveals that soyahulls obtained from soyabean processing industries, after modification with Oxalic acid can be used successfully for the removal of Iron (Fe III) from aqueous media. Modification by Oxalic acid treatment significantly increased total negative charge on the surface of soyabean hull, which resulted into effective adsorption of Iron (Fe III). The maximum Iron (Fe III) removal efficiency was found to be 95.9% and maximum amount of Iron (Fe III) adsorbed on the OMSH was 17.10 mg/g. Future work is in progress for the establishment of suitable adsorption isotherms and to understand mechanism & kinetics of adsorption studies. As soyabean hulls are agro-waste materials, available worldwide in huge amount can be used as effective biosorbent for wastewater treatment.

#### ACKNOWLEDGEMENTS

Authors SV and PS are thankful to Science and Engineering Research Board, Department of Science and Technology, New Delhi for providing financial support under ASEAN-India Collaborative project scheme (IMRC/AISTDF/CRD/2018/0000062) of Govt. of India.

#### REFERENCES

1. Akpor, O. B. , "Heavy Metal Pollutants in Wastewater Effluents: Sources, Effects and Remediation." *Advances in Bioscience and Bioengineering*, 2(4), 37-43, 2014. <https://doi.org/10.11648/j.abb.20140204.11>
2. Hegazi, H. A., "Removal of heavy metals from wastewater using agricultural and industrial wastes as adsorbents." *HBRC Journal*, 9(3), 276–282 2013. <https://doi.org/10.1016/j.hbrj.2013.08.004>
3. Alalwan, H. A., Kadhom, M. A., & Alminshid, A. H., "Removal of heavy metals from wastewater using agricultural byproducts." *Journal of Water Supply: Research and Technology - AQUA*, 69(2), 99–112. 202. <https://doi.org/10.2166/aqua.2020.133>
4. Tariq, W., Saifullah, M., Anjum, T., Javed, M., Tayyab, N., & Shoukat, I. "Removal of Heavy Metals From Chemical Industrial Wastewater Using Agro Based Bio-Sorbents." *Acta Chemica Malaysia (ACMY)*, 2(2), 9–14., 2019. <https://doi.org/10.26480/acmy.02.2018.09.14>
5. Satsananan, C. "The Removal of Cd(II) by Using Local Materials for the Improvement of Quality of Life." *International Journal of Environmental Science and Development*, 8(3), 204–207, 2017 <https://doi.org/10.18178/ijesd.2017.8.3.948>
6. Johari, K., Saman, N., Song, S. T., Heng, J. Y. Y., & Mat, H., "Study of Hg(II) Removal From Aqueous Solution Using Lignocellulosic Coconut Fiber Biosorbents: Equilibrium and Kinetic Evaluation." *Chemical Engineering Communications*, 201(9), 1198–1220. (2014) <https://doi.org/10.1080/00986445.2013.806311>
7. Atikah, O. L., Pelawi, L. F., Wihelmina, B. V., Ibrahim, W. H., & Aribah, F. A. "The isolation of lignin from coconut fiber as bioadsorbent of Cr(III) in Lake of University of Indonesia." *ACM International Conference Proceeding Series, Iii*, 89–92. 2017. <https://doi.org/10.1145/3155077.3155086>
8. Chuah, T. G., Jumariah, A., Azni, I., Katayon, S., & Thomas Choong, S. Y. "Rice husk as a potentially low-cost





## Preeti Soni and Shweta Vyas

- biosorbent for heavy metal and dye removal: An overview." *Desalination*, 175(3), 305–316,2005. <https://doi.org/10.1016/j.desal.2004.10.014>
9. Nhapi, I, "Removal of Heavy Metals from Industrial Wastewater Using Rice Husks." *The Open Environmental Engineering Journal*, 4(1), 170–180,2011. <https://doi.org/10.2174/1874829501104010170>
  10. Asrari, E., Tavallali, H., & Hagshenas, M. "Removal of Zn (II) and Pb (II) ions using rice husk in food industrial wastewater." *Journal of Applied Sciences and Environmental Management*, 14(4), 159–162. 2010
  11. Agrafioti, E., Kalderis, D., & Diamadopoulos, E. "Arsenic and chromium removal from water using biochars derived from rice husk, organic solid wastes and sewage sludge." *Journal of Environmental Management*, 133, 309–314,2014. <https://doi.org/10.1016/j.jenvman.2013.12.007>
  12. Ajmal, M., Ali Khan Rao, R., Anwar, S., Ahmad, J., & Ahmad, R. "Adsorption studies on rice husk: Removal and recovery of Cd(II) from wastewater." *Bioresource Technology*, 86(2), 147–149, 2003. [https://doi.org/10.1016/S0960-8524\(02\)00159-1](https://doi.org/10.1016/S0960-8524(02)00159-1)
  13. Castillo, A., Nieva, A. D., & Caparanga, A. R., "Improved emulsion breaking for treatment of bilge water by induced-air flotation." AICHE 2012 - 2012 AICHE Annual Meeting, Conference Proceedings, April 2012.
  14. Van Tran, T., Bui, Q. T. P., Nguyen, T. D., Le, N. T. H., & Bach, L. G. "A comparative study on the removal efficiency of metal ions (Cu<sup>2+</sup>, Ni<sup>2+</sup>, and Pb<sup>2+</sup>) using sugarcane bagasse-derived ZnCl<sub>2</sub>-activated carbon by the response surface methodology." *Adsorption Science and Technology*, 35(1–2), 72–85. (2017) <https://doi.org/10.1177/0263617416669152>
  15. Pereira, F. V., Gurgel, L. V. A., & Gil, L. F. "Removal of Zn<sup>2+</sup> from aqueous single metal solutions and electroplating wastewater with wood sawdust and sugarcane bagasse modified with EDTA dianhydride (EDTAD)." *Journal of Hazardous Materials*, 176(1–3), 856–863, 2010. <https://doi.org/10.1016/j.jhazmat.2009.11.115>
  16. Sarker, T. C., Azam, S. M. G. G., El-Gawad, A. M. A., Gaglione, S. A., & Bonanomi, G. "Sugarcane bagasse: a potential low-cost biosorbent for the removal of hazardous materials." *Clean Technologies and Environmental Policy*, 19(10), 2343–2362,2017 <https://doi.org/10.1007/s10098-017-1429-7>
  17. Inyang, M., Gao, B., Pullammanappallil, P., Ding, W., & Zimmerman, A. R. "Biochar from anaerobically digested sugarcane bagasse." *Bioresource Technology*, 101(22), 8868–8872, 2010) <https://doi.org/10.1016/j.biortech.2010.06.088>
  18. Todorciuc, T., Bulgariu, L., & Popa, V. I. "Adsorption of cu(ii) from aqueous solution on wheat straw lignin: Equilibrium and kinetic studies." *Cellulose Chemistry and Technology*, 49(5–6), 439–447,2015.
  19. Parthasarathy, P., & Narayanan, S. K., "Effect of Hydrothermal Carbonization Reaction Parameters on." *Environmental Progress & Sustainable Energy*, 33(3), 676–680,2014. <https://doi.org/10.1002/ep>
  20. Amen, R., Yaseen, M., Mukhtar, A., Klemeš, J. J., Saqib, S., Ullah, S., Al-Sehemi, A. G., Rafiq, S., Babar, M., Fatt, C. L., Ibrahim, M., Asif, S., Qureshi, K. S., Akbar, M. M., & Bokhari, A. "Lead and cadmium removal from wastewater using eco-friendly biochar adsorbent derived from rice husk, wheat straw, and corncob." *Cleaner Engineering and Technology*, 1(May), 100006,2020. <https://doi.org/10.1016/j.clet.2020.100006>
  21. Shen, Z., Zhang, Y., McMillan, O., Jin, F., & Al-Tabbaa, A. "Characteristics and mechanisms of nickel adsorption on biochars produced from wheat straw pellets and rice husk." *Environmental Science and Pollution Research*, 24(14), 12809–12819,2017. <https://doi.org/10.1007/s11356-017-8847-2>
  22. Deshmukh, P. D., Khadse, G. K., Shinde, V. M., & Labhasetwar, P. , "Cadmium Removal from Aqueous Solutions Using Dried Banana Peels as An Adsorbent: Kinetics and Equilibrium Modeling." *Journal of Bioremediation & Biodegradation*, 08(03),2017. <https://doi.org/10.4172/2155-6199.1000395>
  23. Chandane, V., & Singh, V. K. "Adsorption of safranin dye from aqueous solutions using a low-cost agro-waste material soybean hull." *Desalination and Water Treatment*, 57(9), 4122–4134, 2016. <https://doi.org/10.1080/19443994.2014.991758>
  24. Canyon Hydro, Ferreres, X. R., Font, A. R., Ibrahim, A., Maximilien, N., Lumbroso, D., Hurford, A., Winpenny, J., Wade, S., Sataloff, R. T., Johns, M. M., Kost, K. M., State-of-the-art , *Intech*, 32(July), 137–144,2013.
  25. De Gisi, S., Lofrano, G., Grassi, M., & Notarnicola, M. "Characteristics and adsorption capacities of low-cost sorbents for wastewater treatment: A review." *Sustainable Materials and Technologies*, 9, 10–40, 2016. <https://doi.org/10.1016/j.susmat.2016.06.002>
  26. Panigrahi, T., & Santhoskumar, A. U. "Adsorption process for reducing heavy metals in Textile Industrial



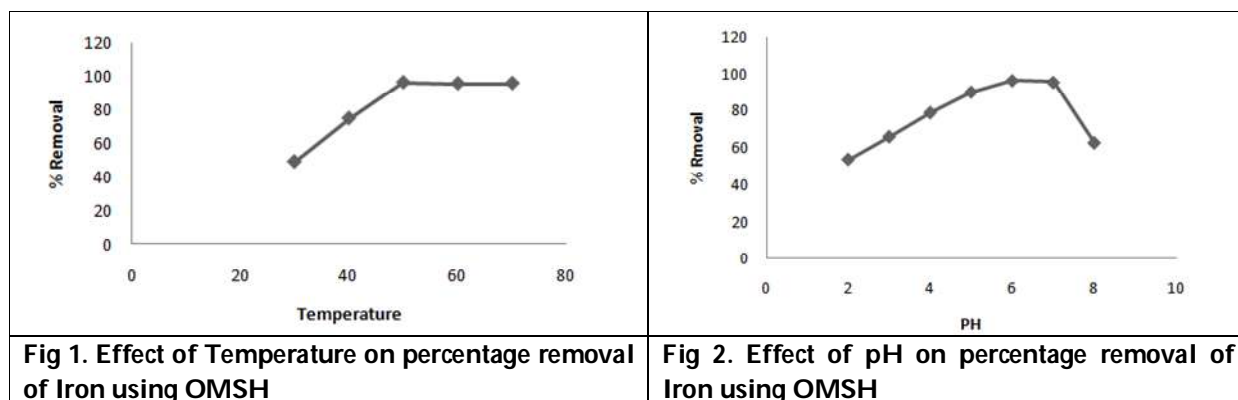


### Preeti Soni and Shweta Vyas

- Effluent with low cost adsorbents." *Progress in Chemical and Biochemical Research*, 3(2), 135–139,2020 <https://doi.org/10.33945/sami/pcbr.2020.2.7>
27. Inyang, M. I., Gao, B., Yao, Y., Xue, Y., Zimmerman, A., Mosa, A., Pullammanappallil, P., Ok, Y. S., & Cao, X. "A review of biochar as a low-cost adsorbent for aqueous heavy metal removal. *Critical Reviews in Environmental Science and Technology*, 46(4), 406–433" (2016), <https://doi.org/10.1080/10643389.2015.1096880>
  28. Daifullah, A. A. M., Girgis, B. S., & Gad, H. M. H. "Utilization of agro-residues (rice husk) in small waste water treatment plans." *Materials Letters*, 57(11), 1723–1731, 2003. [https://doi.org/10.1016/S0167-577X\(02\)01058-3](https://doi.org/10.1016/S0167-577X(02)01058-3)
  29. Altundogan, H. S., Arslan, N. E., & Tumen, F., "Copper removal from aqueous solutions by sugar beet pulp treated by NaOH and citric acid." *Journal of Hazardous Materials*, 149(2), 432–439, 2007. <https://doi.org/10.1016/j.jhazmat.2007.04.008>
  30. Krishnan, K. A., & Anirudhan, T. S. "Removal of cadmium(II) from aqueous solutions by steam-activated sulphurised carbon prepared from sugar-cane bagasse pith: Kinetics and equilibrium studies." *Water SA*, 29(2), 147–156, 2003. <https://doi.org/10.4314/wsa.v29i2.4849>
  31. Dang, V. B. H., Doan, H. D., Dang-Vu, T., & Lohi, A., "Equilibrium and kinetics of biosorption of cadmium(II) and copper(II) ions by wheat straw." *Bioresource Technology*, 100(1), 211–219,2009. <https://doi.org/10.1016/j.biortech.2008.05.031>
  32. Berhe Desta Mulu. "Batch Sorption Experiments: Langmuir and Freundlich Isotherm Studies for the Adsorption of Textile Metal Ions onto Teff Straw (Eragrostis tef) Agricultural Waste." *Journal of Thermodynamics*. <https://doi.org/Volume 2013, Article ID 375830, 6, 2013. http://dx.doi.org/10.1155/2013/375830>

**Table 1 Batch Reaction Conditions**

S.No.	Parameters	Units	Range
1	Iron Concentration	ppm	20-100
2	Adsorbent Dose	g/l	1.5-5.5
3	pH	-	2.0-8.0
4	Contact Time	Minutes	20–100
5	Stirring speed	RPM	150-450
6	Temperature	°C	30 °C-70°C





**Preeti Soni and Shweta Vyas**

<p><b>Fig 3. Effect of Adsorbent Dose on percentage removal Iron using OMSH</b></p>	<p><b>Fig 4. Effect of Initial Concentration on percentage removal Iron using OMSH</b></p>
<p><b>Fig.5. Effect of Stirring Speed on percentage removal of Fe using OMSH</b></p>	<p><b>Fig.6. Effect of Contact Time on percentage removal of Fe using OMSH</b></p>





## An Analytical Enquiry on the Impact of GDP and Capital on the Manufacturing Output in India: Evidence from ARDL Bounds Testing Approach

A. Sankaran\*

Assistant Professor, Department of Economics, School of Management, Pondicherry Central University, Pondicherry - 14, India.

Received: 08 Nov 2021

Revised: 14 Dec 2021

Accepted: 12 Jan 2022

### \*Address for Correspondence

**A. Sankaran**

Assistant Professor,  
Department of Economics, School of Management,  
Pondicherry Central University,  
Pondicherry - 14, India.



This is an Open Access Journal / article distributed under the terms of the **Creative Commons Attribution License** (CC BY-NC-ND 3.0) which permits unrestricted use, distribution, and reproduction in any medium, provided the original work is properly cited. All rights reserved.

### ABSTRACT

Industrial development plays a noteworthy role in all-walks of development. Within the industrial sector, manufacturing is a key component, which contributes meaningfully for the development of GDP, employment, export, and social change. In the Indian context, right from the second five-year plan, the manufacturing sector has been holding a substantial position in the overall development. As part of the developmental agenda, Indian government has introduced substantial policy changes through new economic reform in the overall economic frame in general and industrial sector in particular. Social Scientists such as Jeemol Unni, et., al.(2011), Rajakumar (2011), Pushpangadan, and Balakrishnan (2002), Chaudhuri (2002), Goldar (2002, 2015), Nagaraj (2003, 2017), Sunil Mani (2015) etc have extensively studied different dimension of the impact of the new economic policy in the industrial economy of India using different types of dataset and models. But estimating the long-run functional relationship among manufacturing output, capital and GDP, particularly in the post-reform period deserves for a separate research as this is an untapped research arena. Hence, the present study is an attempt to fill the gap existing in the literature by estimating the long-run relationship among the above mentioned variables. In order to pursue this research, secondary time-data for the reference period spanning from 1991- 2017 have been collected. The variables considered in the study are GDP, capital, and output. Among these variables, GDP data has been sourced from International Finance Statistics, published by International Monetary Fund. At the same time capital and output of manufacturing sector have been collected from ASI, published by Ministry of Statistics and Program Implementation, Government of India. The appropriate econometric models used for estimating the functional relationship among the variables revealed some interesting insights, which are pertinent for policy modelling.

**Keywords:** Manufacturing Output, Capital, Economic Reform, and ARDLJEL: L0, L6, & L69



**Sankaran****INTRODUCTION**

Industrial development is the *sine qua non* of the economic development and social change in a nation. A significant association between industrial development and economic growth was empirically demonstrated in a celebrated research work by Kaldor (1966). After his rigorous analysis of the interconnection between industrial growth and economic development in developed countries, Kaldor found a stylized fact that manufacturing sector performed as an engine of growth. Subsequently, studies by Crafts (1977); Bergier (1983); Pollard (1990); and von Tunzelman (1995) focused on the European countries such as France, Belgium and Switzerland and the result of the research validated Kaldor's model. Technology allows a nation to augment the volume of production, enhance the quality and cost per unit. The industrial development gives opportunity for the progress of disembodied and embodied technologies (Cornwall, 1977). The interconnection between industrial development and economic growth can be observed from the impact of former on latter. The existing evidence revealed that there is a significant correlation between rate of industrialization and increase in per capita income not only in developing countries, but also in developed countries. Further evidences uttered that the structural change bonus is the another important benefit from industrial development. Which denoted as immediate and higher level of productivity in industrial sector then that of agricultural sector as a result of the transfer of resources from primary sector to secondary sector. The reallocation of resources between these sectors is the major source of growth in developing and emerging nations (Lewis, 1954; Fei and Ranis, 1964; Chenery et al., 1986; Fagerberg and Verspagen, 1999; Timmer and Szirmai, 2000; Temple and Woessmann, 2006; Ark et al., 2003; Rodrik, 2009; and Timmer & de Vries, 2009). Moreover, the development of the manufacturing sector facilitates a nation to attain economies of scale, linkage and spillover effects, and benefit of expanding market.

**Literature Review**

The performance of industrial sector over the course of economic development has been scrutinized by economists in their academic publications. Among the available studies, leading economists of the nation such as Bhagwati & Desai (1970) and Rangarajan (1982) assessed the performance of the industrial sector during the plan period and the effect of the *permit license raj* on the manufacturing sector. By utilizing time series data on the total number of persons employed in manufacturing sector, Ghose (1994) Nagaraj (1994) Goldar (2000) Chandrasekhar (2003) Virmani (2007) and Das et al., (2009) measured the rate at which the manufacturing sector's generated employment. While the growth performance of the manufacturing economy of India was examined by many eminent economists such as Ahluwalia (1991), Bagchi, (1975), Ashok (1981), Chandrasekhar, (1988), Nagaraj (1990), Siddharthan, et., al (1994) Balakrishnan & Babu (2003), Chandrasekhar (1988), Chandrasekhar (2003) Bhat (2013) Goldar (2015) and Goyal (2015). Both total and partial factor productivities as suitable yardsticks to measure the performance of manufacturing economy, which was extensively applied by Banerji, (1975), Goldar (1983, 2015), Ahluwalia (1991), Chand, Satish & Kunal Sen (2002), Chand, et al., (2002), and Das & Deb Kusum (2003). Further the multi-dimensional assessment (including intra-sectoral transformation) in the industrial economy of India was examined by Srivastava (1986), Papola (1981), Thangamuthu (1973, 1983, 2004), Nagaraj (2003), Sankaran & Samantraya (2015) Sankaran & Rajkumar (2015) and very recently Sankaran et al., (2019). Hence, from the insights gained from these previous works, the present study attempted to estimate the long-run relationship among industrial output, capital and GDP by applying suitable econometric models during the post-reform period in the Indian context.

**Methodological Framework**

The present study is an empirical estimation to document long-run functional relationship among manufacturing output, capital and gross domestic product in one of the fastest-growing economy (India). To execute the study, we collected annual time series data for the period from 1991 to 2017. As mentioned, the study considered three pertinent variables such as manufacturing output, capital and GDP. Data on GDP has been collected from International Finance Statistics, published by the International Monetary Fund. At the same moment, data on capital and output of the manufacturing sector have been sourced from ASI, published by the Ministry of Statistics and Program Implementation, Government of India. Using Jeemol Unni, et., al.(2011), Rajakumar (2011), Pushpangadan, and Balakrishnan (2002), Chaudhuri (2002), Goldar (2002, 2015), Nagaraj (2003, 2017), and Sunil Mani (2015) studies,





### Sankaran

we have considered both fixed capital and working capital in our estimation. To normalize the variables, we converted them into natural log form. The stationarity condition of the variables directed us to apply the ARDL (Autoregressive Distributed Lag) bounds test of co-integration. Hence, to examine the functional relationship among the variables, we used the ARDL bounds test of co-integration. At the final stage, we incorporated the Toda-Yamamoto technique to find the causal relationship among the variables. The Autoregressive Distributed Lag model can be written as follows

$$LIO_t = \alpha + \sum_{i=1}^{n_1} \gamma LIO_{t-i} + \sum_{i=0}^{n_2} \beta_1 LGDP_{t-i} + \sum_{i=0}^{n_3} \beta_2 LPC_{t-i} + \sum_{i=0}^{n_4} \beta_3 LFC_{t-i} + \varepsilon_t \dots (1)$$

The error correction model specifying the short-run relationship among the variables

$$\Delta LIO_t = \alpha + \sum_{i=1}^{n_1} \gamma \Delta LIO_{t-i} + \sum_{i=0}^{n_2} \beta_1 \Delta LGDP_{t-i} + \sum_{i=0}^{n_3} \beta_2 \Delta LPC_{t-i} + \sum_{i=0}^{n_4} \beta_3 \Delta LFC_{t-i} + \varepsilon_t \dots (2)$$

## RESULT AND DISCUSSION

The industrial sector of India has travelled different episodes over the past few decades. To make the industrial sector very vibrant, invite foreign investors and attract the attention of global nations, the Indian government had introduced the new industrial policy in 1991 during then Prime Minister Mr **P. V. Narasimha Rao's** tenure. The component of new industrial policy was different folds: separate effort for macroeconomic stabilization, sectoral and structural adjustment programmes, a substantial reduction in tariff, the open-door system for the free flow of capital and managerial skills from foreign countries, abolition of licensing, and reduction in government's holding of economic sectors etc. The impact of these unleashed industrial policies was assessed by many scholars. But there is no scientific assessment available in the literature for the recent period particularly to capture the underlying relationship among industrial output, capital and GDP. Hence the present study is an attempted to examine the functional relationship among the above-cited variables. At the initial stage of the analysis, we checked the stationarity condition of the time series variables, for that we have applied both ADF and PP tests. The results obtained from these two estimations illustrates that all variables are a mix of  $I(0)$  and  $I(1)$ . The condition of the dataset permitted us to apply the ARDL model. The F statistics has been computed under the ARDL model to identify the co-integration. It is visible from the estimated result that the value lies above the upper-bound critical limit. Hence, it can be interpreted as the considered variables are cointegrated over the period.

The estimated results of diagnostic tests demonstrate clearly that the model is not suffering from the problems of non-normality of the error term, misspecification issues, serial correlation and heteroscedasticity as indicated respectively by results of Ramsey rest test, JB test, LM and ARCH tests (as indicated in Table: 6). At the same time, the results of Jarque-Bera reinforced the results that the residuals are not affected by the above-mentioned problems. Further, to check the robustness/stability of the model, we prepared the CUSUM and CUSUMSQ plots advanced by Pesaran and Pesaran (1997). When the plots lie between the 5% critical bounds, it can be interpreted as the estimated coefficients are stable. Further, it can be illustrated from the Figures that the critical values (blue lines) never exceed the boundaries (red lines) and they are positive implying that the dependent and independent variables are positively associated over the period. While one co-integrating vector found in the estimation, Johansen and Juselius (1990) technique for co-integration should not be applied. Under, such a circumstance, it is imperative to apply Pesaran and Shin (1995) and Pesaran et al., (1996) proposed Autoregressive Distributed Lag (ARDL) model. The result for the long-run relationship among the endogenous and exogenous variable (GDP) is significant at 1% level. This result proves that the long-run effect of economic growth on industrial output in the fastest-growing India. Structural changes as a result of India's sustained growth are likely to brought industrial growth. Further, this insight reveals that the **Kaldor's** (1966) world-famous first law (increase in manufacturing output positively influences the economic growth) revised in the case of India. While other variables such as productive capital, and fixed capital are influencing the manufacturing output at 5% level of significance. This result gains support from the world-famous financial-led growth theory propounded by **Schumpeter** (1911). The supply leading supposition, a part of Patrick hypothesis, is also relevant in this context.





### Sankaran

The short-run coefficient and the value of error correction term available in the Table: 3 reveal an interesting story that quite expectedly the value of error correction term is negative and significant (-0.56, 0.01). Hence, it is illustrated from the co-efficient of error correction term that the whole system can get back to the long-run equilibrium at the speed of 56 per cent per year. In line with Banerjee et. al., (2003) cited in Kidanemariam's (2014) work that negative error correction term with higher significant value reinforces the fact that there exists a stable long-run relationship. Further, it can be mentioned as the co-efficient is highly significant due to the value of t statistics is very high (4.58). The causal relationship among the manufacturing output, capital utilized in the manufacturing economy and real GDP have been detected by the Toda-Yamamoto causality test. The result of the experiment presented in Table: 7 illustrates that the unidirectional causality flowing from GDP to industrial output for the study period, supporting the *conservative hypothesis* over the study period. This result guides that the national income of India should be augmented to enhance the industrial economy of the nation. Further, the fixed capital accumulated in the industrial sector is positively affecting the GDP. Fixed capital is the money invested in fixed assets such as properties, plant, vehicles, buildings, types of equipment, installations and physical infrastructures, types of machinery etc. These are tangible and durable; the overall economic development of a nation is also largely realized with the support of these variables. Similarly, both GDP and fixed capital granger cause productive capital. As the productive capital is the totality of both working capital and fixed capital, the escalation of causality from fixed capital to productive capital is a common phenomenon. But interestingly GDP granger causes productive capital, testifying the stylized fact that economic development facilitates for capital accumulation in the manufacturing economy of India.

## CONCLUSION AND POLICY IMPLICATIONS

Industrial development is inherently interconnected with the sustainable socio-economic development of a nation. The existing pieces of evidence put forward by a leading economist of the world demonstrated the presence of long-term causality escalating from the development of the industrial sector to overall economic development. Against this backdrop, the present study empirically investigates the underlying relationship between manufacturing output, GDP, and capital. In order to execute this research, we used secondary data for the period from 1991 to 2018, for the above-mentioned variables, which are sourced from the World Development Indicators, International Finance Statistics, Handbook of Statistics on Indian Economy and Annual Survey of Industries. As the variables are the combinations of  $I(0)$  and  $I(1)$  we used the ARDL test. ARDL bounds: The result of the experiment revealed that the variables are co-integrated, and are not suffering from the problems of serial correlation and heteroscedasticity. Further, the behavior of CUSUM and CUSUMSQ plots testified that the model is stable. The long-run coefficient of GDP on industrial output is positive and significant at 1% level conforms the reversal of the world-famous Kaldor's first law with the Indian context over the study period. The long-run impact of GDP on industrial output is further reinforced by the Toda-Yamamoto causality result. Achieving the industry-led growth potential requires a shift of unregistered manufacturing activity to the registered sector, in turn it requires labour market reforms. Further, increase in labour productivity can be achieved if and only the sufficient amount of investment is earmarked. The capital bias towards industries will hamper industrialization and lead to wastage of young labour force as they are yet to be absorbed in the industrialized sector. We have to make use of our comparative advantage in labour. Further evidence for Schumpeter-led growth hypothesis and Patrick hypothesis gives the possibility of finance-led innovation and growth regime in India. The situation may further be turned better off if further penetration of financial system takes place. The government should bring in long term policy perspectives, which augment industrial production through the financial system and striving for structural changes.

## REFERENCES

1. Ashok, D. V. (1981). Factors Underlying the Slow Growth of Indian Industry. *Economic and Political Weekly*, 16(12), 381- 392.
2. Bagchi, A. K. (1975). Some Characteristics of Industrial Growth in India. *Economic and Political Weekly*, 10(7), 157- 164.
3. Balakrishnan, P, & Suresh Babu, M. (2003). Growth and Distribution in Indian Industries in the Nineties. *Economic and Political Weekly*, 38(8), 3997-4005.







### Sankaran

4. Banerji, A. (1975). *Capital Intensity and Productivity in Indian Industry*, Mac Millan, New Delhi.
5. Bhagwati & Desai. (1970). *Planning for industrialization, India's Trade and industrialization policy*, Oxford University Press, New Delhi.
6. Bergier, J.F. (1983). *Die Wirtschaftsgeschichte der Schweiz: Von den Anfängen bis zur Gegenwart*. Benziger Verlag.
7. Chandrasekhar, C. P. (1988). Aspects of growth and structural change in Indian industry. *Economic and Political Weekly*, 23(45&47), 2359-2370.
8. Chand, S., & Sen, K. (2002). Trade liberalization and productivity growth: evidence from Indian manufacturing. *Review of Development Economics*, 6(1), 120-132.
9. Chandrasekhar, C. P. (2003). Neo-Liberal Reform and Industrial Growth: Towards Revival or Recession. *Social Scientist*, 31(11/12), 3-22.
10. Cornwall, J. (1982). *Modern capitalism: its growth and transformation*. Routledge.
11. Crafts, N. F. (1977). Industrial Revolution in England and France: some thoughts on the question: Why was England first?. *The Economic History Review*, 30(3), 429-441.
12. Das, D. K. (2004). Manufacturing productivity under varying trade regimes, 1980-2000. *Economic and Political Weekly*, 39(5), 423-433.
13. Das, Deb Kusum, Deepika Wadhwa, & Gunajit Kalita, (2009). Employment Potential of Labour Intensive Industries in India's Organized Manufacturing. ICRIER Working Paper No. 236.
14. Engel, E. (1857). Die Produktions- und Consumptions Verhältnisse des Königreichs Sachsen, Zeitschrift des Statistischen Bureaus des Königlich Sächsischen Ministeriums des Innern, November.
15. Fagerberg, J., & Verspagen, B. (1999). 'Modern Capitalism' in the 1970s and 1980s. In *Growth, employment and inflation* (pp. 113-126). Palgrave Macmillan, London.
16. Fei, J.C.H., & Ranis, G. (1964). *Development of the Labor Surplus Economy. Theory and Policy*. Irwin, Homewood, IL.
17. Ghose, A. K. (1994). Employment in Organized Manufacturing in India. *Indian Journal of Labour Economics*, 37(2), 141-62.
18. Goldar, B. (2000). Employment Growth in Organized Manufacturing in India. *Economic and Political Weekly*, 35(14), 1191-1195.
19. Goldar, B. (2015). Growth in Gross Value Added of Indian Manufacturing: 2011–12 Series vs 2004–05 Series. *Economic and Political Weekly*, 12(21), 10-13.
20. Judith A. Davey. (1970), *Transactions of the Institute of British Geographers*, No. 49, 183-199.
21. Kaldor, N. (1966). Causes of the slow rate of growth of the United Kingdom: an inaugural lecture, in N. Kaldor (1978), *Further Essays on Applied Economics*, Duckworth, London.
22. Lewis, W. A. (1954). Economic development with unlimited supplies of labour. *The manchester school*, 22(2), 139-191.
23. Nagaraj, R. (1990). Industrial Growth: Further Evidence and towards an Explanation and Issues. *Economic and Political Weekly*, 25(41), 2310-2332.
24. Nagaraj, R. (1994). Employment and Wages in Manufacturing Industries: Trends, Hypothesis and Evidence. *Economic and Political Weekly*, 32(52), 177-186.
25. Pollard, S. (1990). *Typology of Industrialization Processes in the Nineteenth Century*. Academic Publishers, Harwood.
26. Robinson, S., Syrquin, M., & World Bank. (1986). *Industrialization and growth: a comparative study*. New York: Published for the World Bank, Oxford University Press.
27. Rodrik, D. (2009). *Growth after the Crisis*. Harvard Kennedy School, Cambridge, MA.
28. Siddharthan, N S, B L Pandit & R N Agarwal. (1994). Growth and Profit Behaviour of Large Indian Firms. *The Developing Economies*, 32(2), 188-209.
29. Szirmai, A. (2012). Industrialization as an engine of growth in developing countries, 1950–2005. *Structural change and economic dynamics*, 23(4), 406-420.
30. Temple, J, & Woessmann, L. (2006). Dualism and cross-country growth regressions. *Journal of Economic Growth*, 11(3), 187–228.
31. Timmer, M.P, & Szirmai, A. (2000). Productivity in Asian manufacturing: the structural bonus hypothesis examined. *Structural Change and Economic Dynamics* 11(4), 371–392.





**Sankaran**

- 32. Timmer, M.P, & de Vries, G.J. (2009). Structural change and growth accelerations in Asia and Latin America: a new sectoral data set. *Clometrica* 3 (2), 165–190.
- 33. Van Ark, B, & M. P. Timmer (2003). Asia’s Productivity Performance and Potential: The Contribution of Sectors and Structural Change. Groningen: University of Groningen and the Conference Board.
- 34. Von Tunzelman, N. (1995). *Technology and Industrial Progress*. Edward Elgar, Cheltenham.

**Table No 1: Descriptive Statistics**

	LIO	LGDP	PC	LFC	LWC
Mean	19.0	17.4	18.4	18.1	16.9
Median	18.9	17.3	18.0	17.8	16.7
Maximum	20.5	18.9	19.8	19.6	18.1
Minimum	17.2	15.7	16.8	16.5	15.3
Std. Dev.	1.0	1.0	0.9	0.9	0.9
Skewness	0.0	0.0	0.2	0.3	0.1
Kurtosis	1.7	1.8	1.8	1.8	1.6
Jarque-Bera	2.0	1.6	1.9	1.8	2.2
Probability	0.4	0.5	0.4	0.4	0.3
Sum	513.1	469.1	495.8	488.8	455.6
Sum Sq. Dev.	28.4	24.9	21.6	22.3	19.9
Observations	27	27	27	27	27

**Table No 2: ARDL Bounds Test**

Test Statistic	Value	k
F-statistic	103.01***	3

\*\*\* indicates significant at 1% level, respectively.

**Table No 3: Co-integrating Form**

Variable	Coefficient	Std. Error	t-Statistic	Prob.
D(LIO(-1))	-0.73***	0.15	-5.02	0.01
D(LIO(-2))	-0.14	0.09	-1.69	0.17
D(LGDP)	1.38***	0.18	7.47	0.00
D(LGDP(-1))	-0.35	0.34	-1.03	0.36
D(LGDP(-2))	1.54***	0.37	4.14	0.01
D(LGDP(-3))	0.60**	0.22	2.70	0.05
D(PC)	-0.63***	0.15	-4.22	0.01
D(PC(-1))	1.80***	0.20	8.89	0.00
D(PC(-2))	0.70***	0.12	5.75	0.00
D(PC(-3))	0.53***	0.10	5.61	0.00
D(LFC)	0.50**	0.12	4.06	0.02
D(LFC(-1))	-2.23***	0.24	-9.27	0.00
D(LFC(-2))	-0.80***	0.11	-6.97	0.00
D(LFC(-3))	0.51***	0.09	5.66	0.00
CointEq(-1)	-0.56***	0.12	-4.58	0.01
R-squared		0.998		
Adjusted R-squared		0.992		





**Sankaran**

F-statistic	144.58		
Prob(F-statistic)	0.00		
Durbin-Watson stat	2.25		
** and *** indicates significant at 5% and 1% level, respectively.			

**Table No 4: Long Run Coefficients**

Variable	Coefficient	Std. Error	t-Statistic	Prob.
LGDP	1.98***	0.22	8.86	0.00
PC	-8.68**	2.42	-3.59	0.02
LFC	7.53**	2.13	3.53	0.02
C	6.38**	1.76	3.63	0.02
** and *** indicates significant at 5% and 1% level, respectively.				

**Table No 5: Long Run Coefficients**

Variable	Coefficient	Std. Error	t-Statistic	Prob.
LGDP	1.98***	0.22	8.86	0.00
PC	-8.68**	2.42	-3.59	0.02
LFC	7.53**	2.13	3.53	0.02
C	6.38**	1.76	3.63	0.02
** and *** indicates significant at 5% and 1% level, respectively.				

**Table No 6: Diagnostic Check**

Ramsey Reset Test	LM test	Jarque -Bera test	ARCH test
0.49(0.53)	0.60(0.62)	0.35(0.17)	0.41(0.52)

**Table No 7: Toda- Yamamoto Causality Test**

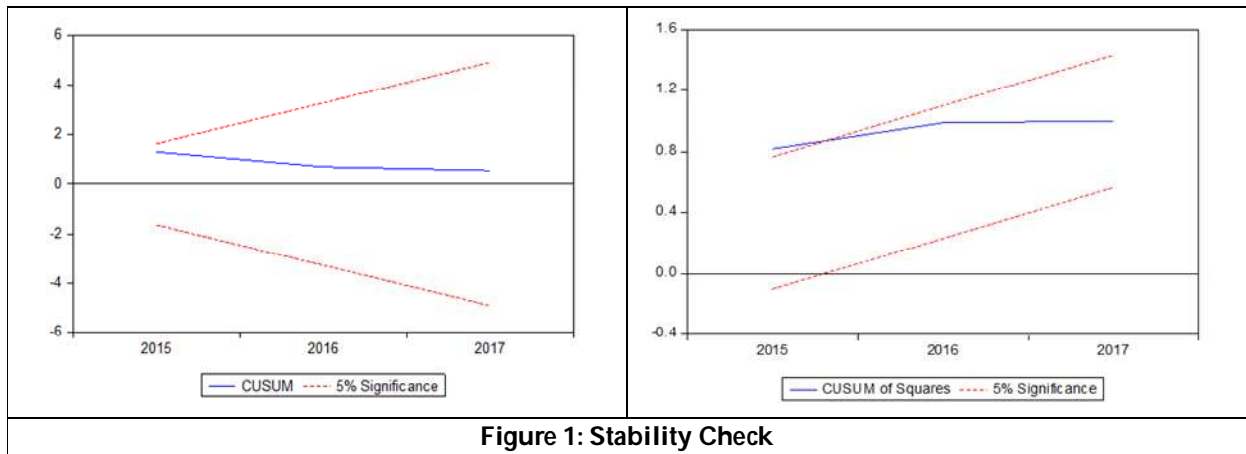
Dependent variable: LIO			
Excluded	Chi-sq	df	Prob.
LGDP	15.64***	2	0.00
PC	2.05	2	0.36
FC	3.79	2	0.15
Dependent variable: LGDP			
Excluded	Chi-sq	df	Prob.
LIO	2.25	2	0.33
PC	1.64	2	0.44
FC	6.03**	2	0.05
Dependent variable: PC			
Excluded	Chi-sq	df	Prob.
LIO	5.07*	2	0.08
LGDP	9.22***	2	0.01
FC	11.48***	2	0.00

\*, \*\* and \*\*\* indicates significant at 10%, 5% and 1% level, respectively.





**Sankaran**



**Figure 1: Stability Check**





## Interval Valued Fuzzy S – Hausdorff Space

D. Bhavani Gokila<sup>1\*</sup> and V.M.Vijayalakshmi<sup>2</sup>

<sup>1</sup>Research Scholar, Department of Mathematics, Avinashilingam Institute for Home Science and Higher Education for Women, Coimbatore, Tamil Nadu, India.

<sup>2</sup>Assistant Professor, Department of Science and Humanities, School of Engineering, Avinashilingam Institute for Home Science and Higher Education for Women, Coimbatore, India.

Received: 15 Dec 2021

Revised: 24 Dec 2021

Accepted: 17 Jan 2022

### \*Address for Correspondence

#### Bhavani Gokila

Research Scholar,

Department of Mathematics,

Avinashilingam Institute for Home Science and Higher Education for Women,

Coimbatore, Tamil Nadu, India

Email: bhavanigokila@gmail.com



This is an Open Access Journal / article distributed under the terms of the **Creative Commons Attribution License** (CC BY-NC-ND 3.0) which permits unrestricted use, distribution, and reproduction in any medium, provided the original work is properly cited. All rights reserved.

### ABSTRACT

The idea of IVF S-Hausdorff space is investigated by expanding the definite on of fuzzy Hausdorff space of Srivatsava [10].

**Keywords:** Fuzzy set, IVF set, fuzzy point, IVF point, IVF topology, IVF subspace topology, IVF product topology, IVF S-Hausdorff space. ("Note: interval valued fuzzy set as IVF")

## INTRODUCTION

In order to enact with respective complex situations with unreliabilities in many branches of different fields are observed to be deficient. In 1965, Zadeh [15] proposed fuzzy set theory which assisted to grip unreliability and impression. In 1975, Zadeh [16] build an addition referring to the conceptualization of a fuzzy set next to an IVF set in the company of an IV membership function. Mondal and Samantha [11] established the topology of IVF sets and considered a few of its belongings. In second session of this work, preparatory definitions in connection with fuzzy set, fuzzy point, IVF sets, IVF point and IVF topological spaces are specified. In third session of this object the Hausdorff axiom of Srivatsava, Lal and Srivatsava [10] is extended to IVF topological space and it is proved the aforementioned the concept is hereditary and constructive.

### Preliminary Definition

**Definition: 2.1 [14]** Let  $I = [0,1]$ . A **fuzzy set** in  $G$  (arbitrary non empty set) is a mapping from  $G$  into  $I$  that is a fuzzy set is an element of  $I^G$ .

### Definition: 2.2[13]

A **fuzzy point**  $g_u$  in a set  $G$ , with  $g$  in  $G$  and  $u$  in  $(0,1]$  is a fuzzy set in  $G$  defined by





**Bhavani Gokila and Vijayalakshmi**

$$g_u(\kappa) = u \text{ for } \kappa = g \text{ and}$$

$$g_u(\kappa) = 0 \text{ for } \kappa \neq g.$$

**Definition: 2.3[2]**

Let G be a nonempty set. A subset  $\tau \subseteq I^G$  is called a **fuzzy topology** on G iff  $\tau$  satisfies the following requirements

(i) 0 and 1 are constant fuzzy set belongs to  $\tau$ .

(ii)  $\beta_p \in \tau$  for each  $p \in P$  implies  $\bigvee_{p \in P} \beta_p \in \tau$ .

(iii)  $\beta, \gamma \in \tau$  implies  $\beta \wedge \gamma \in \tau$ .

The pair  $(G, \tau)$  is called a **fuzzy topological space**.

**Definition: 2.4[9]**

A fuzzy topological space  $(G, \tau)$  is said to be **fuzzy S-Hausdorff** if for any pair of distinct fuzzy points  $g_u, \kappa_v$  in G, there exists  $\beta, \gamma \in \tau$  such that  $g_u \in \beta, \kappa_v \in \gamma$  and  $\beta \wedge \gamma = 0$ .

**Definition: 2.5 [5],[6]**

“Let G be a non empty set. A function  $\widehat{\mu} : G \rightarrow [I]$  is called an **interval valued fuzzy set** (IVF set in short) in G, where [I] is the set of all closed subintervals of [0,1]. [I]<sup>G</sup> denotes the collection of all IVF sets in G.

For every  $\widehat{\mu} \in [I]^G$  and  $g \in G$ ,  $\widehat{\mu}(g) = [\mu^{lf}(g), \mu^{uf}(g)]$  is called the degree of membership of an element g to  $\widehat{\mu}$ , where  $\mu^{lf} : G \rightarrow I$  is called lower fuzzy set and  $\mu^{uf} : G \rightarrow I$  called upper fuzzy set in G respectively,  $\widehat{\mu}$  is denoted as  $\widehat{\mu} = [\mu^{lf}, \mu^{uf}]$ .

For any two IVF sets  $\widehat{\mu}, \widehat{\lambda}$  in  $[I]^G$

(i)  $\widehat{\mu} \subseteq \widehat{\lambda}$  iff  $\mu^{lf}(g) \leq \lambda^{lf}(g)$  and  $\mu^{uf}(g) \leq \lambda^{uf}(g)$  for every  $g \in G$

(ii)  $\widehat{\mu} = \widehat{\lambda}$  iff  $\widehat{\mu} \subseteq \widehat{\lambda}$  and  $\widehat{\lambda} \subseteq \widehat{\mu}$ .

(iii) The **union**  $\widehat{\mu} \cup \widehat{\lambda}$  and **intersection**  $\widehat{\mu} \cap \widehat{\lambda}$  are defined respectively as

$$\widehat{\mu} \cup \widehat{\lambda} = [\mu^{lf} \vee \lambda^{lf}, \mu^{uf} \vee \lambda^{uf}]$$

$$\widehat{\mu} \cap \widehat{\lambda} = [\mu^{lf} \wedge \lambda^{lf}, \mu^{uf} \wedge \lambda^{uf}]$$

(iv) The **complement** of  $\widehat{\mu}$ , denoted by  $\widehat{\mu}^c$  is defined as

$$\widehat{\mu}^c(g) = [1 - \mu^{uf}(g), 1 - \mu^{lf}(g)] \text{ for every } g \in G.$$

(v) For a family  $\{\widehat{\mu}_\eta / \eta \in \wp\}$  of IVF sets on a set G, the **union**  $\bigcup_{\eta \in \wp} \widehat{\mu}_\eta$  and the **intersection**  $\bigcap_{\eta \in \wp} \widehat{\mu}_\eta$  are defined, respectively, as

$$\bigcup_{\eta \in \wp} \widehat{\mu}_\eta = [ \bigvee_{\eta \in \wp} (\mu_\eta^{lf}), \bigvee_{\eta \in \wp} (\mu_\eta^{uf}), ]$$

$$\bigcap_{\eta \in \wp} \widehat{\mu}_\eta = [ \bigwedge_{\eta \in \wp} (\mu_\eta^{lf}), \bigwedge_{\eta \in \wp} (\mu_\eta^{uf}), ]$$

(vi) The **constant** IVF sets 0 and 1 are denoted as  $\widehat{0}$  and  $\widehat{1}$  which are defined, respectively, by

$$\widehat{0} = [0,0], \widehat{1} = [1,1]”$$

**Definition: 2.6 [6]**

For  $\phi \in G$  and for  $c = [c^{lf}, c^{uf}] \in [I]$  with  $c^{uf} > 0$ , the **IVF point** in G denoted as  $\widehat{c}_a = [c_a^{lf}, c_a^{uf}]$  is an IVF set in G which is defined as





**Bhavani Gokila and Vijayalakshmi**

$$c_a^{lf}(g) = c^{lf} \text{ for every } g = a \in G$$

$$c_a^{lf}(g) = 0 \text{ for every } g \neq a \in G \text{ and}$$

$$c_a^+(g) = c^{uf} \text{ for every } g = a \in G$$

$$c_a^+(g) = 0 \text{ for every } g \neq a \in G$$

**Definition: 2.7[10]**

Let G be a non empty set. A subset  $\widehat{\tau} \subset [I]^G$  is called an **IVF topology (Chang)** on G iff  $\widehat{\tau}$  satisfies the following axioms :

- (i)  $\widehat{0}, \widehat{1} \in \widehat{\tau}$
- (ii)  $\widehat{\mu}, \widehat{\lambda} \in \widehat{\tau}$  implies  $\widehat{\mu} \widehat{\cap} \widehat{\lambda} \in \widehat{\tau}$
- (iii)  $\widehat{\mu}_\eta \in \widehat{\tau}$  for each  $\eta \in \wp$  implies  $(\bigcup_{\eta \in \wp} \widehat{\mu}_\eta) \in \widehat{\tau}$ .

The pair (G,  $\widehat{\tau}$ ) is called an **IVF topological space**.

**Definition: 2.8[2]**

Let (G,  $\widehat{\tau}$ ) be an IVF topological space. Let  $K \subseteq G$ . Let  $\widehat{\mu} \in \widehat{\tau}$ . Define  $\widehat{\mu} / K = [\mu^{lf} / K, \mu^{uf} / K]$  as follows :

$$(\mu^{lf} / K)(z) = \mu^{lf}(z)$$

$$(\mu^{uf} / K)(z) = \mu^{uf}(z) \text{ if } z \in K.$$

Define  $(\widehat{\tau} / K) = \{(\widehat{\mu} / K) / \widehat{\mu} \in \widehat{\tau}\}$ , Then  $(\widehat{\tau} / K)$  is called the **IVF subspace topology** of K and  $(K, \widehat{\tau} / K)$  is called an **IVF subspace** of (G,  $\widehat{\tau}$ ).

**Definition: 2.9[2]**

Let  $\widehat{\mu} = [\mu^{lf}, \mu^{uf}]$  and  $\widehat{\lambda} = [\lambda^{lf}, \lambda^{uf}]$  be IVF sets on G and K respectively. The **Cartesian product** of  $\widehat{\mu}$  and  $\widehat{\lambda}$  is an IVF sets on  $G \times K$  denoted as  $\widehat{\mu} \widehat{*} \widehat{\lambda}$  and is defined as

$$(\widehat{\mu} \widehat{*} \widehat{\lambda}) = [(\mu^{lf} * \lambda^{lf}), (\mu^{uf} * \lambda^{uf})], \text{ where}$$

$$(\mu^{lf} * \lambda^{lf})(g, \kappa) = \min(\mu^{lf}(g), \lambda^{lf}(\kappa)) \text{ and}$$

$$(\mu^{uf} * \lambda^{uf})(g, \kappa) = \min(\mu^{uf}(g), \lambda^{uf}(\kappa)), \text{ for all } (g, \kappa) \in G \times K$$

**Definition: 2.10[2]**

“Let (G,  $\widehat{\tau}_1$ ) and (H,  $\widehat{\tau}_2$ ) be two IVF topological spaces. Then the **IVF product topology**  $\widehat{\tau}_1 \widehat{\times} \widehat{\tau}_2$  on  $G \times K$  is the IVF topology having the collection  $\{\widehat{\mu} \widehat{*} \widehat{\lambda} / \widehat{\mu} \in \widehat{\tau}_1, \widehat{\lambda} \in \widehat{\tau}_2\}$  as a basis.”

**Definition: 2.11[2]**

“Let  $\{(G_\eta, \widehat{\tau}_\eta) / \eta \in \wp\}$  be a family of IVF topological spaces and  $G = \prod_{\eta \in \wp} G_\eta$ . The IVF product topology on X is

the one with basic IVF open sets of the form

$$\prod_{\eta \in \wp} \widehat{\mu}_\eta = [\prod_{\eta \in \wp} \mu_\eta^{lf}, \prod_{\eta \in \wp} \mu_\eta^{uf}], \text{ where } \widehat{\mu}_\eta \in \widehat{\tau}_\eta \text{ and } \widehat{\mu}_\eta = \widehat{1} \text{ except for finitely many } \eta \text{'s.}$$

Here  $(\prod_{\eta \in \wp} \mu_\eta^{lf})(g_\eta)_{\eta \in \wp} = \bigwedge_{\eta \in \wp} \mu_\eta^{lf}(g_\eta)$ ,





**Bhavani Gokila and Vijayalakshmi**

$$\left(\prod_{\eta \in \wp} \mu_{\eta}^{uf}\right)(g_{\eta})_{\eta \in \wp} = \bigwedge_{\eta \in \wp} \mu_{\eta}^{uf}(g_{\eta}), \quad \text{for } (g_{\eta})_{\eta \in \wp} \in \prod_{\eta \in P} G_{\eta}."$$

**Interval valued fuzzy S - Hausdorff space**

**Definition: 3.1**

An IVF topological space  $(G, \hat{\tau})$  is said to be **IVF S-Hausdorff (or) IVF S-T<sub>2</sub>**, if for any pair of distinct IVF points  $\hat{c}_a = [c_a^{lf}, c_a^{uf}]$ ,  $\hat{d}_b = [d_b^{lf}, d_b^{uf}]$  in  $G$ , there exist two IVF open sets  $\hat{\mu} = [\mu^{lf}, \mu^{uf}]$ ,  $\hat{\lambda} = [\lambda^{lf}, \lambda^{uf}] \in \hat{\tau}$  such that  $c_a^{lf} \leq \mu^{lf}$ ,  $c_a^{uf} \leq \mu^{uf}$ ,  $d_b^{lf} \leq \lambda^{lf}$ ,  $d_b^{uf} \leq \lambda^{uf}$  that is  $\mu^{lf}(a) \geq c^{lf}$ ,  $\mu^{uf}(a) \geq c^{uf}$ ,  $\lambda^{lf}(b) \geq d^{lf}$ ,  $\lambda^{uf}(b) \geq d^{uf}$  and  $\hat{\mu} \hat{\cap} \hat{\lambda} = \hat{0}$ .

**Theorem : 3.2**

Subspace of an IVF S-Hausdorff space is IVF S-Hausdorff.

**Proof :**

Let  $(G, \hat{\tau})$  be an IVF S-Hausdorff space. Let  $K$  be a subspace of  $G$ .

To prove :

$(K, \hat{\tau} / K)$  is an IVF S-Hausdorff space.

Consider two IVF points  $\hat{c}_a = [c_a^{lf}, c_a^{uf}]$ ,  $\hat{d}_b = [d_b^{lf}, d_b^{uf}] \in K$  such that  $c_a^{lf} \neq d_b^{lf}$ ,  $c_a^{uf} \neq d_b^{uf}$ . Then  $\hat{c}_a, \hat{d}_b \in G$ .

"There exists two IVF open sets  $\hat{\mu} = [\mu^{lf}, \mu^{uf}]$  and  $\hat{\lambda} = [\lambda^{lf}, \lambda^{uf}] \in \hat{\tau}$  such that  $\mu^{lf}(a) \geq c^{lf}$ ,  $\mu^{uf}(a) \geq c^{uf}$ ,  $\lambda^{lf}(b) \geq d^{lf}$ ,  $\lambda^{uf}(b) \geq d^{uf}$  and  $\hat{\mu} \hat{\cap} \hat{\lambda} = \hat{0}$ .

Since  $K$  is a subspace of  $G$ .  $(\hat{\mu} / K), (\hat{\lambda} / K) \in (\hat{\tau} / K)$ , where  $(\hat{\mu} / K) = [\mu^{lf} / K, \mu^{uf} / K]$  and  $(\hat{\lambda} / K) = [\lambda^{lf} / K, \lambda^{uf} / K]$ .

Therefore

$$\begin{aligned} (\mu^{lf} / K) (a) &= \mu^{lf}(a) \geq c^{lf} \quad \text{if } a \in K \\ (\mu^{uf} / K) (a) &= \mu^{uf}(a) \geq c^{uf} \quad \text{if } a \in K \\ (\lambda^{lf} / K) (b) &= \lambda^{lf}(b) \geq d^{lf} \quad \text{if } b \in K \\ (\lambda^{uf} / K) (b) &= \lambda^{uf}(b) \geq d^{uf} \quad \text{if } b \in K \end{aligned}$$

Consider

$$(\hat{\mu} / K) \hat{\cap} (\hat{\lambda} / K) = [(\mu^{lf} / K) \wedge (\lambda^{lf} / K), (\mu^{uf} / K) \wedge (\lambda^{uf} / K)]$$

Consider for  $\kappa \in K \subseteq G$

$$\begin{aligned} ((\mu^{lf} / K) \wedge (\lambda^{lf} / K)) (\kappa) &= (\mu^{lf} / K) (\kappa) \wedge (\lambda^{lf} / K) (\kappa) \\ &= \mu^{lf}(\kappa) \wedge \lambda^{lf}(\kappa) \\ &= (\mu^{lf} \wedge \lambda^{lf}) (\kappa) \\ (\mu^{lf} / K) \wedge (\lambda^{lf} / K) &= \mu^{lf} \wedge \lambda^{lf} \\ ((\mu^{uf} / K) \wedge (\lambda^{uf} / K)) (\kappa) &= (\mu^{uf} / K) (\kappa) \wedge (\lambda^{uf} / K) (\kappa) \\ &= \mu^{uf}(\kappa) \wedge \lambda^{uf}(\kappa) \\ &= (\mu^{uf} \wedge \lambda^{uf}) (\kappa) \\ (\mu^{uf} / K) \wedge (\lambda^{uf} / K) &= \mu^{uf} \wedge \lambda^{uf} \\ \text{implies } (\hat{\mu} / K) \hat{\cap} (\hat{\lambda} / K) &= [\mu^{lf} \wedge \lambda^{lf}, \mu^{uf} \wedge \lambda^{uf}] \\ &= \hat{\mu} \hat{\cap} \hat{\lambda} \\ &= \hat{0} \end{aligned}$$

Therefore subspace of an IVF S-Hausdorff space is IVF S-Hausdorff.

**Theorem : 3.3**

Product of two IVF S-Hausdorff space is an IVF S-Hausdorff space.







**Bhavani Gokila and Vijayalakshmi**

**Proof :**

Let  $(G, \widehat{\tau}_1)$  and  $(K, \widehat{\tau}_2)$  be two IVF S-Hausdorff spaces.

To prove :

$(G \times K, \widehat{\tau}_1 \widehat{x} \widehat{\tau}_2)$  is an IVF S-Hausdorff space.

Consider two distinct IVF points  $\widehat{c}_{(a,e)}$ ,  $\widehat{d}_{(b,f)}$  over  $G \times K$ .

Either  $a \neq b$  or  $e \neq f$ . Assume  $a \neq b$ .

Then  $\widehat{c}_a = [c_a^{lf}, c_a^{uf}] \neq \widehat{d}_b = [d_b^{lf}, d_b^{uf}]$ . Therefore there exist two IVF open sets  $\widehat{\mu} = [\mu^{lf}, \mu^{uf}]$  and  $\widehat{\lambda} = [\lambda^{lf}, \lambda^{uf}] \in \widehat{\tau}$

such that  $\mu^{lf}(a) \geq c^{lf}$ ,  $\mu^{uf}(a) \geq c^{uf}$ ,  $\lambda^{lf}(b) \geq d^{lf}$ ,  $\lambda^{uf}(b) \geq d^{uf}$  and  $\widehat{\mu} \widehat{\cap} \widehat{\lambda} = \widehat{0}$ .

$\widehat{\mu}, \widehat{\lambda} \in \widehat{\tau}$  implies  $\widehat{\mu} * \widehat{1} \in \widehat{\tau}_1 \widehat{x} \widehat{\tau}_2$ ,  $\widehat{\lambda} * \widehat{1} \in \widehat{\tau}_1 \widehat{x} \widehat{\tau}_2$

where

$$\widehat{\mu} * \widehat{1} = [\mu^{lf} * 1^{lf}, \mu^{uf} * 1^{uf}] \text{ and}$$

$$\widehat{\lambda} * \widehat{1} = [\lambda^{lf} * 1^{lf}, \lambda^{uf} * 1^{uf}]$$

Consider

$$\begin{aligned} (\mu^{lf} * 1^{lf})(a,e) &= \min(\mu^{lf}(a), 1^{lf}(e)), \text{ for } (a, e) \in G \times K \\ &= \mu^{lf}(a) \\ &\geq c^{lf} \end{aligned}$$

$$\begin{aligned} (\mu^{uf} * 1^{uf})(a,e) &= \min(\mu^{uf}(a), 1^{uf}(e)), \text{ for } (a, e) \in G \times K \\ &= \mu^{uf}(a) \\ &\geq c^{uf} \end{aligned}$$

$$\begin{aligned} (\lambda^{lf} * 1^{lf})(b,f) &= \min(\lambda^{lf}(b), 1^{lf}(f)), \text{ for } (b, f) \in G \times K \\ &= \lambda^{lf}(b) \\ &\geq d^{lf} \end{aligned}$$

$$\begin{aligned} (\lambda^{uf} * 1^{uf})(b,f) &= \min(\lambda^{uf}(b), 1^{uf}(f)), \text{ for } (b, f) \in G \times K \\ &= \lambda^{uf}(b) \\ &\geq d^{uf} \end{aligned}$$

Therefore  $\widehat{c}_{(a,e)} \in \widehat{\mu} * \widehat{1}$  and

$$\widehat{d}_{(b,f)} \in \widehat{\lambda} * \widehat{1}$$

Also

$$\widehat{\mu} \widehat{\cap} \widehat{\lambda} = \widehat{0}$$

Implies  $[\mu^{lf} \wedge \lambda^{lf}, \mu^{uf} \wedge \lambda^{uf}] = [0, 0]$

Implies  $(\mu^{lf} \wedge \lambda^{lf})(g) = 0, (\mu^{uf} \wedge \lambda^{uf})(g) = 0$ , for all  $g \in G$

Implies  $\mu^{lf}(g) \wedge \lambda^{lf}(g) = 0, \mu^{uf}(g) \wedge \lambda^{uf}(g) = 0$ , for all  $g \in G$

Implies  $\mu^{lf}(g) = 0$  and  $\lambda^{lf}(g) = 0, \mu^{uf}(g) = 0$  and  $\lambda^{uf}(g) = 0$ , for all  $g \in G$

Implies  $\mu^{lf}(g) \wedge 1^{lf}(\kappa) = 0$  and  $\lambda^{lf}(g) \wedge 1^{lf}(\kappa) = 0$ ,  
 $\mu^{uf}(g) \wedge 1^{uf}(\kappa) = 0$  and  $\lambda^{uf}(g) \wedge 1^{uf}(\kappa) = 0$ , for all  $g \in G$  and  $\kappa \in K$ .

Implies  $(\mu^{lf} * 1^{lf})(g, \kappa) = 0$  and  $(\lambda^{lf} * 1^{lf})(g, \kappa) = 0$ ,  
 $(\mu^{uf} * 1^{uf})(g, \kappa) = 0$  and  $(\lambda^{uf} * 1^{uf})(g, \kappa) = 0$ , for all  $(g, \kappa) \in G \times K$ .

$$\Rightarrow ((\mu^{lf} * 1^{lf}) \wedge (\lambda^{lf} * 1^{lf}))(g, \kappa) = 0,$$

$$((\mu^{uf} * 1^{uf}) \wedge (\lambda^{uf} * 1^{uf}))(g, \kappa) = 0, \text{ for all } (g, \kappa) \in G \times K.$$

$$\Rightarrow [(\mu^{lf} * 1^{lf}) \wedge (\lambda^{lf} * 1^{lf}), (\mu^{uf} * 1^{uf}) \wedge (\lambda^{uf} * 1^{uf})] = [0, 0]$$

$$\Rightarrow (\widehat{\mu} * \widehat{1}) \widehat{\cap} (\widehat{\lambda} * \widehat{1}) = \widehat{0}$$





**Bhavani Gokila and Vijayalakshmi**

Hence  $(G \times K, \widehat{\tau}_1 \widehat{x} \widehat{\tau}_2)$  is an IVF S-Hausdorff space.

**Theorem : 3.4**

Arbitrary product of IVF S- Hausdorff spaces is an IVF S-Hausdorff.

**Proof :**

Let  $\{(G_\eta, \widehat{\tau}_\eta) / \eta \in \wp\}$  be a collection of IVF S-Hausdorff space.

$$\text{Let } G = \prod_{\eta \in \wp} G_\eta \text{ and } \widehat{\tau} = \prod_{\eta \in \wp} \widehat{\tau}_\eta .$$

Consider two distinct IVF points  $\widehat{c}_{(a_\eta)_{\eta \in \wp}}, \widehat{d}_{(b_\eta)_{\eta \in \wp}} \in \prod_{\eta \in \wp} G_\eta$ , for all  $\eta \in \wp$ .

Then  $(a_\eta)_{\eta \in \wp} \neq (b_\eta)_{\eta \in \wp}$

Assume  $a_\sigma \neq b_\sigma$  for some  $\sigma \in \wp$ .

Therefore there exists two IVF open sets  $\widehat{\mu}_\sigma = [\mu_\sigma^{lf}, \mu_\sigma^{uf}]$  and  $\widehat{\lambda}_\sigma = [\lambda_\sigma^{lf}, \lambda_\sigma^{uf}] \in \widehat{\tau}_\sigma$  such that  $(\mu_\sigma^{lf})(a_\sigma) \geq c^{lf}$ ,  $(\mu_\sigma^{uf})(a_\sigma) \geq c^{uf}$ ,  $(\lambda_\sigma^{lf})(b_\sigma) \geq d^{lf}$ ,  $(\lambda_\sigma^{uf})(b_\sigma) \geq d^{uf}$  and  $\widehat{\mu}_\sigma \widehat{\cap} \widehat{\lambda}_\sigma = \widehat{0}$ .

$$\text{Let } \widehat{\mu} = \prod_{\eta \in \wp} \widehat{\mu}_\eta, \text{ where } \widehat{\mu}_\eta = \widehat{1}_\eta \text{ for } \eta \neq \sigma \text{ and}$$

$$\widehat{\lambda} = \prod_{\eta \in \wp} \widehat{\lambda}_\eta, \text{ where } \widehat{\lambda}_\eta = \widehat{1}_\eta \text{ for } \eta \neq \sigma$$

$$\text{Then } \widehat{\mu}, \widehat{\lambda} \in \prod_{\eta \in \wp} \widehat{\tau}_\eta$$

$$\widehat{\mu} = \prod_{\eta \in \wp} \widehat{\mu}_\eta = [\prod_{\eta \in \wp} \mu_\eta^{lf}, \prod_{\eta \in \wp} \mu_\eta^{uf}] ,$$

$$\widehat{\lambda} = \prod_{\eta \in \wp} \widehat{\lambda}_\eta = [\prod_{\eta \in \wp} \lambda_\eta^{lf}, \prod_{\eta \in \wp} \lambda_\eta^{uf}]$$

$$\begin{aligned} (\prod_{\eta \in \wp} \mu_\eta^{lf})(a_\eta)_{\eta \in \wp} &= \min \mu_\eta^{lf}(a_\eta)_{\eta \in \wp} \\ &= \mu_\sigma^{lf}(a_\sigma), \text{ for some } \sigma \in \wp \\ &\geq c^{lf} \end{aligned}$$

$$\begin{aligned} (\prod_{\eta \in \wp} \mu_\eta^{uf})(a_\eta)_{\eta \in \wp} &= \min \mu_\eta^{uf}(a_\eta)_{\eta \in \wp} \\ &= \mu_\sigma^{uf}(a_\sigma) \text{ for some } \sigma \in \wp \\ &\geq c^{uf} \end{aligned}$$

$$\begin{aligned} (\prod_{\eta \in \wp} \lambda_\eta^{lf})(b_\eta)_{\eta \in \wp} &= \min \lambda_\eta^{lf}(b_\eta)_{\eta \in \wp} \\ &= \lambda_\sigma^{lf}(b_\sigma), \text{ for some } \sigma \in \wp \\ &\geq d^{lf} \end{aligned}$$

$$\begin{aligned} (\prod_{\eta \in \wp} \lambda_\eta^{uf})(b_\eta)_{\eta \in \wp} &= \min \lambda_\eta^{uf}(b_\eta)_{\eta \in \wp} \\ &= \lambda_\sigma^{uf}(b_\sigma), \text{ for some } \sigma \in \wp \\ &\geq d^{uf} \end{aligned}$$

Consider,





**Bhavani Gokila and Vijayalakshmi**

$$\bar{\mu} \hat{\cap} \hat{\lambda} = \prod_{\eta \in \wp} \hat{\mu}_\eta \hat{\cap} \prod_{\eta \in \wp} \hat{\lambda}_\eta$$

$$\prod_{\eta \in \wp} \hat{\mu}_\eta \hat{\cap} \prod_{\eta \in \wp} \hat{\lambda}_\eta = [(\prod_{\eta \in \wp} \mu_\eta^{lf} \wedge \prod_{\eta \in \wp} \lambda_\eta^{lf}), (\prod_{\eta \in \wp} \mu_\eta^{uf} \wedge \prod_{\eta \in \wp} \lambda_\eta^{uf})]$$

Then,

$$\begin{aligned} (\prod_{\eta \in \wp} \mu_\eta^{lf} \wedge \prod_{\eta \in \wp} \lambda_\eta^{lf}) (g_\eta)_{\eta \in \wp} &= (\prod_{\eta \in \wp} \mu_\eta^{lf}) (g_\eta)_{\eta \in \wp} \wedge (\prod_{\eta \in \wp} \lambda_\eta^{lf}) (g_\eta)_{\eta \in \wp} \\ &= \min (\mu_\eta^{lf}) (g_\eta)_{\eta \in \wp} \wedge \min (\lambda_\eta^{lf}) (g_\eta)_{\eta \in \wp} \\ &= \mu_\sigma^{lf} (g_\sigma) \wedge \lambda_\sigma^{lf} (g_\sigma) \text{ for some } \sigma \in \wp \\ &= (\mu_\sigma^{lf} \wedge \lambda_\sigma^{lf}) (g_\sigma) , \text{ for some } \sigma \in \wp \\ &= 0 \end{aligned}$$

$$\begin{aligned} (\prod_{\eta \in \wp} \mu_\eta^{uf} \wedge \prod_{\eta \in \wp} \lambda_\eta^{uf}) (g_\eta)_{\eta \in \wp} &= (\prod_{\eta \in \wp} \mu_\eta^{uf}) (g_\eta)_{\eta \in \wp} \wedge (\prod_{\eta \in \wp} \lambda_\eta^{uf}) (g_\eta)_{\eta \in \wp} \\ &= \min (\mu_\eta^{uf}) (g_\eta)_{\eta \in \wp} \wedge \min (\lambda_\eta^{uf}) (g_\eta)_{\eta \in \wp} \\ &= \mu_\sigma^{uf} (g_\sigma) \wedge \lambda_\sigma^{uf} (g_\sigma) , \text{ for some } \sigma \in \wp \\ &= (\mu_\sigma^{uf} \wedge \lambda_\sigma^{uf}) (g_\sigma) , \text{ for some } \sigma \in \wp \\ &= 0 \end{aligned}$$

Therefore  $\bar{\mu} \hat{\cap} \hat{\lambda} = \prod_{\eta \in \wp} \hat{\mu}_\eta \hat{\cap} \prod_{\eta \in \wp} \hat{\lambda}_\eta = \hat{0}$ .

Hence arbitrary product of IVF S-Hausdorff spaces is an IVF S-Hausdorff space.

**CONCLUSION**

In this work , the idea of IVF S - Hausdorff space is studied and proved its related properties .

**REFERENCES**

1. "Akhtar zeb,Saleem Abpullah,Majip khan and AbdulMajid.,"CUBIC TOPOLOGY",International Journal of computer science and Information Security(UCSIS).V01 14,N0.8,August 2016.
2. Bhavani Gokila .D.,and Vijayalakshmi .V.M, "Interval Valued Fuzzy W-Hausdorff spaces" ,(submitted)
3. C.L.Chang , " Fuzzy Topological Spaces" ,Journal of Mathematical Analysis and Application ,Vol.24, no.1,pp.182-190 ,1968.
4. Chattopadhyay,K.C. and Samantha, S.K., "Fuzzy Topology Fuzzy Closure Opertator, Fuzzy Compactness and Fuzzy Connectedness ,Fuzzy sets and Systems", 54 (1993),207-212.
5. Gantner,T.E., Steinlage , R.C , and Warren,R.H., "Compactness in fuzzy topological spaces, J.Math.Appl.,62(1978),547-562.
6. JU Hongmei,Yuan Xuehai,"Fuzzy connectedness in interval-valued fuzzy Topological spaces", second International symposium on Intelligent Information Technology and security informatics.
7. Y.B.Jun,C.S.Kun,K.U.Yang,,"cubic sets and operations on cubic sets", volume 4,No.1.(JULY2012)PP 83-98 . .
8. Katsaras,A.K.(1981) ,"Ordered fuzzy topological spaces",Journal of mathematical Analysis and Applications ,84,44-58.
9. Srivastava.R., "On Separation Axioms in a Newly Defined Fuzzy Topology ,Fuzzy sets and Systems" ,62(1994) ,341-346.





**Bhavani Gokila and Vijayalakshmi**

10. Srivastava.R.,LaI,S.N and Srivastava A.K., "Fuzzy Hausdorff Topological Spaces", J.Math. Anal. Appl., 81 (1981), 363-367.
11. Tapas kumar ,Mondal and S.K Samanta,"Topology of interval valued fuzzy sets",Indian J.pure appl.Math.30(1):23-38.
12. I.B Turksen., " Interval-valued fuzzy sets based on normal forms" ,fuzzy sets and system 20(1986)191-210.
13. I.B.Turksen., " Interval valued fuzzy sets and compensatory and fuzzy sets and system" 51(1992)295-307.
14. C.K. Wong , " Fuzzy Topology: Product and Quotient Theorems", Journal of Mathematical Analysis and Applications,Vol.45,no.2,pp.512-521,1974.
15. L.A.Zaheh., "Fuzzy sets", Inform.control8(1965)338-353.
16. L.A.Zadeh, " The concept of a linguistic variable and its application to approximate Reasoning-I. Inform.sci.8 (1975),199-249."





## Numerical Method for Solving Differential Equations using Haar and Daubechies Wavelet Transform

Ravikumar.K<sup>1</sup> and Ithaya Priya.B<sup>2</sup>

<sup>1</sup>Assistant Professor, Engineering Mathematics, Faculty of Engineering and Technology, Annamalai University, Annamalai Nagar, Tamil Nadu, India, 608002

<sup>2</sup>Research Scholar, Department of Mathematics, Annamalai University, Annamalai Nagar, Tamil Nadu, India, 608002

Received: 23 Dec 2021

Revised: 04 Jan 2022

Accepted: 18 Jan 2022

### \*Address for Correspondence

**Ravikumar.K**

Assistant Professor,  
Engineering Mathematics,  
Faculty of Engineering and Technology,  
Annamalai University, Annamalai Nagar,  
Tamil Nadu, India, 608002



This is an Open Access Journal / article distributed under the terms of the **Creative Commons Attribution License** (CC BY-NC-ND 3.0) which permits unrestricted use, distribution, and reproduction in any medium, provided the original work is properly cited. All rights reserved.

### ABSTRACT

Wavelet transform is an emerging proficient technique in the area of applied mathematics. Wavelets are found to be an important mathematical tool for analyzing problems and equation in harmonic analysis. This method replaces the conventional numerical methods due to its distinguished characteristics. Here we had analyzed ordinary differential equations, partial differential equations using Haar and Daubechies wavelets and compared the solution with exact solution.

**Keywords:** Wavelet Transform, Daubechies Wavelet, Haar Wavelet, Partial differential equation, Numerical analysis.

### INTRODUCTION

There was a huge demand for a perfect mathematical tool to analyze the signals for multidisciplinary application, while Fourier transform was somewhat managed to satisfy the requirement. Fourier transform is ideal only for the stationary data's where it cannot predict data with transient events. Wavelet transform which was introduced in early 80's where reported to be successful in analyzing non stationary data's [1]. The wavelets are unique functions with important properties in harmonic and functional analysis. Using wavelet function we can achieve a perfect time resolution for high frequency transients and frequency resolution for low frequency components. Due to this strong features and capability, the wavelets attracted the scientists and academicians to implement this as an efficient mathematical tool for various signal and image processing applications and not limited to quantum mechanics, computer science, mathematics, communication systems, biomedical systems, geographical and satellite sensing[2]. When considering engineering applications, solving differential equations by wavelet functions are unavoidable for





**Ravikumar and Ithaya Priya**

obtaining required efficient solutions. Wavelet methods provide suitable and efficient algorithms to solve partial differential equations [3]. The wavelet algorithms will be fast and produce results with minimum computational time. It will produce solution very similar to the exact solution. The percentage of errors will be very minimum when compared to various methods. Wavelet based computation will be only on appropriate quantity which consumes less computational time in analyzing unnecessary quantities. These properties of wavelets made it very optimistic in numerical methods of solving differential equations [4]. The wavelet transform has overcome the commonly used numerical methods like Finite Difference Method (FDM), Finite Volume Methods (FVM) and Finite Elements Method (FEM). The advantages in all other methods are found together in wavelet transform. In this paper, we used wavelet functions like Haar and Daubechies to solve the differential equations [5,6]. Initially we solved the ordinary differential equation for exponential growth and exponential decay. Then we applied Haar wavelet to solve Van Der Pol equation. Finally the Burgers differential equations were solved using Daubechies wavelet functions for specified boundary condition [7].

**Preliminaries**

The term wavelet came into the scenario of mathematics as the successor of the Fourier transform. Wavelets are used to represent the different functions for the specific class of function  $f$  as mentioned in equation 1.

$$f(x) = \sum_{n=0}^{\infty} a_n f_x(x) \quad \text{-----1}$$

The wavelet is a wave like oscillation, whose amplitude begins with zero then increases to maximum then decreases to minimum then return back to zero. Equivalent mathematical conditions for wavelets are:

$$\int_{-\infty}^{\infty} |\Psi(t)|^2 dt < \infty; \quad \text{-----2}$$

$$\int_{-\infty}^{\infty} |\Psi(t)| dt = 0; \quad \text{-----3}$$

$$\int_{-\infty}^{\infty} \frac{|\Psi(\omega)|^2}{|\omega|} d\omega < \infty; \quad \text{-----4}$$

Where  $\bar{\Psi}(\omega)$  is the fourier transform of  $\Psi(\omega)$ . Wavelet transform is used to analyze and represent functions having discontinuities and sharp peaks. Wavelet can be denoted by the equation 5,

$$\Psi_{a,b}(t) = \frac{1}{\sqrt{|a|}} \Psi\left(\frac{t-b}{a}\right), \quad a, b \in R, a \neq 0 \quad \text{-----5}$$

Where  $a, b$  are the scaling parameter and translation parameter respectively, when  $|a| < 1$ , then the wavelet is the compressed version of the mother wavelet since the translation parameter determines the time location of the wavelet. However when  $|a| > 1$ , then  $\Psi_{a,b}(t)$  has larger time-width than  $\Psi(t)$ . Wavelet transform of the above mentioned parameters can be defined as shown in equation 6,

$$W_{a,b}(t) = \int_t f(t) \frac{1}{\sqrt{|a|}} \Psi\left(\frac{t-b}{a}\right) dt \quad \text{-----6}$$

Wavelet transform can be classified basically as continuous wavelet transform and discrete wavelet transform. The continuous wavelet transform  $W_{\Psi}(f)$  of  $f \in L_2(R)$  with respect to  $\Psi$  is defined as equation 7,

$$W_{\Psi}(b, a) = |a|^{-\frac{1}{2}} \int_{-\infty}^{\infty} f(x) \Psi\left(\frac{x-b}{a}\right) \quad \text{-----7}$$

The discrete wavelet transform of function  $f$  for  $f \in L^2$  is shown in equation 8,

$$C_f(j, k) = \int_R f(x) \overline{\Psi_{j,k}(x)} dx \quad \text{-----8}$$

$$= \langle f, \Psi_{j,k} \rangle_{L^2}$$

**Haar Wavelet for Scaling Partial Differential Equation (PDE)**

The Haar wavelet is the famous among wavelets family due to its simplicity and for its wide application range such as image coding, edge extraction and binary logic design[8]. Haar wavelet family for scaling functions  $0 \leq x \leq 1$  is defined as equation 9,

$$f_i(x) = \begin{cases} 1 & \text{for } x \in (a, b), \\ -1 & \text{for } x \in (b, c), \\ 0 & \text{elsewhere} \end{cases} \quad \text{-----9}$$





**Ravikumar and Ithaya Priya**

Where,  $a = \frac{k}{m}$ ,  $b = \frac{k+0.5}{m}$ ,  $c = \frac{k+1}{m}$  and  $m = 2^j, j = 0,1,2,\dots,j, k = 0,1,2,\dots,m - 1$ . Here  $j$  is the level of wavelets,  $k$  denotes translation parameters and  $j$  denotes the maximum level of resolution. The index  $i$  in  $f_i(x)$  is determined by  $i = m + k + 1$ . Where the values of  $k$  and  $m$  are 0 and 1 respectively. The maximum value of  $i = 2^{j+1} = 2m[9,10]$ .

$$p_i(x) = \int_0^x f_i(x)dx \quad \text{-----10}$$

$$q_i(x) = \int_0^x p_i(x)dx \quad \text{-----11}$$

When  $i=1$ , then

$$f_1(x) = \begin{cases} 1 & \text{for } x \in (0,1), \\ 0 & \text{elsewhere} \end{cases} \quad \text{-----12}$$

$$p_1(x) = \begin{cases} x & \text{for } x \in (0,1), \\ 0 & \text{elsewhere} \end{cases} \quad \text{-----13}$$

$$q_1(x) = \begin{cases} \frac{x^2}{2} & \text{for } x \in (0,1), \\ 0 & \text{elsewhere} \end{cases} \quad \text{-----14}$$

Or else

$$f_i(x) = \begin{cases} 1 & \text{for } x \in (a,b), \\ -1 & \text{for } x \in (b,c), \\ 0 & \text{elsewhere} \end{cases} \quad \text{-----15}$$

$$p_i(x) = \begin{cases} x-a & \text{for } x \in (a,b), \\ c-x & \text{for } x \in (b,c), \\ 0 & \text{elsewhere} \end{cases} \quad \text{-----16}$$

$$q_i(x) = \begin{cases} \frac{(x-a)^2}{2} & \text{for } x \in (a,b), \\ \frac{(\alpha-\beta)^2+(\beta-\gamma)^2-(\gamma-x)^2}{2} & \text{for } x \in (b,c), \\ \frac{(\alpha-\beta)^2+(\beta-\gamma)^2-(\gamma-x)^2}{2} & \text{for } x \in (c,1) \\ 0 & \text{elsewhere} \end{cases} \quad \text{-----17}$$

**Characteristics of Haar Wavelet**

1. Haar wavelet is very well localized in the time domain, but not continuous.
2. Any continuous real function can be approximated by linear combination of  $\Phi(t), \Phi(2t), \Phi(4t), \dots, \Phi(2^k t), \dots$  and their shifted functions. This extends the function space where any function can be approximated by continuous functions.
3. Any continuous real function can be approximated by linear combination of the constant functions and their shifted functions.
4. Each two Haar function is orthogonal to each other i.e.
5. Wavelet function or scaling function with different scale  $m$  have a functional relationship  $\Phi(t) = \Phi(2t) + \Phi(2t-1)$  and  $= \Phi(2t) - \Phi(2t-1)$ .

**Solving Ordinary Differential Equation using Haar Wavelet**

**Case1:** Here we considered simple and frequently used ODE's for exponential growth as in equation 18,

$$\frac{dy}{dt} = \lambda y \quad \text{-----18}$$

Its exact solution is  $y(t) = y_0 e^{\lambda t}$ . The above mentioned equation is used to represent growth in biological systems, positive feedback in electrical systems and in chemical reactions which produce its own catalyst. The comparison of approximate Haar solution and exact solution is cited in the tables below.

$$y(0) = 1.00 \text{ and } y(1) = 16$$

The values obtained were tabulated to calculate the error component when the ODE is been solved by Haar wavelet. For better understanding the values are represented in graphical form as shown in the Figure.1





### Ravikumar and Ithaya Priya

**Case 2:** Here we consider the ODE for exponential decay in equation 19, used for capacitor discharge, radioactive decay or decomposition of material from a system.

$$\frac{dy}{dt} = -\lambda y \quad \text{-----19}$$

Its exact solution is  $y(t) = y_0 e^{-\lambda t}$ .  $y(0) = 1.00$  and  $y(1) = 16$

**Case 3:** Van Der Pol Equation is given in equation 20,

$$y'' + y' + y + y^2 y' = -\sin t - \sin t \cos^2 t \quad \text{-----20}$$

With initial condition  $y(0)=1, y'(0) = 0$ .

The exact solution is  $u = \cos t$

### Solving differential equation using daubacheuis wavelet.

**Case 4:** Consider Burgers equation with initial and boundary conditions as shown in equation 21,

$$u(x, 0) = \frac{2\gamma\pi\sin(\pi x)}{\sigma + \cos(\pi x)}, 0 \leq x \leq 1 \quad \text{-----21}$$

Boundary conditions are  $u(0,t)=0=u(1,t)$ ,  $0 \leq t \leq 1$ . The exact solution is given as,

$$u(x, t) = \frac{2\gamma\pi e^{-\pi^2\gamma t} \sin(\pi x)}{\sigma + e^{-\pi^2\gamma t} \cos(\pi x)}, 0 \leq x, t \leq 1 \quad \text{-----22}$$

## CONCLUSION

In his paper, we had implemented wavelet transform in solving different ODE and PDE using Haar and Daubechies mother wavelets. This proposed wavelet based numerical method for solving differential equation dominates the conventional methods in many factors. Here the solution achieved using wavelet transform were compared with the error between them was found to be very minimum, which is negligible. Hence it can be concluded that wavelet based numerical analysis is quite suitable, accurate, and efficient for solving differential equations in comparison to other classical methods.

## REFERENCES

1. S. Gopalkrishnan, Mira Mitra, "Wavelet Methods for Dynamical Problems," CRC Press,2010.
2. L. Debnath, "Wavelet Transform and their Applications," Birkhauser Boston,2002.
3. S. Saha Ray, "On Haar wavelet operational matrix of general order and its application for the numerical solution of fractional Bagley Torvik equation," Applied Mathematics and Computation (Elsevier), **218**, 9, pp. 5239-5248,2011.
4. S. Islam, I. Aziz, B. Sarler, "Numerical Solution of second order boundary value problems by collocation method with Haar Wavelets," Mathematical and Computer Modeling (Elsevier), **52**, pp. 1577-1590,2010.
5. U. Lepik, "Numerical Solution of evolution equations by the Haar wavelet method", Applied Mathematics and Computation (Elsevier), **185**, pp. 695-704,2006.
6. U. Lepik, "Application of Haar wavelet transform to solving integral and differential equations," Applied Mathematics and Computation (Elsevier), **57**, 1, pp. 28-46,2007.
7. U. Lepik, "Numerical solution of differential equations using Haar wavelets," Mathematics and Computers in Simulation(Elsevier), **68**, pp. 127-143,2005
8. U. Lepik, "Haar wavelet method for solving stiff differential equations," Mathematical modeling and analysis (Taylor and Francis), **14**, 4, pp. 467-481, 2009.
9. U. Lepik, "Haar Wavelet method for solving higher order differential equations," International Journal of Mathematics and Computation (CESER Publications), **1**, N08, pp. 84-94,2008.
10. C. F. Chen, C. H. Hsiao, "Haar Wavelet Method for solving Lumped and distributed parameter systems," IEEE Proceeding Control Theory Appl., **144**, 1, pp. 87-94,1997.







**Ravikumar and Ithaya Priya**

**Table.1 Comparison of Exact Solution with Haar Solution with Error Component**

X	Exact Solution	Haar Solution	Error
0	1	1	0
0.125	1.414	1.3	0.114
0.250	2	1.8	0.200
0.375	2.828	2.4	0.428
0.400	3.012	2.9	0.112
0.500	4	3.12	0.880
0.625	5.65	5.02	0.630
0.750	8	7.24	0.760
0.800	11.31	10	1.310
1	16	15.56	0.440

**Table.2 Comparison of Exact Solution with Haar Solution for  $\frac{dy}{dt} = -\lambda y$**

X	Exact Solution	Haar Solution	Error
0	1	1	0
0.1	1.414	1.31	0.104
0.2	2	1.927	0.073
0.3	2.82	2.79	0.03
0.4	3.36	3.12	0.24
0.5	4.75	4.6	0.15
0.6	6.72	6.5	0.22
0.7	8	7.98	0.02
0.8	11.3	10.98	0.32
0.9	13.45	13.12	0.33
1	16	15.952	0.048

**Table.3 Comparison of Exact Solution with Haar Solution for Van Der Pol Equation**

X	Exact Solution	Haar Solution	Error
0	1	1	0
0.125	0.998	0.989	0.009
0.250	0.959	0.947	0.012
0.370	0.937	0.926	0.011
0.560	0.965	0.893	0.072
0.620	0.81	0.802	0.008
0.875	0.64	0.632	0.008

**Table.4 Comparison of Exact Solution with Daubechies Solution For Burgers Equation**

X	Exact Solution	Daubacheuis Solution	Error
0.1	0.1	0.03	0.07
0.2	0.12	0.114	0.006
0.3	0.19	0.173	0.017
0.4	0.26	0.252	0.008
0.5	0.31	0.303	0.007
0.6	0.35	0.342	0.008
0.7	0.33	0.321	0.009
0.8	0.29	0.282	0.008
0.9	0.22	0.212	0.008





**Ravikumar and Ithaya Priya**

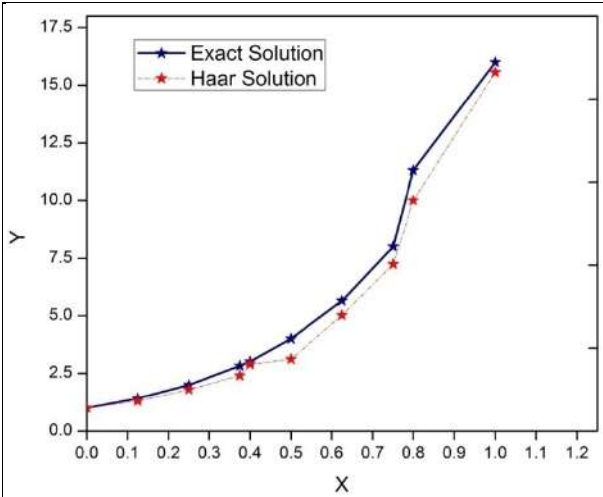


Figure.1 Graphical representation of Haar solution with exact solution for  $\frac{dy}{dt} = \lambda y$

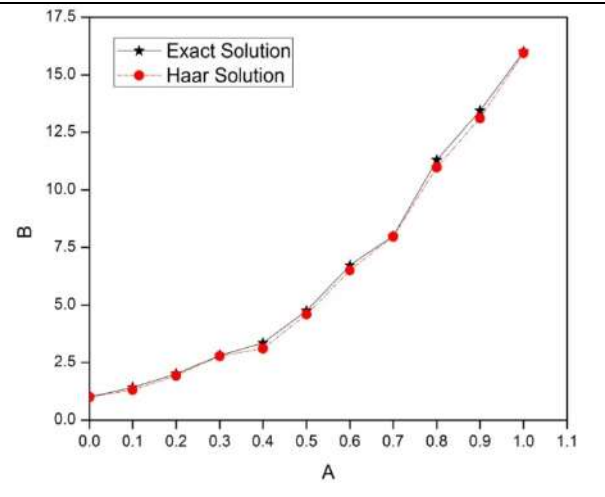


Figure.2 Graphical representation of Haar solution with exact solution for  $\frac{dy}{dt} = -\lambda y$

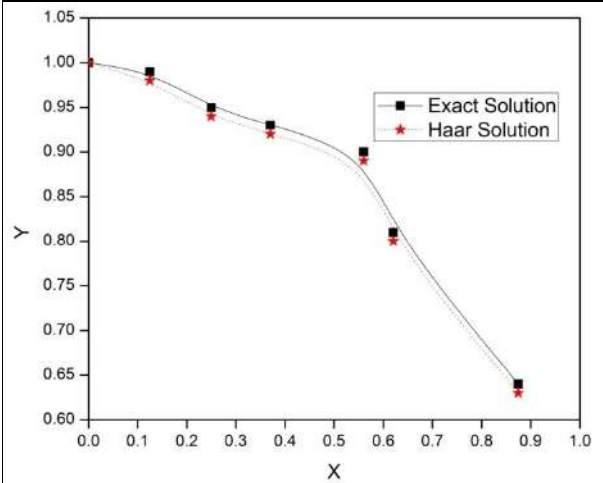


Figure.3 Graphical representation of Haar solution with exact solution for Van Der Pol Equation

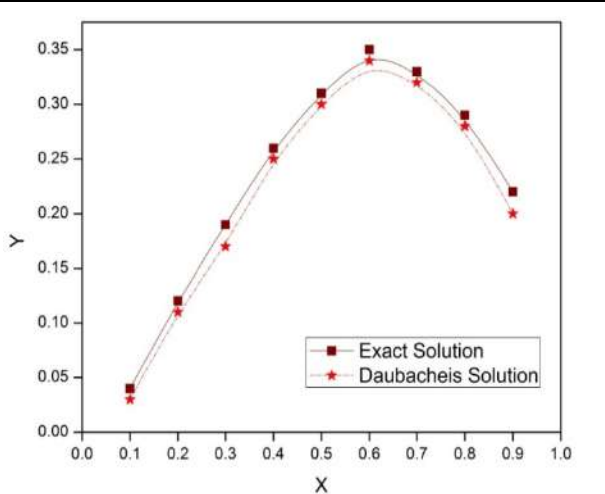


Figure.4 Graphical representation of Haar solution with exact solution for Burgers equation





## Antimicrobial Effect of Some Mineral Clays *In vitro*

Priya V<sup>1\*</sup> and Sangeetha N J<sup>2</sup>

<sup>1</sup>Research Scholar, Women's Christian College, Nagercoil, Affiliated by M.S. University, Tirunelveli, Tamil Nadu, India.

<sup>2</sup>Assistant Professor in Chemistry, Women's Christian College, Nagercoil, Tamil Nadu, India.

Received: 03 Nov 2021

Revised: 18 Dec 2021

Accepted: 17 Jan 2022

### \*Address for Correspondence

#### Priya V

Research Scholar,  
Women's Christian College,  
Nagercoil, Affiliated by M.S. University  
Tirunelveli, Tamil Nadu, India.  
Email: priyapreetisha2016@gmail.com



This is an Open Access Journal / article distributed under the terms of the **Creative Commons Attribution License** (CC BY-NC-ND 3.0) which permits unrestricted use, distribution, and reproduction in any medium, provided the original work is properly cited. All rights reserved.

### ABSTRACT

The use of environmental mineral clay to cure microbial infections has been evident, since the earliest recorded history, and exact clay minerals may show appreciate in the treatment of bacterial diseases, with infections for which there are no active antibiotics, such as multi-drug resistant infections. The aim of this study is to identify new inhibitory agents in an era when bacterial antibiotic resistance continues to challenge human health and the availability of new antimicrobial compounds is limited. Our results indicated that mineral clay could provide an alternative treatment against numerous human bacterial infections. Accepting the antimicrobial mechanism of organic clays can lead to their safe use or design of new antimicrobial products.

**Keywords:** antimicrobial, diseases, heal, mineral clay and understanding.

### INTRODUCTION

Clays are fine grained, earthy materials chemically formed from hydrated aluminium, iron, and magnesium silicates. They consist of extremely small crystalline particles of a restricted number of minerals known as clay minerals, and may also contain organic matter, soluble salts, quartz particles, pyrite, calcite, and other residual and amorphous minerals (Bonotto, 2006; Santos *et al.*, 1989; Vieira and Monteiro, 2003). They are found in nature in a variety of types and colours and have many useful applications. Clays are some of the oldest materials used for healing purposes in traditional medicine (Abrahams, 2002; Moraes *et al.*, 2017; Gomes and Silva, 2007; Veniale, 1997; Carretero *et al.*, 2013). Clay minerals have been used throughout the world for curative and preventive purposes (Carretero *et al.*, 2013). Clay minerals are pervasive in natural soils. They have a small particle size of less than 2.0 μm in diameter and bulk density of 265g/cm<sup>3</sup> as defined by Stock's law (Moore *et al.*, 1997). This provides a high specific surface area for a cation exchange capacity, and high absorptive and adsorptive capabilities, for that, they have been used in a variety of cosmetics and pharmaceutical formulations. For example, the extremely fine particles of steatite (expandable clay



**Priya and Sangeetha**

minerals) and kaolin group minerals are used to remove oils, secretions, toxins and contaminants from skin by absorbing and absorbing moisture and impurities from the skin. Clay also serves to cleans and refresh the skin surface, and aids in the healing of topical blemishes in many cosmetics (Williams and Haydel, 2010). Clay minerals are naturally abundant alumina-silicates that often occur as deposits in many parts of the world (Awokunmi and Asaolu, 2017). They are found in nature either as large or small deposit covering of the earth surface. They form a major part of soils in which plants grow and they are the primary raw materials in various industrial products such as adsorbents, cosmetics, pharmaceuticals, paints, veterinary medicine and biocides (Carretero, 2002; Zhant *et al.*, 2007; Adekeye *et al.*, 2019). Both raw and modified clay minerals as well as materials synthesized from minerals such as kaolinite and steatite have long been used in many parts of the world to treat several human diseases and ailments including those of the digestive tract (Ferrell, 2008).

The diversity of clay mineral applications can be attributed to their chemical, geotechnical, and biological characteristics. Clay minerals consist of various elements including the transition metals (Adekeye *et al.*, 2019). These elements may either be beneficial or toxic to microorganisms. Some elements may serve as sources of minerals for various biological functioning while others may be toxic to the organisms (Prescott *et al.*, 1999; Li, 2002; Morrison *et al.*, 2014). Chemical nature of clay minerals greatly influences the type of microorganism that can inhabit the minerals phyllosphere and environment. The chemical and geobiological properties of clay minerals mediate the interactions between clays and microorganisms, giving rise to diverse mechanisms of interactions. Clay minerals are known to be biocidal in nature and are capable of inhibiting several microorganisms. Mineral pH, presence of metals and metal ions, ion exchange and adsorption properties are common factors that promote inhibition of microorganisms (Sparling and Lowe, 1996; Wu *et al.*, 2014). Clay minerals have been widely applied in the field of biomedical science most especially in the areas of drug delivery system, healing of various kinds of disease and ailments, source of dietary supplements, dermatology and in drug formulations (Schiffenbauer and Stotzky, 1982; Choy *et al.*, 2016).

Clay minerals are usually employed in drug formulations in order to increase drug solubility, stabilize photo-unstable drugs under ultraviolet radiation, and retard the release rate (Ito *et al.*, 2001; Shaikh *et al.*, 2007). They are thus considered biomaterials with mild biological activities. Clay mineralogy has been studied for several years by many researchers which have led to advances in their applications. Recent advances in characterization and mineralogical evaluation of clay has led to the general classifications of clay minerals into three based on layer types (Brady, 1990). This is also discussed in the recent work reported by (Adekeye *et al.*, 2019), on physicochemical and mineralogical evaluation of a Nigeria clay mineral. The classification of clay minerals is based upon the number and arrangement of tetrahedral and octahedral sheets in the basic structures of clay minerals. They are: 1:1 (e.g. kaolinite), 2:1 (e.g. smectite and vermiculite groups) and 2:1:1 (e.g. chlorite) clay minerals (Brady, 1990). Instrumentation in characterization and mineralogical evaluation of clay has also enabled and enhanced the grouping of clay minerals into five. They are: Kaolinite, illite, chlorite, smectite and vermiculite (Mohammad, 2017). Clay minerals are composed of hydrous aluminium layer silicates with structures similar to those of micas (Grim, 1962). Unlike the micas, however, interlayers of clay minerals contain a low cationic charge that binds adjacent silicate sheets and can allow free flow of water molecules through the interlayer regions (Fu and Wang, 2011). The arrangement of chemical components of clay minerals is responsible for their different chemical characteristics which include plasticity, ion exchange and adsorption (Hongo *et al.*, 2012). The plasticity, ion exchange and adsorption characteristics of clay minerals differ from minerals to minerals (Ferrell, 2008).

Humans have used clay for medicinal purposes since prehistoric times, and this practice is now being considered for adoption into the biomedical compendium. A recent report described the application of French green clay to Buruli ulcers, resulting in apparent activity against *Mycobacterium ulcerans* and wound re-epithelialisation (Morrison *et al.*, 2017; Williams, 2004). When clay containing reduced transition metals is taken from its natural environment and mixed with oxygenated water, soluble metals from the minerals likely provide aqueous reactants that drive an antibacterial process (Morrison *et al.*, 2016). Infectious diseases show an important health problem and represent one of the main causes of mortality worldwide, due to the indiscriminate use of antibiotics and incidence of multiple



**Priya and Sangeetha**

antibiotic resistances in human pathogens. Due to report of increasing developments of drug resistance in human pathogen, it is necessary to search for new agents which are better and without side effect for treating diseases especially in developing countries. Antimicrobial activity of Acacia was reported to be concentrated either in leaves or bark and their extracts have been reported inhibitory against *Streptococcus viridans*, *Staphylococcus aureus*, *Escherichia coli*, *Salmonella Typhi*, *Bacillus subtilis*, *B. Creus*, *Shigellasonnei* and even against *Candida albicans*, *C. Glabrata* and *Aspergillus niger* and *Rhizoctonia solani* (Baravkar *et al.*, 2008; Banso, 2009; Sharma *et al.*, 2014; Lawrence *et al.*, 2015; De *et al.*, 2014; Chatterjee and Das, 2014). The antimicrobial activity has been chiefly detected in methanolic extracts rather than in aqueous extract (Chatterjee and Das, 2014). Also, Kaolin base nanocomposites (Hindi *et al.*, 2015) and gum Arabic ethanolic extracts were found be effective against bacteria isolates (Sylva *et al.*, 2016).

The use of antibiotics and chemotherapeutic agents during the past century represents one of the greatest advances in human health and has led to a remarkable reduction of morbidity and mortality related to bacterial infections. In modern medicine, antibacterial, antimicrobial and chemotherapeutic agents are terms used to describe chemical agents effective at treating infection diseases. Most of these agents are antibiotics, which by definition are low molecular weight byproducts of microorganisms that kill or inhibit the growth of other and susceptible microorganisms. The majority of known antimicrobials function by affecting cell wall synthesis, inhibiting protein and nucleic acid synthesis, disrupting membrane structure and function, and inhibiting key enzymes essential for various microbial metabolic pathways (Menichetti, 2005; Shah, 2005; Sharma *et al.*, 2005; Zetola *et al.*, 2005). Aim of the present study was designed to evaluate the antimicrobial potential of Kaolinite, Bentonite, Pyrophyllite and Local clay against *Pseudomonas aeruginosa*, *Staphylococcus aureus* and *Aspergillus flavus*.

## MATERIALS AND METHODS

### Materials

Kaolin, bentonite, pyrophyllite clays were obtained from Indian clays limited, Thiruvananthapuram and the Local clay were collected from our area. *Pseudomonas aeruginosa* (gram-negative), *Staphylococcus aureus* (gram-positive), *Aspergillus flavus* were grown in the Kirby-Bauer Method (Scudder Diagnostic Centre).

### Methods

#### Antimicrobial Activities

*Pseudomonas aeruginosa* (gram-negative), *Staphylococcus aureus* (gram-positive), *Aspergillus flavus*, were used in this study the Kirby-Bauer method.

#### The Kirby-Bauer Method (1966)

The medium is prepared and sterilised as directed by the manufacturer. Defibrinated blood may be necessary for tests on fastidious organisms, in which case the medium should be allowed to cool to 50° C before 7% of blood is added. Human blood is not recommended as it may contain antimicrobial substances; the medium should be poured into Petri dishes on a flat horizontal surface to a depth of 4 mm (25ml in an 85 mm circular dish, 60ml in a 135 mm circular dish). Poured plates are stored +4° C and used within one week of preparation. Before inoculation plates should be dried with lids ajar so that there are no droplets of moisture on the agar surface. The time to achieve this depends on the drying conditions. The pH of the medium should be checked at the time of preparation and should be 7.2 to 7.4 (Bauer *et al.*, 1966).

## RESULTS

The results of the antimicrobial activity test indicate that the clay sample suppresses the growth of the bacterial population but after 24 hours there is inevitably an increase in the bacterial population. The figure shows the antimicrobial activity of K, L, B and P clays in a sterile environment and performed against three bacterial strains of clinical interest: *Pseudomonas aeruginosa* 18mm *Staphylococcus aureus* 14mm. The images show the absence of bacteria,

37848



**Priya and Sangeetha**

demonstrating that there was no risk of bacterial contamination in any of the clays studied that may compromise the system, making them biologically safe and without antimicrobial activity. The same results were obtained in (Gamoudi and Srasra, 2017; Favero *et al.*, 2016; cavalcantiet *al.*, 2014), using cosmetic formulations based on bentonite clays. In recent studies in the literature, the inhibition of bacterial growth by clay specimens was reported (Londono *et al.*, 2017; Morrison *et al.*, 2016). In this work, the anti fungal activity of the extraction, Kaolin and other clays were tested against *Aspergillus flavus*. For *Aspergillus flavus*, as the concentration of extract and kaolin were decreased from 15mm to 10mm respectively (Table1). This phenomenon of the increased in concentration of antifungal agents with increases in the diameter of the inhibition zone was reported by some authors (Hosseinzadeh, 2016; Kulatunga *et al.*, 2017; Kauret *al.*, 2012; Dubey *et al.*, 2015; Singh *et al.*, 2015; Bnuyan *et al.*, 2015; Banjaret *al.*, 2017; Lanzilotto *et al.*, 2018; Dedkovak *et al.*, 2012; Mariselvi and Alagumuthu, 2015; Holesovaa *et al.*, 2016; Shehuet *al.*, 2018). Among the three antifungal agents, the extract had the highest inhibition against the fungi, followed by kaolin / other clay minerals. The inhibition zone of Nystatin (control) against *Aspergillus flavus* was medium than that of the other antifungal agents (Kaur *et al.*, 2012).

**DISCUSSION**

As clay is a mineralogical substance, through understanding of the material is necessary before material use. Toxic metals (eg. As, Hg) protected within certain clays may become captivated through the integumentary barrier. Many types of clay do not reduce bacterial populations; they may either be innocuous or actually enhance bacterial growth (Williams *et al.*, 2004). The bactericidal mechanism was not due to the physical attraction between clay and bacteria, thus suggesting a chemical transfer or reaction. It was found that the PH and the oxidation state, buffered by the clay minerals through the cationic exchange at the clay surface arte key to controlling the solution chemistry and redox reaction occurring at the bacterial cell wall (Williams and Haydel, 2010). A group of investigators suggest that the curing power may be attributed to the antibiotic-producing bacteria they have found living in the soil (Falkinham *et al.*, 2009). To assess the effect of the clays minerals on the growth of clinically relevant Gram-negative and Gram positive bacteria, susceptibility testing of *Staphylococcus aureus* and *Pseudomonas aeruginosa* was performed in liquid cultures. To achieve poultice consistencies similar to those used to treat skin Infection patients, initial bacterial cultures ( $10^7$  bacteria / 400ML) were mixed with 200mg of clay minerals and incubated at 37°C for 24 hours (Shelley *et al.*, 2008). In the present study three out of four mineral clays (Kaolinite clay, bentonite clay, pyrophyllite clay and Local clay) were seen to have a good bactericidal effect against Gram-positive bacteria, other hand pink mineral clay demonstrated a bacteriostatic effect against the same bacteria, and has a bactericidal effect against Gram-negative bacteria stated that bentonite may provide a natural pharmacy of anti bacterial agents (Lynda *et al.*, 2009).

**CONCLUSION**

The present study indicates that mineral clay could provide an alternative action against numerous human bacterial infections. The growing interest in the microbial connections with organic clay minerals is related to the huge significance of this vast and ubiquitous phenomenon, which has greatly influenced the shaping of the evolution of the biosphere, and has important environmental and biotechnological implications.

**REFERENCES**

1. Awokunmi, E.E. and Asaolu, S.S. 2017. Physicochemical and performance evaluation of natural and modified Ire-Ekiti clay. Emerging substrate in the de-fluoridation of drinking water. Journal of physical and chemical sciences,5(4): 2348-3270.
2. Adekeye, D., Popoola, O., Asaolu, S., Ibigbami O. and Olatoye, A. 2019. Physicochemical Characterization and Mineralogical Evaluation of Ire- Ekiti Clay deposit in Southwestern Nigeria. International Journal of Engineering Applied Sciences and Technology,4(8):94-99.





**Priya and Sangeetha**

3. Adekeye, D.K., Asaolu, S.S., Adefemi, S.O., Ibigbami, O.A., Adebawore, A.A. 2019. Clay Soil Modification Techniques for the Adsorption of heavy Metals in aqueous Medium. A Review. International Journal of Advanced Research in Chemical Sciences,6(6): 14-31.
4. Abrahams, P.W. 2012. *Appl. Geochem.*,27: 954.
5. Bauer, A.W., Kirby, W.M.M., Sherris, J.C. and M. Turck. 1966. Antibiotic.
6. Bech, J. 1987. Discurs. Reial Acad. Farmacia Barcelona. CIRIT. Barcelona,105.
7. Benotto, D.M. 2006. Geoquímica do urânio aplicadaaguas minerals. UNESP.
8. Brady, N. 1990. Soil Colloids. Their Nature and Practical Significance. The Nature and Properties of Soils. (10th Edi.). Macmillan Publishing Co. New York, 177-212.
9. Baravkar, A.A., Kale, R.N., Patil, R.N. and Sawant, S.D.2008. Pharmaceutical and biological evaluation of formulated cream of methanolic extract of *Acacia nilotica* leaves. *Res. J. Pharm, Technol.*,1(4): 481-483.
10. Bansa, A. 2009. Phytochemical and antibacterial investigation of bark extracts of *Acacia nilotica*,*J. Med Plants Res.*,3(82).
11. Bnuyan, I.A., Hindi N.K.K., Jebur, M.H., and Mahdi, M.A. 2015. In vitro Antimicrobial Activity of Gum Arabic (Al Manna and Tayebat) Probiotics against Infectious Pathogens. *Ijppr.Human*, 3(3): 77-85.
12. Banjar, M.M., Khafaji, A.M. and Maher Y.A. 2017. Antimicrobial Activity of Hydrogen Peroxide. Sesame and Gum Arabic against *Streptococcus Mutans*. *Int. J. of Health Sci. &Res.*,7(1): 97-104.
13. Cavalcanti, R.K.B.C., Brasileiro, C.J., Macedo, R.O., Ferreira, H.S. 2018. *Ceramica*, 64: 370, 260.
14. Carretero, M.I. 2002. Clay minerals and their beneficial effects upon human health. A review. *Applied clay science*,21:155-163.
15. Carretero, M.I., Gomes, C.S.F. and Tateo, F. 2006. Clay and human health. In. Bergaya F., Theng, B.K.G: Lagaly G. Editors. Handbook of clay science. Elsevier Ltd.
16. Carretero, M.I. 2002. Clay minerals and their beneficial effects upon human health. A review. *Applied Clay Science*,21(3-4): 155-163.
17. Choy, J., Kim, M.H., Choi, G., Elzatahry, A., Vinu, A. 2016. Review of Clay-Drug Hybrid Materials for Biomedical Applications. Administration Routes. *Clays and Clay Minerals*,64(2): 115-130.
18. Carretero, M., Gomes, C., Tateo, F. 2013. Clay drugs and human health. *Developments in clay science*. Elsevier, 711.
19. De, K., Dev, S.N.C. and Singh, S. 2014. Antimicrobial activity and phytochemical analysis of *Acacia nilotica* (L.) Del., *Indian J. Applied & Pure Bio.*,29(2): 331-332.
20. Dubey, S., Sinha, D.K., Murugan, M.S., Singh, P.L., Siddiqui, M.Z., Prasad, N., Prasanna, V.A., Bhardwaj, M., Singh, B.R. 2015. Antimicrobial Activity of Ethanolic and Aqueous Extracts of Common Edible Gums against Pathogenic Bacteria of Animal and Human Health Significance. *Research & Reviews. J. of Pharm. and Nanotech.*,3(3): 30-36.
21. Dedkova, K., Peikertova, P., Matejova, K., Lang, J. and Kukutschova, J. 2012. Study of the Antibacterial Activity of Composites Kaolinite/TiO<sub>2</sub>. *Nanocon.*, 23-25.
22. Ferrell R.E. 2008. Medicinal clay and spiritual healing clays. *Clayminer.*,(56): 751-760.
23. Fu, F., Wang, Q. 2011. Removal of heavy metal ions from wastewaters, A review. *Journal of Environmental Management*, 92(3): 407-418.
24. Falkinham, J.O. 3<sup>rd</sup>, Wall, T.E., Tanner J.R., Tawaha K., Alali F.Q., Li C., Oberlies N.H. 2009. Proliferation of antibiotic producing bacteria and concomitant antibiotic production as the basis for the anti biotic activity of Jordan's red soils. *Applied and environmental microbiology*,75, 2735, DOI : 10, 1128 / AEM. 00104-09.
25. Favero, J.S., Parisotto-Peterle, J., Weiss, V., Angeli, Brand alise, R.N., Gomes, L.B., Bergmann, C.P., Dos santos, V. 2016. *Appl. clay Sci.*,253: 124-125.
26. Gamoudi, S., Srasra, E. 2017. *Appl. clay. Sci.*,146: 162.
27. Galan, E., Carretero, M., Fernandez, J., Caliani, 1999. *Clay Miner.*,34(99).
28. Gomes, C.S.F., Silva, J.B.P. 2007. *Appl. clay sci.*,36(4).
29. Grim, R.E. 1962. *Applied Clay Mineralogy*. McGraw Hill Press.
30. Hongo, T., Yoshino, S., Yamazaki, A., Satokawa, S. 2012. Mechano-chemical treatment of vermiculite in vibration milling and its effect on lead (II) adsorption ability, *Applied Clay Science*,70: 74-78.





**Priya and Sangeetha**

31. Hindi, N.K., Bnuyan, J.A., Jebur, M.H. and Mahdi M.A. 2015. In Vitro Antimicrobial Activity of Gum Arabic (Al Manna and Tayebat) Prebiotics against Infectious Pathogens, *Ijppr. Human.*,3(3): 77-85.
32. Hosseinzadeh, H. 2016. Microwave-Assisted Synthesis of Kappa-Carrageenan Beads Containing Silver Nanoparticles with Dye Adsorption and Antibacterial Properties, *J. Nanostruct.*,6(2): 132-139, DOI: 10.7508/jns.2016.02.005.
33. Holesovaa, S., Hundákováa, M. and Pazdziora E. 2016. Antibacterial kaolinite based nanocomposites. *Procedia Materials Science*,12: 124-129.
34. Ito, T., Sugafuji, T., Maruyama, M., Ohwa, Y., Takahashi, T. 2001. Skin penetration by indomethacin is enhanced by use of an indomethacin/ smectite complex. *Journal of Supramolecular Chemistry*,1: 217-219.
35. Kulatunga, D.C.M., Dananjaya, S.H.S., Godahewa, G.I., Lee, J. and De Zoysa, M. 2017. Chitosan Silver Nanocomposite (CAgNC) as an Antifungal Agent against *Candida albicans*. *Med.Mycol.*,51: 213–222, DOI: 10, 1093/mmy/myw053.
36. Kaur, P., Thakur, R. and Choudhary A.2012. An In Vitro Study of the Antifungal Activity of Silver/Chitosan Nanoformulations against Important Seed Borne Pathogens. *Int. J. of Sci& Tec Res.*,1(6): 83-86.
37. Li, B. 2002. Antibacterial vermiculite nano-material. *Journal of the Minerals Metals and Materials Society*, 1: 61-68.
38. Lawrence, R., Jeyakumar, E. and Gupta, A. 2015. Antibacterial Activity of *Acacia Arabica* (Bark) Extract against selected Multi Drug Resistant Pathogenic Bacteria. *Int. J. Curr, Microbiol, App, Sci.*,SI-1: 213-222.
39. Londono, S.C., Hartnett, H.E., Williams, L.B. 2017. Antibacterial activity of aluminium in clay from the Colombian amazon, *Environmental Science & Technology*, 51(4): 2401-2408.
40. Lanzilotto, A., Kyropoulou, M., Constable, E.C., Housecroft, C.E., Meier, W.P. and Palivan, C.G. 2018. Porphyrin-polymer Nano compartments, Singlet Oxygen Generation and Antimicrobial Activity. *JBIC J. of Biol Inorganic Chem.*,23: 109–122. <https://doi.org/10.1007/s00775-017-1514-8>.
41. Lynda, B.W., Shelley, E.H. and Ray, E.F. 2009. Bentonite, Band-aids, and Borborygmi, *Mineralogical society of America*,5(2): 99-104.
42. Moraes, J.D.D., Bertolino, S.R.A., Cuffini, S.L., Ducart, D.F., Bretzke, P.E., Leonardi, G.R. 2017. *Int.J.Pharm.*,534: 213.
43. Moor, D.M., Renolds, R.C, 1997. X-ray diffraction and the identification and analysis of clay minerals. Newyork. Oxford University press.
44. Morrison, K.D., Underwood, J.C., Metge, D.W., Eberl, D.D., Williams, L.B. 2014. Mineralogical variables that control the antibacterial effectiveness of natural clay deposit. *Environ Geochem Health.*,36(4): 613-631.
45. Moberly, J.G., Staven, A., Sani, R.K., Peyton, B.M. 2010. Influence of pH and inorganic phosphate on toxicity of zinc to *Arthrobacter sp.* isolated from heavy-metal-contaminated sediments. *Environmental Science & Technology*,44: 7302-7308.
46. Mishra, B.B., Richa, R. 2015. Soil Science Vs Science for Medicine. *EC Agriculture*,2(5): 454-461.
47. Mohammad, K.U. 2017. A review on the adsorption of heavy metals by clay minerals with special focus on the past decade. *Chemical Engineering Journal*,308: 438-462.
48. Morrison, K.D., Williams, S.N., Williams, L.B. 2017. The anatomy of an antibacterial clay deposit. A new economic geology. *Econ Geol.*,112: 1551–1570.
49. Morrison, K.D., Misra, R., Williams, L.B. 2016. Unearthing the antibacterial mechanism of medicinal clay. A geochemical approach to combating antibiotic resistance. *Sci Rep.*,6: 19043.
50. Menichetti, F. 2015. Current and emerging serious Gram-positive infections. *Clinical Microbiology and Infection*,11: 22-28, PubMed, 15811021.
51. Morrison, K.D., Misra, R., Williams, L. B. 2016. Unearthing the antibacterial mechanism of medicinal clay, a geochemical approach to combating antibiotic resistance, *Scientific Reports*,6: 19043.
52. Mariselvi, P. and Alagumuthu G. 2015. Structural. Morphological and Antibacterial Activity of Kaolinite/TiO<sub>2</sub>Nanocomposites. *J. Nanosci, Tech.*,1(1): 16-18.
53. Necip, G. 2009. Bentonite clays for molecular engineering, *Mineralogical society of America*,5(2): 89-92.





**Priya and Sangeetha**

54. Parolo, M.E., Fernández, L.G., Zajonkovsky, I., Sánchez, M.P., Baschini, M. 2011. Antibacterial activity of materials synthesized from clay minerals Science against microbial pathogens. Communicating current research and technological advances, 144-151.
55. Prescott, L., Harley, J., Klein, D. 1999. Microbiology (4th Edi.), McGraw Hill. New York.
56. Santos, P.S. Edgard Blucher, Paulo, S. 1989. Ciencia e tecnologia de argilas.
57. Sparling, D.W., Lowe, P., 1996. Environmental hazards of aluminium to plants. Invertebrates, fish, and wildlife. In: Ware GW, Gunther FA (Eds.), Reviews of Environmental Contamination and Toxicology. Springer. New York, 1-127.
58. Santo, C., Lam, E., Elowsky, C., Quaranta, D., Domaille, D. 2011. Bacterial killing by dry metallic copper surfaces. Applied and Environmental Microbiology, 77: 794-802.
59. Schiffenbauer, M., Stotzky, G. 1982. Adsorption of coliphages T1 and T7 to clay minerals. Applied and Environmental Microbiology, 43(3): 590- 596.
60. Shaikh, S., Birdi, A., Qutubuddin, S., Lakatos, E., Baskaran, H. 2007. Controlled release in trans dermal pressure sensitive adhesives using organ silicate nanocomposites. Annals of Biomedical Engineering, 35: 2130-2137.
61. Sharma, C., Kamal, R.A. and Parveen, S. In vitro evaluation of anti-microbial spectrum of Acacia nilotica leaves and bark extracts against pathogens causing otitis infection. *J Inno Biol*, 1(1): 51-60, 2014.
62. Sylva, H., Marianna, H. and Erich P. 2016. Antibacterial kaolinite based nanocomposites. Procedia Materials Science, 12: 124-129.
63. Shah, P.M. 2005. The need for new therapeutic agents. What is the pipeline? Clinical Microbiology and Infection, 11: 36-42, PubMed. 15900655.
64. Sharma, R., Sharma, C.L., Kapoor, B. 2005. Antibacterial resistance. Current problems and possible solutions, Indian Journal of Medical Sciences, 59: 120-129. PubMed, 15805685.
65. Singh, B.R., Dubey, S. and Siddiqui MZ. 2015. Antimicrobial Activity of Natural Edible Gums. *World J Pharm Sci*, 3(11): 2217-2221.
66. Shehu, Z., Danbature, W.L., Maisanda, A.S. and Musa, M.S. 2018. Synthesis. Characterization and Antibacterial Activity of Kaolin/Gum Arabic Nanocomposite on *Escherichia Coli* and *Pseudomonas Aeruginosa*. *Res J. of Nanosci and Eng*, 2(2): 23-29.
67. Shelley, E.H., Christine, M.R. and Lynda, B.W. 2008. Broad-spectrum in vitro antibacterial activities of clay minerals against antibiotic susceptible and antibiotic-resistant bacteria pathogens. *J. Antimicrobial chemother*, 61(2): 353-361.
68. Stotzky, G. 1996. Influence of clay minerals on microorganisms, Effect of various clay species. homoionic clays and other particles on bacteria. *J. Microbial*, 12(4): 831-848.
69. Vieira, C.M.F., Monteiro, S.N. 2003. *Ceramica*, 49: 309(6).
70. Veniale, F. 1997. Guida alla definizione di caratteristiche e proprietà per gli usi industriali. AIPEA. Rimini, 205.
71. Wilson, M.J. 2003. Clay mineralogical and related characteristics of geophagic materials. *Journal of chemical Ecology*, 29: 1525-1547.
72. Williams, L.B., Ltaydel, S.E. 2010. Evaluation of the Medicinal use of clay Minerals as Antibacterial Agents, *International Geology Reviews*, 52 (7/8): 745-770, doi:10.1080/00206811003679737.
73. Wu, H., Chen, W., Rong, X., Huang, Q. 2014. Adhesion of *Pseudomonas putida* onto kaolinite at different growth phases. *Chem Geol*, 390: 1-8.
74. Williams, L.B., Holland, M., Eberl, D.D., Brunet, T., De Courssou, L.B., 2004. Killer clays! Natural antibacterial clay minerals. *Mineralogical Society Bulletin*, 3–8.
75. Xu, G.N., Qiao, X.I., Qiu, X.L., Chen, J.G. 2011. Preparation and characterization of nanosilver loaded montmorillonite with strong antibacterial activity and slow release property, *J Mater Sci Technol*, 27: 685-90.
76. Zhang, G., Kim, J.W., Dong, H., Sommer, A.J. 2007. Microbial effects in promoting the smectite to illite reaction: Role of organic matter intercalated in the interlayer. *A Mineral*, 92: 1401-1410.
77. Zetola, N., Francis, J.S., Nueremberger, E.L., Bishai, W.R., 2005. Community-acquired methicillin-resistant *Staphylococcus aureus*, an emerging threat, *Lancet Infectious Diseases*, 5: 275-286. PubMed. 15854883.



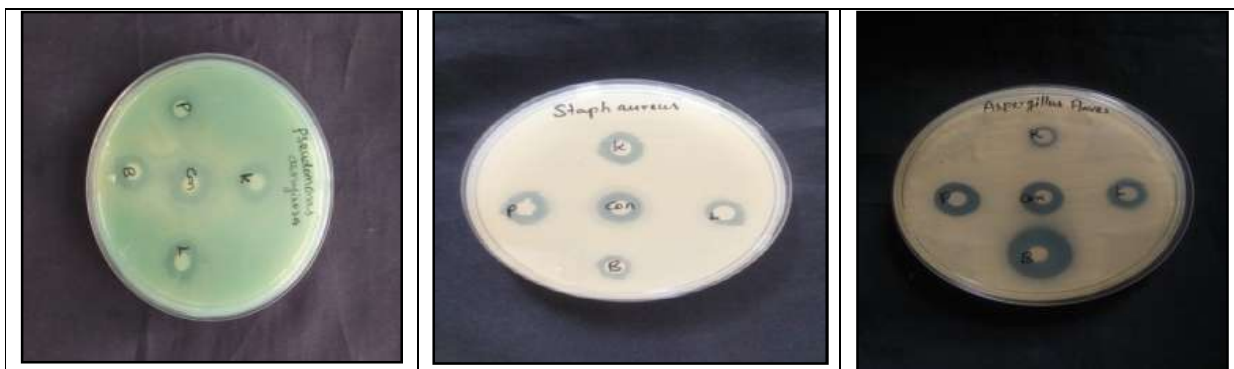


**Priya and Sangeetha**

**Table 1 – Antimicrobial Effect of Selected Clays Used**

S. No.	Micro Organisms used	K	L	B	P	Control
1.	<i>Pseudomonas aeruginosa</i>	15mm	16mm	14mm	10mm	18mm
2.	<i>Staphylococcus aureus</i>	15mm	14mm	12mm	15mm	14mm
3.	<i>Aspergillus flavus</i>	10mm	14mm	21mm	16mm	15mm

K-Kaolinite clay; L-Local clay; B-Bentonite clay; P-Pyrophyllite clay



**Figure – 3 Antimicrobial activities of K, L, B and P clays**

K-Kaolinite clay; L-Local clay; B-Bentonite clay; P-Pyrophyllite clay; C- Control





## Auditing for Sterile Production Area in Pharmaceutical Industry by GMP Guidance – A Review

V. Manikandan<sup>1\*</sup>, G. Sivakamasundari<sup>2</sup> and R. Vinoth<sup>1</sup>

<sup>1</sup>PG Student, Department of Pharmacy, Annamalai University, Tamil Nadu, India.

<sup>2</sup>Assistant Professor, Department of Pharmacy, Annamalai University, Tamil Nadu, India.

Received: 28 Oct 2021

Revised: 13 Dec 2021

Accepted: 06 Jan 2022

### \*Address for Correspondence

#### V. Manikandan

PG Student,  
Department of Pharmacy,  
Annamalai University,  
Tamil Nadu, India.  
Email: saravanamani481@gmail.com



This is an Open Access Journal / article distributed under the terms of the **Creative Commons Attribution License** (CC BY-NC-ND 3.0) which permits unrestricted use, distribution, and reproduction in any medium, provided the original work is properly cited. All rights reserved.

### ABSTRACT

A formal and independent review or examination is required to determine whether processes or products meet their objectives. The audit will determine whether or not the activities and results are in line with the original plans and that the plans have been successfully implemented. The present study endeavoured to discuss auditing for the sterile production area in the pharmaceutical industry, audit types, scope and reason for auditing, organizational aspects for the sterile production area followed by the auditors' how to be ready for the audit and what the requirements needed for the sterile production area. The above-mentioned aspects were studied as per GMP guidance. The use of auditing was required for continuous product production and commercialization for prolonged period of time. Auditors should create a checklist for validating and inspecting a specific area of the pharmaceutical industry before embarking on an audit mission. As a result of this investigation, this study will be useful for auditing the sterile production area through the preparation of a checklist as per GMP guidance.

**Keywords:** Audit, Sterile Production Area, Checklist, GMP Guidance.

### INTRODUCTION

Audits conducted by a qualified and well-prepared auditor can reveal new opportunities for growth. As a result of the European Directive's implementation, pharmaceutical companies now have more auditor requirements for Supplier Qualification. As a result, other types of audits, in addition to GMP audits, are required to look at health and environmental risks, as well as financial considerations. Auditees who are overburdened may reduce the value of audits. An audit should be viewed as a way to compare what was originally planned with what is currently in place, rather than treating the audit target negatively. At the highest levels of the organisation, changes or new



**Manikandan et al.,**

policies and procedures must be implemented. Ineffectiveness, failure to use a systematic approach, and ignorance of good manufacturing practises, among other things, can result from insufficient auditor training and/or preparation (GMPs). Vendor-commissioned audits were conducted by inept auditors who received poor ratings. APIC Certified Auditors use tools like the Aide Memoire and Audit Report Template to ensure the effectiveness and independence of their audits. These Guidelines explain how to conduct an audit in a timely and effective manner. Before reading this guide, it's a good idea to understand the difference between an "audit" and an "inspection." An "inspection" is a term commonly used in the regulatory context to describe a visit by a regulatory authority representative. An audit is carried out by industry experts who examine a company's internal controls and determine where they can be improved. Industry experts will make recommendations in the APIC report on how to conduct audits as well as how to set up and maintain an effective audit system. Incorporate API GMPs that are compliant with ICH Q7 and Q10 into your quality management system. A group of seasoned industry experts penned this manual. Everything has been taken care of, from the planning to the hosting. Both parties will be better prepared to deal with any conflicts or concerns that may arise during the audit as a result of this guidance. What should you do if you run into problems? This is also taken care of. Standards will be established as a result of the completion of this project, and the importance of audits and inspections will be better understood. In the hands of experts, it has the potential to be a powerful growth tool. All auditors and hosts are expected to be professional [1].

**AUDIT TYPES****General Considerations**

According to a more detailed definition of quality audits, it is "an independent and formal review" of processes or products to determine if they "comply with planned arrangements and whether these arrangements are effectively implemented" or "an appropriate examination to determine whether the desired objectives are achieved". Quality audits are required for companies that want to ensure GMP compliance and inspection readiness. To reduce the total number of audits required, SHE audits can be combined with GMP/quality management system audits. This audit must be thoroughly researched before it can be combined with the others [1,2].

**AUDITS CLASSIFICATION****Internal Audits**

Policies and standards can be checked at the plant, departmental, and project levels using centralised auditing methods. An internal review conducted based on the current legal situation for the sake of completeness.

**External Audits**

After conducting tests on new products and services, companies routinely audit external suppliers and contractors. Check that a vendor follows GMP quality and safety standards before working with them. Suppliers should not be held to customer standards during these audits. These audits typically cover a broader range of topics as well as a more in-depth examination<sup>2</sup>. An external audit compares the authorities' requirements to applicable national and/or international standards. Any additional standards that are requested will be discussed between the auditor and the auditee (for example, internal standards). Audits conducted by a third party can be refined even further. A good quality management system is a common goal because good quality products and services necessitate various levels of good manufacturing practises (e.g., API, raw and/or packaging materials, and third-party registered intermediates). Suppliers and contractors can be approved (and/or qualified) using audits. Service providers, raw material suppliers, and contractors all support on-site API or intermediate manufacturing. While auditing is one way to determine compliance, it is far from the only way [3]. A few steps must be taken in the sterile production area auditing process in order to effectively manage the audit. Planning, gathering background information, creating a checklist, and conducting the audit are the steps (Fig. No. 1). Analysing and presenting findings from the audit and the auditee's response Monitoring progress and taking corrective action, as well as preparing an audit report and other supporting documentation. Fig. 2 shows the auditing schedule in greater detail. This audit schedule explains which activities will be audited and which months will be audited simply and clearly.



**Manikandan et al.,****SCOPE AND REASONS FOR AUDITING**

The goal of auditing is to establish and maintain a solid quality control system. If auditing standards are maintained, the following benefits will accrue to the industry as a whole [4]

- Assessing GMP Compliance Effectively
- Cost-cutting
- Improved outcomes
- Assisting with the development of uniform auditing standards
- Increased public confidence in the company's capabilities
- Inspection preparedness
- Reliability and simplicity of use

**Audits may be conducted for a variety of reasons**

- This substance is used in the production of Human or Veterinarian Medical Products to support the declaration of compliance with ICH Q7 and to evaluate the Manufacturing Authorization Holder.
- As part of the Supplier Qualification process, a pre-approval audit may be required.
- A "startup" audit can be used to evaluate new facilities and manufacturing processes before they go into full production mode.
- Suppliers would be subjected to a "follow-up" audit in order to maintain compliance levels and track progress.
- Because of a quality failure or process deviation, "for cause" audits may be required to investigate and/or prepare for a regulatory inspection.

**ORGANISATIONAL ASPECTS OF STERILE PRODUCTION AREA****Organizational Directives**

An audit's goal should be to find inconsistencies between current practices and requirements, not to impose solutions. Senior management should use auditing to demonstrate regulatory compliance and continuous improvement. In the internal quality audit programme, there should be adequate resources and visible support for agreed-upon corrective measures moving forward on time. The approval of the forward audit schedule by senior management usually ensures that all parties involved adhere to the audit programme to the letter. Management at the top<sup>4</sup>. If management uses audits to rank or rank employees, it's a red flag (e.g., salaries). Due to the auditees' unwillingness to cooperate, this case will be dismissed. Even if the auditor isn't up to date on the latest technology, auditees will believe they are being examined by experts (auditors). Tasks are completed in less time, and the truth is kept hidden. If audit-related activities like planning, implementation, and effective follow-up are formalised, uneven outcomes are less likely. Due to their complementary nature, this will necessitate combining GMP and Quality Management System audits [5].

**The Program of Internal Audit**

A one-year forward audit schedule is required to make the most of the available time and expertise. As a result, it will be better prepared to deal with the unforeseeable. Unannounced audits may appear appealing on paper, but in practice, pre-scheduled audits are more practical because they ensure that all necessary personnel and information are present when the audit is conducted (and are required in cases of suspected fraud). A risk-based approach should be used to determine the frequency and duration of audits. Using auditors from various geographical locations and discipline specialties, auditor expertise and experience synergy can be achieved for subsequent audits of the same activity. It's likely that you'll be eligible for one or more of these benefits. This can also be aided by the use of outside consultants [5,6].

**Factors to be consider when conducting an External Audit**

Internal quality audit functions and the QMS can benefit from unbiased feedback from external auditors. As a result of the increased frequency, suppliers and contractors will be audited more frequently, but the audits will last longer. A two-day audit is recommended due to the disruption, limited resources, and expenses incurred by the audited company. A Manufacturing Authorization Holder should evaluate an API supplier every two to three years,

37856



**Manikandan et al.,**

according to European authorities. Due Diligence inspections of customers' or consultants' activities may be conducted by API companies. If clients so desire, they can conduct internal audits. Companies should have a clear policy in place to deal with external audits, including details such as who is responsible and when. Employees will need training to be able to answer questions from an external auditor<sup>7</sup>. It is standard practise to set up a "control room" when a business is being inspected by the government. Before presenting all supporting documentation to the inspector, an audit coordinator is responsible for notifying departments about audits and double-checking all supporting documentation. Having said that, it's important to keep the following in mind. To avoid misunderstandings and delays during the audit, an agreement should be made ahead of time about what information can be used or distributed later.

**Hosting Audits**

External audits by third parties and regulatory authorities must be effectively managed (or certification bodies). Some organisational considerations to keep in mind are as follows; It's simple to get to important documents (and translated if necessary). The preparations will be overseen by a recently formed "task force". One type of arrangement in a family is a "team" of people who all have different roles and responsibilities (settings) [8]. Senior and/or top management involvement, as well as access to key employees (provide correct partner for discussions). Employees must understand what to expect from their auditor and how to respond. Select a method for distributing internal audit reports (e.g., photographing, video taking, areas not assessable, etc.). At all times, provide an armed bodyguard for the auditor. Before they leave, arrange a farewell meeting for senior/top management. When it comes to the preparation and hosting of such audits, an audit procedure that specifies who is responsible for what is highly recommended [9].

**REQUIREMENTS OF STERILE PRODUCTION AREA AS PER GMP GUIDANCE****Manufacturing of Sterile Products**

For our business, we require sterilisation and depyrogenating equipment. It's also necessary to have filtration equipment. The sterile area and aseptic practises are regularly inspected for viable and nonviable microorganisms using reliable equipment [10]. The sterile area air handling unit runs continuously unless it is shut down for routine maintenance.

**Environmental Monitoring**

A laminar flow hood and HVAC system should be installed in the sterile area to ensure sterility. The final arbiter is quality assurance/quality control (QA/QC), with each validation step being overseen by a different department. Send the validation report to the global QA department as soon as possible for documentation. Monitor the environmental programme in all of the above locations on a regular basis. Non-viable particulate sampling can be used to demonstrate the validity of air and surface sampling how long and at what temperature you incubated your environmental monitoring sample. Was that a wise decision? What about the documentation of test results? Environmental monitoring equipment must be calibrated and maintained [11]. To conduct growth support tests on each lot of nutrient media, standard and validated nutrient media autoclave loads will be used. Make sure nutrient media has been sterilised and stored properly before using it.

**Aseptic Batching Area**

The aseptic batching area should be in the Hygienic Batching Class 10,000 area. As soon as possible, HEPA filters should be installed. Every hour, this filter must filter more air. Before renting, make sure the location can withstand the required humidity and temperature levels (50 percent RH). In the aseptic batching area, all equipment in the laminar flow hoods that comes into contact with the product can be sterilised with hot air or steam. Walls, ceilings, and floors should all be thoroughly cleaned before use because they are all non-porous surfaces. To eliminate the need for doorknobs, install self-closing doors. Make use of completely enclosed and sealed electric motors and lighting fixtures. Employees wearing gloves must use hand sanitizers. Before you start working in the kitchen, make sure the laminar flow hoods and HEPA filters are operational. Double-check the equipment labelling in the batching area.



**Manikandan et al.,**

As proof of sterilisation, filter integrity tests should be documented and kept on file. Run a test on the water used to clean the equipment to ensure it is of high quality. Before using pre-sterilized tanks and hoses, end users should make sure they are safe [12]. At various stages of the manufacturing process, tanks should be labelled with product status indicators. Aseptic procedures are performed in laminated flow hoods. Standard operating procedures should be followed when collecting and testing large numbers of sterile samples. Prior to or concurrently with filling, sampling and testing should be completed. Here's what's left in the large bag after final filtration/sterilization. Always use sterile gas filters and double-check that they're still sterile afterward to be safe. After determining the total bulk yield of the process, make sure to reprocess any leftover batches.

**Filling Rooms**

In the filling room, there should be a 10,000 class. The room should be changed at least once an hour to keep the air fresh. No tampering with the environment is permitted. When it's humid, temperatures can reach 68 degrees Fahrenheit (50 percent RH). In this area, Class 100 air should be used in laminar flow hoods over the product. Sterilize any equipment that could come into contact with the product with hot air or steam for self-closing doors without handles. A system should be in place to notify you and record the information when the humidity or filter pressure in the room changes [11,13]. In product-height laminar flow hoods, Class 100 air at a 90-foot-per-second flow rate is recommended. The stainless steel is recommended for the surface of the laminar flow hood. The receptacle filling line should include a non-hinged, non-shedding subitizable continuous belt or conveyor system, as well as automatic filling and stopping equipment. To test the sanitising agent's effectiveness, use gloved hands. To ensure that HEPA filters and laminar flow hoods are in good working order, they should be thoroughly tested.

**Sanitization of Sterile Rooms**

Clean the floors, walls, and ceilings of sterile rooms on a regular basis. Make a list of all the sanitising agents you'll be using and rotate them before you use them. Before using the sanitising agents, rinse and sterilise them with water after they have dried completely (WFI). Use sanitising agents on everything from the floors to the walls and roofs to keep surfaces clean. Keeping track of these processes in writing is a good idea [14].

**Inspection**

The filled vials should be inspected for flaws such as container defects before packaging and batching. It's crucial to keep track of reprocessed and rejected vials. Vials that have been recalled must be handled according to documented formal procedures. Inspectors should take notes on their findings during the sterile area inspection if they feel it is necessary.

**Terminal Sterilization**

Before releasing the products on the market, test the procedures and ensure that they have been terminally sterilised. Every sterilisation procedure should include the use of this chart. Use the appropriate biological markers when sterilizing [15].

**Packaging**

Packaging lines with semi-automatic or automatic capping equipment are recommended to avoid manual handling. The packaging area should keep track of line clearances. Because of the clear packaging and labelling, you'll know exactly what's inside before you even open the box. The product's status should be labelled on the packaging line at the time of packing. Quality control inspectors should pay close attention to packaging operations and document their findings. To ensure accountability, keep track of how many containers are packed, delivered, and then refilled. It's a good idea to keep track of how you reconcile your accounts. After the cartons have been packaged, the labels are applied, and the results are compared to ensure that everything is in order. Whenever a manufacturing problem threatens to degrade the final product's quality, an alert should be sent to the QA/QC department. Validation and documentation of the aforementioned procedure are required [16].



**Manikandan et al.,**

## CONCLUSION

The auditing of sterile production area is covered by GMP guidelines. The review mainly focused on organizational aspects and audit management requirements necessitating the auditing of the sterile production area. The use of auditing was required for continuous product production and commercialization for prolonged period of time. Auditors should create a checklist for validating and inspecting a specific area of the pharmaceutical industry before embarking on an audit mission. As a result of this investigation, this study will be useful for auditing the sterile production area through the preparation of a checklist as per GMP guidance.

## REFERENCES

1. Active Pharmaceutical Ingredient Committee, "Auditing Guide" cefi; 2016.
2. The Institute of Cost Accounts of India, "Guidance Notes on Internal Audits of Pharmaceutical Industry" 1<sup>st</sup> Edition; July 2021; 1,69.
3. ICH Q7 "Good Manufacturing Practice Guide for Active Pharmaceutical Ingredients", Accessed at <https://www.ich.org/page/quality-guidelines>, 2019.
4. CEFIC/APIC "How to do" Document, Interpretation of the ICH Q7a Guide, Accessed at [https://apic.cefic.org/pub/041214Update\\_How%20to%20do.pdf](https://apic.cefic.org/pub/041214Update_How%20to%20do.pdf), 2016.
5. CEFIC/APIC Quality Management System for Active Pharmaceutical Ingredients Manufacturers, Accessed at [https://apic.cefic.org/pub/191005\\_QMSforAPIsFinal.pdf](https://apic.cefic.org/pub/191005_QMSforAPIsFinal.pdf)
6. EN ISO 9000:2000, "Fundamentals and Vocabulary", Accessed at <https://www.iso.org/standard/29280.html>, 2016.
7. EN ISO 9001:2000, "Quality Management Systems -Requirements", Accessed at <https://www.iso.org/standard/21823.html>, 2013.
8. ISO 9001: 2000 - CEFIC Guidelines for use by the Chemical Industry, Accessed at <https://www.scribd.com/document/151231416/ISO-9001-for-Chemical-Industry>, 2009.
9. EN ISO 10011 Part 1: "Auditing", Accessed at <https://www.iso.org/standard/17940.html>, 2019.
10. EN ISO 10011 Part 2: "Qualification criteria for Quality System Auditors", Accessed at <https://www.scribd.com/document/470619970/Assessment-of-the-ISO-9000-Quality-Management-System-Registrar-Accreditation-and-Supplier-Certification-Processes-pdf>, 2019.
11. EN ISO 10011 Part 3: "Management of Audit Programme", Accessed at [https://global.ihs.com/doc\\_detail.cfm?document\\_name=DIN%20ISO%2010011%2D3&item\\_s\\_key=00310720](https://global.ihs.com/doc_detail.cfm?document_name=DIN%20ISO%2010011%2D3&item_s_key=00310720), 2019.
12. WHO Technical Report Series, No. 823: "Provisional guidelines on the Inspection of Pharmaceutical Manufacturers", 1992
13. PQG: "Pharmaceutical Auditing", Monograph, 1992 Institute of Quality assurance
14. IPEC: "Good Manufacturing Practices Audit Guideline for Bulk Pharmaceutical Excipients", November 1998
15. ICH Q10 "Pharmaceutical Quality System" step 3, Accessed at <https://www.ich.org/page/quality-guidelines>, 2020.
16. EudraLex "Medicinal Products for Human and Veterinary Use: Good Manufacturing Practice" Volume 4; Mar 2007.
17. Zeeshan Nazir, Manufacturing Practice Audit-GMP; 2020;1-34.







**Manikandan et al.,**

**GENERAL CHECKLIST FOR AUDITING IN STERILE PRODUCTION AREA**

**Table No. 1. Checklist for Sterile Production Area [17]**

S. No.	Observation	Compliance			Remarks
		Yes	No	NA	
1	Is there any SOP giving details for activity/ movement in the sterile area?				
2	Verify the suitability of system for sanitization of hands.				
3	Is there the SOP on entry-exit; gowning and de-gowning into the critical area available?				
4	Verify the availability of following records:				
a)	Air pressure differential				
b)	Particulate monitoring				
c)	Temperature				
d)	Humidity				
e)	Microbiological monitoring by settle plate				
5	Are these records available and maintained as per SOPs?				
6	Check the above-mentioned individual records. Are the entries within specifications mentioned in SOP?				
7	Is the controlled copy of MTP pertaining to monitoring by settle plate available to plant person?				
8	Are the location for settle plates identified and the chart/ layout available with plant?				
9	Are the following areas monitored for parameters mentioned in step 4?				
a)	Air-lock to the critical area				
b)	Critical area				
c)	Controlled area				
d)	Entrance in control area				
10	Check the change room number 2 as per class?				
11	Is there any environmental monitoring carried out in this area?				
12	Is there any record maintained for cleaning in this area?				
13	Check separate space specified and identification for fresh inner garment and used garment?				
14	Check disinfectant solution must bear 'use before' label?				





**Manikandan et al.,**

S. No.	Observation	Compliance			Remarks
		Yes	No	NA	
15	Is there any airlock between class D area and unclassified area?				
16	Is there any interlocking provided to avoid contamination?				
17	Is there any SOP to prepare the disinfectant solution in this area?				
18	Is there any environmental monitoring carried out to maintain class D?				
19	Is there any record maintained for monitoring the area at a particular frequency?				
20	Is any microbiological monitoring carried out in this area?				
21	Is any personnel monitoring carried out in class D?				
22	If Yes- are the results recorded?				
23	Is any cleaning record maintained for class D area?				
24	Is cleaning procedure validated?				
25	Is there any drainage sink in class D area?				
26	Is there any sop for sanitize the sink, drainage?				
27	Check the differential pressure of area is under specification limit				
28	Check the door they must be closed automatically by pressure?				
29	Is there any airlock provided between unclassified area and class D area for receiving raw material?				
30	Is there any interlocking provided in airlock?				
31	Is there any insectocutor outside the airlock?				
32	Is there any air curtain outside the door?				
33	Is there any SOP to bring aluminum container, sampling aid, rubber stopper from unclassified area to class D area?				
34	Is there any SOP for cleaning the container?				
35	Check the cracks, crevices, hole in wall, ceiling floor?				
36	Is there any SOP for cleaning the sterilizer?				
37	Is there record maintained for its operation?				





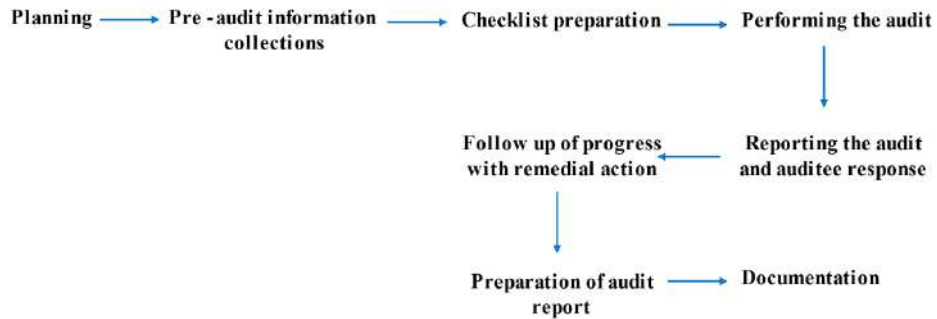
**Manikandan et al.,**

S. No.	Observation	Compliance			Remarks
		Yes	No	NA	
38	Is the adopted method for sterilization validated?				
39	Check loading pattern displayed?				
40	Is any SOP prepared for cleaning the dry heat sterilizer?				
41	Is there loading pattern displayed?				
42	Is there any insectocutor outside the airlock?				
43	Is the adopted method for sterilization in DHS validated?				
44	Is there any SOP for cleaning, sterilization for cartridge filter?				
45	Is the adopted method for sterilization validated?				
46	Is any computerized facility provided for sterilization?				
47	Is computerized equipment validated?				
48	Is there any pass box between the controlled area and aseptic area?				
49	Is there any SOP for handling pass box?				
50	Is adopting process validated for pass box?				
51	Is any environmental monitoring carried out for it?				
52	Is any microbiological monitoring carried out and recorded?				
53	Is there any record for UV light replacement in pass box?				
54	Check the differential pressure of various location of aseptic area. Are they under specification?				
<b>Remarks:</b>					
<b>Auditors Signatures</b>			<b>Auditee Signature</b>		
Sign:	Sign:	Sign:			
Name:	Name:	Name:			
Date:	Date:	Date:			





Manikandan et al.,



Steps in managing the audit

Figure No. 1. Steps in managing the audit

Example of an audit schedule

Month	Jan	Feb	Mar	Apr	May	Jun	Jul	Aug	Sep	Oct	Nov	Dcc
Activity to be audited												
Organization and Management	x											
Staff/Training records		x					x					
Equipment			x					x				
Proficiency programs				x					x			
Test methods					x					x		
calibrations						x					x	
Sample receipt	x											

Figure No. 2. Example of audit schedule





## Brand Awareness and Factors Influence on Digital Marketing to Promote the Products towards Social Media Marketing (SMM)

P.Deivanai\*

Assistant Professor (SS), Department of Commerce, Avinashilingam Institute for Home Science and Higher Education for Women, Coimbatore, Tamil Nadu, India.

Received: 08 Nov 2021

Revised: 15 Dec 2021

Accepted: 10 Jan 2022

### \*Address for Correspondence

**P.Deivanai**

Assistant Professor (SS),

Department of Commerce,

Avinashilingam Institute for Home Science and Higher Education for Women,

Coimbatore, Tamil Nadu, India.

Email: deiva2020p@gmail.com



This is an Open Access Journal / article distributed under the terms of the **Creative Commons Attribution License** (CC BY-NC-ND 3.0) which permits unrestricted use, distribution, and reproduction in any medium, provided the original work is properly cited. All rights reserved.

### ABSTRACT

In today's modern world way of communication is evolving massively. Social media have been a convenient way for all age groups to interact and promote their products. The web platform is a new way to grow the business. Social networking modifies the way sellers and buyers interact. E-trade affects the consumer in his decision to buy. Social media contact is a modern medium for sharing product and service information. Analyse of consumer behaviour, since most of our practice of selling goods and services. Social media is an important way of promoting, selling and surveying goods. Social networking is now an effective promotional marketing device. It is also crucial to consider how social media influences to act as promotion tools. The required data will be collected from primary sources and secondary sources. The study adopts Convenience Sampling Method. The sample size is restricted to 246 customers of Coimbatore district. The customers are classified on the basis of age, gender, income, occupation, family type and qualification. The Primary data were collected from the respondents and are carefully classified, edited and tabulated for this analysis. The result of the analysis shows that social media marketing helps to promote the brand among the customers and how influence and act as promotion tools of the product.

**Keywords:** web platform, consumer, impulse behaviour, networking, brand, promotion.

### INTRODUCTION

Social Media Marketing (SMM) is an easiest way to attract the targeted consumers. In other way social media marketing, it can be defined as the promoting channels particularly product of the company. With this new approach marketing activities of firms have been increased gradually. Numbers of social media sites are there and

37864





### Deivanai

they have different unique features of its own. Whenever we think about social media Face book is the very first thing comes to all of our mind, the other most commonly used are Twitter, LinkedIn etc. Social networking sites help users maintain their current relationships with friends and families, and connect comfortably and efficiently with them. While it was assumed that the role of social websites will reinforce real world dealings, users instead loosen the means of relatives, friends and enlarge their networks to outsiders and stranger. Online networks categorisation like Social websites may be categorized with different positions and functions in an extraordinarily diverse way. Digizen, a corporation categorizes the social network, based on various features. Social network built on profiles. Consumer behaviour based on decision-making procedure and physical movement involved in acquire knowledge, evaluating, using and disposing of product and services.. This study focused on the consumer, social networks focused on accounts are: www.facebook.com and www.myspace.com. The user-developed webpage includes a variety of ways in which they typically contribute to all other areas-usually text, embedded content, links to other content. Some sites allow users to post video links in their profile pages from different sites. Social network built on content: User profile plays a key role in building connections with others. But when compared with content uploading, they have a very small role. The material is mainly in the form of images, and these photographs are discussed by other social network users. Media networks with a white logo: They give their users an ability to create and be part of groups that means that users can build their own customized small website connected to the social network that is important to their subject area. Wet paint is a group-based forum where users are members of this community and are able to produce content on their topic of interest and to interact with others whose topic of interest is the same. These types of categories do not necessarily fall under the social networking overview, but they do play the part of social networking through localized online and offline conversation.

#### Objectives of the Study

The Main objectives of the study are to find out Online Technology and promotion tools – Social Media Marketing (SMM). Based on the main objectives, the following secondary objectives have been framed.

- ❖ To assess the promotional tools utilisation of social media marketing.
- ❖ To offer findings and suggestion to proper utilisation of Social Media Marketing (SMM)

A literature review is a report of the information found in the literature related to a selected area of the study. It is a process of reading, analyzing, evaluating and summarizing scholarly materials about a specific topic. It should give a theoretical base for the research and help the researcher to determine the nature of research. A literature review is more than the search for information, and goes beyond a descriptive annotated bibliography. Hence review of literature is important for any type of research to know the methodology followed and analysis made, identify the research gap in particular. The present chapter shows that what has already been completed related to Social Media Marketing and what work needs to be done. Recent research indicated that duplication of research does not occur. The researcher must classify particular problems from the literature different types of research have been carried out on several aspects of social media marketing. This chapter presents the brief reviews of earlier study based on "Impulse buying behaviour towards Social Media Marketing (SMM) in Coimbatore District". The collection of reviews has been made from various part of the studies undertaken by academic journals, magazines and publications, working papers, books, websites etc., Based on this, the collected reviews are divided into six categories under,

- ❖ Consumers buying behaviour
- ❖ Impulsive buying behaviour
- ❖ Social Media Marketing
- ❖ Factors Influence of Social Media Marketing (SMM) towards Impulse buying
- ❖ Marketing Tendency
- ❖ Marketing Content





## Deivanai

### Source of awareness to know about Social Media Marketing

Social media plays an enormous role in sharing information, there are certain way through consumers can get the information about the social media websites. The details of source of awareness to know about social media marketing given below in the table 1. It revealed from the table 1 that, out of 246 respondents, the majority of 32.11 percentage of the respondents aware about the information through internet advertisement. Followed by 28.86 percentage of the respondents aware about the information through relatives and friends. The next majority of 16.26 percentage of respondents know about their pervious purchase experiences. The next majority of 12.19 percentage of the respondents receive information from magazines and Newspapers. 6.91 percentage of the respondents came to know about social media through company's website. The remaining of 3.65 Percentage of the respondents know about the information through pop up advertising.

### Motivational factors influences to purchase of products through SMM

Promotional tool is an important factor to motivate the products among the customers.. Motivational factors are free gifts, loyalty points, coupons, price discounts, Discount on payment, occasional offers and exchange policy are carried out by various firms. The table 2 explain below. The table 2 exhibit the majority of 29.26 Percentage of the respondents motivated by free gifts and offers. The next majority of 17.07 Percentage of the respondents who has motivated by discounts on payments. Followed by 12.60 percentage of responds motivated by exchange policy. The next 12.19 percentage of the respondents motivated by occasional offers. The next majority of 10.97 Percentage of the respondents motivated by coupons. 10.56 percentages of the respondents motivated by free gifts. 7.31 Percentage of the respondents motivated by loyalty points.

### Platforms of Social Media Marketing (SMM) to promote brands

Social media platforms has vital role playing to development of each business activities. Social media has become a powerful platform to offering product to customers. The important Social media platforms such as, Whatsapp, Face book, Linked in, Instagram, Telegram, Twitter, Messenger, Line, Youtube, Redit, We chat, Viber, Pinterest, Snap chat, Quora. It is depicted from the table 3 whatsapp is used by many more people commonly as a communication tool . The majority of 30.48 percentage of respondents purchase Products through whats app advertising. The next majority of 14.63 percentage of respondents purchase products based on you tube advertising, 12.19 Percentage of the respondents purchase product through Face book advertising. 11.38 Percentage of the respondents purchase product through Linked in platform. 12.19 Percentage of respondents purchase products through Instagram platform.7.72 percentage of respondents purchase products through Telegram platform. 4.87 percentage of respondents purchase product through messenger and snap chat platform. 1.62 percentage of respondents purchase products through Reddit platform.1.21 percentage of respondents purchase product through Quora and Pinterest platform.

### Consumers' opinion about purchase of products through SMM

Product Quality, price, design are some of the basic factors which creates Impulse Buying intention among the consumers likewise, the below table depicts the variables which all increase the impulse buying behaviour of the respondents. It is stated from the Table 4. the "websites design helps to Know about the availability" stands First rank with the percentage score of 3.70. Followed by, familiarity with the new product through social media gets second rank with the 3.69 mean score. Willingness to make impulse buying comes third with 3.58 mean score. Reliability of information in social media advertisements comes fourth with 3.53 mean score. Website search helps to select the products gets the fifth rank with 3.51 mean score. Advertisements in social media are convenient said by 3.47 percentage of the respondents with the seventh rank. Secured payments and attention to ads shown in social media comes to the eighth rank with the mean score of 3.45. Searching of related information about advertisements comes to the tenth rank and the mean score is 3.41. Reliability of advertisements shown in social media comes to eleventh rank with 3.40 mean score. On time delivery in social media purchases gets the least rank with the mean score of 3.05.





### Deivanai

As H<sub>1</sub> revealed that there is a social media marketing (SSM) influence on positive impact on brand promotion buying tendency, it has been confirmed a positive correlations with a significance level at (.003) . It refer that the positive relationship. Therefore, H1 is supported. So Social Media Communication (SMC) there is a positive impact on impulse buying tendency to promote brand. As H<sub>2</sub> exhibits that, there is a Content marketing has a positive impact on impulse buying tendency, it has been confirmed a positive correlations with a significance level at (.002). it is point outs a positive relationship. Therefore, H<sub>2</sub> is supported.

As H<sub>3</sub> explain that, there is a s Social media communication (SMC) has a positive impact on impulse buying, it has been confirmed a positive correlations with a significance level at (.000). point outs a positive relationship. Therefore, H<sub>3</sub> is supported. As H<sub>4</sub> revealed that there is a Content marketing negative impact on impulse buying. it has been confirmed a negative correlations with a significance level at (.104). it point outs a negative relationship. Therefore, H<sub>4</sub> is not supported. As H<sub>5</sub> depicts that there is Content marketing has a positive impact on impulse buying. it has been confirmed a positive correlations with a significance level at (.001). it point outs a positive relationship. Therefore, H<sub>5</sub> is supported. As H<sub>6</sub> exhibits that, there is a Social media communication (SMC) and content marketing (digital marketing) have a positive Impact on impulse buying, it has been confirmed a positive correlations with a significance level at (.000). it is point outs a positive relationship. Therefore, H<sub>6</sub> is supported.

## CONCLUSION

The study conclude that it has been acknowledged that the large number of consumer have been access to Social Media Marketing channels(SMMCs) which fulfilling the personal needs and wants of consumer or professional. The recent Research showed that the effective social media marketing has on potential of laying down have an effect on the behaviour of consumer. Hence, it is essential for the organization to develop their media marketing in such a way that it was able to gain potential knowledge and intention, which affecting the behaviour of consumer by delivery out advertising using, such a website channels. Social media Marketing (SMM), the findings of the study revealed that 78 percentages of respondents used the SSM for sales promotion. The majority of the 69 percentages of the respondent participated on social media platforms. The majority of 80 percent of the respondents were admire the social media marketing and were aged between 30-50 years. These respondents expressed the value of social media reflect on positive attitudes to purchase products and very easy method to get the products at direct to home. Social Media Platforms such as Facebook and Twitter and spent around 4 hours on the internet per day. It create more awareness about the different branded new products and make easy to purchase. The majority of the respondents have an access to the internet and getting idea and knowledge about Social Media Networking collaboration on the social media platforms. The study reveals that satisfaction levels of consumer are seen to be high with respect to Social Media Advertising (SMA) undertaken by consumer. The present study conclude that online technology more suitable the current situation to development of branded product's promotions.

## REFERENCES

1. Ahmed, Raziq, Goreja, The impact of consumer beliefs on consumers' attitude: A social media advertising Perspective, Journal of social sciences and humanities,(2018),26(1),77-104.
2. Ahmed, Raziq, Goreja, The impact of consumer beliefs on consumers' attitude: A social media advertising Perspective, Journal of social sciences and humanities,(2018),26(1),77-104.
3. Bansal, kumar ,Impact of social media marketing on online impulse buying behaviour, Journal of advances and scholarly researchers in allied education. July(2018),15(5),136-139
4. Basariya, lakshmanan, The role of social media on enhancing advertising effectiveness, International journal of Civil Engineering and Technology,(September 2017), 8(9), 1042-1047.
5. Ahmad,Khan, Factors influencing consumers' attitudes toward social media marketing, (march 2017), MIS review22(1/2),21-40.







### Deivanai

6. Kalpanadevi, kiruthika, Impact of web advertising on buying behaviour, E-service; Issues and Challenges, 1(1), ISBN: 978-81-933316-5-1,162-165.
7. Kathiravan, Effectiveness of advertisements in social media, Asian academic research journal of multidisciplinary,(July2017),4 (7),179-190.
8. Al-Zyound, December (2018), Does social media marketing enhance impulse purchasing among female customers case study of Jordanian female shoppers, Journal of Business and retail management research (JBRMR) ,13(2),135-151.
9. Mazhar ali, Shakaib Farid, Effects of personality on impulsive buying behaviour: Evidence from a developing country, Online Resource: <https://mpira.uni-muenchen.de/87401/> posted on 26June 2018.
10. Rahman, Rashid, Social media advertising response and its effectiveness: case of south Asian Teenage Customers, Global Journal of Management and Business Research, 18(4), 2018, 37-44.
11. Bansal, kumar ,Impact of social media marketing on online impulse buying behaviour, Journal of advances and scholarly researchers in allied education. July(2018),15(5),136-139.
12. Kalpanadevi, kiruthika, Impact of web advertising on buying behaviour, E-service; Issues and Challenges, 1(1), ISBN: 978-81-933316-5-1,162-165.

**Table 1. Source of awareness to know about Social Media Marketing (SMM)**

Particulars	No of respondents	Percentage (%)
Company's website	17	6.91
Internet advertisement	79	32.11
Past experience	40	16.26
Newspaper and magazines	30	12.19
Friends and relatives	71	28.86
Pop-up advertising	9	3.65
TOTAL	246	100.00

Source: Primary data

**Table 2. Motivation Factor influence to promote brand through Social Media Marketing**

Particulars	No of Respondents	Percentage (%)
Free gift	26	10.56
Loyalty points	18	7.31
Coupons	27	10.97
Price discounts	72	29.26
Discount on payment	42	17.07
Occasional offers	30	12.19
Exchange policy	31	12.60
TOTAL	246	100.00

Source: Primary data

**Table 3. Platforms of social media marketing**

Factors	No of Respondent	Percentage (%)
Whatsapp	75	30.48
Linked in	28	11.38
Instagram	20	8.13
Face book	30	12.19





## Deivanai

Messenger	10	4.06
Line	1	0.40
Twitter	2	0.81
YouTube	36	14.63
Reddit	3	1.21
Telegram	19	7.72
We chat	2	0.81
Viber	1	0.40
Snap chat	12	4.87
Pinterest	4	1.62
Quora	3	1.21
<b>Total</b>	<b>246</b>	<b>100.00</b>

Source: Primary data

Table – 4. Consumers' opinion about products purchased through SMM

Variables	No of respondents(246)					Total score	Mean score	Rank
	SDA (1)	D (2)	N (3)	A (4)	SA (5)			
I get on time delivery of goods purchased through SMM	37	64	52	34	59	752	3.05	XII
Accurate and reliable information helped me make my purchase decision easier	13	42	59	64	68	870	3.53	IV
I pay attention to advertisement shown in social media	10	54	59	59	64	851	3.45	VIII
I search require and related information's advertisements shown in social media	21	39	62	64	60	841	3.41	X
Advertisements shown in social media are reliable and honest	15	60	53	47	71	837	3.40	XI
I am willing to make Impulsive buying based n Advertisements shown in social media that conveyed information	16	33	58	70	69	881	3.58	III
Advertisements in social media inform me about the latest products available on the market	15	46	56	62	67	858	3.48	VI
Social media advertisements are convenient source of information	15	43	63	60	65	855	3.47	VII
I am familiar with a new brand through social media advertisements	7	42	49	69	79	909	3.69	II
Secured payments encourages	16	48	54	63	65	851	3.45	VIII





**Deivanai**

more people buy through social media applications								
Websites help me in searching and selecting the products while online.	15	49	48	63	71	864	3.51	V
Website design helps me in searching the products easily.	18	38	39	55	96	911	3.70	I

Source: Primary data

**Table 5. Research & validity of Hypothesis**

	<b>Test of Hypothesis</b>	<b>P/F value</b>	<b>Out come</b>
H <sub>1</sub>	Social Media Communication (SMC) there is a positive impact on impulse buying tendency to promote brand	.003	Supported
H <sub>2</sub>	Content marketing has a positive impact on impulse buying tendency to promote brand	.002	Supported
H <sub>3</sub>	Social media communication (SMC) has a positive impact on impulse buying to promote brand	.000	Supported
H <sub>4</sub>	Content marketing has a positive impact on impulse buying to promote brand	.104	Not Supported
H <sub>5</sub>	Impulse buying inclination has a positive impact on impulse buying to promote brand	.001	Supported
H <sub>6</sub>	Social media communication (SMC) and content marketing (Digital Marketing) have a positive impact on impulse buying behaviour to promote brand	.000	Supported





## Evaluation of Tamarind Kernel Powder and its Carboxymethyl Derivative in the Perspective of Formulation Development

Sagar Muley<sup>1\*</sup>, Rahul Trivedi<sup>2</sup> and Tanaji Nandgude<sup>3</sup>

<sup>1</sup>Research Scholar, Department of Pharmacy, B R Nahata College of Pharmacy, Mandsaur University, Mandsaur, Madhya Pradesh, India.

<sup>2</sup>Professor, Department of Pharmacy, B R Nahata College of Pharmacy, Mandsaur University, Mandsaur, Madhya Pradesh, India.

<sup>3</sup>Professor, Department of Pharmaceutics, Dr. D Y Patil Institute of Pharmaceutical Science and Research, Pimpri, Pune, Maharashtra, India.

Received: 08 Nov 2021

Revised: 28 Nov 2021

Accepted: 10 Jan 2022

### \*Address for Correspondence

#### Sagar Muley

Research Scholar,  
Department of Pharmacy,  
B R Nahata College of Pharmacy,  
Mandsaur University, Mandsaur,  
Madhya Pradesh, India.  
Email: sagarsmuley@gmail.com



This is an Open Access Journal / article distributed under the terms of the **Creative Commons Attribution License** (CC BY-NC-ND 3.0) which permits unrestricted use, distribution, and reproduction in any medium, provided the original work is properly cited. All rights reserved.

### ABSTRACT

The main objective of study was evaluation of tamarind kernel powder and its carboxymethyl derivative for better understanding of both the powders which would help in formulation development. Both powders were investigated for their physical and micromeritic properties, true density, solubility in various solvents, pH, swelling index, surface tension, water retention capacity, viscosity, microbial study, differential scanning calorimetry, X-ray diffraction, and scanning electron microscopy in this comparative study. Results clearly indicated that carboxymethyl tamarind kernel powder (CMTKP) is 10 times more soluble in water, having almost doubled water retention capacity, less susceptible to microbial growth and producing more viscous solution when compared with tamarind kernel powder (TKP). Micromeritic properties suggested that TKP has fair and CMTKP have passable flow property. In X-ray diffraction study of CMTKP, characteristic peaks were observed at 31.855 and 45.605 (2-Theta<sup>0</sup>) which indicated the presence of the carboxymethyl group in CMTKP and also suggested its semi crystalline nature. Scanning electron microscopy indicated that surface of CMTKP is smoother than TKP. CMTKP surpasses TKP in terms of solubility, stability, and viscosity. These findings can be utilized in future for formulation development.

**Keywords:** Tamarind kernel powder, Carboxymethyl tamarind kernel powder, Comparative evaluation, Solubility, Viscosity, Microbial study



**Sagar Muley et al.,**

## INTRODUCTION

Tamarind, also known as Imli, is a gum-rich fruit. Tamarind kernel powder (TKP) was first commercially produced in 1943 in India as a substitute for starch in cotton sizing [1]. TKP is a highly branched carbohydrate polymer in terms of its chemical structure. It's a polymer with an average molecular weight of 52350 Daltons made up primarily of glucose, galactose, and xylose in a 3:2:1 molar ratio. Tamarind seeds contain 12.7-15.4 % protein, 37.5 % oil, 7-8.4 % crude fibre, 61-72.2 % carbs, and 2.45-3.3 % ash, indicating that they are a good source of minerals, carbohydrates, proteins, vitamins, fatty acids, amino acids, and other nutrients [2]. The process of making TKP begins with sifting and roasting the seeds. The roasted seeds are placed in a rotary mixer after cooling, where the black testa (20-30% of the seed) is removed, leaving a light brown to white endosperm or kernel. After that, the kernels are placed in a rotary mixer and sliced using a finger cutter. To obtain TKP, the chopped kernels are sorted through a 200-mesh filter after passing through a hammer mill.

### Modifications in of Tamarind kernel powder [2,3]

To achieve various formulations related goals sometimes the following modifications are done in TKP;

#### Carboxymethylation

Carboxymethylation of TKP is carried out under heterogeneous circumstances utilizing mono chloroacetic acid as a catalyst in the presence of an alkali. When compared to the original TKP, this alteration results in increased microbial resistance and viscosity.

#### Degalactosylation

The aggregation of xyloglucan in the polymer is a crucial contributor in gel formation, and this confirmation is almost unaffected by the enzymatic treatment. De-galactosylation of TKP led in enhanced aggregation, which resulted in microgel formation at low concentrations.

#### Thiolation

Thiolation of TKP is accomplished through thioglycolic acid esterification. Thiolation boosts the polymer's bioadhesion and drug permeability. The development of a disulfide link between mucus and thiolatedxyloglucan may be responsible for this enhancement in mucoadhesive properties.

#### Crosslinking with Epichlorohydrin

When TKP is cross-linked with epichlorohydrin, it has a better wicking and swelling effect, making it act like a disintegrant. When compared to TKP without cross-linking, it is also more effective at delaying drug release.

#### Grafting

Grafting is a method in which monomers are covalently attached to a polymer chain and then grafted with synthetic polymers. This process can be used to create a natural product with fewer adverse effects and minimal loss of the original qualities.

## MATERIALS AND METHODS

Tamarind kernel powder (TKP) was obtained from Guru Ganesh Padma Agro Products, Beed, Maharashtra, India and all of the other chemicals and solvents utilised were of the analytical grade.

### Carboxymethylation of TKP

To obtain Carboxymethyl tamarind kernel powder (CMTKP), TKP was carboxymethylated as follows. TKP (0.05 mol) was dispersed in alkaline aqueous methanol (0.16 mol NaOH), then monochloroacetic acid (MCA) was added (0.16 mol). After that, the solution was maintained in a hot water bath at 70 °C for 60 minutes. The solution was then





**Sagar Muley et al.,**

filtered through a G-3 sintered glass crucible before being dissolved in water and neutralised with dilute HCl (1:1 v/v). It was then precipitated with ethanol and washed with aqueous methanol (H<sub>2</sub>O:Methanol:: 20:80) before being washed with pure methanol. The obtained product was then dried, initially at room temperature and finally using vacuum oven maintained at 40 °C for 4 hrs [28].

### Physical properties

TKP and CMTKP were examined for physical properties like color, nature, odor, taste, shape, touch and texture.

### Micromeritic properties

Previously weighed powder ( $W_1$ ) was put in the measuring cylinder and volume ( $V_1$ ) was measured to determine bulk density (BD) and tapped density (TD). Carr's index and Hausner ratio were calculated from bulk and tapped density. The tap density device was used to make tapes, and the tapped volume ( $V_2$ ) was measured [29]. The following formulas were used to perform additional calculations:

$$\begin{aligned} \text{Bulk density} &= \frac{(W_1)}{(V_1)} \\ \text{Tapped density} &= \frac{(W_1)}{(V_2)} \\ \text{Carr's index} &= \frac{(TD - BD)}{TD} \times 100 \\ \text{Hausner ratio} &= \frac{TD}{BD} \end{aligned}$$

The funnel method was used to determine the angle of repose. Powders were poured into a funnel, which formed a pile on a sheet of paper. The pile's radius ( $r$ ) and height ( $h$ ) were both measured. The angle of repose was calculated using the formula below:

$$\tan \theta = \frac{\text{Height of pile formed (h)}}{\text{Radius of pile base (r)}}$$

### True density

At 25 °C, true density was calculated using the liquid displacement method. It is calculated by dividing the weight of the solid material by the weight of the liquid it displaces. In order to measure the density of a material, it must be insoluble in the liquid. The clean, dry 25 ml density bottle's weight ( $W_1$ ) was determined. The bottle was filled with water, the top was dried with filter paper, and the bottle was weighed ( $W_2$ ). As the displacement liquid, benzene was utilised. To determine the weight of the bottle plus benzene, the procedure was repeated using benzene ( $W_3$ ). About 3 g of each sample (TKP and CMTKP) was weighed separately in a dry density bottle ( $W_4$ ). The weight ( $W_5$ ) of the bottle was measured after it was filled with benzene [30]. The formula was used to compute the density of the benzene utilised;

$$\text{Density of benzene } (\rho) = \frac{0.9971(W_3 - W_1)}{(W_2 - W_1)}$$

(0.9971 is water density at 25 °C in g/ml)

The following formula was used to calculate the true density of TKP and CMTKP:

$$\text{Sample's Density} = \frac{(W_4 - W_1)}{\left[ \frac{(W_3 - W_1)}{\rho} \right] - \left[ \frac{(W_5 - W_4)}{\rho} \right]}$$

### Solubility

TKP and CMTKP solubility in various solvents was investigated using a traditional approach [30]. The UV Spectrophotometer was used to determine the aqueous solubility of both TKP and CMTKP. In a beaker holding a fixed volume of water, an excess amount of powder (separately for TKP and CMTKP) was added. The solution was





### Sagar Muley et al.,

filtered, and the filtrate was further diluted with water before being measured using a spectrophotometer at 215 nm [31].

**pH:** Using a pH meter, the pH of a 1 % aqueous solution of TKP and CMTKP was determined [30].

#### Swelling index

10 g of each sample (TKP and CMTKP) were placed individually into a 100 ml stoppered measuring cylinder. The powder's original volume (height;  $H_0$ ) in the measuring cylinder was recorded. With distilled water, the volume was increased to 100 ml. The cylinder was sealed, slightly shaken, and placed away for 24 hrs. After 24 hrs, the volume (height;  $H_t$ ) occupied by the powder sediment was measured. The swelling index (SI) was determined using the following equation and reported as a percentage: [30]

$$\text{Swelling index} = \frac{H_t - H_0}{H_0} \times 100$$

#### Surface tension

Using a stalagmometer, the surface tension of TKP and CMTKP powder solutions in water (0.1 % w/v) was calculated using the drop count method. Above the higher mark, the stalagmometer was filled with water. Water was allowed to fall and the number of drops was counted ( $n_1$ ). The water was withdrawn from the stalagmometer, and similarly drops of TKP and CMTKP solutions were counted individually ( $n_2$ ). The sample's surface tension was calculated using the formula below: [30]

$$\text{Surface tension } (\gamma_2) = \frac{n_1 \rho_2 \gamma_1}{n_2 \rho_1}$$

Where;  $\rho_1$  is 0.9956 g/ml (Density of water),  $\rho_2$  is density of CMTKP and TKP in g/ml,  $\gamma_1$  is 71.18 dynes/cm (surface tension of water)

#### Water retention capacity

Fig. 1 depicts the experimental setup for this experiment. In this setup, a funnel was placed in a graduated measuring cylinder, and the filter paper was placed in a funnel containing an accurately weighed quantity of sample powder. The powder sample was then poured with a predetermined volume of water (100 ml). The water was completely drained. The sample's water retention capacity was calculated using the volume of collected drained water [32].

#### Viscosity

Separate solutions of TKP and CMTKP (1, 3, and 5% concentrations) were prepared with distilled water and stored for 24 hrs to allow swelling. The viscosity was measured with a Brookfield viscometer (DV-E viscometer, Brookfield Engineering Labs) using spindle numbers S61, S62, and S64. The prepared concentration's viscosity was measured at 5, 10, 20, 30, 50, 60, and 100 rpm [12].

#### Microbial study

TKP and CMTKP powder solutions in water (2.5 % w/v) were studied for microbial resistance using nutrient agar medium. In conical flasks, 13 g of nutrient agar was dissolved in 200 ml of distilled water, and the mouth of the conical flask was properly stoppered with a cotton plug. It was then autoclaved for 15–20 min at 121 °C. Then, in an aseptic condition, 20 ml of agar medium was added to a 10 cm diameter petri dish at a temperature of no more than 45 °C. The agar medium was allowed to solidify. The sample solution (0.1 ml and 1 ml) was then spread on the surface of the solidified agar medium. Petri dishes were then incubated for 24 hrs at 37 °C [30].



**Sagar Muley et al.,****Differential scanning calorimetry (DSC)**

TKP and CMTKP samples were processed in differential scanning calorimeter for thermal analysis (Make-Ta Instruments; Model-Q20). 4 mg of sample was placed on a DSC pan and heated at a rate of 15 °C/min between 30 and 350 °C.

**X-ray diffraction(XRD)**

TKP and CMTKP's X-ray diffraction spectra were obtained using an X-ray diffractometer (Make- Rigaku Japan; Model-Smartlab Cu 1.5 KV). The following scanning parameters were used: drive axis (Theta-2Theta), scanning range of 5 to 900, with continuous scan mode, maintaining scan speed of 0.35 deg/min, and scanning at room temperature (25 °C).

**Scanning electron microscopy (SEM)**

A scanning electron microscope (Make-Carl Zeiss Germany; Model-Supra 55) was used to examine the surface morphology of TKP and CMTKP. Double-sided adhesive tape was used to fix the samples to a SEM stub. Under a vacuum, samples were coated with a thin layer of gold. The sample stub was then placed in the SEM chamber, which was set to 10 kV. The images were then captured at various magnifications such as 2, 5, 10, 20, 30, 50, 75, and 100 KX.

**RESULTS AND DISCUSSION****Physical properties**

TKP was observed to be white, odorless, tasteless, irregular in shape and hard and rough in touch and texture. On the other side, CMTKP was observed to be creamy in color, odorless, tasteless, irregular in shape and hard and rough in touch and texture.

**Micromeritic properties**

Table 2 displays the various micromeritic properties of TKP and CMTKP. According to USP specifications, a Hausner ratio of 1.19-1.25 and a Carr's index of 16- 20% indicate fair flow property. The angle of repose between 36-40° and 41-45° indicates that a powder has fair and passable flow properties, respectively. Though official standards are not available for TKP and CMTKP, as per the USP specifications for Hausner ratio and Carr's index, both TKP and CMTKP have fair flow property. In the case of angle of repose, TKP has fair and CMTKP have passable flow property. One should keep in mind these flow properties if they wish to prepare such dosage forms using these excipients in which flow property of the excipient plays an important role. To improve flow property further, glidants may be incorporated in the formulation.

**Solubility**

The solubility of TKP and CMTKP in various solvents was investigated using a conventional method, which revealed that both powders were insoluble in ethanol, acetone, benzene, petroleum ether, n-hexane and isopropyl alcohol. Aqueous solubility of both the powders was studied using UV spectroscopy and the solubility of TKP and CMTKP in water was 7.6 µg/ml and 70 µg/ml respectively. Almost 10 times increase in aqueous solubility clearly indicated that carboxymethylation of TKP further increases the solubility of TKP. In both TKP and CMTKP viscous colloidal solution was formed when solubility in water was studied, relatively more viscous in case of CMTKP. In case of solubility in the water further it can be concluded that solubility of both TKP and CMTKP can be improved by passing powders through a suitable sieve, the addition of small quantity at a time and continue stirring while adding in water.

**pH, swelling index, water retention capacity, and surface tension:**

Both TKP and CMTKP showed alkaline pH of 7.5 and 9.5 respectively. From swelling index and water retention capacity it is clear that CMTKP has more potential for swelling and also a higher capacity of retaining water as compared to TKP. The surface tension for CMTKP was found to be slightly higher than TKP (Table 3).





**Sagar Muley et al.,****Viscosity**

Rheology is the study of matter flow, particularly in a liquid state. Newtonian fluids are fluids made of low molecular weight materials that have a constant viscosity with respect to shear rate (shear stress is directly proportional to the shear rate). Only a few fluids have such consistent viscosity. Non-newtonian fluids are a large class of fluids whose viscosity varies with shear rate. In the case of non-Newtonian fluids, there are primarily two types of behaviour observed: shear-thinning behaviour (pseudoplastic), in which the rate of increase in shear stress with shear rate decreases with increasing shear rate. Shear-thickening behaviour (dilatant) is defined by the rate of increase in shear stress with increasing shear rate [33]. Fig. 2 depicts a graph of the viscosities (cPS; shear stress) of TKP and CMTKP solutions (1, 3, and 5%) versus RPM (shear rate). The graphs show that CMTKP solutions have higher viscosity than TKP solutions. In the case of both powders, the results showed that as the concentration increased, so did the viscosity. In solution, both powders demonstrated non-Newtonian behaviour. Based on the swelling index, water retention capacity, and viscosity study of CMTKP, it can be concluded that this powder can be used as a release modifier in dosage forms.

**Microbial study**

Microbial study of 2.5% w/v solution of TKP and CMTKP using Nutrient agar suggested that in some of the petri dishes of TKP there was microbial growth to some extent (Fig.3). The study suggested that CMTKP is less susceptible to microbial growth as compared to TKP at a given concentration (2.5% w/v). It indicated that as compared to TKP, CMTKP would be safe for use in pharmaceutical dosage forms and there might be no need for the addition of any preservatives in the formulations containing CMTKP. In the case of TKP also very little microbial growth was observed, if anyone decided to use TKP in any formulation then there might be the necessity of incorporating suitable preservatives.

**Differential scanning calorimetry (DSC)**

The DSC thermograms of TKP and CMTKP are shown in fig. 4. For TKP onset started at 164.89°C and ended at 312.63°C. On the other hand, for CMTKP onset started at 158.24°C and ended at 162.40°C. CMTKP thermogram have shown a sharp peak at 160.83°C as compared to a broad peak in the case of TKP at 248.86°C. A sharp peak in DSC thermogram or a clear melting point always helps in studying compatibility studies of a mixture of active pharmaceutical ingredients and excipients of any formulation.

**X-ray diffraction(XRD)**

Overlay X-ray diffraction graph of TKP and CMTKP is shown in fig.5. From this diffraction pattern of TKP and CMTKP, it is clear that both have similar diffraction patterns only the following differences were observed as mentioned in table 4. As there are sharp peaks in both TKP and CMTKP X-ray diffraction graph it indicated that these powders might be semi-crystalline.

**Scanning electron microscopy (SEM)**

The size and shape of the excipient particles may affect the physicochemical properties and biopharmaceutical behaviour of the final dosage forms. Because the influence of shape on flow property, efficient mixing, stability, dissolution, and formulation homogeneity is critical in formulation development, the surface morphology of TKP and CMTKP was characterised using SEM. Fig. 6 depicts SEM images at various magnifications. Agglomerated shapes and irregular particle sizes were observed in both powders, but in the case of CMTKP, they were significantly lower than in the case of TKP. The surface of the CMTKP particle is smoother than that of the TKP, according to SEM photomicrographs. Small particles with less surface roughness and rounded edges were observed in both powders, as were large particles with flat, smooth, irregular, and sharp edges. This could be attributed to the manufacturer's specific grinding technique. These parameters must be considered when developing pharmaceutical dosage forms containing these excipients, especially when the surface morphology of the material is critical. Because of the irregular particle size, uniform mixing may be hampered. This can be rectified by passing these powders through a suitable sieve to aid in uniform mixing



**Sagar Muley et al.,**

## CONCLUSION

Both TKP and CMTKP are versatile excipients and can be utilized as excipients in formulating different dosage forms. The key points which make CMTKP better rather different from TKP are improved water solubility, greater water retention capacity, formation of more viscous solution, stability in terms of less susceptibility to microbial growth. Key differences and findings from the above study will help to select these powders as per the need of formulations. These powders can be used in tablet, granules, pellets formulation as binder and release modifier. In semisolid dosage form like gel it can be used to achieve desired viscosity of formulation. There is also future scope in making novel modifications in the original form of powder to achieve desired effect as per the need

## ACKNOWLEDGEMENT

The authors are very much thankful to B R Nahata College of Pharmacy, Mandsaur, Madhya Pradesh, India for allowing utilizing the facilities for research work.

## CONFLICTS OF INTEREST

The author declares that there are no conflicts of interest regarding the publication of the paper.

## REFERENCES

1. Radha GV, Naidu MS. An overview study on Tamarind seed polysaccharide as a novel excipient in pharmaceutical formulations. *Int J Invent Pharm Sci* 2013;1(2):140–148.
2. Shaikh SS, Shivsharan KJ, Pawar RK, Misal NS, Mene HR, More BA. Tamarind seed polysaccharide: A versatile pharmaceutical excipient and its modification. *Int J Pharm Sci Rev Res* 2015;33(1):157–164.
3. Katiyar N, Malviya R, Sharma PK. Pharmaceutical applications and formulation based patents of tamarindusindica seed polysaccharide and their modified derivatives. *AdvBiol Res* 2014;8(6):274–281.
4. Deveswaran R, Bharath S, Furtado S, Abraham S, Basavaraj BV, Madhavan V. Isolation and evaluation of tamarind seed polysaccharide as a natural suspending Agent. *Int J Pharm Biol Arch* 2010;1(4):360–363.
5. Kumar S, Rao SB, Kulkarni SV. Formulation and evaluation of sustained release matrix tablets of Ambroxol hydrochloride using natural polymer. *Int J Pharm Sci Res* 2014;5(10):4225–4232.
6. Patel AD, Javia A, Seth AK. Development, characterization & optimization of new polymer for the formulation of metformin sustained release tablet. *Int J Pharm Sci* 2013;4(4):68–84.
7. Naiknaware L, Pawar P, Kale S. Design and Characterization of Sustained Release Nevirapine Matrix Tablets Containing Tamarind Seed Polysaccharide. *Am Pharm Heal Res* 2015;3(6):117–124.
8. Ganesan K, Rajaram SK, Chinnathambi A, Murugesan V, Muruganatham K, Amanullah TR, et al. A sustained release of tablet granules associated with ZnSnanocrystals using Tamarind seed polysaccharide. *J Appl Pharm Sci* 2013;3(4SUPPL.1):44–47.
9. Gowda DV, Mahammed N, Vishnu DM. Design and evaluation of carboxymethyl tamarind kernel polysaccharide (CMTKP) controlled release spheroids/pellets and investigating the influence of compression. *Int J Pharm PharmSci* 2014;6(7):103–109.
10. Kulkarni GT, Gowthamarajan K, Dhobe RR, Yohanan F, Suresh B. Development of controlled release spheroids using natural polysaccharide as release modifier. *Drug Deliv* 2005;12(4):201–206.
11. Gowda DV, Mahammed N. Development and evaluation of cross-linked tamarind kernel polysaccharide microspheres as a colon specific drug delivery. *Int J Pharm Sci Rev Res* 2014;27(2):358–363.
12. Razavi M, Nyamathulla S, Karimian H, Moghadamtousi SZ, Noordin MI. Hydrogel polysaccharides of tamarind and xanthan to formulate hydrodynamically balanced matrix tablets of famotidine. *Molecules* 2014;19(9):13909–13931.
13. Chandramouli Y, Firoz S, Vikram A, Padmaja C, Chakravarthi RN. Design and Evaluation of Controlled Release Matrix Tablets of Acyclovir Sodium Using Tamarind. *J Pharm Biol* 2012;2(2):55–62.



**Sagar Muley et al.,**

14. Chandramouli Y, Firoz S, Vikram A, Venkata T, Yasmeen BR, Mahitha B. Evaluation of Tamarind seed polysaccharide (TSP) as a mucoadhesive and controlled release component of Ciprofloxacin HCl mucoadhesive matrix tablet & comparison with HPMC K-100 and Xanthan gum. *Int J Curr Pharm Clin Res* 2012;2(2):90–98.
15. Jangdey MS, Gupta A, Sah AK. Development and evaluation of mucoadhesive sustained release tablet using tamarindusindica gum. *Asian J Res Pharm Sci* 2014;4(2):77–82
16. Jana S, Lakshman D, Sen KK, Basu SK. Development and evaluation of epichlorohydrin cross-linked mucoadhesive patches of tamarind seed polysaccharide for buccal application. *Int J Pharm Sci Drug Res* 2010;2(3):193–198.
17. Satle A, Agrawal S. Solubility enhancement potential of tamarind seed polysaccharide as pharmaceutical excipient. *Int J Curr Pharm Res* 2012;4(4):67–73.
18. Gupta SK, Arora P, Yadav R. Sustained ophthalmic delivery of ketorolac tromethamine from an ion activated in situ gelling system. *Int J Pharm LifeSci* 2014;5(12):4063–4073.
19. Muley SS, Nandgude T, Poddar SS. Formulation and Optimization of Lansoprazole Pellets Using Factorial Design Prepared by Extrusion-Spheronization Technique Using Carboxymethyl Tamarind Kernel Powder. *Recent Pat Drug Deliv Formul* 2017;11(1):54–66.
20. Kumar D, Mundlia J, Kumar T, Ahuja M. Silica coating of carboxymethyl tamarind kernel polysaccharide beads to modify the release characteristics. *Int J BiolMacromol* 2020;146:1040–1049.
21. Agarwal S, Hoque M, Bandara N, Pal K, Sarkar P. Synthesis and characterization of tamarind kernel powder-based antimicrobial edible films loaded with geraniol. *Food Packag Shelf Life* 2020;26(August):1–11.
22. Razavi M, Karimian H, Yeong CH, Fadaeinabab M, Khaing SL, Chung LY, et al. Gastroretentive behavior of orally administered radiolabeled tamarind seed formulations in rabbits validated by gamma scintigraphy. *Drug Des Devel Ther* 2017;11:1–15.
23. Teaima M, Hamid MMA, Shoman NA, Jasti BR, El-Nabarawi MA. Promising swellable floating bupropion tablets: Formulation, in vitro/in vivo evaluation and comparative pharmacokinetic study in human volunteers. *Drug Des Devel Ther* 2020;14:2741–2757.
24. Sharma V, Pathak K. Lquisolid system of paclitaxel using modified polysaccharides: In vitro cytotoxicity, apoptosis study, cell cycle analysis, in vitro mitochondrial membrane potential assessment, and pharmacokinetics. *Int J BiolMacromol* 2019;137:20–31.
25. Crispín-Isidro G, Hernández-Rodríguez L, Ramírez-Santiago C, Sandoval-Castilla O, Lobato-Calleros C, Vernon-Carter EJ. Influence of purification on physicochemical and emulsifying properties of tamarind (*Tamarindusindica* L.) seed gum. *Food Hydrocoll* 2019;93(November 2018):402–412.
26. Rodrigues DC, Cunha AP, Silva LMA, Rodrigues THS, Gallão MI, Azeredo HMC. Emulsion films from tamarind kernel xyloglucan and sesame seed oil by different emulsification techniques. *Food Hydrocoll* 2018;77:270–276.
27. Choudhury P, Chawla S, Agarwal S, Singh A, Nayak A, Kumar A, et al. Modified tamarind kernel polysaccharide-based matrix alters neuro-keratinocyte cross-talk and serves as a suitable scaffold for skin tissue engineering. *Mater SciEng C* 2021;121:1–35.
28. Goyal P, Kumar V, Sharma P. Carboxymethylation of Tamarind kernel powder, *Carbohydr. Polym.* 2007; 69: 251–255
29. Geldart D, Abdullah EC, Hassanpour A, Nwoke LC, Wouters I. Characterization of powder flowability using measurement of angle of repose. *China Particuology* 2006;4(3–4):104–107.
30. Phani Kumar GK, Battu G, KothaNS. Isolation and evaluation of tamarind seed polysaccharide being used as a polymer in pharmaceutical dosage forms. *Res J Pharm BiolChemSci* 2011;2(2):274–290.
31. Mirza MA. Solubility Enhancement of Diclofenac Using Solid Dispersions. *Int J Pharm Pharmacol* 2021;5(1):1–6.
32. Nikolakakis I, Tsarvoulis K, Malamataris S. Water retention and drainage in different brands of microcrystalline cellulose: Effect of measuring conditions. *Eur J Pharm Biopharm* 2006;63(3):278–287.
33. Neil John Alderman. Non-Newtonian Fluids: Introduction and Guide To Classification and Characteristics. *EngSci Data Unit, Data Items* 2016;(January):1–33.





Sagar Muley et al.,

**Table 1: Investigated formulation of tamarind kernel powder**

Dosage forms	Drugs/ Main component
Suspending agent	Nimesulide[4]
Sustain release tablet	Ambroxol hydrochloride [5], Metformin HCl [6], Nevirapine[7], Salicylic acid [8]
Sustain release spheroids	Lornoxicam [9], Diclofenac sodium [10]
Microspheres	5Flourouracil [11]
Tablets	Famotidine [12], Acyclovir sodium [13]
Mucoadhesive tablet	Ciprofloxacin HCl[14], Diclofenac sodium [15]
Mucoadhesive patches	Metronidazole [16]
Solid dispersion	Aceclofenac, Atorvastatin, Irbesartan[17]
In situ gel	Ketorolac tromethamine[18]
Pellets	Lansoprazole[19]
Modified beads	Ibuprofen [20]
Edible films	Geraniol[21]
Floating tablet	Metformin HCl[22], Bupropion [23]
Liquisolid formulation	Paclitaxel [24]
In Emulsion	Canola oil [25], Sesame seed oil [26]
Functional skin and epidermal layer	Formation of functional skin and epidermal layer with all biological sensory functions to study any drug [27]

**Table 2: Micromeritic properties of TKP and CMTKP**

Powder/Properties	TKP	CMTKP
Bulk density (g/ml)	0.3837±0.004	0.5034±0.003
Tapped density (g/ml)	0.4770±0.005	0.6238±0.008
True density (g/ml)	1.3795±0.006	1.3801±0.007
Hausner ratio	1.24±0.004	1.24±0.013
Carr's index (%)	19.57±0.24	19.30±0.86
Angle of repose (degree)	35.86±1.27	44.5±1.01

Values are expressed as mean ± SD (n=3)

**Table 3: pH, swelling index, water retention capacity and surface tension of TKP and CMTKP**

Test	TKP	CMTKP
pH	7.5±0.08	9.5±0.08
Swelling index (%)	112.8±4.8	223.3±2.4
Water retention capacity (%)	32±0.8	65±0.8
Surface tension (dynes/cm)	39.95±1.02	47.27±1.31

Values are expressed as mean ± SD (n=3)

**Table 4: Characteristic peaks observed in X-ray diffraction graph of TKP and CMTKP**

Peak	2-Theta <sup>o</sup>	Net Height (Cps)	Lin (Counts)	Inference
TKP-Peak 1	19.924	41.8	785	It may be a characteristic peak of TKP
CMTKP-Peak 1	20.153	16	298	The intensity of characteristic peak get decreased in CMTKP
CMTKP-Peak 2	31.855	33	593	These both additional peaks might be due to the presence of the carboxymethyl group in CMTKP
CMTKP-Peak 3	45.605	14.4	252	





Sagar Muley et al.,

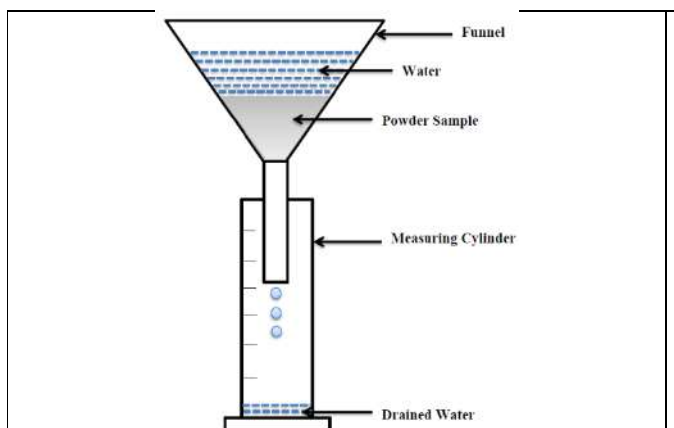


Fig. 1: Experimental set up for finding water retention capacity

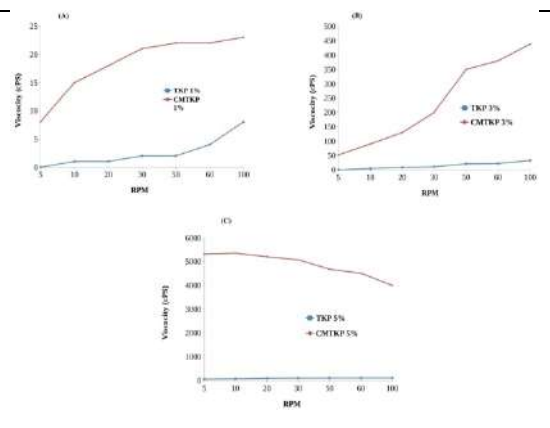


Fig.2: Graphs for Viscosities of TKP and CMTKP dispersions of A) 1%, B) 3% and C) 5%



Fig. 3: Microbial growth studies of A) TKP and B) CMTKP in using nutrient agar

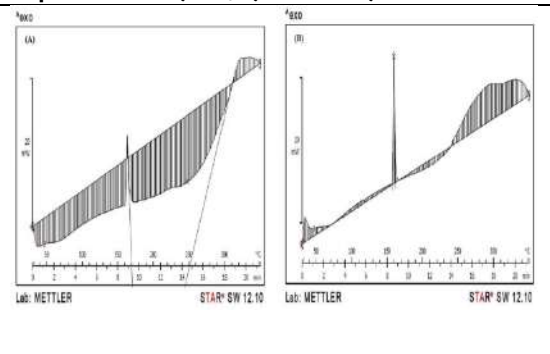


Fig. 4: DSC thermo gram of (A) TKP and (B) CMTKP

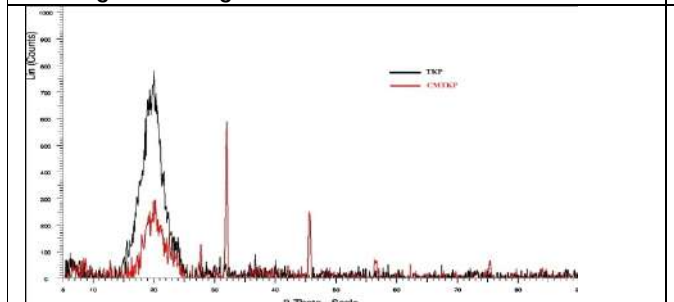


Fig. 5: Overlay XRD graph of TKP and CMTKP

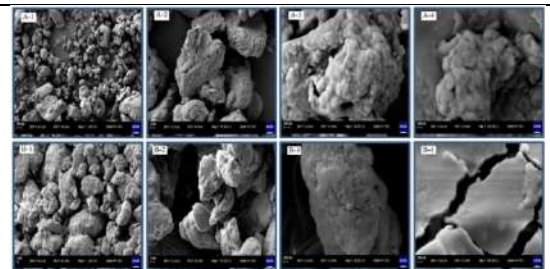


Fig 6: SEM images at different magnifications for TKP; A-1) 2KX, A-2)10KX, A-3) 50KX, A-4) 100KX and for CMTKP; B-1) 2KX, B-2) 10KX, B-3) 50KX, B-4) 100KX





## A Virtual Scenario E-Commerce during Covid-19 Pandemic in India

Ashish Joshi<sup>1</sup>, Nisha Singh<sup>2\*</sup> and Suman Ramapati<sup>2</sup>

<sup>1</sup>Associate Professor, SLS, PDEU, Gandhinagar, Gujarat, India.

<sup>2</sup>Research Fellow, SLS, PDEU, Gandhinagar, Gujarat, India.

Received: 16 Dec 2021

Revised: 28 Dec 2021

Accepted: 12 Jan 2022

### \*Address for Correspondence

**Nisha Singh**

Research Fellow,

SLS, PDEU, Gandhinagar,

Gujarat, India.

Email: nisha.sphd18@sls.pdpu.ac.in



This is an Open Access Journal / article distributed under the terms of the **Creative Commons Attribution License** (CC BY-NC-ND 3.0) which permits unrestricted use, distribution, and reproduction in any medium, provided the original work is properly cited. All rights reserved.

### ABSTRACT

The whole economy of the world has been collapsed due to a deadly Corona virus (COVID-19). The present study investigates the scenario and contribution of E-Commerce during Coronavirus (COVID-19) pandemic in India. COVID-19 crisis accelerated an expansion of E-commerce towards (a) profitability, (b) customers, (c) types of products and (d) new firms' expansion. Some of these changes in the E-commerce landscape across will likely to be the possibility of a new wave. It reflects in the context of immediate service during such time online shopping platform is the best option for consumers. The research based on the secondary data and it has been extracted from the Statista Website and explored the required data in a graphically manner. Based on this the study finds contribution of E-commerce towards revenue growth which grew highest by 38.50% in the year 2020 and is expected to be decreased by 7.70% in 2024 and sales retails will be grown up by \$6388 U.S. dollars. While India's GDP growth was declined by nearly 25% in the first quarter of fiscal year 2021 as compare to the same period in the previous year.

**Keywords:** Scenario of E-commerce, Impact of Coronavirus (COVID-19), Intermediate, Contribution of digital marketing.

## INTRODUCTION

The Indian E-commerce market has been one of the biggest beneficiaries of the pandemic. E-commerce includes buying and selling of products through an electronic medium by consumer, retailer and business. According to the World Health Organization (WHO) report there are several pandemics in this history that has been responsible to change the human life. One of these is COVID-19 pandemic which affected the whole e-commerce of the world; it has not been changed only the nature of business but also the life of human being. Now people less prefer to go brick and mortar shopping, crowded area, following social distancing, buying from home, prefer work from home and





**Ashish Joshi et al.,**

feels to stay at home i.e., Walmart grocery e-commerce. For millions of people online shopping is one of the most convenient platforms for the shoppers for purchasing different types of products and service. These days E-commerce has also replaced the traditional marketing all over the world. Now mass media and social media also playing an important role by providing new and updated features, trying to connect the people via Facebook, made the online study easier by introducing online applications like Zoom, Microsoft Teams etc.

E-commerce transactions can be divided into B2B that is business to business, B2C or business to consumer, C2C or customer to customer. The major problem people face in online delivery system is the high price and customer needs to pay for food and delivery charges for home delivery (Sultana.S., &Islam, A.,2020) which is only the safest acceptable option. Big retailers had their stores turned off temporarily. In addition, due to pandemic declining footfalls, medium-sized and small sized retailers are battling the situation(Khan, A., Liaquat, S., Sheikh, J., Pirzado, A, A.,2021).The more consumers have the fear of Covid-19, the more use of digital channel (online banking, online payment, virtual card, virtual purse, shopping websites) and social media will increase (Ekinci, G., Akyilmaz, B., 2020). A company has temporarily frozen operations or has decided to implement an innovation-driven remote working system, how to approach digital marketing strategy should be a primary focus in these worrying times ahead - if it is not already (Pandya,N., M., 2020).

E- Commerce market upsurge after COVID-19 pandemic. In India E-commerce industries have upward shift during the lockdown period. Online shopping is a new trend for retailers, buyers, and consumers. Pre COVID-19 and post COVID-19 researchers have noticed the maximum revenue generation in India's E-commerce industry after lockdown. Many recent reports represent E-commerce market is mainly driven by a mobile shopping. It has projected to grow 21% annually over in the next few years. Furthermore, E-commerce capability has blended with the digital world and no longer needed traditional and physical retailing. COVID-19 crisis is undoubtedly changing the pattern many industries have included new technologies to accelerate the growth in the business. The pandemic has strengthened the online purchasing power parity in India as well as all over the world. Number of start-ups in the sector of online marketing have been established. Government authorities have also started recommending online shopping for avoiding the crowd.

E-commerce has gained great achievement in the last few years. In the E-commerce field, companies like Alibaba and Amazon played role as a leader. The past year witnessed unique consumer trends in many ways. Amazon also took advantage of offline stores and it was a leverage digital technology to reach customer's doorstep, Grofers were went to online shopping first time through technology to reach out to the customers, Flipkart witnessed new user growth to ensure the customer convenience of customers. It has not affected only the point of retailers, manufacturers but also affected the consumer behavior widely and people are now shifting to shop online instead of visiting physical shop counter and trying less contacts with the others. Year like 2020 and 2021 was a challenging year for everyone. While survey data shows based upon generational differences shopping behavior has lot of variations. It is likely to be concerned about the brick-and-mortar shopping in future. Moreover, product categories shifting from unnecessary product to the necessary one. Mostly, products like health and safety, food and beverages, shelf stable goods, digital streaming were purchased more while the products luxury goods, fashion and apparel were not the significant important to buy during that period. Thus, online shopping is a structural shift for the whole economy in terms of shopping behaviors with a greater number of customers and businesses relying on E-commerce.

#### **Literature Review**

Elrhim, M. A., & Elsayed, A. (2020), conducted their study on effects of the COVID-19 spread on global E-commerce market by selecting five foremost largest e-commerce companies; American Amazon, Chinese Alibaba, Japanese Rakuten, German Zalando, United Kingdom Asos with regards to their revenues and market values. The data has been considered on daily basis from 15<sup>th</sup> March, 2020 to 25<sup>th</sup> May, 2020 in which "new/total corona virus cases" and "new/total corona virus deaths" are used as an independent variables while "returns of the shares" is used as a dependent variable of e-commerce companies to the financial global markets. The study analyzed data and



**Ashish Joshi et al.,**

represented it by using descriptive and diagnostic statistics which is measured the value of mean, median, minimum value, maximum value, standard deviation etc. and multiple regression used to check the effects between two variables. The percentage of the effects of the virus is different from country to country. The study revealed Chinese company Alibaba and Rakuten Japanese Company were more influenced by corona virus new/total cases on share price returns.

Bhatti, A., Akram, H., Basit, H. M., Khan, A. U., Raza, S. M., & Naqvi, M. B. (2020), focused their study on trends of E-commerce during COVID-19 Pandemic and explained that coronavirus is the set of viruses which can be effects with the lower airway and the result comes like pneumonia, bronchitis etc. In this article, researchers tried to examine two things; issues or embarrassing situation of coronaviruses and notable progress in e-commerce which might be change or effect the behavior of consumers in future. Furthermore, researchers able come to know through this article the role of e-commerce during Covid-19 pandemic, how it grew the wealth, how it represented as a substitute source in this situation and meanwhile it impacts on whole e-commerce.

K.Susmitha, (2020), the key purpose of this research is to acknowledge the impact of COVID-19. Pandemic surged the B2C pattern by doing business online. E- Commerce has changed the buying behavior of the consumers of a sudden. In the study researcher have collected secondary data from various websites. Survey shows the women buying behavior prone to take advantage of online shopping more than men. Study also shows the challenges in rural areas without proper mechanism. However, by 2024 E- commerce sales will be projected to grow. SharmaK., (2020), studied E- commerce market in India after COVID-19 pandemic. In this paper researcher studied about the rise in online shopping. The study also reflects the growth of E-commerce by comparing the websites, trends, activities and total outcome in the pandemic. She emphasized on a popularity of online retailing in electronics, fashion and accessories, pharma and fast-moving consumer goods (FMCG). The main purpose of this study is to show the overall growth of the industry.

Bohdana H., (2021), investigates the role of Industry 4.0 in overcoming the Covid-19 pandemic situation in the global economy. The researcher has identified 4.0 companies which manufactures personal protective equipment's in North America and the pros and cons of 4.0 industries by involving technology. Thus, he concludes with the change in production cycle with involving 4.0 technology. Lodni.C., Najmaei. M., Mansori., S, (2021), this study showed E-grocery industry in Germany provided services during the pandemic. Researchers have collected data from various platforms to understand the challenges faced by consumers. Also, paper reflects sentimental analysis for future reference basis upon the consumer views for using e-grocery for a long even after pandemic. The main reflection of this paper is to increase customer satisfaction and to create their loyalty.

Oven, H., Hicintuka, M., (2020), the purpose of this study is to investigate the effects on E-commerce on international level. The aim of this study is understanding the firm's involvement during pandemic. Researcher emphasized on empirical data and focused on digital business environment and international value chain. Furthermore, this research is a quantitative approach which enables the possibility for several industries in such scenarios. This study is most likely to emerge and contributes to current situations that how firms can be affected depending on the country. Kumar, P., Agarwal, N., Saraswat, H., (2021), this study is step towards identifying activities of FMCG products among housewives through electronic medium. Researcher discusses the internet marketing, online transaction processing, electronic data interchange (EDI), inventory management system and automated data collection systems. There are three areas of E -commerce online retailing, e markets and online auctions are being showcased in the paper which has been resulted to E- commerce. The main objective of this paper to know the hike of E- commerce in FMCG industry in post COVID. Demand for household items and grocery items are obtained more through home deliveries. Small and big industries have created lot of opportunities for them by selling essential and non-essential items through online.





**Ashish Joshi et al.,**

## RESEARCH METHODOLOGY

This research addresses the impact of COVID-19 on the global E-commerce industry and its changing patterns. The study has been incorporated on secondary research basis and required data has been collected from *Statista Website*.

- a) The present study is trying to analyze the revenue growth of India in E-commerce industry in which market growth were observed based on consumer buying behavior, different regions, economic factors and companies' involvement.
- b) Also, it examines the importance of E-commerce from this study and their substitute source available in the market.
- c) Financial data considered like the financial reports of the companies, research papers on digital marketing, blogs, articles, government organizations reports are being observed.

### Data Analysis

The study adopted statistical tools which is based on both types of analysis like descriptive and quantitative nature. With the help of descriptive analysis, the present study tried to predict the India's E-commerce revenue growth, retail E-commerce sales worldwide for the year 2018 to year 2024 and also estimated quarterly effect of COVID-19 on India's GDP for the financial year 2020 and 2021. The above figure 1 predicts the revenue growth in the field of E-commerce industry in India from the year 2018 to year 2024. The necessary data has been extracted from the *Statista* website which is published by Statista Research Department on April 29, 2021. From the figure we can observe that the E-Commerce market in India grew by 38.50% in the year 2020 and the Statista Digital Market Outlook also trying to predict that the revenue growth of India will slowly decline in the coming year (2024) expected to be just 7.70%.

The above vertical bar 2 represents the retail E-Commerce sales worldwide from the year 2018-2024. The required data has been taken from the *Statista* website. From the figure we can observe that the retail sales are continuously increasing year by year. It can be predicting that the retail sales will be grown up by \$2,982 to \$6,388 by the year 2024. The above figure 3 analyses the estimated quarterly impact of the COVID-19 on India's GDP growth of the year 2020 and 2021. From the table it can be observe that the India's quarterly GDP was estimated to grow by 0.4% in the Q3 financial year 2021 as compared to the previous quarter (Q3) financial year 2020 by 3.3%. We can clearly see that the significant improvement period from April, 2020 and June, 2020 when country went into lockdown to contain the virus and on the other side we can see that the GDP growth of India was declined by nearly 25% in the first quarter of fiscal year 2021 as compare to the same period in the previous year.

## CONCLUSION

The present study conducted with a view to know the scenario or impact of Coronavirus (COVID-19) using the virtual platforms through E-Commerce Industry. Based on quantitative nature, the study tried to exhibit the retail sales worldwide, predicted revenue growth of India for the year 2018-2024 as well as effects of the COVID-19 on India's GDP. The findings of the study contribute towards revenue growth which grew highest by 38.50% in the year 2020 and is expected to be decreased by 7.70% in 2024 and sales retails will be grown up by \$6388 U.S. dollars. While India's GDP growth was declined by nearly 25% in the first quarter of fiscal year 2021 as compare to the same period in the previous year. Lastly, the study represents the present and future scenario of COVID-19 effects on the E-Commerce in India and all over the world.

## REFERENCES

1. Elrhim, M. A., & Elsayed, A. (2020). The Effect of COVID-19 spread on the e-commerce market: The case of the 5 largest e-commerce companies in the world. Available at SSRN 3621166.





**Ashish Joshi et al.,**

2. Bhatti, A., Akram, H., Basit, H. M., Khan, A. U., Raza, S. M., & Naqvi, M. B. (2020). E-commerce trends during COVID-19 Pandemic. *International Journal of Future Generation Communication and Networking*, 13(2), 1449-1452.
3. K.Susmitha., (2020). Impacts of COVID 19 on E-Commerce. *Journal of Interdisciplinary cycle research*, ISSN: 0022-1945, Volume XII, Issue IX.
4. Sharma.K., (2020). A surge in E-commerce market in India after COVID-19 pandemic, ISSN: 2581-5830, Volume III, Issue IV.
5. Bohdana.H., (2021). The impact of the COVID-19 pandemic on industry 4.0 in the context of global economic development.
6. Lodni.C., Najmaei. M., Mansori. S., (2021), The effect of COVID-19 pandemic on the German E-grocery industry with respect to challenges for retailers and customer satisfaction. Volume 3, Issue 3 (1-31)
7. Oven, H., Hicintuka, M., (2020), COVID-19: How does it affects International E-commerce firms? *Linnaeus university*
8. Kumar, P., Agarwal, N., Saraswat, H., (2021), E-Commerce: A Catalyst of Marketing Especially On Fmcg Product Under Covid Pandemic, 8(2) 1-11
9. Respatiningsih, H., (2020), The Impact of E-Commerce on the Marketing Performance of MSMEs During the Covid19 Pandemic Mediated by Competitive Advantage, Volume 169
10. Pollak, F., Malinak, B., Markovic, P., Vilagi, R., (2021), Innovations in the Management of E-Commerce Entities Operating on the Slovak Market – Analysis of Customer Interactions during the COVID-19 Pandemic
11. Song, S., (2021), Analysis on China Cross-Border E-Commerce Under COVID-19, Volume 166
12. Qin, X., Liu, Z., Tian, L., (2021), The optimal combination between selling mode and logistics service strategy in an e-commerce market, 639-651
13. Sultana, S., Islam, A., (2020), Role of e-commerce for the survival of food service industry during covid-19
14. Khan, A., Liaquat, S., Sheikh, J., Pirzado, A. A., (2021) The Impact of Corona Virus (Covid-19) on E-Business in Pakistan, Volume 27, ISSN 2204- 1990, 1323-6903
15. Ekinci, G., Akyilmaz, B., (2020), The Relation Between the Fear of Covid-19 Pandemic, The Use of Digital Channel and The Use of social media, ISSN- 2602-4179
16. Pandya, N, M., (2020), Digital Transformation after COVID19: The Next Normal, ISSN 0007-473X
17. Radhakrishnana, V., (2021), E-Commerce industry and its effect on the world today, Volume 03 Issue 02, ISSN 2582-4376
18. Rayka, D., (2020), A Study on E- commerce After COVID-19, Volume 8, Issue 12, ISSN 2321-2853
19. Kumar, A., Dutt, V., (2020), Coronavirus Impact on Marketing, Ecommerce & Advertising: A Deep Study, Volume 7, Issue 15, ISSN 2394-5125
20. Rahman, Ab, H., (2020), Cashless Transactions Through Ecommerce Platform in the Post-Covid-19, Volume 6, Issue 1, ISSN 2462-1293
21. Anand, J, Mr., Mariappan, K., (2021), A Study on Consumers Satisfaction Towards Online Marketing on Durable Goods inKovilpatti Taluk, Thoothukudi District, Volume 1
22. Sivakumar, M., Anupriya., (2021), E-Commerce Trends During Covid -19 Pandemic, Volume1
23. Alfonso, V., Boar, C., Frost, J., Gambacorta, L., E-commerce in the pandemic and beyond: online appendix
24. The impact of COVID-19 on E-commerce., (2021) <https://ecommercenews.eu/the-impact-of-covid-19-on-e-commerce/>
25. Lockdown proved inflection point for e-commerce in India., (2021) <https://www.thehindubusinessline.com/news/national/lockdown-proved-inflection-point-for-e-commerce-in-india/article34148745.ece>
26. Meyer.S., (2021) Understanding the COVID-19 effect on online shopping behavior<https://www.bigcommerce.com/blog/covid-19-e-commerce/#product-categories-shifting-during-covid-19>.
27. E-commerce in the time of COVID-19., (2020) <https://www.oecd.org/coronavirus/policy-responses/e-commerce-in-the-time-of-covid-19-3a2b78e8/>





**Ashish Joshi et al.,**

**Table 1. Tabular views of the literature reviewed.**

Sr. No.	Researchers	Company/firm/country	Duration	Impact/relationship
1	Elrhim, M. A., & Elsayed, A	American Amazon, Chinese Alibaba, Japanese Rakuten, German Zalando, United Kingdom Asos	2020	Share price return
2	Bhatti, A., Akram, H., Basit, H. M., Khan, A. U., Raza, S. M., & Naqvi, M. B	Amazon.com, Ebay.com, Rakuten.co.jp, Samsung.com, Walmart.com, Appel.com, Aliexpress.com, Etsy.com, Homedepot.com, Allegro.pl	2020	Wealth
3	K. Susmitha	Amazon	2020	Men and women
4	Sharma, K	Amazon, Flipkart, India mart, Myntra, Snapdeal, Firstcry, 1 mg, Book my show, Nykaa,2gud	2020	Industrial growth
5	Bohdana.H.	4.0 Industries	2021	4.0 companies
6	Lodni.C., Najmaei. M., Mansori., S	Omnichannel, Germany	2021	Consumers
7	Oven, H., Hicintuka, M	Sweden	2020	Firms
8	Kumar, P., Agarwal, N., Saraswat, H	FMCG	2021	Household items

**Table 2. Prediction of E-Commerce revenue growth in India from 2018 to 2024**

Year	Revenue Growth
2018	37.40%
2019	32.60%
2020	38.50%
2021	19.80%
2022	14.60%
2023	10.70%
2024	7.70%

Source: Statista

**Table 3. Retail E-Commerce sales worldwide from 2018 to 2024.**

Year	Sales (in billion U.S. dollars)
2018	2982
2019	3354
2020	4280
2021	4891
2022	5424
2023	5908
2024	6388

Source: Statista



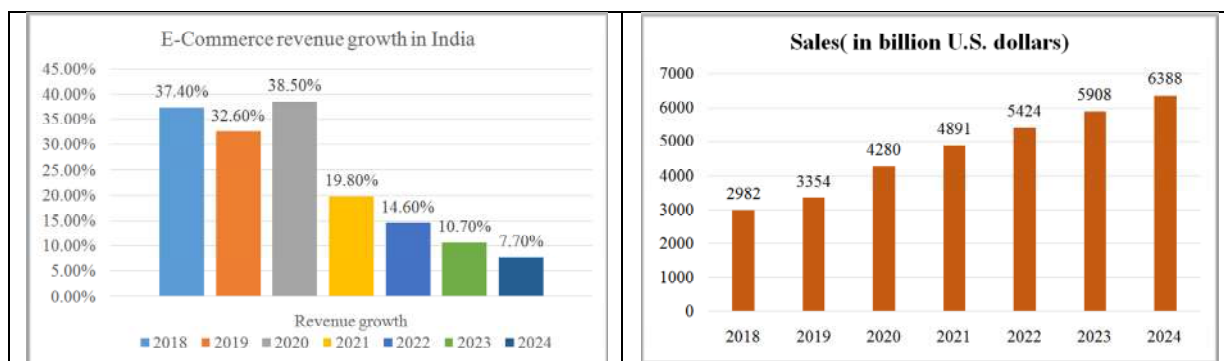


**Ashish Joshi et al.,**

**Table 4. Estimated quarterly impact from the coronavirus (COVID-19) on India’s GDP growth in financial year 2020 and 2021.**

Period/Characteristic	Quarter Change
Q3 FY 2021	0.4%
Q2 FY 2021	-7.4%
Q1 FY 2021	-24.4%
Q4 FY 2020	3%
Q3 FY 2020	3.3%

Source: Statista



Source: Researchers’ Computation.

Source: Researchers’ Computation.

**Fig.1.E-Commerce revenue growth in India**

**Fig.2.Sales( in billion U.S. dollars)**



Source: Researchers’ Computation.

**Fig.3..Quarter Change**





## HPTLC Fingerprinting of Secondary Metabolites in the Aqueous Extracts of Stem Bark and Leaves of *Ziziphus rugosa* L.

Midhila Baby<sup>1\*</sup> and Mathews.T.Thelly<sup>2</sup>

<sup>1</sup>Assistant Professor, Department of Botany, Kuriakose Elias College, Mannanam, Kottayam, Kerala - 686561, India.

<sup>2</sup>Associate Professor and HOD, Department of Botany, K.E. College, Mannanam, Kottayam, Kerala - 686561, India.

Received: 14 Nov 2021

Revised: 21 Dec 2021

Accepted: 11 Jan 2022

### \*Address for Correspondence

#### Midhila Baby

Assistant Professor,  
Department of Botany,  
Kuriakose Elias College,  
Mannanam, Kottayam,  
Kerala - 686561, India.

Email: midhilababy5@gmail.com



This is an Open Access Journal / article distributed under the terms of the **Creative Commons Attribution License** (CC BY-NC-ND 3.0) which permits unrestricted use, distribution, and reproduction in any medium, provided the original work is properly cited. All rights reserved.

### ABSTRACT

Many of the current medications that are in use today for various ailments are based on plants and plant-based products. HPTLC (High-Performance Thin Layer Chromatography) is a useful technique for determining the analytical quality of herbal items and various novel products from natural sources. This study aims to develop HPTLC fingerprint profiles for various secondary metabolites in the aqueous extracts of the stem bark and leaves of the medicinal plant *Ziziphus rugosa* L. To obtain maximum resolution for chromatographic fingerprinting, analysis for each compound is done utilizing mobile phase and derivatization reagent particular to that metabolite. The present study is carried out using a CAMAG HPTLC system equipped with Linomat V applicator, TLC scanner 4, TLC visualizer 2 and Reprostar 3 with 12bit CCD camera for photo documentation, controlled by winCATS- 4 software. The fingerprinting of aqueous extract of the plant revealed 8 alkaloids (stem bark-4, leaf-4), 9 steroids (stem bark-3, leaf-6), 8 flavonoids (stem bark-2, leaf-6), 2 glycosides (leaf-2), 5 saponins (stem bark-2, leaf-3), 3 tannins (stem bark-1, leaf-2), and 10 terpenoids (stem bark-1, leaf-9).

**Keywords:** Aqueous extract, *Ziziphus rugosa* L., HPTLC profile, Alkaloids, Steroids, Flavonoids, Glycosides, Saponins, Tannins, Terpenoids.



**Midhila Baby and Mathews.T.Thelly**

## INTRODUCTION

A wide variety of chemical compounds are synthesized by the plants, which are classified based on chemical class, biosynthetic origin, and functional groups [1]. Natural compounds derived from plants are well-known in the pharmaceutical industry for their structural diversity and pharmacological activity [2,3]. Plants have a diverse spectrum of primary and secondary metabolites like amino acids, proteins, carbohydrates, alkaloids, flavonoids, glycosides, tannins, steroids, terpenoids, saponins, etc. It is a challenging task to isolate, identify and characterize these compounds, as well as to establish pharmacological and therapeutic efficacy. In addition to therapeutic potential, secondary metabolites are important for the manufacture of dyes, colouring and flavouring agents, natural pesticides and herbicides, fragrances, and cosmetics. Chromatographic fingerprints obtained through TLC and HPTLC techniques are useful for quality checking, authentication, and identification of medicinal plants [4]. HPTLC Chromatographic fingerprints facilitate the determination of major bioactive constituents in medicinal plants. Through scanning densitometry, qualitative and quantitative measurements could be done, and the separation of individual secondary metabolites and resolution is better than TLC.

*Ziziphus rugosa* L. belongs to the family Rhamnaceae and is a wild, huge straggling scandent shrub with elliptic, generally subcordate alternate leaves, paniculate flowers, and a thorny stem. The fruit is a tiny drupe and the wood is crimson and somewhat hard. When fully ripe, the fruit is glabrous and white. The plant grows in the Western Ghats' deciduous and semi- evergreen forests. This plant is traditionally used for the treatment of Diarrhoea, Menorrhagia, Ulcer, Skin disease, Cough and Hypotension [5,6,]. The compounds isolated from the plant include Lupeol, Betulin, Betulinic Aldehyde, Betulinic acid, Alphitolic acid, Euscaphic acid, Zizyberenic acid,  $\beta$ -sitosterol, Nummularine-P, Sativanine-H, Rugosanine-B etc. The pharmacological studies revealed that *Z. rugosa* L. possess, antioxidant, antidiabetic, anti- inflammatory, analgesic, anti-cancer, CNS depressant, antimicrobial, antiparasitic, and dermatological effects. [7]. The present study is intended to reveal the total alkaloids, flavonoids, steroids, glycosides, terpenoids, tannins and saponin profile in the aqueous extract of stem barks and leaves of *Z. rugosa* L. HPTLC chromatographic fingerprints will serve as a platform for the authentication and bioefficacy studies on *Z. rugosa* L.

## MATERIALS AND METHODS

### Collection of plant material

The leaves and stem bark of *Ziziphus rugosa* L. were collected from various localities in Idukki, Kerala. The plant was identified and kept at the Department of Botany, K.E College, Mannanam.

### Preparation of plant extract

The leaves and stem bark of the plant were washed gently in tap water and then in distilled water. It was shredded down into small pieces under hygienic conditions. The parts were dried under shade and were grinded to obtain a fine powder. The powdered samples were extracted with distilled water for 24 h using the Soxhlet apparatus. The extracts were concentrated in a vacuum using a rotary evaporator.

### HPTLC analysis

HPTLC analysis was carried out using the standard methods [8]. 100 mg extract was dissolved in 5ml HPTLC grade methanol, solution centrifuged and used for HPTLC analysis. For the present study, CAMAG HPTLC system equipped with Linomat V applicator, TLC scanner 4, TLC visualiser 2, and Reprostar 3 with 12bit CCD camera for photo documentation, controlled by win CATS- 4 software was used. Each sample (Stem bark and leaf) was loaded in triplicates. The 8 $\mu$ l samples were spotted in the form of bands of width 8 mm with microlitre syringe on a pre-coated silica gel plate 60 F-254. Respective mobile phase and derivatization reagent for each secondary metabolite was used. For alkaloids ethyl acetate-methanol-water (100:13.5:10) and Dragendroff's reagent were used as the mobile phase and spraying reagent respectively. The mobile phase, ethyl acetate-formic acid-glacial acetic acid-water (100:11:11:26) and natural product reagent was used for the separations of flavonoids. Chloroform – acetone (8:2) and



**Midhila Baby and Mathews.T.Thelly**

anisaldehyde sulphuric acid were used as the mobile phase and spraying reagent for steroids. Glycosides were separated using the mobile phase, ethyl acetate-methanol-water (20:2.8:2) and derivatised by Chloramine T reagent. The mobile phase used for saponins was chloroform-glacial acetic acid-methanol-water (6.4:3.2:1.2:0.8) and anisaldehyde sulphuric acid as the spraying reagent. For tannins, toluene-ethyl acetate-formic acid-methanol (3:30.8:0.2) and ferric chloride reagent was used. n-hexane-ethyl acetate (7.2:2.8) served as the mobile phase for terpenoid studies and was derivatised using anisaldehyde sulphuric acid reagent. The developed plate was dried by hot air to evaporate solvents from the plate. The plate was kept in photo documentation chamber and the images were captured under visible light, UV 254 nm, and UV 366 nm. After derivatization, the plates were photo-documented in visible light and UV 366 nm mode. Before derivatization and after derivatization, the plates were fixed in the scanner stage and scanned at UV 254 nm and UV 366 nm.

**RESULTS AND DISCUSSION**

The current study aims to improve the HPTLC fingerprint profiles of secondary metabolites in *Z. rugosa* L. aqueous leaf and stem bark extracts. The HPTLC separation of major secondary metabolites produced high resolution and reproducible peaks in *Z. rugosa* L. stem bark and leaf. It revealed the presence of secondary metabolites such as alkaloids, flavonoids, glycosides, saponins, tannins, steroids, and terpenoids.

**Alkaloids**

The aqueous extract revealed seven spots (Rf value between 0.018 and 0.987) in stem bark and seven spots in leaf (Rf value between 0.429 and 0.981). The compound with an Rf value of 0.684 is common to stem bark and leaf. The alkaloid bands could be distinguished by yellow, orange-yellow color in visible light and blue, violet, blue-green or yellow fluorescence under UV 366nm. On spraying Dragendorff's reagent, alkaloids appeared brown and orange-brown. In the stem bark, peaks 4 (Rf 0.805), 5 (Rf 0.856), 6 (0.966), 7 (0.987) and in leaf, peaks 4 (Rf 0.816), 5 (Rf 0.844), 6 (Rf 0.881), and 7 (Rf 0.981) were identified as alkaloids (Table 1, Figure 1). Alkaloids have been shown to have anti-inflammatory, anticancer, analgesic, local anesthetic, and pain-relieving properties, as well as neuropharmacological, antibacterial, and antifungal properties. Alkaloids are important in medicine and various aspects of human life as diet elements, supplements, and medications. Alkaloids are also significant substances in organic synthesis for the development of novel semisynthetic and synthetic chemicals with potentially higher biological activity than their parent molecules [9].

**Steroids**

The aqueous extract showed the presence of five bands from stem bark (Rf value between 0.490 and 0.982) and ten from leaf (Rf value between 0.035 and 0.992). Blue- violet coloured zones were present in the chromatogram at visible light mode and UV 366 after derivatization with anisaldehyde sulphuric acid confirmed the presence of steroids in the aqueous leaf and stem bark extract of the plant. The Rf values 0.490, 0.674 and 0.863 for the spots of aqueous stem bark extract and Rf values 0.334, 0.774, 0.863, 0.892, 0.911, 0.992 for the spots of aqueous leaf extract were detected as steroids. Steroid compound with Rf value 0.863 is of common occurrence in stem bark and leaf (Table 2, Figure 2). Plant steroids are categorized into many classes based on their chemical structure, pharmacological activity, and source of isolation. Anti-tumour, immunosuppressive, hepatoprotective, antibacterial, plant growth hormone regulator, sex hormone, anthelmintic, cytotoxic, and cardiotoxic actions are some of the medical, pharmaceutical, and agrochemical properties of plant steroids [10].

**Flavonoids**

The Stem bark extract exerted three prominent bands (Rf value between 0.532 and 0.918) and seven bands (Rf value between 0.021 and 0.960) in leaf extract of the plant. Flavonoids show dark yellow, blue or green fluorescence at UV 366 nm. On spraying natural product reagent, the flavonoids appeared in orange- yellow and yellow green colouration. The Rf values 0.532 and 0.808 for the spots of aqueous stem bark extract and Rf values 0.021, 0.082, 0.153, 0.190, 0.379, and 0.642 for the spots of aqueous leaf extract of the plant were detected as flavonoids (Table 3, Figure



**Midhila Baby and Mathews.T.Thelly**

3). Flavonoids have a wide range of biological actions, including antioxidant, anti-inflammatory, anticancer, cardioprotective, hepatoprotective, antibacterial, antiviral, antiallergic, vasodilatory, and neurological disease treatment. They possess inhibitory effect on enzymes like Kinase,  $\alpha$ -glucosidase, Hydrolases, hyaluronidase, lipase, alkaline phosphatase, and cAMP phosphodiesterase [11].

**Glycosides**

A total of seven spots were documented from the aqueous extract of the plant. Two spots (Rf value 0.239 and 0.950) were screened from the stem bark and five (Rf value between 0.021 and 0.924) from the leaves. Depending on the type, glycosides show blue, blue green, dark brown, yellow brown, or orange fluorescence at UV 366 after derivatization with Chloramine 'T' reagent. In the leaf extract spots with Rf values 0.021, 0.063, 0.615, 0.924 were found to be glycosidic compounds (Table 4, Figure 4). Many of the medicinally important metabolites are stored in the plants in the form of inactive glycosides. These pharmaceutically valuable glycosides have potential as cardiac drugs, laxatives, analgesics, anti-inflammatory, anti-tuberculosis, expectorant and antispasmodic action.

**Saponins**

Saponin profile and chromatogram of aqueous extract of *Z. rugosa* revealed four spots from stem bark (Rf value between 0.161 and 0.916) and seven spots (Rf value between 0.152 and 0.910) from leaves of the plant. On derivatizing the plates with anisaldehyde sulphuric acid reagent saponins mainly formed yellow brown zones and inspection under UV 366 nm light resulted in blue, violet and brown fluorescent zones. In the stem bark the spots with Rf values 0.340, 0.561 and in leaf spots with Rf values 0.242, 0.350 and 0.568 were identified as saponins (Table 5, Figure 5). Saponins have antimicrobial, anti-tumour, anti-insect, hepatoprotective, haemolytic, and anti-inflammatory properties. They lower blood cholesterol levels and be used as a vaccination adjuvant. Saponins are also commercially important to make soap, detergents, fire extinguishers, shampoos, beer, and cosmetics [12].

**Tannins**

HPTLC Tannin profile showed the presence of 1 band with Rf value 0.0956 from the stem bark and 2 bands with Rf value 0.837 and 0.910 from the leaf of the plant. On derivatization with ferric chloride reagent, tannins appear as bluish- and brown-coloured zones. All the three spots detected were identified as tannins (Table 6, Figure 6). Tannins have been shown to prevent lipid peroxidation in vitro and to scavenge free radicals that are present in prooxidant states in cells. The majority of tannins' actions, including their ability to scavenge free radicals, are largely determined by their structure and degree of polymerization. Additionally, tannins possess properties like antimicrobial, antiviral, cardioprotective, anti-ulcer, anti-diabetic and anti-inflammatory functions [13].

**Terpenoids**

The chromatographic fingerprinting for terpenoids was well resolved at UV 366 nm after derivatization. The plates were sprayed with anisaldehyde sulphuric acid reagent followed by heating and then visualized in day light which showed 3 (Rf value between 0.750 and 0.958) and 15 (Rf value between 0.019 and 0.966) prominent peaks in aqueous stem bark and leaf extracts, respectively. On treatment with anisaldehyde sulphuric acid reagent terpenoid compounds appear as blue, bluish violet or pink spots. In the stem bark spot with Rf value 0.750 and in leaf Rf values 0.019, 0.092, 0.139, 0.219, 0.245, 0.290, 0.853, 0.902 and 0.944 were identified as terpenoids (Table 7, Figure 7). Terpenoids are secondary metabolites with carbon backbones made up of isoprene units, and they are one of the most diverse groups of natural products, accounting for about 55,000 different chemicals in both primary and secondary metabolism [14]. These natural compounds have enormous commercial worth as medications, flavours and fragrances, commodity chemicals, in addition to their wide spectrum of biological capabilities. They have antibacterial, anti-inflammatory, gastroprotective, and hepatoprotective effects [15,16].







## CONCLUSION

The observed HPTLC profiles of various secondary metabolites in the aqueous extract could be employed as a pharmacognostical marker for the authentication of the plant. The presence of different compounds with pharmacological properties justifies the ethnomedicinal usage of the plant for various ailments. Further studies must be carried out for the quantitative estimation and qualitative separation of pharmacologically active chemical compounds.

## ACKNOWLEDGEMENT

The authors acknowledge Central Laboratory for Instrumentation and Facilitation (CLIF), University of Kerala, Kariavattom Campus, Trivandrum for providing HPTLC instrumentation facilities and Mar Thoma College, Tiruvalla, the Research centre.

## CONFLICT OF INTEREST

The authors declare that they have no conflict of interest.

## REFERENCES

1. H. O. Edeoga, D. E. Okwu, and B. O. Mbaebie, "Phytochemical constituents of some Nigerian medicinal plants," *African Journal of Biotechnology*, vol. 4, no. 7, pp. 685–688, 2005, [Online]. Available: <http://www.academicjournals.org/AJB>
2. D. J. Newman and G. M. Cragg, "Natural products as sources of new drugs over the last 25 years," *Journal of Natural Products*, vol. 70, no. 3, pp. 461–477, Mar. 2007. doi: 10.1021/np068054v.
3. E. Schwarz, J. Metzler, J. P. Diedrich, J. Freudenstein, C. Bode, and J. Christian Bode, "Oral Administration of Freshly Expressed Juice of Echinacea Purpurea Herbs Fail to Stimulate the Nonspecific Immune Response in Healthy Young Men: Results of a Double-Blind, Placebo-Controlled Crossover Study," *Journal of immunotherapy*, vol. 4, no.5, pp. 413-420, 2002, doi: 10.1097/01.CJI.0000028168.27659.A7
4. N. A. Farooqui, A. Dey, G. N. Singh, T. S. Easwari, and M. K. Pandey, "Analytical Techniques in Quality Evaluation Of Herbal Drugs," *Asian Journal of Pharmaceutical Research*, vol. 4, no. 3, pp. 112–117, 2014. [Online]. Available: [www.ajprjournal.com](http://www.ajprjournal.com)
5. H. Ara, A. Hassan, and M. Khanam, "Taxonomic study of the genus ziziphus mill. (rhamnaceae) of Bangladesh, Bangladesh," *Journal of Plant Taxonomy*, vol. 15, no. 1, pp. 47-61, 2008
6. Gamble JS: Flora of the presidency of Madras, 1, 2014, 219- 221.
7. M. Eranna, M. Vedigounder, G. K. M, R. Nandeesh, and M. N. Palaksha, "Review on A Wild Medicinal Plant: *Ziziphus rugosa*", *Int. J. Pharm. Sci. Rev. Res*, vol. 62(2), no. 08, pp: 40-44, 2020.
8. H. Wagner, S. Baldt, and E. M. Zgainski, *Plant Drug Analysis*, Springer, Berlin, Germany, 1996.
9. J. Kurek, "Introductory Chapter: Alkaloids - Their Importance in Nature and for Human Life," in *Alkaloids - Their Importance in Nature and Human Life*, IntechOpen, 2019. doi: 10.5772/intechopen.85400.
10. S. S. Patel, and J. K. Savjani, "Systematic review of plant steroids as potential anti-inflammatory agents: Current status and future perspectives," *The Journal of Phytopharmacology*, vol. 4(2), pp: 121-125, 2015.
11. K. S. Sridevi Sangeetha, S. Umamaheswari, C. Uma, M. Reddy, and S. N. Kalkura, "Flavonoids: Therapeutic Potential of Natural Pharmacological Agents," *International Journal of Pharmaceutical Sciences and Research*, vol. 7, no. 10, p. 3924-30, 2016, doi: 10.13040/IJPSR.0975-8232.7(10).
12. A. De and P. Barbosa, " An Overview On The Biological And Pharmacological Activities Of Saponins," *Int J Pharm Pharm Sci*, Vol 6, Issue 8, pp: 47-50, 2014.
13. E. Sieniawska, " Activities of Tannins – From In Vitro Studies to Clinical Trials," *Natural product communications*, Vol. 10, no. 11, pp:1877 – 1884, 2015.





**Midhila Baby and Mathews.T.Thelly**

14. J. R. Hanson, Terpenoids and Steroids: A Review of Chemical Literature: Vol. 7, Specialist Periodical Reports, CRC Press, New York, NY, USA, 1977.
15. A. Sharma, S. C. Sati, O. P. Sati, M.D. Sati, S.K. Kothiyal, D.K. Semwal, and A. Mehta, "A new triterpenoid saponin and antimicrobial activity of ethanolic extract from *Sapindus mukorossi* Gaertn.," *Journal of Chemistry*, 2013. <https://doi.org/10.1155/2013/218510>
16. S.-Y. Cheng, C.-M. Wang, H.-L. Cheng et al., "Biological activity of oleanane triterpene derivatives obtained by chemical derivatization," *Molecules*, vol. 18, no. 10, pp. 13003–13019, 2013. doi: 10.3390/molecules181013003.

**Table 1: HPTLC alkaloid profile of aqueous extracts of *Ziziphus rugosa* L. stem bark and leaf**

Part of <i>Z.rugosa</i>	Peak	Rf	Height	Area	Percentage area	Compound
Stem Bark	1	0.018	0.0137	0.00016	1.85	Unknown
	2	0.134	0.0127	0.00022	2.44	Unknown
	3	0.684	0.1441	0.00360	40.45	Unknown
	4	0.805	0.1425	0.00273	30.75	Alkaloid 1
	5	0.856	0.0763	0.00157	17.60	Alkaloid 2
	6	0.966	0.0173	0.00020	2.28	Alkaloid 3
	7	0.987	0.0331	0.00041	4.62	Alkaloid 4
leaf	1	0.429	0.0658	0.00560	31.12	Unknown
	2	0.684	0.0769	0.00204	11.32	Unknown
	3	0.744	0.0589	0.00263	14.61	Unknown
	4	0.816	0.0691	0.00296	16.46	Alkaloid 1
	5	0.844	0.1671	0.00218	12.12	Alkaloid 2
	6	0.881	0.0961	0.00218	2.11	Alkaloid 3
	7	0.981	0.0267	0.00041	2.25	Alkaloid 4

**Table 2: HPTLC Steroid profile of aqueous extracts of *Ziziphus rugosa* L. stem bark and Leaf**

Part of <i>Z.rugosa</i>	Peak	Rf	Height	Area	Percentage area	Compound
Stem Bark	1	0.490	0.2985	0.01028	8.03	Steroid 1
	2	0.674	0.4018	0.07175	56.01	Steroid 2
	3	0.863	0.3242	0.01322	10.32	Steroid 3
	4	0.906	0.4103	0.02551	19.91	Unknown
	5	0.982	0.2991	0.00734	5.73	Unknown
Leaf	1	0.035	0.2051	0.00776	3.88	Unknown
	2	0.076	0.2673	0.01246	6.22	Unknown
	3	0.334	0.2915	0.02677	13.36	Steroid 1
	4	0.613	0.3898	0.03686	18.40	Unknown
	5	0.687	0.4212	0.03984	19.89	Unknown
	6	0.774	0.3835	0.01735	8.66	Steroid 2
	7	0.863	0.4017	0.01995	9.96	Steroid 3
	8	0.892	0.5976	0.01603	8.00	Steroid 4
	9	0.911	0.4663	0.01598	7.97	Steroid 5
	10	0.992	0.2784	0.00732	3.66	Steroid 6





## Midhila Baby and Mathews.T.Thelly

Table 3: HPTLC Flavonoid profile of aqueous extracts of *Ziziphus rugosa* L. stem bark and leaf

Part of <i>Z.rugosa</i>	Peak	Rf	Height	Area	Percentage area	Compound
Stem Bark	1	0.532	0.0699	0.00403	25.07	Flavonoid 1
	2	0.808	0.0807	0.00349	21.74	Flavonoid 2
	3	0.918	0.1604	0.00855	53.19	Unknown
Leaf	1	0.021	0.0399	0.00053	0.88	Flavonoid 1
	2	0.082	0.0256	0.00063	1.04	Flavonoid 2
	3	0.153	0.1645	0.00596	9.91	Flavonoid 3
	4	0.190	0.3735	0.01150	19.12	Flavonoid 4
	5	0.379	0.0866	0.00623	10.36	Flavonoid 5
	6	0.610	0.0575	0.00299	4.98	Unknown
	7	0.642	0.0402	0.00048	0.79	Flavonoid 6
	8	0.960	0.7980	0.03182	52.92	Unknown

Table 4: HPTLC Glycoside profile of aqueous extracts of *Ziziphus rugosa* L. stem bark and Leaf

Part of <i>Z.rugosa</i>	Peak	Rf	Height	Area	Percentage area	Compound
Stem Bark	1	0.239	0.0488	0.00034	13.96	Unknown
	2	0.950	0.0558	0.00208	86.04	Unknown
Leaf	1	0.021	0.0123	0.00016	0.99	Glycoside 1
	2	0.063	0.0477	0.00104	6.64	Glycoside 2
	3	0.144	0.0240	0.00064	4.10	Unknown
	4	0.615	0.0571	0.00242	15.47	Glycoside 3
	5	0.924	0.1971	0.01138	72.80	Glycoside 4

Table 5: HPTLC Saponin profile of aqueous extracts of *Ziziphus rugosa* L. stem bark and leaf

Part of <i>Z.rugosa</i>	Peak	Rf	Height	Area	Percentage area	Compound
Stem Bark	1	0.161	0.0326	0.00097	6.59	Unknown
	2	0.340	0.0144	0.00049	3.34	Saponin 1
	3	0.561	0.0980	0.00760	51.75	Saponin 2
	4	0.916	0.3804	0.00563	38.32	Unknown
Leaf	1	0.152	0.0652	0.00301	5.72	Unknown
	2	0.242	0.0173	0.00073	1.39	Saponin 1
	3	0.350	0.0417	0.00161	3.05	Saponin 2
	4	0.568	0.2814	0.02566	48.80	Saponin 3
	5	0.708	0.0953	0.00527	10.02	Unknown
	6	0.777	0.0835	0.00609	11.57	Unknown
	7	0.910	0.5410	0.01023	19.45	Unknown

Table 6: HPTLC Tannin profile of aqueous extracts of *Ziziphus rugosa* L. stem bark and leaf

Part of <i>Z.rugosa</i>	Peak	Rf	Height	Area	Percentage area	Compound
Stem Bark	1	0.956	0.0159	0.00045	100	Tannin 1
Leaf	1	0.837	0.0428	0.00165	63.91	Tannin 1
	2	0.910	0.0601	0.0286	36.09	Tannin 2

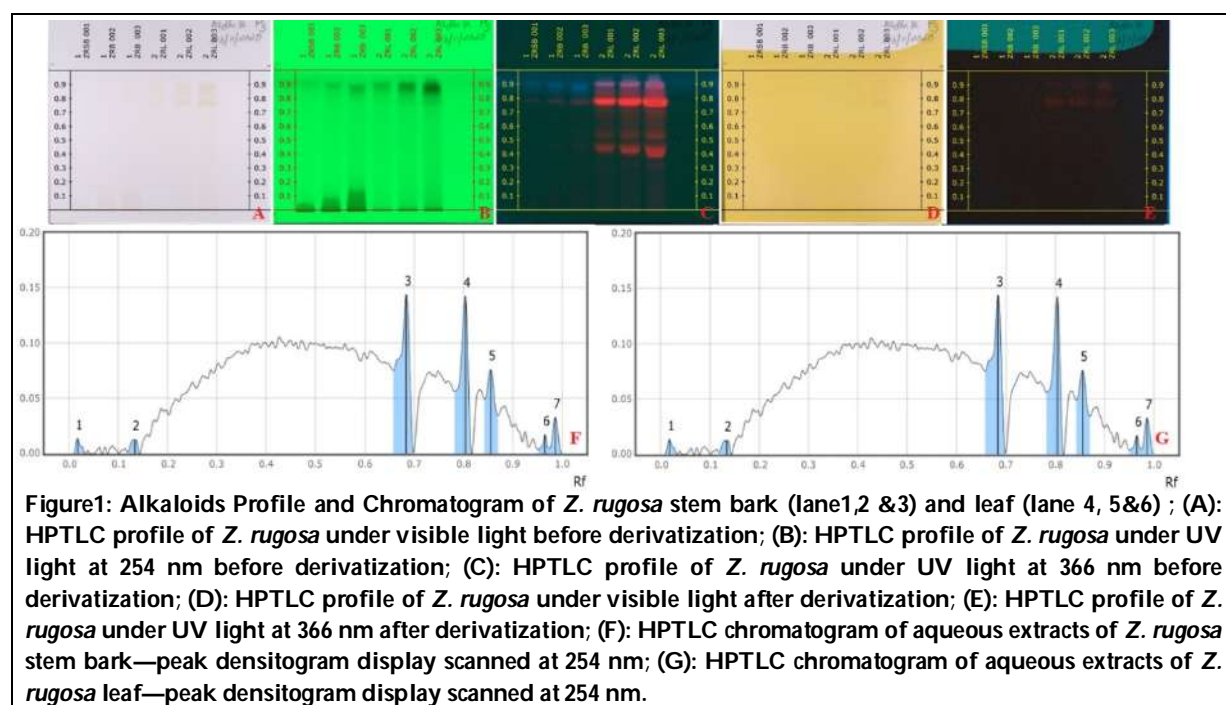




**Midhila Baby and Mathews.T.Thelly**

**Table 7: HPTLC Terpenoid profile of aqueous extracts of *Ziziphus rugosa* L. stem bark and leaf**

Part of <i>Z.rugosa</i>	Peak	Rf	Height	Area	Percentage area	Compound
Stem Bark	1	0.750	0.1625	0.00530	31.67	Terpenoid 1
	2	0.939	0.3646	0.01079	64.46	Unknown
	3	0.958	0.0581	0.00065	3.87	Unknown
Leaf	1	0.019	0.3248	0.01305	5.79	Terpenoid 1
	2	0.092	0.3356	0.01747	7.75	Terpenoid 2
	3	0.139	0.2728	0.01130	5.01	Terpenoid 3
	4	0.219	0.3040	0.01355	6.01	Terpenoid 4
	5	0.245	0.3087	0.01033	4.58	Terpenoid 5
	6	0.290	0.3226	0.02031	9.01	Terpenoid 6
	7	0.421	0.6919	0.04772	21.17	Unknown
	8	0.565	0.3285	0.02888	12.81	Unknown
	9	0.645	0.2389	0.01482	6.57	Unknown
	10	0.727	0.2502	0.00618	2.74	Unknown
	11	0.758	0.2992	0.00883	3.92	Unknown
	12	0.853	0.4040	0.01596	7.08	Terpenoid 7
	13	0.902	0.3058	0.01009	4.48	Terpenoid 8
	14	0.944	0.4164	0.00631	2.80	Terpenoid 9
	15	0.966	0.0532	0.00064	0.28	Unknown





Midhila Baby and Mathews.T.Thelley

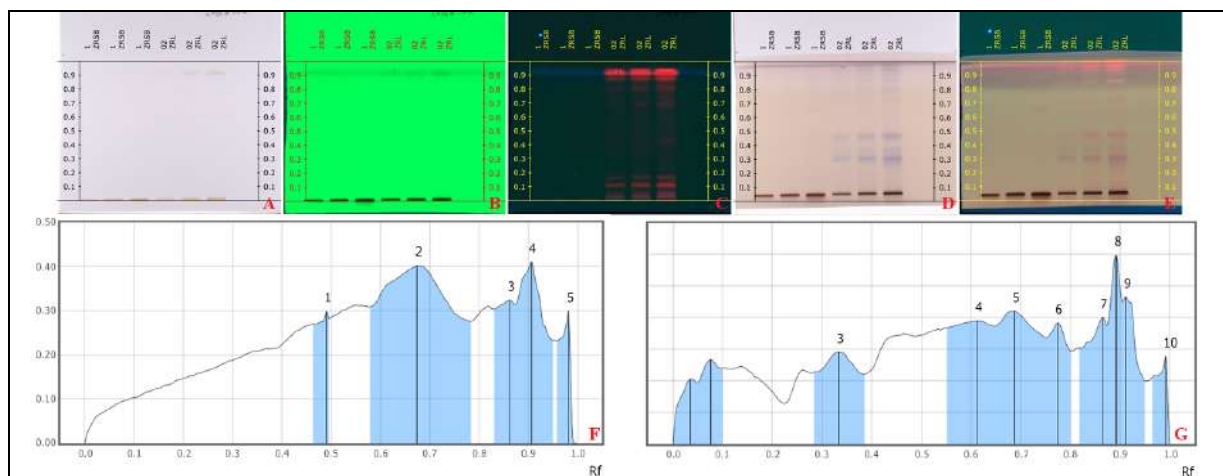


Figure 2: Steroid Profile and Chromatogram of *Z. rugosa* stem bark (lane 1,2 & 3) and leaf (lane 4, 5&6); (A): HPTLC profile of *Z. rugosa* under visible light before derivatization; (B): HPTLC profile of *Z. rugosa* under UV light at 254 nm before derivatization; (C): HPTLC profile of *Z. rugosa* under UV light at 366 nm before derivatization; (D): HPTLC profile of *Z. rugosa* under visible light after derivatization; (E): HPTLC profile of *Z. rugosa* under UV light at 366 nm after derivatization; (F): HPTLC chromatogram of aqueous extracts of *Z. rugosa* stem bark—peak densitogram display scanned at 366 nm; (G): HPTLC chromatogram of aqueous extracts of *Z. rugosa* leaf—peak densitogram display scanned at 366 nm.

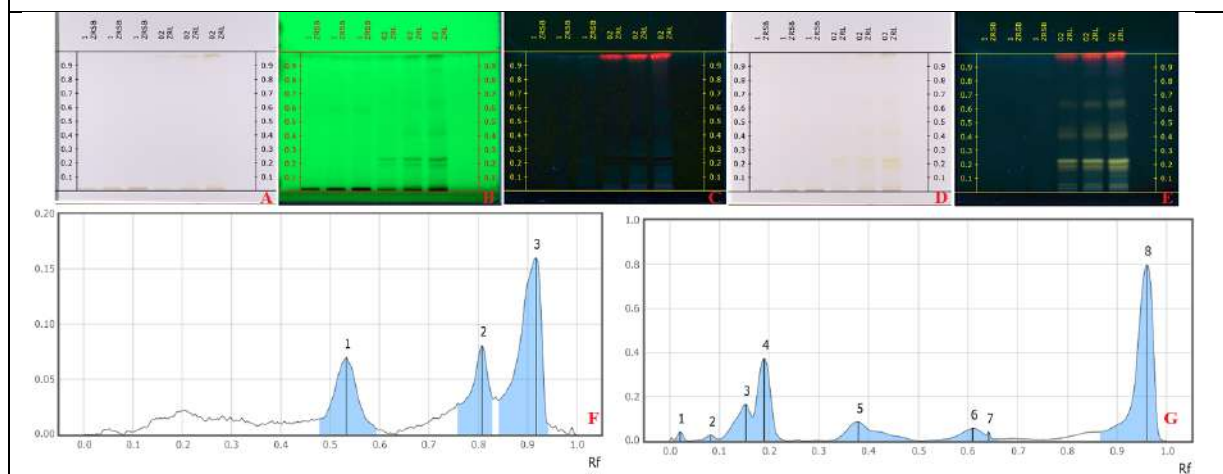
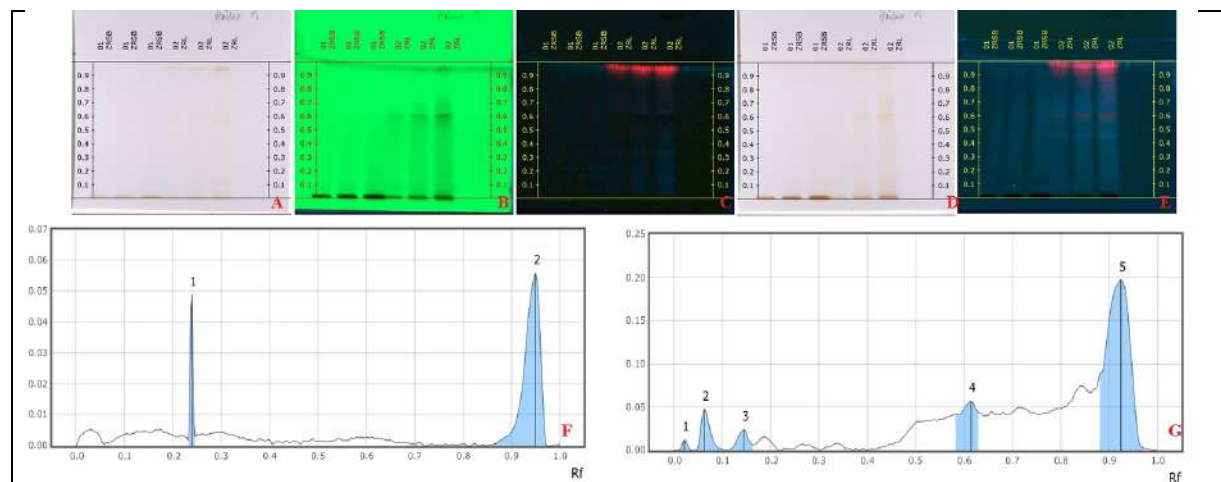


Figure 3: Flavonoid Profile and Chromatogram of *Z. rugosa* stem bark (lane 1,2 & 3) and leaf (lane 4, 5&6); (A): HPTLC profile of *Z. rugosa* under visible light before derivatization; (B): HPTLC profile of *Z. rugosa* under UV light at 254 nm before derivatization; (C): HPTLC profile of *Z. rugosa* under UV light at 366 nm before derivatization; (D): HPTLC profile of *Z. rugosa* under visible light after derivatization; (E): HPTLC profile of *Z. rugosa* under UV light at 366 nm after derivatization; (F): HPTLC chromatogram of aqueous extracts of *Z. rugosa* stem bark—peak densitogram display scanned at 254 nm; (G): HPTLC chromatogram of aqueous extracts of *Z. rugosa* leaf—peak densitogram display scanned at 366 nm.

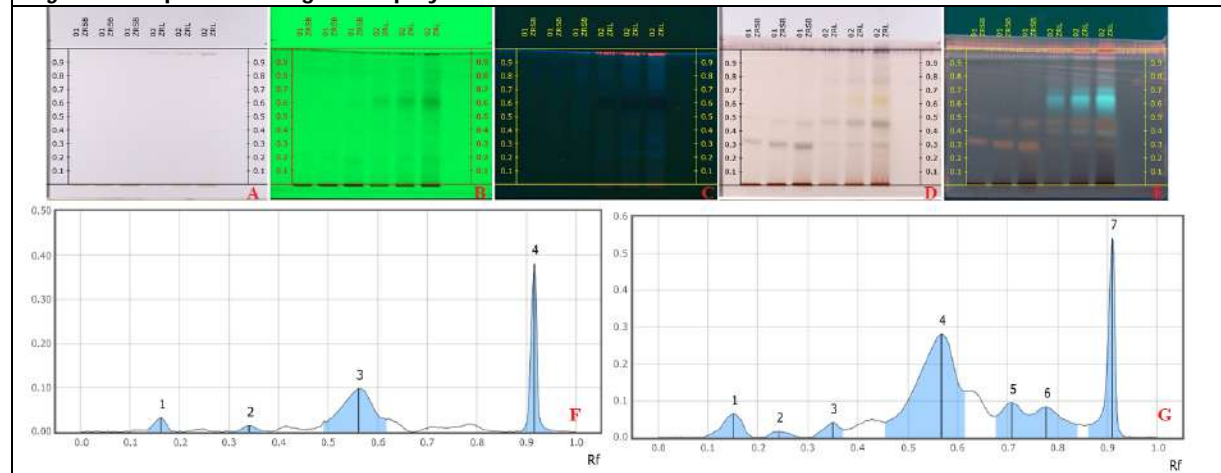




**Midhila Baby and Mathews.T.Thelly**



**Figure 4: Glycoside Profile and Chromatogram of *Z. rugosa* stem bark (lane 1,2 &3) and leaf (lane 4, 5&6); (A): HPTLC profile of *Z. rugosa* under visible light before derivatization; (B): HPTLC profile of *Z. rugosa* under UV light at 254 nm before derivatization; (C): HPTLC profile of *Z. rugosa* under UV light at 366 nm before derivatization; (D): HPTLC profile of *Z. rugosa* under visible light after derivatization; (E): HPTLC profile of *Z. rugosa* under UV light at 366 nm after derivatization; (F): HPTLC chromatogram of aqueous extracts of *Z. rugosa* stem bark—peak densitogram display scanned at 254 nm; (G): HPTLC chromatogram of aqueous extracts of *Z. rugosa* leaf—peak densitogram display scanned at 254 nm.**



**Figure 5: Saponin Profile and Chromatogram of *Z. rugosa* stem bark (lane 1,2 &3) and leaf (lane 4, 5&6); (A): HPTLC profile of *Z. rugosa* under visible light before derivatization; (B): HPTLC profile of *Z. rugosa* under UV light at 254 nm before derivatization; (C): HPTLC profile of *Z. rugosa* under UV light at 366 nm before derivatization; (D): HPTLC profile of *Z. rugosa* under visible light after derivatization; (E): HPTLC profile of *Z. rugosa* under UV light at 366 nm after derivatization; (F): HPTLC chromatogram of aqueous extracts of *Z. rugosa* stem bark—peak densitogram display scanned at 254 nm; (G): HPTLC chromatogram of aqueous extracts of *Z. rugosa* leaf—peak densitogram display scanned at 254 nm.**





Midhila Baby and Mathews.T.Thelly

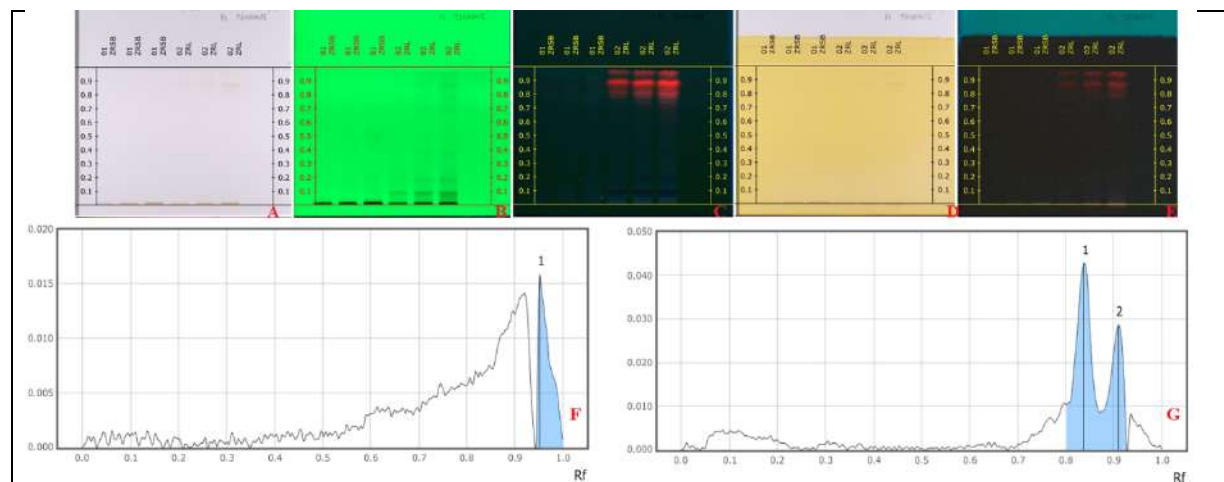


Figure 6: Tannin Profile and Chromatogram of *Z. rugosa* stem bark (lane1,2 &3) and leaf (lane 4, 5&6); (A): HPTLC profile of *Z. rugosa* under visible light before derivatization; (B): HPTLC profile of *Z. rugosa* under UV light at 254 nm before derivatization; (C): HPTLC profile of *Z. rugosa* under UV light at 366 nm before derivatization; (D): HPTLC profile of *Z. rugosa* under visible light after derivatization; (E): HPTLC profile of *Z. rugosa* under UV light at 366 nm after derivatization; (F): HPTLC chromatogram of aqueous extracts of *Z. rugosa* stem bark—peak densitogram display scanned at 366 nm; (G): HPTLC chromatogram of aqueous extracts of *Z. rugosa* leaf—peak densitogram display scanned at 366 nm.

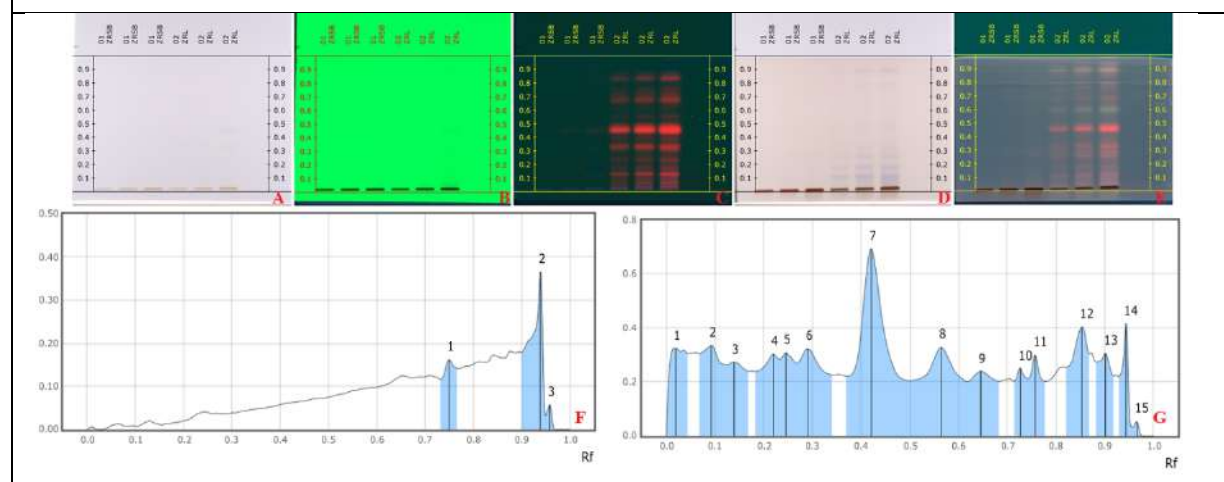


Figure 7: Terpenoid Profile and Chromatogram of *Z. rugosa* stem bark (lane1,2 &3) and leaf (lane 4, 5&6); (A): HPTLC profile of *Z. rugosa* under visible light before derivatization; (B): HPTLC profile of *Z. rugosa* under UV light at 254 nm before derivatization; (C): HPTLC profile of *Z. rugosa* under UV light at 366 nm before derivatization; (D): HPTLC profile of *Z. rugosa* under visible light after derivatization; (E): HPTLC profile of *Z. rugosa* under UV light at 366 nm after derivatization; (F): HPTLC chromatogram of aqueous extracts of *Z. rugosa* stem bark—peak densitogram display scanned at 366 nm; (G): HPTLC chromatogram of aqueous extracts of *Z. rugosa* leaf—peak densitogram display scanned at 366 nm.





## Pre-Monsoon and Post-Monsoon Study on the Analysis of Physio-Chemical Parameters, WQI, and Correlation Coefficient of River Yamuna at Prayagraj, Uttar Pradesh

Runit Isaac<sup>1\*</sup>, Shaziya Siddiqui<sup>2</sup>, Amit Chattree<sup>3</sup>, Prashant Anthony<sup>3</sup> and Prerna Higgins<sup>1</sup>

<sup>1</sup>Research Scholar, Department of Chemistry, Sam Higginbottom University of Agriculture Technology and Sciences, Prayagraj, U.P. India.

<sup>2</sup>Assistant Professor, Department of Chemistry, Sam Higginbottom University of Agriculture Technology and Sciences, Prayagraj, U.P. India.

<sup>3</sup>Associate Professor, Department of Chemistry, Sam Higginbottom University of Agriculture Technology and Sciences, Prayagraj, U.P. India.

Received: 28 Oct 2021

Revised: 17 Dec 2021

Accepted: 08 Jan 2022

### \*Address for Correspondence

#### Runit Isaac

Research Scholar,

Department of Chemistry,

Sam Higginbottom University of Agriculture Technology and Sciences,

Prayagraj, U.P. India.

Email: shalome.runit@gmail.com



This is an Open Access Journal / article distributed under the terms of the **Creative Commons Attribution License** (CC BY-NC-ND 3.0) which permits unrestricted use, distribution, and reproduction in any medium, provided the original work is properly cited. All rights reserved.

### ABSTRACT

Escalated anthropogenic activities and untreated industrial waste has put a lot of stress on the water bodies. Urbanization, Industrialization and technological advancement has increased the water pollution which further effects the marine ecosystem as well as humans on consumption. During the analysis and the study, Collection of 18 water samples was performed from nine locations of Yamuna River pre and post monsoon for the analysis of the seasonal variation effect on the quality status of river water. Total of fourteen parameters were inspected quarterly from May-Oct 2019 and statistical approach was implemented to find the relationship among the data. Comparative study was established among the parameters and the quality standard data of BIS and WHO. Study was formulated to identify the variation in the quality Yamuna River from different site.

**Keywords:** Water Quality Index (WQI), Biological Oxygen Demand (BOD), Chemical Oxygen Demand (COD), Correlation, Dissolved Oxygen (DO).

### INTRODUCTION

Water has the most important role to play in the biotic ecosystem, and also being the most prominent compound necessary for the survival of living beings and plants [1]. Naturally it is found as in river, lakes, stream, pond,







**Runit Isaac et al.,**

ground water, glacier etc. It plays a vital role in the development of the economic sectors such as agriculture, fisheries, hydropower and forestry. Due to industrial and domestic activities the water available for human use has been deteriorated because of rise in water pollution and overutilization. Yamuna river is the largest tributaries of Ganga and several developing metropolitan cities such as New Delhi, Noida, and Prayagraj are situated on its bank stretching 1376 km. Untreated industrial and sewage waste imbalances the physiochemical composition of water which directly effects the aquatic life resulting in increased WQI. Rise in water pollution is a great threat for today's world [2]. Physio chemical parameters helps to identify the physical and chemical composition of water. Water being a universal solvent has the capacity to dissolve innumerable substances. Electrical conductivity, pH, TDS, Turbidity, BOD, COD, DO, Fe, Ca+2, Mg+2, Cl-, Total Alkalinity, Sulphate and Total Hardness are the common parameters which are analysed accordingly with the values assigned by WHO[3] and BIS[4] to maintain the quality standards. Physiochemical parameters gives us the information about source of the polluting agent and the information of the type of pollutant and its effect on the marine ecology. The quality status is analyzed taking into consideration its chemical and physical constituents. Severe imbalances in the quality results in hazardous health effects on human. health [3,4,5,6]. It is always difficult to understand the imbalanced values of the parameters to identify the status of water [7,8]. WQI is the well-defined index which formulates calculated value of the parameters with the data into a single logical data [9]. The WQI of several rivers have been analyzed and the reported data suggests that due to lack of facilities provided by the local authorities to nearly all river have a grim plight that is life threatening to human life and aquatic system. These types of studies are implemented to measures, to protect and to clean the river water by local bodies and the government. The aim is to identify an analyze the physiochemical parameters using analytical techniques to get the WQI status and to establish the correlation of the parametric values.

## MATERIALS AND METHODS

### Water Quality Parameter

The protocol followed to collect the samples from sites was followed as per the APHA [10] guidelines from nine locations as seen in Figure-1. Sample collection was performed on the source where the runnel carrying untreated sewage was meeting the river stream. Before sunrise water samples to be analyzed was collected and kept in one liter of polyethylene bottles and were further refrigerated at 4°C to maintain its integrity. 10% of HNO<sub>3</sub> is refrigerating the sample to reduce precipitation and microbial activities. The location of the sampling sites was recorded through GPS. TDS, pH, EC and turbidity was analyzed by the instruments manufactured by Labtronics. Method of titration was used to analyze parameters such as Cl-, Alkalinity, Hardness, Magnesium, Iron and Calcium Gravimetric analysis identified the sulphate. After incubating the samples for 5 day BOD was identified whereas DO analysis was performed by the Winkler's method and COD by Closed reflux method. Analytical methods have been provided in the Table-1

### WQI Calculations

Weighted arithmetic index was used to compute the WQI [11]. Table-2 provides the WQI permissible values to identify the status of water:

Calculation according to BIS and WHO values.

$$Q_n = 100 \times \frac{V_n - V_i}{S_n - V_i}$$

$Q_n$  = nth parameter of the water quality rating

$V_n$  = nth parameter of the Observed value

$n$  = Standard Permissible value of the nth parameter

$V_i$  = nth parameter of the Ideal values

Unit Weight is denoted by ( $W_n$ )





**Runit Isaac et al.,**

$$W_n = \frac{K}{S_n}$$

Where the above variables are:

$W_n$  = nth parameter of the Unit weight

$S_n$  = nth parameter of the standard value

$K$  = Proportionality Constant

$K$  is calculate by the equation

$$K = \frac{1}{\sum \left( \frac{1}{S_n} \right)}$$

Total WQI was calculated by adding  $W_n$  and  $Q_n$  linearly.

$$WQI = \frac{\sum Q_n - W_n}{\sum W_n}$$

### Correlation Coefficient

Correlation coefficient presents the interdependence among the two sets of data and their linear relationship in negative and positive direction

Represented by the formula:

$$r = \frac{\sum (a_i - \bar{a})(b_i - \bar{b})}{\sqrt{\sum (a_i - \bar{a})^2 (b_i - \bar{b})^2}}$$

Where  $a_i$  and  $b_i$  are the values of the variable in the sample and  $\bar{a}$  and  $\bar{b}$  is regarded as the mean of the values of the variable a and b respectively.

## RESULT AND DISCUSSION

Variation in water parameters due to seasonal changes were reported as seen in pre monsoon in Table-3 and post monsoon in Table-4, And graphical representation in figure-2. The pH of the samples were seen moderately high in the alkaline region pre monsoon in the location S8, whereas the rest of the samples were near to neutral pH 7. Turbidity pre monsoon was equal or above NTU 7 in S2, S5, S8 and S9 location, post monsoon value was high of location S1 with 15 NTU being the highest. Comparative study specified that the TDS before monsoon was high comparing with the post monsoon values this can be because of reduced levels of water resulting in higher TDS makes water unsuitable for consumption purposes. EC has direct relation with the dissolved salts water, more the dissolved salts more is the conductivity. EC has a direct relationship with the dissolved salt in river water, the more the dissolved salt will carry free ions greater will be its conductivity. Pre-monsoon EC values appear to be slightly lower compared to post monsoon because during the rainy season the rainwater carries free ions from the land to the river body thus increasing the ionic load of the river, continuing to grow the electrical conductivity. BOD rating scores were similarly reported in both studies. The COD post monsoon was reported to be relatively high with an average value of 74.22 mg / L, while the pre-heavy rainfall was 64 mg / L.

The high post monsoon values of COD is because of the flow of organic matter is present, COD always indicates the amount of industrial and domestic organic waste present in the water body [12]. The DO is affected by temperature and salinity [13], which suggests more the salinity lower is the DO. The analysed values of the DO pre- and post-monsoon was in the range of 5.70–5.65 mg / L were similar. The high DO in river water is caused by factors such including mixing of fresh water and rainfall in river water [14,15]. The high DO value is a prominent factor for the respiratory system of the aquatic life. The total hardness was higher of the range of 591.33-666.11 mg / L which is more than the desired permissible limit, the increased amount of TA can be due to the existence of high levels of CaCO<sub>3</sub> present in water from natural sources such as soil and eroding of rocks such as limestone and chalk. Alkalinity plays a major role in reducing acid pollution caused by acid rain. Alkalinity compound is produced by



**Runit Isaac et al.,**

industrial waste, certain plants and rock salts, and offers great water potential to promote algae and several aquatic systems. The average alkalinity range in both seasons is 362.22-375.55 mg / L which is much high with respect to the value of 200mg / L according to BIS. This suggests that the industrial pollutants being dumped in the water untreated are causing an increase in the Total Alkalinity. Chloride levels are seen below 250mg / L (WHO) which is under the permissible limit, reason being the low salinity of river water. The iron content of less than 20mg / L in river water varies from 0.15-0.16 mg / L pre post monsoon respectively. The amount of  $Mg^{+}$  and  $Ca^{+2}$  is recorded at the top which also suggests that the total hardness has a direct relationship with calcium and magnesium compound concentration. In both studies Calcium Magnesium was 86.78, 87.05mg / L and 5.26 and 5.27mg / L respectively. The high sulphate yield was present post monsoon in the S2 area with a concentration of 385.7 mg / L determined by gravimetric analysis, rest all samples were under the permissibility range below 250mg / L, with an estimated value of 137.61mg /L in pre-monsoon conditions and 190.24 in post-monsoon conditions.

The WQI calculated of the locations are seen in Table-5. and it was deduced that the location S8 showed a very poor water quality along with location S9 which showed poor quality in both the seasons due to overutilization of river water for domestic purposes and bathing since these locations are near Sangam and religious bathing events are performed here time to time. S2 before monsoon and S5 post monsoon showed poor water quality. The rest of the sites showed a decent water status for ideal utilization. The correlation matrix is proposed as calculated in Table-6 showed that TDS is strongly associated with EC with a value of 0.841.  $Ca^{+2}$  and  $Mg^{+2}$  are strongly associated with Total Hardness with a value of 0.85. Sulphate shows moderate correlation with EC and Alkalinity.

## CONCLUSION

The deterioration of the river water has increased in the 20<sup>th</sup> century with a drastic rate. Rivers like Ganga and Yamuna needs an immediate action plan to increase the quality of water and for the betterment of the marine ecosystem. Water contamination can cause serious illness to the living organism dependent on it. This study gives an idea about the particular river waters or locations that needs to be treated.

## ACKNOWLEDGEMENT

My sincere thanks to the Department of Chemistry Sam Higginbottom University of Agriculture Technology and Sciences for helping me in planning out my experimentation.

## REFERENCES

1. India. Ind. J. Mar. Sci. **26**: 323-326. Agarwal BR, Vijay Mundhe, Sayyed Hussain, Vidyapradhan and Sayyed Yusuf (2013) Investigation of Heavy Metals In And Around Badnapur, dist. Jalna, IJAPBC, pp 120-122, Vol. 2(1)
2. Vodela JK, Renden, Lenz SD, MchelHenney WH, Kempainen BW (2001) Drinking water contaminants. Poult Sci 76: 1474-1492.
3. Guidelines for Drinking-water Quality, Fourth Edition, World Health Organization ISBN 978 92 4 154815 1. 2012.
4. Bureau of Indian Standards, Specification for drinking water. IS: 10500, New Delhi, India, 2012.
5. United State EPA 816-F-09-004, May 2009, <http://water.epa.gov/drink/contaminants/upload/mcl-2.pdf> (Accessed 12 July 2013).
6. Guide Manual: Water and Waste Water, Central Pollution Control Board, New Delhi. [http://www.cpcb.nic.in/upload/Latest/Latest\\_67\\_guidemanualw& wwanalysis.pdf](http://www.cpcb.nic.in/upload/Latest/Latest_67_guidemanualw& wwanalysis.pdf) (Accessed 12 July 2013).
7. Bharti, N. and Katyal, D, "Water quality indices used for surface water vulnerability assessment", Int. J. Environ. Sci., 2(1). 154- 173. 2011.





**Runit Isaac et al.,**

8. Akoteyon, I.S., Omotayo, A.O., Soladoye, O. and Olaoye, H.O., "Determination of water quality index and suitability of urban river for municipal water supply in Lagos-Nigeria", *Europ. J. Scientific Res*, 54(2). 263-271. 2011.
9. BabaeiSemiromi, F., Hassani, A.H., Torabian, A., Karbassi, A.R. and HosseinzadehLotfi, F., "Water quality index development using fuzzy logic: A case study of the Karoon river of Iran", *African J. Biotech.*, 10(50). 10125-10133. 2011.
10. American Public Health Association (APHA) Standard Methods for the Examination of Water and Wastewater (nineteenth ed.), American Public Health Association, Washington (1995)
11. R.M. Brown, N.I. Mc Clelland, R.A. Deininger, R.G. Tozer A water quality index: do we dare? *Water and sewage work*, 117 (1970), pp. 339-343
12. Ayati, B., 2003. Investigation of sanitary and industrial wastewater effects on Anzali Reserved Wetland (Final report). MAB-UNESCO, Tarbiat Modarres University, Iran, 53p.
13. Vijayakumar, S., K.M. Rajan, R. Mridula, Mendon and Hariharan 2000. Seasonal distribution and behavior of nutrients with reference to tidal rhythm in the Mulki estuary, southwest coast of India. *J. Mar. Biol. Ass. India* **42**: 21-24.
14. Das, J., S.N. Das and R.K. Sahoo 1997. Semidiurnal variation of some physicochemical parameters in the Mahanadi estuary, east coast of
15. Mitra, A., K.C. Patra and R.C. Panigrahy 1990. Seasonal variations of some hydrographical parameters in a tidal creek opening into the Bay of Bengal, Mahasagar. *Bull. Natn. Inst. Oceanogr.* **23**: 55-62.

**Table 1. Analytical methods for the detection of water quality parameters.**

No	Parameters	Units	Methods
1	Concentration of Hydrogen ions (pH)	pH units	pH meter
2	Biological Oxygen Demand (BOD)	mg L <sup>-1</sup>	Azide modification at 20 °C for 5days (APHA <i>et al.</i> , 2005)
3	Total Dissolved Solids (TDS)	mg L <sup>-1</sup>	TDS meter
4	Electrical Conductivity (EC)	μS cm <sup>-1</sup>	Conductivity meter
5	Iron (Fe)	mg L <sup>-1</sup>	Titration
6	Total Alkalinity (TA)	mg L <sup>-1</sup>	Titration
7	Total Hardness (TH)	mg L <sup>-1</sup>	Herner's method
8	Chloride (Cl)	mg L <sup>-1</sup>	Mohr method
9	Chemical Oxygen Demand (COD)	mg L <sup>-1</sup>	Reflux Dichromate method (APHA <i>et al.</i> , 2005)
10	Calcium (Ca)	mg L <sup>-1</sup>	Titration by EDTA
11	Sulphate (SO <sub>4</sub> <sup>2-</sup> )	mg L <sup>-1</sup>	Gravimetric method
12	Magnesium (Mg)	mg L <sup>-1</sup>	Titration by EDTA
13	Turbidity	NTU	Turbidity meter
14	Dissolved Oxygen	mg L <sup>-1</sup>	Winkler's Iodometric method (APHA <i>et al.</i> , 2005)

**Table 2. Water Quality Classification based on WQI values**

Class	WQI Value	Water Quality Status
A	<50	Excellent
B	51-100	Good
C	101-200	Poor Water
D	201-300	Very Poor Water
E	>300	Water unsuitable for drinking





Runit Isaac et al.,

Table 3. Parametric values of the monitoring station in Pre Monsoon 2019

Parameters	CHADODI GHAT			ABHAICHANDPURGHAT			ARAILGHAT			Mean Value
Sample Name	S1 ●	S2 ○	S3 ●	S4 ■	S5 ■	S6 ■	S7 ●	S8 ●	S9 ●	
Depth (cm)	22	26	24	24	22	28	25	25	26	
pH	7.42	7.80	7.21	7.19	7.72	7.39	7.76	8.21	7.83	7.61
Turbidity (NTU)	03	12	07	04	08	05	06	08	08	6.77
TDS (mg/L)	346	570	499	431	505	461	417	563	509	477.88
EC (µS/Cm)	512	633	591	486	600	539	511	732	617	580.11
BOD (mg/L)	2.99	3.15	2.03	2.61	3.29	3.03	2.31	3.56	3.33	2.992
COD (mg/L)	32	128	64	64	96	32	32	96	32	64
Total hardness(mg/L)	449	657	477	501	588	541	512	835	762	591.33
Iron (mg/L)	0.11	0.16	0.16	0.11	0.22	0.16	0.16	0.22	0.22	0.16
Total Alkalinity (mg/L)	385	450	340	300	385	260	350	510	400	375.55
Sulphate(mg/L)	126.28	169.02	128.11	111.03	132.65	89.6	139.22	190.45	152.13	137.61
Chlorides(mg/L)	269.42	155.98	269.42	226.88	127.62	269.42	184.34	241.06	184.34	214.27
Calcium (mg/L)	72.4	87.2	83.61	80.8	81.01	83.61	86.41	109.6	96.41	86.78
Magnesium(mg/L)	4.38	5.28	5.06	4.89	4.91	5.06	5.23	6.64	5.84	5.26
DO (mg/L)	6.6	6.2	5.2	5.8	6.8	6.0	5.4	4.8	4.5	5.7

Table 4. Parametric values of the monitoring station in Post Monsoon 2019

Parameters	CHADODI GHAT			ABHAICHANDPUR GHAT			ARAIL GHAT			Mean Value
Sample Name	S1 ●	S2 ○	S3 ●	S4 ■	S5 ■	S6 ■	S7 ●	S8 ●	S9 ●	
Depth (cm)	24	20	23	21	23	25	23	25	20	
pH	7.15	7.0	6.60	7.38	7.21	7.45	7.30	7.25	7.25	7.17
Turbidity (NTU)	15	04	05	02	03	02	01	05	01	4.22
TDS (mg/L)	332	555	390	343	542	348	401	570	586	451.89
EC (µS/Cm)	484	828	574	500	800	502	584	846	874	665.78
BOD (mg/L)	3.46	1.63	2.58	5.32	1.42	3.63	3.60	2.74	1.90	2.92
COD (mg/L)	64	64	32	32	32	124	96	128	96	74.22
Total hardness(mg/L)	635	590	560	740	855	815	660	555	585	666.11
Iron (mg/L)	0.16	0.22	0.16	0.16	0.11	0.11	0.11	0.22	0.16	0.15
Total Alkalinity (mg/L)	255	465	430	255	485	365	360	285	360	362.22
Sulphate(mg/L)	133.8	385.7	181.1	115.22	174.80	165.84	190.60	166.41	198.76	190.24
Chlorides(mg/L)	141.80	212.7	170.16	170.16	354.50	198.52	170.16	241.06	141.80	200.09
Calcium (mg/L)	89.6	87.21	76.41	96.01	101.41	104.8	88.01	70.82	69.21	87.05
Magnesium(mg/L)	5.43	5.28	4.63	5.82	6.14	6.35	5.33	4.29	4.19	5.273
DO (mg/L)	5.0	5.6	3.2	5.8	6.6	5.4	6.4	6.8	6.1	5.65





**Runit Isaac et al.,**

**Table 5. Water Quality Classification based on WQI values of monitoring areas**

Locations	Season	WQI	Category
<b>S1</b> Longitude: 81°85'62.99'' Latitude: 25°42'33.69''	Summer	51.47	Good
	Monsoon	86.25	Good
<b>S2</b> Longitude: 81°85'67.86'' Latitude: 25°42'34.12''	Summer	86.78	Good
	Monsoon	190.36	Poor Water
<b>S3</b> Longitude: 81°85'65.36'' Latitude: 25°42'34.18''	Summer	98.56	Good
	Monsoon	66.90	Good
<b>S4</b> Longitude: 81°87'63.43'' Latitude: 25°42'31.47''	Summer	40.85	Excellent
	Monsoon	6.88	Excellent
<b>S5</b> Longitude: 81°87'66.69'' Latitude: 25°42'29.19''	Summer	193.28	Poor Water
	Monsoon	38.44	Excellent
<b>S6</b> Longitude: 81°87'64.45'' Latitude: 25°42'29.57''	Summer	80.62	Good
	Monsoon	51.15	Good
<b>S7</b> Longitude: 81°88'24.46'' Latitude: 24°42'12.31''	Summer	81.52	Good
	Monsoon	50.89	Good
<b>S8</b> Longitude: 81°88'28.57'' Latitude: 25°42'11.35''	Summer	214.52	Very Poor Water
	Monsoon	203.33	Very Poor Water
<b>S9</b> Longitude: 81°88'26.80'' Latitude: 25°42'11.72''	Summer	197.58	Poor Water
	Monsoon	101.32	Poor Water

**Table 6. Correlation matrix of the analyzed parameters**

	pH	Turbidity (NTU)	TDS (mg/L)	EC (µS/Cm)	BOD (mg/L)	COD (mg/L)	Total hardness (mg/L)	Iron (mg/L)	Total Alkalinity (mg/L)	Sulphate (mg/L)	Chlorides (mg/L)	Calcium (mg/L)	Magnesium (mg/L)	DO (mg/L)
<b>pH</b>	1													
<b>Turbidity (NTU)</b>	0.2960	1												
<b>TDS (mg/L)</b>	0.2600	0.08539	1											
<b>EC (µS/Cm)</b>	-0.0445	-0.1855	0.842	1										
<b>BOD (mg/L)</b>	0.3452	0.09260	-0.51	-0.5348	1									
<b>COD (mg/L)</b>	0.2397	0.1099	0.367	0.3267	0.0881	1								
<b>Total hardness (mg/L)</b>	0.3599	-0.0040	0.112	0.1940	0.3165	0.1616	1							
<b>Iron (mg/L)</b>	0.3135	0.39371	0.546	0.4379	0.0220	0.1567	0.0483244	1						
<b>Total Alkalinity (mg/L)</b>	0.2367	0.01001	0.482	0.4611	-0.378	0.0943	0.4010373	0.168	1					
<b>Sulphate (mg/L)</b>	-0.2202	-0.1574	0.410	0.6257	-0.4103	0.1993	0.1494811	0.3297	0.56299	1				
<b>Chlorides (mg/L)</b>	-0.0749	-0.2719	0.171	0.2035	-0.4117	-0.3083	0.0678373	-0.258	0.19410	-0.05548	1			
<b>Calcium (mg/L)</b>	0.4611	0.12698	-0.07	-0.121	0.33419	-0.0098	0.8521122	-0.001	0.34259	0.0689407	0.1765351	1		
<b>Magnesium (mg/L)</b>	0.4607	0.12767	-0.07	-0.121	0.3364	-0.0087	0.85313402	-0.000	0.3417439	0.06882148	0.17391035	0.9999	1	
<b>DO (mg/L)</b>	0.1776	-0.2564	0.228	0.238	-0.0492	0.3247	-0.1078925	-0.171	-0.16312	-0.082552	0.20672549	-0.2352	-0.2359724	1





Runit Isaac et al.,

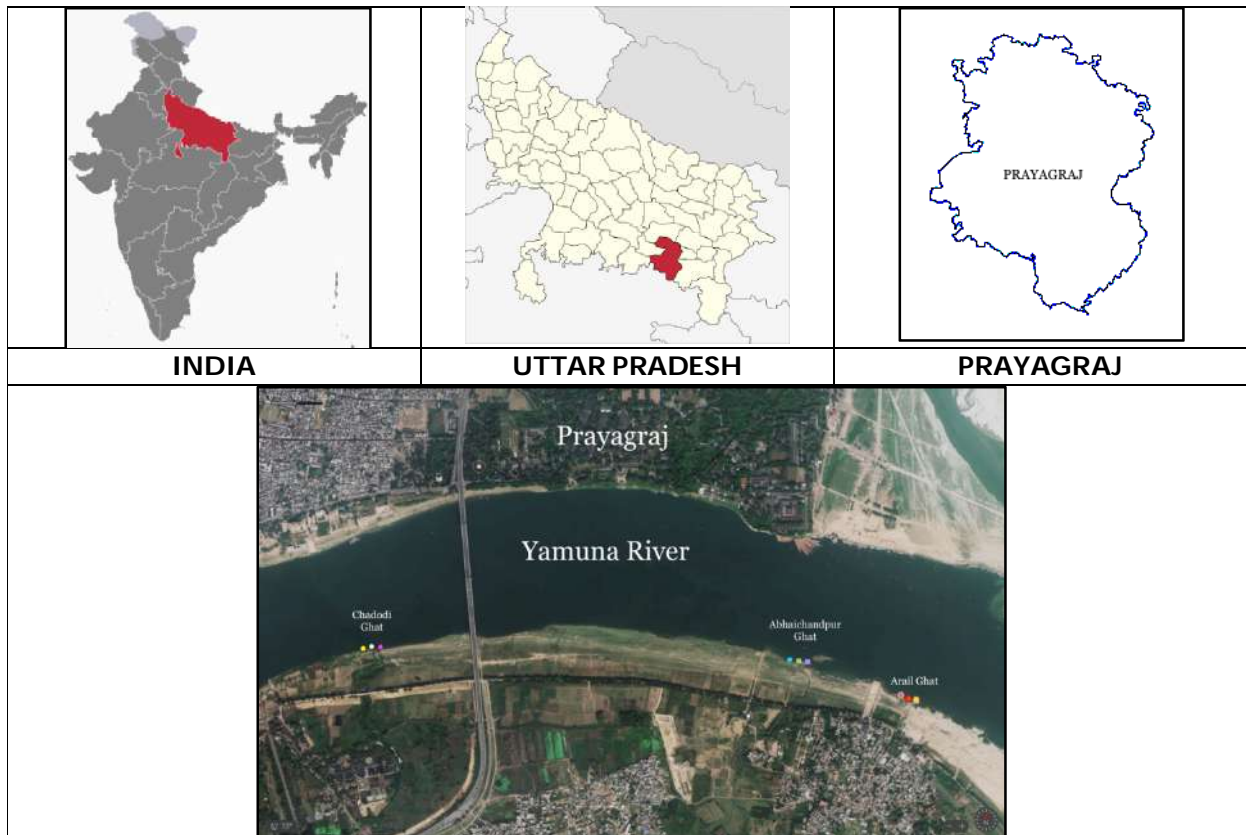
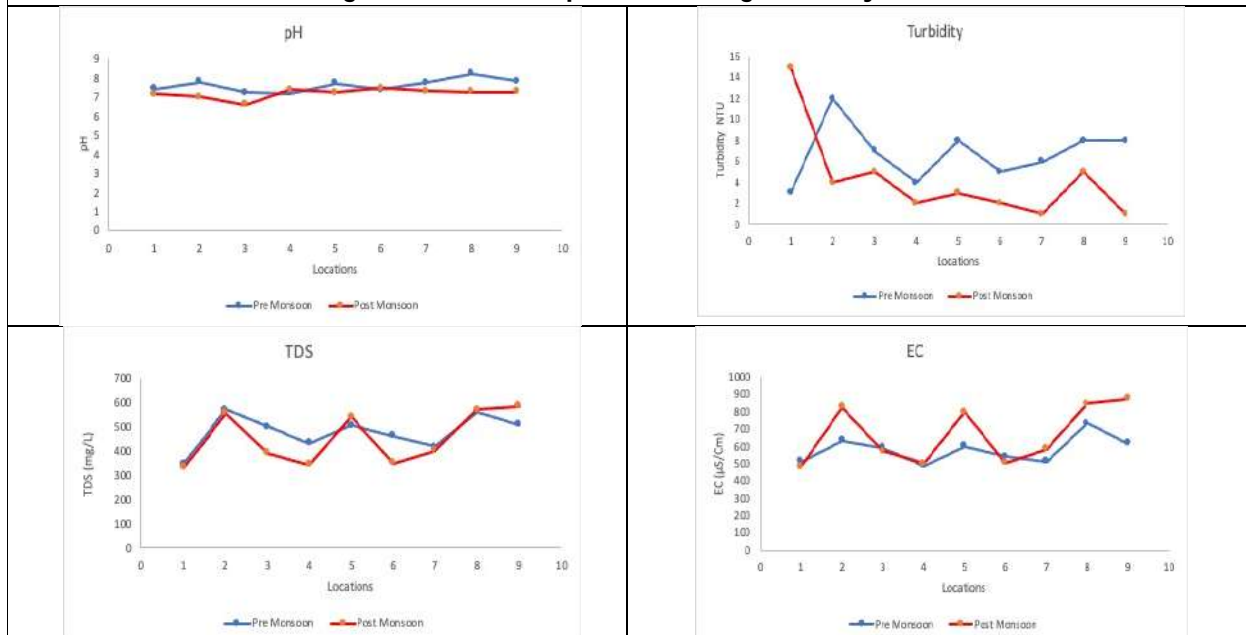


Figure 1. location map of monitoring and study area





Runit Isaac et al.,

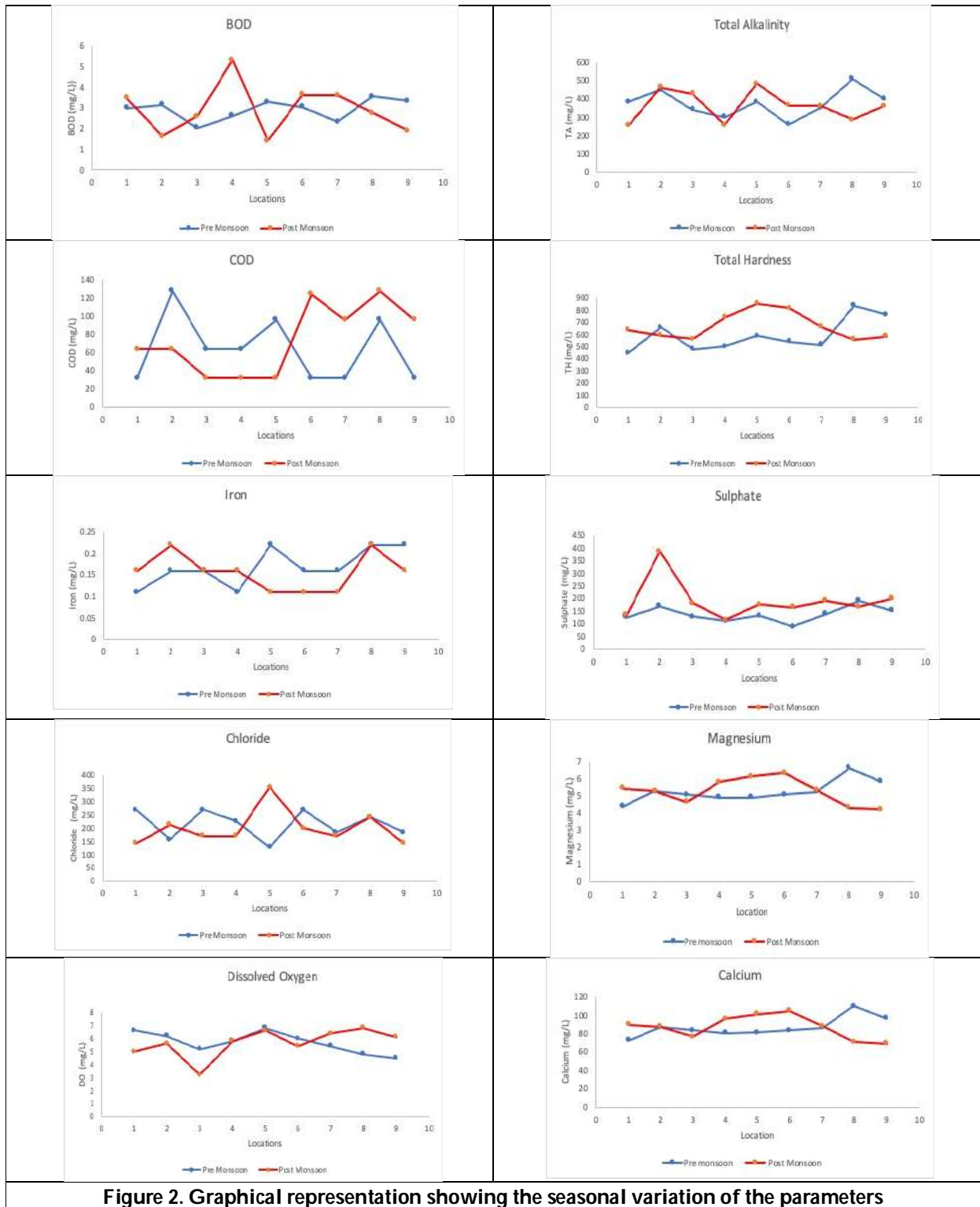


Figure 2. Graphical representation showing the seasonal variation of the parameters







## Building Performance Model of Processors in Modern HPC Platforms using Machine Learning Techniques

Hind Taha Al-Hashimi\* and Abdullah Basuhail

Department of Computer Science, Faculty of Computing and Information Technology, King Abdulaziz University, Jeddah 21589, Saudi Arabia.

Received: 23 Nov 2021

Revised: 26 Dec 2021

Accepted: 11 Jan 2022

### \*Address for Correspondence

#### Hind Taha Al-Hashimi

Department of Computer Science,  
Faculty of Computing and Information Technology,  
King Abdulaziz University,  
Jeddah 21589, Saudi Arabia.  
Email: hthashimi@gmail.com



This is an Open Access Journal / article distributed under the terms of the **Creative Commons Attribution License** (CC BY-NC-ND 3.0) which permits unrestricted use, distribution, and reproduction in any medium, provided the original work is properly cited. All rights reserved.

### ABSTRACT

The accuracy and adequacy of the performance profile of a data parallel application in modern high-performance systems are of paramount importance for the optimization. Performance models composing the performance profile represent the speed of each processor as a function of problem size. The process of building a full-speed function for each processing unit is highly expensive because, for each point in the model, the application is executed multiple times, then, the sample means of the execution times is calculated. To reduce the time cost, we propose a technique using machine learning (ML) to build a full performance model. Our approach has three steps: (i) building part of the performance model empirically for each processor, (ii) building the prediction model based on the first part, then (iii) using the prediction model to predict the rest of the performance model. The effectiveness of our approach is validated experimentally using the performance profiles of three popular heterogeneous data parallel applications, namely, matrix multiplication, the Jacobi method and Fast Fourier Transform (FFT). We implement an optimization algorithm that takes performance models as an input to map suitable chunk sizes to available processors in a heterogeneous system based on performance models. The obtained experiment results show that, for the target environment and by using the partially predicted performance model, the partitioning algorithm can return either identical results to those derived when using the full measured performance model, similar results (which not violate the goal of optimization), or slightly different results.

**Keywords:** Machine learning; performance model; HPC; heterogeneous systems; performance optimization; multicore CPU; GPU.





Hind Taha Al-Hashimi and Abdullah Basuhail

## INTRODUCTION

Recently, heterogenous HPC platforms, consisting of multi core CPU and accelerators integrated on a single node, have become common in addressing concerns of performance and energy consumption[1],[2], and [3].The integration of heterogenous processing units (PUs)adds additional challenges when optimizing the performance of a data parallel application. KHALEGHZADEH et al. [1]summarized these challenges as: shared resource contention (such as that in High-Level Cache),DRAM memory controllers, on-chip interconnection networks, and shared nodal PCI-E links and DRAM. These complexities, represented by the complex behavior of PUs on different workload sizes, make the performance profiles of data parallel applications executed on these systems non-linear and non-smooth [2]. Building an adequate and accurate performance models (PMs) for a data parallel application executing on modern HPC platforms is of paramount importance for the optimization of scientific applications[1]and [3]. In general, data partitioning techniques, with the purpose of minimizing execution times and energy consumption, are based on performance models of PUs[4].The performance of the application on each PU is represented by a function of speed against the workload size. This is application- and platform-specific. It must be built sufficiently accurately to guarantee correct partitioning results. The methodology for building an accurate PM for heterogenous system is described in [1].We describe it briefly in “material and methods” section.

However, building a full model is expensive and takes a lot of time. This is because, the application is executed multiple times for each data point in the model to calculate the sample means of the execution times. To reduce this time cost, we propose an ML-based approach to build a full PM. This approach builds part of the model empirically, then uses this part to build a prediction model using ML techniques, and finally, uses the prediction model to predict the remaining part and complete the PM. We work with a hybrid node, consisting of an accelerator and multicore CPU, in AZIZ Super computer to build the performance profiles of two important data parallel applications: matrix multiplication and Jacobian solver. From this process, and from the performance profiles of heterogeneous matrix multiplication and FFT performed on a multi-accelerator node achieved by [1], we conclude the following: a) Despite the existence of fluctuations in the PM, the relationship between the execution time and data size is positively correlated for most data points. This becomes more evident as the data size increases. Figures 1, 2 and 3 support this observation. This raises the possibility of predicting a part of the PM. b) The fluctuation is not constant and differs within a specific range each time the application is run with the same data size. This means that as the performance profile becomes more fine-grained, the optimal solution to the PM-based data partitioning problem of minimizing the execution time can be described with a specific range of data sizes, which may be mapped to each processor, and not only with a single specific shape of distribution. This observation is verified in[5]. This increases the probability of the success of the ML-based approach. That is, when the optimization algorithm is run based on the predicted PMs, the obtained solution may exist within this specific range. Because of these two observations, we believe that it is possible to save a lot of time by building the PM with ML prediction techniques.

This paper is organized as follows: A description of the proposal is given in “material and methods” section. The experimental results are shown in “experiment results and discussion section”, and “conclusions” section concludes.

## MATERIALS AND METHODS

The flow chart in Figure 4 illustrates our approach briefly. We discuss each main step in detail in the following.

### Building partial PM

To build an accurate full PM for each PU in a reasonable time, we first build part of the model empirically. We use the method described by [1], as below. For P heterogeneous processors, each processor, consisting of one or more CPU cores executing one multithreaded computational kernel, is modeled by one abstract processor. The accelerator usually depends on the host process, which launches the kernel and handles the data transformation between the accelerator and host (e.g., it is responsible for copying data from the host to the accelerator, kernel call, and sending the data back from the accelerator to the host). Therefore, each accelerator with a host core is modeled by one





### Hind Taha Al-Hashimi and Abdullah Basuhail

abstract processor. PMs of abstract processors consisting of a set of discrete data points. The points are built empirically by timing the execution of the application for a range of problem sizes. These data points are stored to and can be read from text file. PMs of processors are constructed simultaneously to consider shared resources contention. To ensure the PM's adequacy, i.e., containing enough information to build the prediction model, we constructed it to be fine-grained. For example, for matrix multiplication, constructing fine-grained PMs involves measuring the execution time for problem sizes  $x_1 \times n_1, x_2 \times n_1, \dots, n_1 \times n_1, x_1 \times n_2, x_2 \times n_2, \dots, n_2 \times n_2, \dots, etc.$ , where  $x_i < n_j$ . The size of this part of the PM is set to  $\leq 50\%$  of the total size. For example, in the matrix multiplication application, if the total size of the PM is 20000, the first part consists of consecutive data sizes  $\{x_1 \times n, x_2 \times n, \dots, x_{9800} \times n\}$  along with their execution times.

#### Building the prediction model

The PM built in the first step is used as input for the regression, used to build the prediction model. From this dataset, the target variable is the execution time ( $x$ ), which depends on the input feature, the problem size  $x$ . Because of the nature of the relationship between data sizes and execution time for most of the data points in the performance profiles of data parallel applications on a modern HPC, we decided to use the linear regression approach, where the traditional slope-intercept form is used to model the relationship. The relationship between  $x$  and  $T(x)$  is as follows:  $T(x) = \alpha x + \beta$  (1). The results of the model accuracy calculation performed on this part prove that the correlation between most of the points is positive. The largest value obtained is approximately 98%, while the smallest value is approximately 70%.

#### Predicting the PM

The remaining consecutive problem sizes are used as input into the prediction model to predict their execution times. Then, the estimated results along with their problem sizes are appended to the first part to complete the PM

### EXPERIMENT RESULTS AND DISCUSSION

In this section, we validate our approach using different data sizes. We target modern HPC systems, and the data parallel applications executed on them. We perform our experiments on two nodes of AZIZ supercomputer. One of them consists of an NVIDIA Tesla K20<sup>®</sup> GPU and a multicore CPU, while the second node consists of an Intel<sup>®</sup> Xeon Phi accelerator and a multicore CPU. Table 1 and 2 show the specifications of the GPU and CPU, respectively, of the first node. Two platforms are composed from the previous nodes for the experiment. Platform 1 contains: (1) CPU from the GPU node "called CPUK20", (2) GPU and its host core, (3) CPU from the Xeon phi node "called CPUPHI", and (4) Xeon Phi accelerator and its host core. Platform 2 consists of three processing units: (1) CPUPHI, (2) Xeon Phi accelerator and its host core, and (3) CPUK20. We experiment with three scientific applications: matrix multiplication, the Jacobi method, and FFT. Matrix multiplication is configured for execution on Platform 1. The time functions composing its performance profile are fine-grained set of discrete data points. They are built simultaneously on Platform 1. To ensure the reliability of the obtained outcomes, the measurements are repeated multiple times. The same methodology is followed to build the time functions of the Jacobi method on Platform 2. The time functions of FFT were built by [1] on a multi-accelerator node, i.e., a node containing CPU, GPU, and Xeon phi accelerators [6]. The specifications of this platform are described in [1] in detail.

We build a partially predicted PM using the ML-based approach. We take  $\leq 50\%$  of the actual measured PM and use it as a dataset for ML linear regression to build the prediction model. The sizes of the rest of the data points in the PM are passed on to the prediction model. The predicted result are then appended to the first data points. The optimization algorithm of [5], based on the PMs and converged to an optimal solution, is used to validate this approach. The algorithm works iteratively to map a suitable chunk size to each processor in a heterogeneous platform, which leads to the minimal parallel execution time of the application. To test the efficiency of using the ML-based approach for building a full PM, the algorithm is first executed based on the actual measured PM and is then executed based on the partial predicted PM. We then compare the results of both. The results obtained when using the partial predicted PM are identical or similar to the result obtained when using the actual PM, for both matrix multiplication and the Jacobi method (Figures 5 and figure 6). Based on observation (b) in "Introduction", the



**Hind Taha Al-Hashimi and Abdullah Basuhail**

similarity in the results does not mean that the prediction results violate the goal of optimization. That is, when running the optimization algorithm based on a partially predicted PM, it still converges to an optimal solution. For FFT, the estimated PMs lead to slight differences for some points (Figure 7). This may be because the data set used, i.e., the first part of the performance profile, is coarse-grained. Using a more fine-grained dataset may improve the estimation results. The experiment results, illustrated in Figure 8, compared to the results obtained in Figure 5, support this viewpoint. We constructed the coarse-grained PMs for processors on Platform 1 using data sizes  $N^2$ . We used the ML-based approach to build the partially predicted coarse-grained PMs. We notice a slight difference in the estimated parallel execution times when using partly predicted PMs versus full measured PMs. Therefore, using fine-grained data sets means more information is available for building the prediction model, hence offering more accurate results. For the identical results obtained for the data size  $16000^2$ , this is because the optimization algorithm only searches the first part of the PM, i.e., the actual measured part, only before it can find the solution. We believe that the obtained ML-based estimation results, and the optimization results based on them, offer more opportunities for investigations in this area, possibly with differences in the parameters, such as the target environment, problem sizes, and the type of ML algorithm used.

**CONCLUSIONS**

In this paper, we proposed an ML-based approach to minimize the cost of building a full PM of processors on heterogeneous HPC systems for data parallel applications. The efficiency of the proposed approach has been demonstrated via experiments on the performance profiles of three data parallel applications—matrix multiplication, the Jacobi method, and FFT—built on heterogeneous platforms. We used an optimization algorithm based on the PMs of the processors as an input to map suitable chunk size onto the available processors in a heterogeneous system to minimize the application's parallel execution time. The results of optimization using the proposed approach were identical to, similar to, or slightly different from the results obtained when using the actual PM. Using the partially predicted PM, the optimization algorithm was able to converge on the optimal solution. The similarity between the results of the two methods will not undermine the goal of optimizing data parallel applications. Because of the complexities exhibited by modern HPC systems, data parallel applications exhibit differently shaped fluctuations, represented by a set of similar execution times for the same problem size.

In cases when the results were different, this may have been due to the use of a coarse-grained dataset—using more fine-grained data to build the prediction model will offer more information for improving the results. In general, the prediction results obtained for all three applications encourage more investigations in this area.

**ACKNOWLEDGEMENTS**

All presented experiments were supported by King Abdulaziz University's High-Performance Computing HPC Center - AZIZ supercomputer - (<http://hpc.kau.edu.sa>).

**REFERENCES**

1. H. Khaleghzadeh, R. R. Manumachu, and A. Lastovetsky, "A Novel Data-Partitioning Algorithm for Performance Optimization of Data-Parallel Applications on Heterogeneous HPC Platforms," *IEEE Trans. Parallel Distrib. Syst.*, vol. 29, no. 10, pp. 2176–2190, 2018.
2. H. Khaleghzadeh, R. R. Manumachu, and A. Lastovetsky, "A Hierarchical Data-Partitioning Algorithm for Performance Optimization of Data-Parallel Applications on Heterogeneous Multi-Accelerator NUMA Nodes," *IEEE Access*, vol. 8, pp. 7861–7876, 2020.
3. A. Lastovetsky and R. Reddy Manumachu, "New Model-Based Methods and Algorithms for Performance and Energy Optimization of Data Parallel Applications on Homogeneous Multicore Clusters," *IEEE Trans. Parallel Distrib. Syst.*, vol. 28, no. 4, pp. 1119–1133, 2017.





**Hind Taha Al-Hashimi and Abdullah Basuhail**

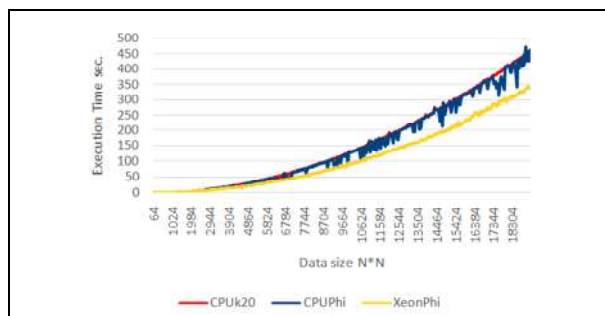
4. Z. Zhong, V. Rychkov, and A. Lastovetsky, "Data partitioning on heterogeneous multicore and multi-GPU systems using functional performance models of data-parallel applications," Proc. - 2012 IEEE Int. Conf. Clust. Comput. Clust. 2012, pp. 191–199, 2012.
5. H. T. Al-Hashimi and A. A. Basuhail, "A Proposed Data Partitioning Approach on Heterogeneous HPC Platforms: Data Locality Perspective," IEEE Access, vol. 9, pp. 81432–81442, 2021.
6. "HamidrezaKhaleghzadeh \_ HPOPT · GitLab." .

**Table 1. Specifications of Nvidia K20m GPU.**

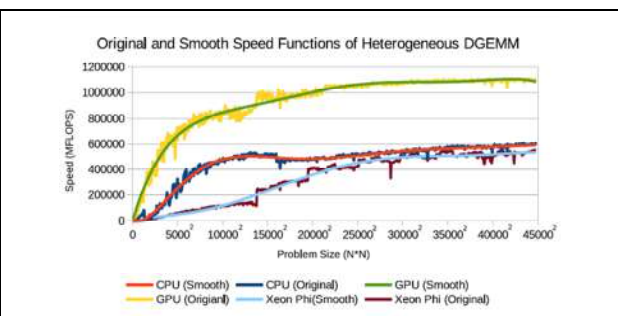
Technical Specification	
Number of Cores	2496
Clock Rate	705 MHz
Boost Clock	TBD
Memory Clock Rate	2600 MHz
Memory Bus Width	320 bits
L2 Cache Size	1310720 bytes
TDP	225 W
Memory size per board (GDDR5)	5 GB
Bandwidth	208 GB/s

**Table 2. Specifications of intel Xeon CPU E5-2695 V2 2.40GHz.**

Technical Specification	
CPUs	24
Cores per socket	12
Sockets	2
NUMA nodes	2
CPU MHz	2399.842
L1d cache	32K
L1i cache	32K
L2 cache	256K
L3 cache	30720K



**Figure 1.** Time functions of heterogenous Jacobi method executed on a platform composed of two hybrid nodes, each equipped with a multicore CPU and an accelerator. This illustrates that the correlation between the execution time and data size is positive for most data points.

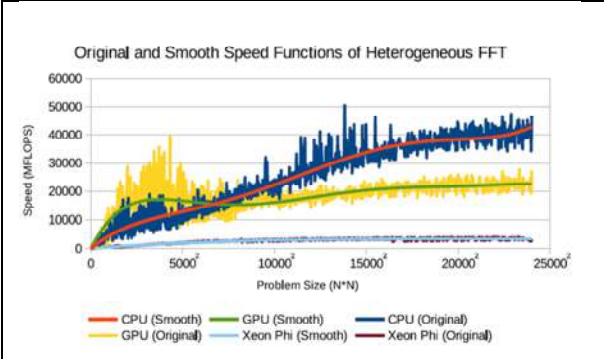


**Figure 2.** Speed functions of heterogenous matrix multiplication built on a multi-accelerator node by [1]. This illustrates that in the equivalent time function, the correlation between the execution time and the data size is positive for most data points

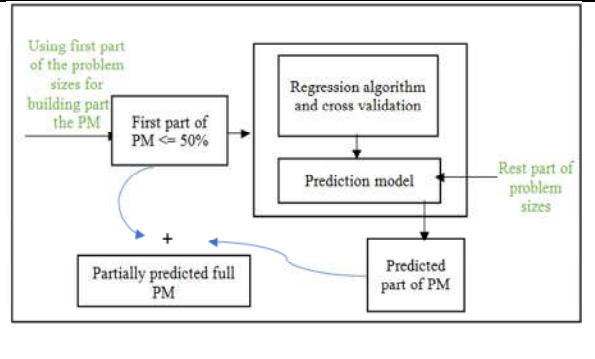




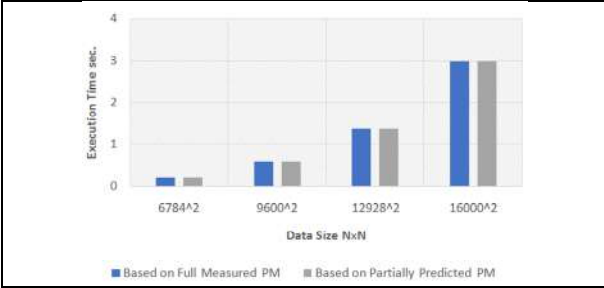
**Hind Taha Al-Hashimi and Abdullah Basuhail**



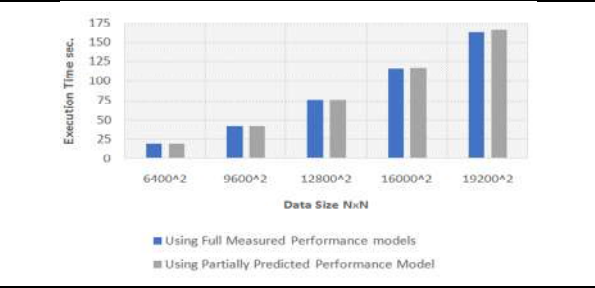
**Figure 3. Speed functions of heterogenous FFT built on a multi-accelerator node by [1]. This illustrates that in the equivalent time function, the correlation between the execution time and data size is positive for most data points.**



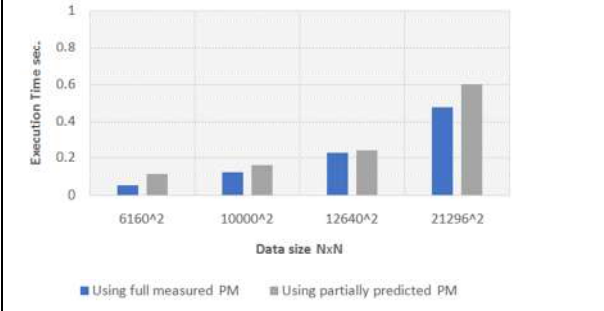
**Figure 4. Flow chart representing an ML-based approach for building a partially predicted PM.**



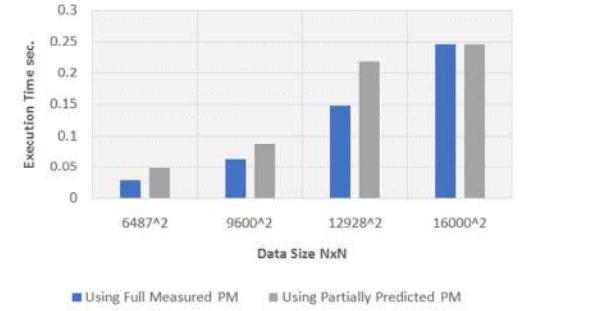
**Figure 5. Comparison of estimated execution times of matrix multiplication when distributed by the optimization algorithm based on full measured PM, and when distributed based on partially predicted PM.**



**Figure 6. Comparison of the total execution times of the Jacobi application when distributed by the optimization algorithm based on full measured PM and based on partially predicted PM.**



**Figure 7. Comparison of estimated parallel execution times of FFT when distributed based on full measured PM versus partially predicted PM.**



**Figure 8. Comparison of estimated parallel execution times of matrix multiplication when distributed based on coarse-grained full measured PM versus partially predicted PM (built based on the coarse-grained data set). Comparing to results obtained in figure 5, using fine-grained PM offers adequate information to improve the predicted results.**





## Effectiveness of Demonstration on Steam Inhalation among Rural Elderly Population

N. Gaoudam<sup>1\*</sup> and Amala Vennila.R<sup>2</sup>

<sup>1</sup>Assistant Professor, Vinayaka Mission's College of Nursing, Karaikal, Puducherry, Vinayaka Mission's Research Foundation (Deemed to be University) Salem, Tamil Nadu, India.

<sup>2</sup>Principal and Professor – Mangala College of Nursing, Hassan, Rajiv Gandhi University of Health Sciences, Bangalore, India.

Received: 01 Dec 2021

Revised: 29 Dec 2021

Accepted: 12 Jan 2022

### \*Address for Correspondence

#### N. Gaoudam

Assistant Professor,

Vinayaka Mission's College of Nursing,

Karaikal, Puducherry, Vinayaka Mission's Research Foundation (Deemed to be University)

Salem, Tamil Nadu, India.

Email: gaoudam@gmail.com



This is an Open Access Journal / article distributed under the terms of the **Creative Commons Attribution License** (CC BY-NC-ND 3.0) which permits unrestricted use, distribution, and reproduction in any medium, provided the original work is properly cited. All rights reserved.

### ABSTRACT

Inhaled treatment has a superior efficacy to safety ratio than systemic therapy because therapeutic agents are given directly to the lung. Inhaled therapy has a faster beginning of action, is easier to administer, and has a better efficacy to safety ratio than systemic therapy. To assess the efficacy of a demonstration on steam inhalation among the elderly. The research method used in this study was a quantitative evaluative technique, using a quasi-experimental one-group pre- and post-test design. Non probability purposive sampling was used to choose a total of 100 senior people. The demographic proforma and self-structured questionnaire were used to obtain the data. The split half technique was used to assess the tool's dependability, and the result was  $r=0.70$ . Pre-test and post-test knowledge scores revealed that the mean score during pre-test was  $11.53 \pm 305$  (SD), which is 38 percent of the total mean score, whereas the mean score during post-test was  $25.2 \pm 5.02$  (SD), which is 84 percent of the total mean score, indicating a 46 percent increase in mean percentage of score. The estimated 't' value of 17.52, which is larger than  $P0.05$ , indicates that the difference between the pre-test and post-test is very significant. The findings of the study revealed that a systematic training programme was extremely helpful in improving awareness about vaccination schedules among mothers of children under the age of five.

**Key words:** Asses, Effectiveness, Demonstration, Steam Inhalation, Elderly.





## INTRODUCTION

The population of people aged 60 and over is now expanding at three times the rate of the general population. Rapid advances in medicine, public health, nutrition, and sanitation have resulted in large groups of individuals living well into their senior years. The ageing population has surpassed 100 million people, with projections anticipating a high of 324 million people, or 20% of the total population, by 2050. Physical and mental health problems are more common among the elderly than in the younger population. In India, about 120 million seniors are affected by a range of medical, psychological, economic, and spiritual problems [1]. Air inhalation is a necessary aspect of the breathing cycle for all living things. It is an autonomic mechanism that does not require conscious control or effort (though there are exceptions in some illness situations) Breathing, on the other hand, may be intentionally regulated or halted (within limits). Breathing permits oxygen to enter the lungs, where it may be absorbed into the bloodstream (which humans and many other creatures require for living) [2].

Inhaling steam may have a local impact. Steam pushed into the respiratory track's deeper passageways creates a huge surface area for absorption. Gases and mists injected into the lungs are quickly absorbed by the alveolar capillary network. Airways must not obstruct regular gas exchange by restricting the bronchiole. Inhaled treatment has a superior efficacy to safety ratio than systemic therapy because therapeutic agents are given directly to the lung. Inhaled therapy has a faster beginning of action, is easier to administer, and has a better efficacy to safety ratio than systemic therapy. The most prevalent cause of human alignment is chest congestion. They are a major contributor to India's rising morbidity and death rates. Many patients who have chest congestion necessitate unexpected trips to the emergency room. Control is still a public health issue that varies not just by individual but also by socioeconomic status. Patient education, access to health care, and drug costs are all likely to have an impact on treatment outcomes [3].

## STATEMENT OF THE PROBLEM

A study to assess the Effectiveness of demonstration on steam inhalation among rural elderly population in Hassan district.

## OBJECTIVES

1. To assess the knowledge regarding steam inhalation among rural elderly population
2. To assess the Effectiveness of Demonstration on steam inhalation among rural elderly population
3. To find the Association between the knowledge regarding steam inhalation with their selected demographic variables among elderly

## MATERIAL AND METHODS

The knowledge of steam inhalation was measured using a quasi-experimental research technique in this study. The participants in this study were elderly persons from rural areas. The 60 elderly adults were chosen using the Non Probability Convenience sampling approach. Data was collected using a demographic proforma and a self-structured questionnaire. To assess knowledge of steam inhalation, the researcher devised a self-structured questionnaire with 30 multiple-choice questions. Each accurate response earns you one point, while each incorrect response earns you nothing. A score of more than 75% was deemed acceptable knowledge, 51-75% was considered moderately adequate knowledge, and less than 50% was considered inadequate knowledge. Cronbach's alpha was used to assess the tool's reliability, yielding a  $r=0.72$  result. The participants in the study have given their informed consent. Both descriptive and inferential statistics were used to analyse the data. To determine the relationship with their chosen demographic variable, descriptive analysis was done to find frequency, percentage, central tendency like mean, standard deviation, and inferential statistics like chi square.





**Gaudam and Amala Vennila**

## RESULTS AND DISCUSSION

The mean score during the pre-test was 11.53.05 (SD), which is 38 percent of the whole mean score, but the mean score during the post-test was 25.2 5.02 (SD), which is 84 percent of the total mean score, indicating a 46 percent increase in mean percentage of score. The estimated 't' value of 17.52, which is more than P0.05, shows that the difference between the pre-test and post-test is extremely significant. It showed that the demonstration was effective in increasing senior awareness of steam inhalation. As a consequence, H1 was given the green light. As a result of the Chi square test, the link between knowledge level and demographic parameters such as age in years, gender, educational level, occupation, marital status, religion, and so on was determined. Educational status and source of information were shown to have a significant (p 0.05 level) relationship, but no other characteristics were found to have a significant relationship.

This study looked at the impact of steam inhalation demonstrations on the older population. The major goal of this study was to determine how much people knew about steam inhalation. The second goal was to assess the demonstration's effectiveness in terms of steam inhalation. The researchers also wanted to see if there was a link between pre-test knowledge of steam inhalation and certain demographic characteristics. The current study's findings were backed up by Steam inhalation is a therapeutic way of bringing warm wet air into the lungs through the nose and throat. The heated steam moistens the nasal passages, raising the temperature and causing blood vessels to dilate. This improves blood circulation, allowing clogged nostrils to open and the nasal mucosa to return to its original colour. This increase in temperature causes white blood cell formation and activity to increase, resulting in increased resistance to germs and the prevention of common cold problems [4]. In our research, we discovered that patients in the study group had a much decreased complication rate.

According to a research published in the literature, steam inhalation has been shown to lessen the quantity and severity of symptoms in individuals with the common cold [5]. Theoretically, steam may assist clogged mucus be extracted more easily, and heat may kill the cold virus, as it does *In vitro*. More than 42% of respondents said they use home remedies on a regular basis in this poll. The three most often used home therapies in all categories, i.e. the preset list in the questionnaire and the open-ended questions, were hot steam inhalation, hot lemon drink, and honey. Nutritional-based home treatments were the most often mentioned type of home remedy. The most common reason for using a home remedy was to alleviate the symptoms of a cold. In our study, the majority of respondents preferred to tackle common health conditions using home remedies rather than pharmaceutical drugs. However, a study conducted in Winnipeg, Canada in 1990 with 524 patients [6] showed similar results to ours. Teas were the most widely used home remedies, followed by honey, hot lemon drink, and hot steam inhalations, according to the Winnipeg study's findings. Home remedies were used to treat common health problems such as cold symptoms, which was comparable to the findings of our study. In addition, participants in this research advocated home therapies to others.

Another study conducted in the United States in 1972 found a 30% rate of symptom management with home remedies, with bed rest, soaking, and heating pads being the most often used home treatments [7]. However, these home remedies were mentioned in only a few of the responses in our study, which might be due to a difference in cultural background, period, or research approach. The substantial discrepancy in home remedy usage between the Heidelberg and Erfurt areas might potentially be explained by a different cultural background, although we can only speculate on the true causes. The foregoing findings demonstrate the efficacy of a demonstration on steam inhalation as an adjuvant therapy in senior people suffering from a common cold. In rural regions, steam inhalation is readily available in every home, raising knowledge of the benefits of steam inhalation.





## CONCLUSION

The current findings revealed that the majority of patients lacked appropriate understanding about post-dialysis home management. The pamphlet will assist them in improving their knowledge. In order to enhance health, nurses must also build understanding about their care and control of chronic renal failure.

## REFERENCES

1. Park textbook of preventive and social medicine; k.park; bhanot publishers; 20th dition. 2009, 408-13.
2. Pitkaranta A, Hayden FG. Rhinoviruses: important respiratory pathogens. *Ann Med.* 1998; 30: 529 - 537. [2].
3. Couch RB. The common cold: control? *J Infect Dis.* 1984; 150: 167 - 173. [3]. Diehl HS. Medicinal treatment of the common cold. *JAMA* 1933; 101: 2042 - 2049. [4].
4. Bender BG, Berning S, Dudden R, Milgrom H, Tran ZV. Sedation and performance impairment of diphenhydramine and secondgeneration antihistamines: a metaanalysis. *J Allergy Clin Immunol* 2003; 111(4): 770 - 776. [5].
5. Singh M, Singhi S, Walia BN. Evaluation of steam therapy in acute lower respiratory tract infections: a pilot study. *Indian Paediatr* 1990; 27: 945 - 951.
6. Ophir D, Elad Y. Effects of steam inhalation on nasal patency and nasal symptoms in patients with the common cold. *Am J Otolaryngol* 1987; 8: 149 - 153. [14].
7. Morris S, Eccles R, Martez SJ, Riker DK, Witek TJ. An evaluation of nasal response following different treatment regimes of oxymetazoline with reference to rebound congestion. *Am J Rhinol* 1997; 11: 109 - 115. [15].
8. Hendley JO, Abbott RD, Beasley PP, Gwaltney JM Jr. Effect of inhalation of hot humidified air on experimental rhinovirus infection. *JAMA* 1994; 271: 1112 - 1123. [16]. Macknin ML, Mathew S, Medendorp SV.
9. Effect of inhaling heated vapor on symptoms of the common cold. *JAMA* 1990; 264: 989 - 991. [17]. Forstall GJ, Macknin ML, Yen-Lieberman BR, Medendorp SV. Effect of inhaling heated vapor on symptoms of the common cold. *JAMA* 1994; 271: 1109 - 1111

**Table:1 Frequency and Percentage Wise Distribution of Demographic Variables of Study Participants**

**N: 60**

S.NO.	DEMOGRAPHIC VARIABLES	FREQUENCY	PERCENTAGE (%)
1.	Age in years		
	a) 65-70 Yrs	31	52.0
	b) 71-75 Yrs	15	25.0
	c) 76 -80 Yrs	8	13.0
	d) 81-85 Yrs	6	10.0
2.	Sex		
	a. Male	48	80.0
	b. Female	12	20.0
3.	Educational level		
	a. Primary education	10	17.0
	b. Secondary education	10	17.0
	c. Higher secondary education	11	18.0
	d. Diploma/degree	5	8.0
	e. Illiterate	24	40.0
5.	Marital Status		
	a. Married	45	75.0
	b. Unmarried	10	16.0
	c. Divorce	3	6.0





**Gaudam and Amala Vennila**

	Widow/Separated	2	3.0
6.	Religion		
	a. Hindu	36	60.0
	b. Christian	14	23.0
	c. Muslim	10	17.0
7.	Source of information regarding steam inhalation		
	a. Yes	20	33.0
	b. No	40	67.0

**Table 2 :Distribution Of Participants According to Their Level of Knowledge on Steam Inhalation : 60**

Level of knowledge	Pre test		Post test	
	Frequency	Percentage (%)	Frequency	Percentage (%)
Inadequate (<50%)	42	70	10	17
Moderate (51-75%)	12	20	15	25
Adequate (>75%)	6	10	35	58

**Table-3: Comparison of Mean, SD, and mean percentage of pre-test and post- test knowledge regarding steam**

Area	Max score	Pre test scores			Post test score			Difference in mean (%)	't' test Value
		Mean	SD	Mean %	Mean	SD	Mean %		
Knowledge on Steam Inhalation	30	11.5	3.05	38	25.2	5.02	84	46	17.52* P=0.000 S

inhalation among elderly population

N=60

\*-Significant at 5% (p<0.05) level

**Table.4.Area wise comparison of pre-test and post-test levels of knowledge regarding steam inhalation**

S. No	Aspectsofkn owledge	Max. score	Before Demonstration			After Demonstration		
			Mean	SD	Mean %	Mean	SD	Mean %
1	Introduction	9	3.42	1.01	38	7.00	1.27	78
2	Purpose	10	3.70	1.20	37	8.12	1.25	81
3	Benefits of Steam inhalation	11	4.00	1.31	36	9.50	1.18	86
4	Procedure	10	3.10	1.10	31	8.26	1.03	83
5	Over all	40	14.22	4.19	38.6	32.88	4.08	82.2

**Table.4.Association between pre-test levels of knowledge regarding steam inhalation among elderly with their selected demographic variables**

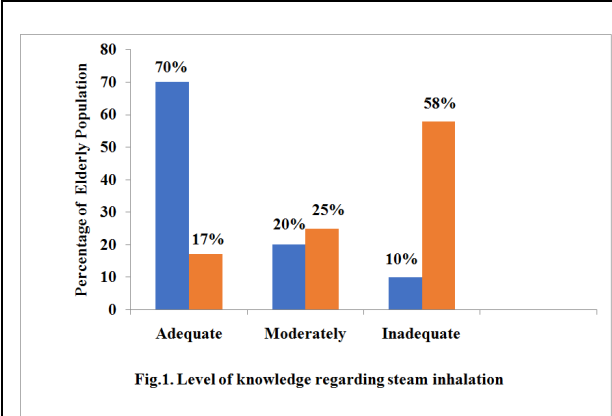
S.NO.	DEMOGRAPHIC VARIABLES	X <sup>2</sup> Value	P- value	LEVELOF SIGNIFICANCE
1.	Education	13.088	0.010*	<b>SIGNIFICANT</b>
2.	Source of information	15.423	0.003*	<b>SIGNIFICANT</b>

\*Significant at 5% p < 0.05 level

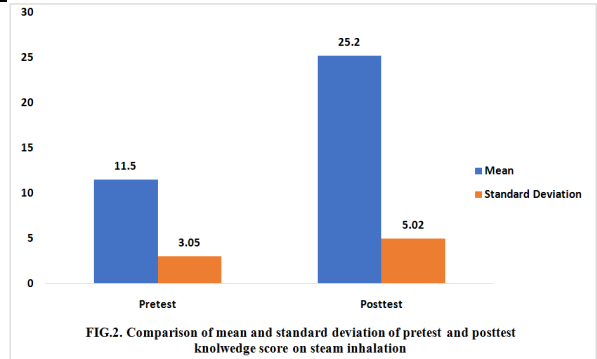




**Gaoudam and Amala Vennila**



**Fig.1. Level of knowledge regarding steam inhalation**



**Fig.2. Comparison of mean and standard deviation of pretest and posttest knowledge score on steam inhalation**





## Study of Antibacterial and Antioxidant Potential of *Prunella vulgaris* L. Flower Extract- A Medicinally Active Herb Grown in Kashmir

Khursheed Ahmad Dar<sup>1\*</sup> and S.Senthilmurugan<sup>2</sup>

<sup>1</sup>Ph.D Research Scholar, Department of Zoology, Annamalai University, Annamalai Nagar, Tamil Nadu, India.

<sup>2</sup>Associate Professor, Department of Zoology, Annamalai University, Annamalai Nagar, Tamil Nadu, India.

Received: 16 Nov 2021

Revised: 21 Dec 2021

Accepted: 10 Jan 2022

### \*Address for Correspondence

**Khursheed Ahmad Dar**

Ph.D Research Scholar,

Department of Zoology,

Annamalai University, Annamalai Nagar,

Tamil Nadu, India.

Email: khursheedzoology19@gmail.com



This is an Open Access Journal / article distributed under the terms of the **Creative Commons Attribution License** (CC BY-NC-ND 3.0) which permits unrestricted use, distribution, and reproduction in any medium, provided the original work is properly cited. All rights reserved.

### ABSTRACT

The flower of *Prunella vulgaris* (Lamiaceae) was investigated for its in-vitro anti-oxidant and anti-bacterial activity. The antioxidant activity revealed that the methanol extract of *Prunella vulgaris* flower (MEFE) possess highest scavenging capacity than petroleum ether extract (petroleum ether = PEFE). The antimicrobial activity showed that *Staphylococcus aureus*, *Klebsiella pneumonia* and *Escherichia coli* were the most susceptible pathogens and significant activity was also recorded by PEFE against *Staphylococcus aureus*, *S. pneumonia*, *Enterococcus faecalis* and *K. pneumonia* strains tested, at different concentrations. Column chromatographic fractions were also tested for antibacterial activity, wherein F2 (fraction 2) out of six fractions showed appreciable antibiotic activity against all the organisms tested. FT-IR analysis was done to confirm functional groups and nutrient type present. Besides the plant has great importance as far as its other clinical applications are concerned. The present investigation can be used for comparative evaluation of bioactive constituents with other species of medicinal plants present in different parts of the world and can be used for preparation of superior combination of this herb to use in pharmaceutical industries.

**Keywords:** *Prunella vulgaris*; *Staphylococcus aureus*; *Klebsiella pneumonia*; *Escherichia coli*



**Khursheed Ahmad Dar and Senthilmurugan**

## INTRODUCTION

"*Prunella*" a genus of lamiaceae family, approximately there are 15 species of *Prunella* distributed worldwide in the temperate regions and tropical mountains of Europe and Asia (1). In the genus *prunella*, *Prunella vulgaris* L. consists of long stem (1-2 feet) having leaves notched on the edge. At the top of the stem the flowers with purple colour are present which bloom mostly from June to August. *Prunella vulgaris* L. is known to have some medical importance. *P. vulgaris* is semi-wild and is found in open, humid regions like banks of streams, farming land and under the shade of shrubbery. This plant was popular in European traditional medicine during the 17th century as a remedy for sore throat, fever and accelerating wound healing [2]. In Kashmir, *P. vulgaris* is called as "Kalleh- yeuth" and is used in Unani medicine. In chilly winters it is used as brain tonic, as it is boiled and inhaled in the form of steam which clears viscid mucus from throat and reduces headache. In Kashmir the herb is used as one of the composite traditional medicine for bathing women after giving birth to the baby. It was introduced in folk medicine as a traditional antipyretic remedy in China [3]. Phyto-chemical investigation has revealed that *P. vulgaris* contains phenols, saponins, alkaloids, tannins, terpenes and anionic polysaccharide prunellin [4]. Prunellin shows anti-HIV activity [5], anti-ulcer activity [28] and it also exhibits anti-*Herpes simplex* virus type 1 and 2 activity. Aqueous and ethanol extracts of *P. vulgaris* also revealed to exhibit the scavenger effects on DPPH [6]. The antimicrobial activity of *P. vulgaris* methanol extract against *Staphylococcus aureus* and *Enterococcus faecalis* has also been confirmed [7]. In addition to the pharmaceutical uses of *P. vulgaris*, its air-dried parts are used in a refrigerated beverage, and the fresh leaves are prepared in a vegetable dish in southeast China [8]. The plant is perennial herb which is wild in Kashmir valley and is widely used. To the best of our knowledge, Kashmir grown *Prunella vulgaris* flower methanol and petroleum ether extracts have not been previously studied separately for anti-bacterial and anti-oxidant activities.

## MATERIALS AND METHODS

### Collection and preparation of plant extracts

*Prunella vulgaris* was collected during the month of August 2020 from the Aharbal area of Jammu and Kashmir. The *P. vulgaris* species was identified and authenticated by Dr. S. Ramesh Kumar, Professor of Horticulture, faculty of Agriculture Annamalai University (India) with specimen no. Hort./Id.2/2020. The plant was first subjected for surface sterilization by using 70% ethyl alcohol for 3 minutes followed by 0.5% NaOCl for 5 minutes and then rinsed. The flowers were separated from the plant and dried in the shade for 9 days [27]. The dried plant material was ground by electric grinder. The ground powder was extracted with different solvents (Methanol and Petroleum ether) using soxhlet extractor.

### Antioxidant assays

#### ABTS radical scavenging assay

This method measures the potential of different compounds to scavenge the 2,2- azino-bis-3-ethylbenzothiazoline-6-sulphonic acid radical cation (ABTS) [9]. The antioxidant activity was measured in a reaction mixture containing 0.5 mL of 15  $\mu$ M H<sub>2</sub>O<sub>2</sub>, 0.5ML of 7 mM ABTS, and 50Mm sodium phosphate buffer, pH 7.5. The absorbance were recorded by spectrophotometer at 734 nm and then compared with standard ascorbic acid. IC<sub>50</sub> value is the concentration of sample required to inhibit 50% of ABTS production. The percentage inhibition of ABTS was calculated as the following equation:

$$\% \text{ of [ABTS] scavenging} = \frac{A_0 - A_1}{A_0} \times 100$$

Where A<sub>0</sub> was the absorbance of the control and A<sub>1</sub> was the absorbance in the presence of the sample of ascorbic acid (ABA).

#### DPPH free radical scavenging assay



**Khursheed Ahmad Dar and Senthilmurugan**

The free radical scavenging capacity of methanol and petroleum ether extracts of *P. vulgaris* against DPPH (2, 2-diphenyl-1-picrylhydrazyl) was determined spectrophotometrically by the method of (10). DPPH is considered as a stable free radical and upon reduction becomes stable diamagnetic molecule. DPPH donates hydrogen after reacting with an antioxidant and gets reduced, the change in colour from deep violet to light yellow was measured which is directly proportional to the amount and nature of radical scavenger present. Previous results also revealed that the ethanol and water extraction had very strong anti-oxidative activity wherein DPPH, FRAP, ABTS, SOD and the generation of ROS methods were used to evaluate the anti-oxidant activities of different solvent extraction fractions (70% ethanol, hexane, n-butanol, chloroform and water) of *P. vulgaris* var. *lilacina*; the results showed [21].

**Antimicrobial studies****Microorganisms and culture maintenance**

Antimicrobial activity of *P. vulgaris* flower extract was done against three gram positive and two gram negative pathogenic bacterial strains. Certified pathogenic microbial strains i.e. *Staphylococcus aureus*, *Streptococcus pneumonia*, *Enterococcus faecalis*, *Klebsiella pneumonia* and *Escherchia coli*, were obtained from Department of Microbiology Annamalai University, India. Various media viz. Muller-Hinton agar and nutrient agar were used for the maintenance of stock cultures. Bacterial strains were grown on agar media at 37°C until visible colonies appeared on the agar slants typically for 24 h. The colonies of different microbial strains were harvested in Muller Hinton Broth (MHB) and grown until late log phase.

**Well diffusion assay.**

The culture was then used as inocula for culturing pathogenic strains of bacteria on petri-dishes; one strain per plate, for the antimicrobial activity using the agar diffusion method. The wells were made on the plates with a sterile cork borer of 4 mm diameter for the different extracts and the plates were incubated at 37°C for 24 h and zones of inhibition were observed. 75, 100, 125 and 150 µg (diluted with mg/mL) of the extracts were impregnated in the wells (4mm). Chloramphenicol (15µl/well) was taken as positive control and DMSO as the negative control for bacterial strains [26].

**Column chromatography**

The MEFE crude extract obtained after soxhlet extraction was subjected to column chromatography. The bioactive secondary metabolites were chromatographically separated with a normal phase packed silica gel column (column chromatography) by the method followed by [18] with little modifications. The packed silica column was prepared using 12.5 g of silica gel. The dried MEFE was solubilised in DMSO. Then, 0.5 g of silica was added, and allowed to dry so as to make a dry band, and then added to the top of the packed silica column. Then the column was eluted with different solvents. A total of seven fractions were collected, each fraction containing 15 ml. The similarity of the collected fractions was checked using thin-layer chromatography (TLC) plates with ethyl acetate and hexane as the solvents. The collected fractions were screened for antimicrobial activity using the well diffusion method.

**Phytochemical investigation****Total phenolic content (TPC)**

TPC of PEFE, and MEFE were determined based on Folin-Ciocalteu (FC) method followed by [12] with minor modifications. 500 µL of sample extracts was mixed with 2.5 mL of FC reagent (10 times pre-diluted) and were allowed to settle for 5 min. consequently 1.8 mL of (8 % w/v) sodium carbonate solution were supplemented and mixed thoroughly. Absorbance was measured at 750 nm by using UV-VIS spectrophotometer (Shimadzu UV-Visible 160A, Kyoto Japan), after the incubation of 1 h at room temperature. Gallic acid has been used as standard. Total content of phenolics were expressed as mg gallic acid equivalents (GAE) per gram of sample.

**Total flavonoids content (TFC)**

**Khursheed Ahmad Dar and Senthilmurugan**

TFC of PEFE and MEFE were determined using the aluminium chloride method as described in [11] with slight modifications. In brief 500 $\mu$ L of 2% ALCL<sub>3</sub> (aluminium chloride) with methanol were added to 500  $\mu$ L of sample extract. Absorbances were recorded at 430 nm using a UV-visible spectrophotometer (Shimadzu UV-Visible 160A, Kyoto Japan) after the incubation of 15 minutes at room temperature. Quercetin has been used as standard. Total content of flavonoids were expressed as mg quercetin equivalents per gram of the dry weight of sample. The values were presented as means of triplicate analysis.

**Fourier Transform Infrared (FT-IR) Spectroscopy Analysis**

FT-IR spectra were obtained by using FTIR Spectrophotometer (Agilent technologies, Cary 630 FT-IR). All spectra were recorded from 4000-500  $\text{cm}^{-1}$  region, outfitted with a KBr beam splitter, nicrome source and DTGS detector with a data acquisition rate of 2  $\text{cm}^{-1}$ .

**Statistical analysis**

All the examinations were executed in triplicate, and the values were expressed as the mean  $\pm$  standard deviation. The results were evaluated through analysis of variance (ANOVA) with Duncan's multiple range tests ( $p < 0.05$ ) using SPSS

**RESULTS AND DISCUSSION**

Evaluation of the antioxidant activities of two flower extracts of *Prunella vulgaris*, DPPH and ABTS assays were analyzed as shown in Table 1. The DPPH and ABTS assays are based on electron transfer between sample and the reagent radical and are measured by means of their colour changes spectrophotometrically. Both the extracts of *Prunella vulgaris* revealed significant free radical scavenging activity against DPPH and ABTS assay, in comparison of high antioxidant effect of ascorbic acid. However, MEFE showed the highest antioxidant activity at a sample concentration of 100  $\mu$ L with IC<sub>50</sub> value of  $19.43 \pm 5.21 \mu\text{g/ml}$  for DPPH and  $22.22 \pm 0.34 \mu\text{g/ml}$  for ABTS. While PEFE showed the highest antioxidant activity at a sample concentration of 100  $\mu$ L having IC<sub>50</sub> value of  $33.59 \pm 1.14 \mu\text{g/ml}$  for DPPH and  $59.34 \pm 0.32 \mu\text{g/ml}$  for ABTS. The free radical scavenging activity of different extracts of *Prunella vulgaris* are comparable with previous reported studies on flower and whole plant extracts [12, 13]. The evaluation of TPC was done by using Folin-Ciocalteu method, are shown (Table 1) to support the antioxidant activity of flower extract of *Prunella vulgaris*. MEFE showed the higher TPC ( $117.31 \pm 4.10 \text{ mg/g DM}$ ) in comparison to that of PEFE ( $79.12 \pm 5.54 \text{ mg/g DM}$ ), which shows similarity to that of previously reported TPC ( $115.7 \text{ mg GAC/g}$ ) of *Prunella vulgaris* methanol extracts [14]. Phenolics were also reported to exhibit antioxidant activity, anticancer effects, and various other biological functions and may prevent the development of aging and disease [23]. Studies also revealed that poly-phenolic compounds exhibit a gastro-protective effect by increasing the production of mucus, by suppressing the activity of neutrophils and pro-inflammatory cytokines [29, 30].

Flavonoids are the secondary metabolites having several health advantages such as antioxidant, anti-inflammatory and anti-microbial activities [15]. MEFE showed highest TFC ( $84.12 \pm 5.35 \text{ mg/g DM}$ ) values, compared to PEFE ( $79.12 \pm 5.54 \text{ mg/g DM}$ ) which is significant than previously reported methanol extract of whole plant of *Prunella vulgaris* where TFC was  $82.8 \text{ mg QE/g}$  [15].

**Antimicrobial activity**

The antimicrobial potential of flower extract of *Prunella vulgaris* against three gram positive and two gram negative bacteria were evaluated by using well diffusion method and results are presented in Table 4. The results revealed that the flower of *Prunella vulgaris* showed significant antimicrobial activity against all the bacterial strains tested. Gram positive bacteria were more susceptible than gram negative bacteria and the zones of inhibition were dependent on the concentrations of the sample taken. The MEFE showed highest antimicrobial activity with the highest zone of inhibition values of 21 mm, 17 mm, 15 mm and 12 mm at different concentrations (150  $\mu$ l, 125  $\mu$ l, 100  $\mu$ l and 75  $\mu$ l respectively) against *staphylococcus aureus* and the lowest zones of inhibition values of 14 mm, 12 mm, 11





**Khursheed Ahmad Dar and Senthilmurugan**

mm and 8 mm at different sample concentrations (150  $\mu$ l, 125  $\mu$ l, 100  $\mu$ l and 75  $\mu$ l respectively) against *Enterococcus faecalis* (Fig. 1). The PEFE showed highest activity against *S. pneumonia* (17 mm zone of inhibition at 150  $\mu$ l) and lowest against *E. faecalis* (Fig. 2) (12 mm zone of inhibition at 150  $\mu$ l). Methanolic extracts of *P.vulgaris* was found to be highly effective against *K. pneumonia* [32]. Yoon et al. has recently found that the methanol extract of *P. vulgaris* possess an efficient anti-fungal and anti-oomycete activity on *Phytophthora infestans*, rice blast fungus, red pepper anthracnose and wheat leaf rust fungus [16]. Mahboubi et al. revealed that the methanol extract of *P. vulgaris* showed the best activity against *St. mutans* (MIC 3.2 mg.7ml), *S. aureus*, *S. epidermidis*, *S. sobrinus*, *S. sanguis*, *S. salivarius*, *S. dysenteriae*, *S. flexeneri*, *P. aeruginosa* (MIC 3.2, 6.4 mg/ml). *S. saprophyticus*, *S. pneumoiae*, *S. pyogenes*, *E. faecalis*, *E. faecium*, *S. agalactiae*, *K. pneumoniae*, *E. aerogenes*, *A. flavus*, *A. niger* and *S. marcescenes* having MIC and MLC 6.4 and 12.8 mg/g exhibited lower sensitivity to methanol extract [17]. *S.pyogenes* and *C.albicans* were also reported to have higher susceptibility against *P. vulgaris* methanol extract [25]. Several researchers have shown that the extracts of *Prunella vulgaris* exhibited significant anti-microbial activity. Rosmarinic acid of *P. vulgaris* was found to show moderate antibacterial activity on gram positive bacteria [22] and highly effective against gram negative bacterial strains [24]. Aqueous and ethanolic extracts of *P. vulgaris* have a positive effect against multi drug resistant *E. coli* strain isolated from patients with urinary tract infections [31]. Our results revealed that the MEFE extracts exhibited significant antibacterial activity than PEFE extracts, probably different subspecies and/or the geographical origin of the plants tested.

Preliminary identification of antibacterial activity of crude extract of MEFE, DMSO soluble fraction was subjected to column chromatography on silica gel using n-hexane and ethyl acetate as a solvent with gradual increasing in polarity up to 100% ethyl acetate [18], which resulted in six fractions (Fractions 1–6), the column fractions were screened, with second fraction (F<sub>2</sub> light green in colour) showing a broad-spectrum antibacterial activity against all the strains tested (Table 4, Fig. 3).

**FT-IR spectral analysis**

FT-IR spectra and functional group of compounds present in *Prunella vulgaris* methanol and petroleum ether extract are shown in figure (1) and (2) respectively. Spectral analysis of methanol and petroleum ether extracts revealed almost identical functional groups. Spectral data confirmed the presence of bioactive functional groups like alkanes (C–H stretching, C–H rock), alkenes (–C=C– stretching, =C–H bending), alkynes (–C≡C–H: C–H stretching), 1°, 2° amines and amides (N–H stretching),  $\alpha$ ,  $\beta$ -unsaturated aldehydes and ketones (C=O stretching), 1° amines (N–H bending), aromatic (=C–C in-ring), aliphatic amines (C–N stretching), alkyl halides (C–Cl stretching) [20]. IR absorption frequencies and the representative spectra are shown in Table.2 and Fig.3. However, when it comes to mixtures of many different compounds, it is premature to mention here that results obtained in FT-IR alone are sufficient to prove the existence of compound classes.

**CONCLUSION**

Results revealed from the study showed that MEFE and PEFE of *Prunella vulgaris* possess significant antioxidant and antimicrobial activity, hence is an efficient easily accessible source of natural bioactive compounds. However, susceptibility against the pathogens was found to be more in MEFE as compared to PEFE and radical scavenging activity was also observed to be high in MEFE than that of PEFE. Our results were more significant than previously reported studies [12]. Thus, the present study explored the fact that the flower extract of *Prunella vulgaris* possess a great reservoir of new antioxidants and antimicrobial agents. The study also explored that *Prunella vulgaris* is a potential source of bioactive compounds that can be utilized as functional food supplements, and need to be explored in more details. It may be an appropriate natural source for drugs that can be used for the treatment of infections to prevent many diseases. Therefore, the fractions showing good purity on TLC and high antimicrobial activity were selected for further experimentation to isolate the anti-bacterial and antioxidant compounds from MEFE using different spectroscopic techniques.



**Khursheed Ahmad Dar and Senthilmurugan****ACKNOWLEDGEMENTS**

The authors acknowledge the Department of Zoology and Department of Microbiology, Annamalai University for providing necessary facilities.

**Conflict of Interest**

The authors have no conflict of interest.

**REFERENCES**

1. Bai, Y., Xia, B., Xie, W., Zhou, Y., Xie, J., Li, H., ... & Li, C. (2016). Phytochemistry and pharmacological activities of the genus *Prunella*. *Food chemistry*, 204, 483-496.
2. Psotová, J., Kolář, M., Soušek, J., Švagera, Z., Vičar, J., & Ulrichová, J. (2003). Biological activities of *Prunella vulgaris* extract. *Phytotherapy Research: An International Journal Devoted to Pharmacological and Toxicological Evaluation of Natural Product Derivatives*, 17(9), 1082-1087.
3. Markov, H., Sousek, J., & Ulrichov, J. (1997). *Prunella vulgaris* L.-a rediscovered medicinal plant. *Ceska Slov Farm*, 46(2), 58-63.
4. Rasool, R., Ganai, B. A., Akbar, S., Kamili, A. N., & Masood, A. (2010). Phytochemical screening of *Prunella vulgaris* L.-an important medicinal plant of Kashmir. *Pak. J. Pharm. Sci*, 23(4), 399-402.
5. Lam, T. L., Lam, M. L., Au, T. K., Ip, D. T. M., Ng, T. B., Fong, W. P., & Wan, D. C. C. (2000). A comparison of human immunodeficiency virus type-1 protease inhibition activities by the aqueous and methanol extracts of Chinese medicinal herbs. *Life sciences*, 67(23), 2889-2896.
6. Xu, H. X., Lee, S. H., Lee, S. F., White, R. L., & Blay, J. (1999). Isolation and characterization of an anti-HSV polysaccharide from *Prunella vulgaris*. *Antiviral research*, 44(1), 43-54.
7. Chen, Y.H., Zhu, Z.B., Guo, Q.S., Zhang, L.X. and Zhang, X.M. (2012). Variation in concentrations of major bioactive compounds in *Prunella vulgaris* L. related to plant parts and phenological stages. *Biol. Res.* 45:181-185
8. Psotova J, Kolar M, Sousek J, Svagera Z, Vicar J, Ulrichova J. *Biological activities of Prunella vulgaris* extract. *Phytother Res* 2003; 17(9):1082-108
9. Arnao, M. B.; Cano, A.; Acosta, M. The Hydrophilic and Lipophilic Contribution to the Total Antioxidant Activity. *Food Chem* 2001, 73, 239–244. DOI: 10.1016/S0308-8146(00)00324-1
10. Orhan, I.; Aslan, M. Appraisal of Scopolamine-Induced Anti-Amnesic Effect in Mice and in Vitro Antiacetylcholinesterase and Antioxidant Activities of Some Traditionally Used Lamiaceae Plants. *J Ethnopharmacol.* 2009, 122, 327–332. DOI: 10.1016/j.jep.2008.12.026.
11. Lamaison, J. L.; Carnat, A.; Petitjean-Freytet, C. Main Flavonoid Contents of Commercial Samples of *Filipendula Ulmaria* (L.). *Maxim. Plant. Med. Phytother* 1991, 25, 1–5.
12. Rasool, R., Ganai, B. A., Kamili, A. N., Akbar, S., & Masood, A. (2010). Antioxidant and antibacterial activities of extracts from wild and in vitro-raised cultures of *Prunella vulgaris* L. *Medicinal and Aromatic Plant Science and Biotechnology*, 4(1), 20-27.
13. Seo, J. K., Kang, M. J., Shin, J. H., Lee, S. J., Jeong, H. G., Sung, N. J., & Chung, Y. C. (2010). Antibacterial and antioxidant activities of solvent extracts from different parts of Hagocho (*Prunella vulgaris*). *Journal of the Korean Society of Food Science and Nutrition*, 39(10), 1425-1432.
14. Mahboubi, M., Mahboubi, A., & Kazempour, N. (2015). The antimicrobial activity of *Prunella vulgaris* extracts. *Herba polonica*, 61(1).
15. Kumar, S.; Pandey, A. K. Chemistry and Biological Activities of Flavonoids: An Overview. *Scientific World Journal* 2013, Article ID 162750, 16. DOI: 10.1155/2013/162750.




**Khurshed Ahmad Dar and Senthilmurugan**

16. Yoon, M. Y., Choi, G. J., Choi, Y. H., Jang, K. S., Park, M. S., Cha, B., & Kim, J. C. (2010). Effect of polyacetylenic acids from *Prunella vulgaris* on various plant pathogens. *Letters in Applied Microbiology*, 51(5), 511-517.
17. Mahboubi, M., Mahboubi, A., & Kazempour, N. (2015). The antimicrobial activity of *Prunella vulgaris* extracts. *Herba polonica*, 61(1).
18. Sebak, M., Saafan, A. E., Abdelghani, S., Bakeer, W., Moawad, A. S., & El Gendy, A. O. (2021). Isolation and optimized production of putative antimicrobial compounds from Egyptian soil isolate *Streptomyces* sp. MS. 10. *Beni-Suef University Journal of Basic and Applied Sciences*, 10(1), 1-12.
19. Sarwar, R., Farooq, U., Naz, S., Riaz, N., Majid Bukhari, S., Rauf, A., & Al-Showiman, S. S. (2018). Isolation and characterization of two new antimicrobial acids from *Quercus incana* (Bluejack Oak). *BioMed research international*, 2018.
20. Nandiyanto, A. B. D., Oktiani, R., & Ragadhita, R. (2019). How to read and interpret FTIR spectroscopy of organic material. *Indonesian Journal of Science and Technology*, 4(1), 97-118.
21. Hwang, Y. J., Lee, E. J., Kim, H. R., & Hwang, K. A. (2013). In vitro antioxidant and anticancer effects of solvent fractions from *Prunella vulgaris* var. lilacina. *BMC complementary and alternative medicine*, 13(1), 1-9.
22. Psotová, J., Kolář, M., Soušek, J., Švagera, Z., Vičar, J., & Ulrichová, J. (2003). Biological activities of *Prunella vulgaris* extract. *Phytotherapy Research: An International Journal Devoted to Pharmacological and Toxicological Evaluation of Natural Product Derivatives*, 17(9), 1082-1087.
23. Wu, X., Beecher, G. R., Holden, J. M., Haytowitz, D. B., Gebhardt, S. E., & Prior, R. L. (2006). Concentrations of anthocyanins in common foods in the United States and estimation of normal consumption. *Journal of agricultural and food chemistry*, 54(11), 4069-4075.
24. Askun, T., Tumen, G., Satil, F., & Ates, M. (2009). Characterization of the phenolic composition and antimicrobial activities of Turkish medicinal plants. *Pharmaceutical Biology*, 47(7), 563-571
25. Saltan, N., KIRICI, D., Köse, Y. B., & Demirci, B. (2018). Chemical compositions and antimicrobial activity of *Prunella vulgaris* L. *International Journal of Agriculture Environment and Food Sciences*, 2(Special 1), 186-189.
26. Kalyoncu, F., & Oskay, M. (2008). Antimicrobial activities of four wild mushroom species collected from Turkey. In *Mushroom biology and mushroom products. Proceedings of the Sixth International Conference on Mushroom Biology and Mushroom Products, Bonn, Germany, 29 September-3 October, 2008* (pp. 31-35). GAMU GmbH, Institut für Pilzforschung.
27. Çetin B, Kalyoncu F, Özen TE. Antimicrobial potential of *Taraxacum officinale* F.H. Wigg clonally propagated via organogenesis. *Int J Green Herbal Chem*. 2018; 7:224-230
28. GROȘAN, A., ȘTEFĂNESCU, R., Gurzu, S., Muntean, D. L., Vlase, L., & Vari, C. E. (2020). Study of the potential antiulcerous action of hydroalcoholic extracts from *Prunella vulgaris* L. of Romanian origin. *Farmacia*, 68(5), 870-881.
29. Rahbardar, M. G., Amin, B., Mehri, S., Mirnajafi-Zadeh, S. J., & Hosseinzadeh, H. (2017). Anti-inflammatory effects of ethanolic extract of *Rosmarinus officinalis* L. and rosmarinic acid in a rat model of neuropathic pain. *Biomedicine & Pharmacotherapy*, 86, 441-449.
30. Rocha, J., Eduardo-Figueira, M., Barateiro, A., Fernandes, A., Brites, D., Bronze, R., & Sepodes, B. (2015). Anti-inflammatory effect of rosmarinic acid and an extract of *Rosmarinus officinalis* in rat models of local and systemic inflammation. *Basic & clinical pharmacology & toxicology*, 116(5), 398-413.
31. Komal, S., Kazmi, S. A. J., Khan, J. A., & Gilani, M. M. (2018). Antimicrobial activity of *Prunella Vulgaris* extracts against multi-drug resistant *Escherichia Coli* from patients of urinary tract infection. *Pakistan journal of medical sciences*, 34(3), 616.
32. Turker, A. U., Yildirim, A. B., Tas, I., Ozkan, E., & Turker, H. (2021). chemical profile, antibacterial and antioxidant potentials. *Biotechnol Lett*, 26(2), 2499-2510.





### Khursheed Ahmad Dar and Senthilmurugan

**Table 1. DPPH and ABTS radical scavenging activities of MEFE and PEFE extracts**

Extract	DPPH and ABTS Antioxidant activity as IC <sub>50</sub> (µg/ml)						Contents in mg/g DM	
	100 µg/ml		200 µg/ml		300 µg/ml		TFC	TPC
	DPPH	ABTS	DPPH	ABTS	DPPH	ABTS		
MEFE	19.43 ± 5.21	22.22 ± 0.34	32.40 ± 2.78	27.65 ± 0.45	43.35 ± 3.12	49.97 ± 1.32	84.12 ± 5.35	117.31 ± 4.10
PEFE	33.59 ± 1.14	59.34 ± 0.32	66.42 ± 2.68	75.13 ± 1.77	83.60 ± 3.83	95.43 ± 2.17	79.12 ± 5.54	84.35 ± 6.65
ABA	45.63 ± 1.1	45.63 ± 1.10	47.18 ± 1.56	47.18 ± 1.56	49.10 ± 0.51	49.10 ± 0.51	-	-

DPPH radical scavenging activities; ABTS radical scavenging activities and Total flavonoid contents (TFC) and Total phenolic contents (TPC) of *P. vulgaris* L. flower extracts.

**Table 2. Zones of inhibition (mm) of flower extract of *Prunella vulgaris* L.**

Extract	Bacterial strains	Sample concentration (µl/ml)					
		75	100	125	150	Pc	Nc
MEFE	<i>S. aureus</i>	12	15	17	21	30	ND
	<i>E. faecalis</i>	9	11	13	15	17	ND
	<i>S. pneumonia</i>	8	12	15	18	20	ND
	<i>K. pneumonia</i>	13	15	16	19	30	ND
	<i>E. coli</i>	8	11	12	14	32	ND
PEFE	<i>S. aureus</i>	9	10	10	15	21	ND
	<i>E. faecalis</i>	7	10	10	12	31	ND
	<i>S. pneumonia</i>	7	11	14	17	25	ND
	<i>K. pneumonia</i>	12	13	15	17	32	ND
	<i>E. coli</i>	8	10	11	13	27	ND

Data represents mean of 3 replicates; positive control (Pc) is Chloramphenicol; Negative control (Nc) is DMSO.

**Table 3. Zones of inhibition of F2 of MEFE.**

Extract	Bacterial strains	Sample concentration (µl/ml)					
		75	100	125	150	Pc	Nc
MEFE	<i>S. aureus</i>	7	9	11	15	23	ND
	<i>E. faecalis</i>	7	9	13	15	25	ND
	<i>K. pneumonia</i>	10	11	15	17	33	ND
	<i>E. coli</i>	6	8	12	14	35	ND

Data represents mean of 3 replicates; positive control (Pc) is Chloramphenicol; Negative control (Nc) is DMSO

**Table 4. Major bands observed in the FT-IR spectra of MEFE and PEFE.**

S. No	Major bonds				Possible nutrient	Phytochemicals
	IR ν <sub>max</sub> (cm <sup>-1</sup> ) (Vibration mode)			Functional groups		
	Frequency (m <sup>-1</sup> )	Bond				
1	670-780	C-H rock, C-Cl stretch, C-H oop, N-H wag	Alkanes, alkyl halides, aromatics, 1°, 2° amines	carbon	Alkaloids, flavonoids,	
2	810-880	C-Cl stretch, C-H oop,	alkyl halides, aromatics, 1°, 2° amines, alkenes	carbon	tannins,	





**Khursheed Ahmad Dar and Senthilmurugan**

		N-H wag, =C-H bend			poly phenols and carboxylic acid containing phytochemicals
3	1030-1090	C-H wag(-CH2X), C-O stretch, C-N stretch	alkyl halides, alcohols, carboxylic acids, esters, ethers, aromatic amines	carbohydrate	
4	1110-1165	C-H wag(-CH2X), C-O stretch, C-N stretch	alkyl halides, alcohols, carboxylic acids, esters, ethers, aromatic amines	protein	
5	1245-1260	C-N stretch, C-H wag (-CH2X), C-O stretch	aromatic amines, alkyl halides, alcohols, carboxylic acids, esters, ethers,	protein	
6	1375-1396	C-H bend	Alkanes	Protein and collagen	
7	1435-1460	C-H bend, = C-C stretch (in-ring)	Alkanes, aromatics	Protein and collagen	
8	1520-1595	N-H bend	1° amines	protein	
9	1680-1685	N-H bend, -C=C- stretch	1° amines, alkenes	protein	
10	1705-1710	C=O stretch,	α, β-unsaturated aldehydes, ketones	fat	
11	2109-2110	C≡C stretch	Alkyne	Amino related component	
12	2340-2345	NH stretch	Amino related component	Amino related component	
13	2850-2855	C-H stretch, O-H stretch	Alkanes, carboxylic acids	Carbon	
14	2919-2925	C-H stretch, O-H stretch	Alkanes, carboxylic acids	Carbon	
15	3244-3280	N-H stretch, O-H stretch (H-bonded)	1°, 2° amines, amides, alcohols, phenols	water	
16	3500-3505	O-H stretching	Hydrogen bonding typical	water	

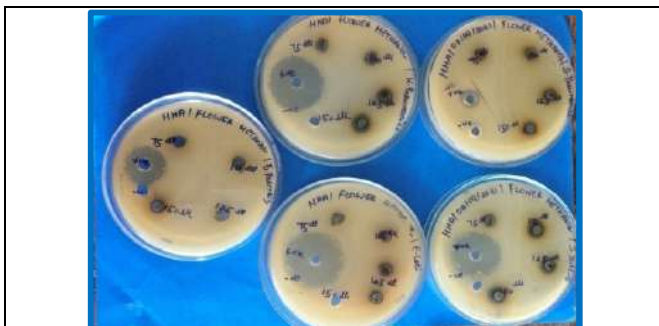


Figure 1. zones of inhibition of MEFE against *E.faecalis*, *S.pneumonia*, *K.pneumonia*, *S. aureus* and *E.coli*.



Figure 2. zones of inhibition of PEFE against *E.faecalis*, *S.pneumonia*, *K.pneumonia*, *S. aureus* and *E.coli*.



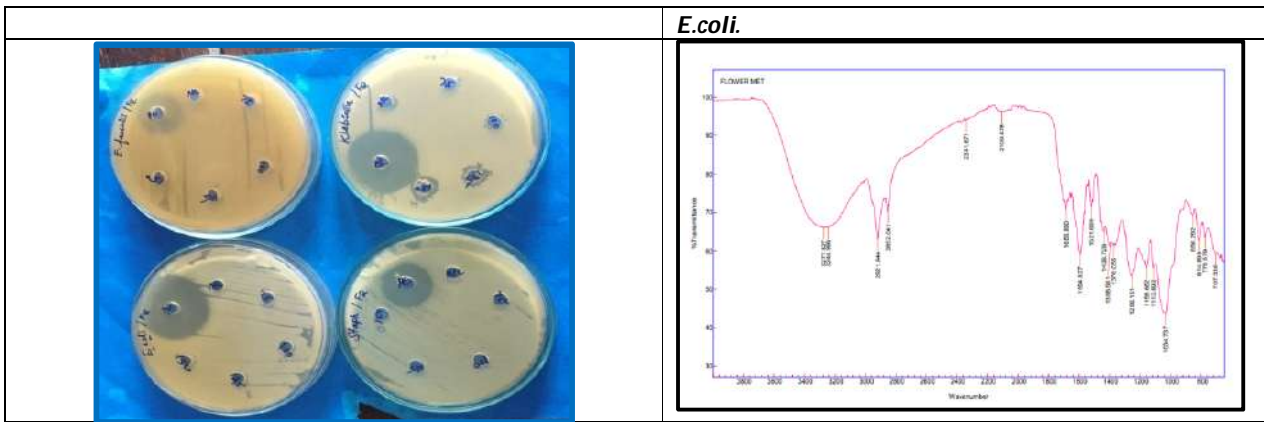


Figure 3.. zones of inhibition of F2 against *E.faecalis*, *K.pneumonia*, *S. aureus* and *E.coli*.

Figure 4. FT-IR spectrum of MEFE

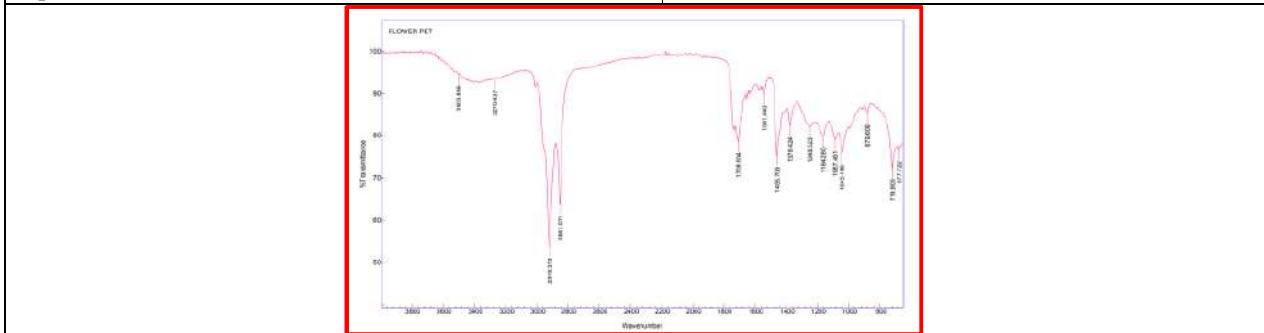


Figure 5. FT-IR spectrum of PEFE





## Nature and Distribution of Laticifers in the Bark of Juvenile Seedling of *Hevea brasiliensis*

Philipose Omman\*

Associate Professor, Department of Botany, Catholicate College, Pathanamthitta – 689 645, Kerala, India.

Received: 30 Oct 2021

Revised: 15 Nov 2021

Accepted: 07 Jan 2022

### \*Address for Correspondence

#### Philipose Omman

Associate Professor,  
Department of Botany,  
Catholicate College,  
Pathanamthitta – 689 645,  
Kerala, India  
Email: philiposeomman@catholicatecollege.ac.in



This is an Open Access Journal / article distributed under the terms of the **Creative Commons Attribution License** (CC BY-NC-ND 3.0) which permits unrestricted use, distribution, and reproduction in any medium, provided the original work is properly cited. All rights reserved.

### ABSTRACT

Laticifers in *Hevea brasiliensis* is one of the important specialized tissue systems which is significant due to the presence of latex in this tissue. The present investigation was carried out to understand the nature of laticifers and the formation of a network in the immature bark. Hybrid seedling progenies of Wickham x Brazilian were selected for the study. During the development of secondary phloem, the laticifers were originated from the phloem derivatives as rows and they formed typical articulated anastomosis system. Laticifer rows were limited in number during the immature phase. The laticifer structures seem to form well-developed lateral interconnections similar to typical mature trees. The formations of stone cells were also noticed towards the outer region of the bark which was evident from the microscopic observations, followed by periderm development. The anastomose network was formed by the dissolution of end walls and also by the lateral interconnections which were evident at the anatomical level. Multiseriate rays dominate the uniseriate rays and biseriate rays in comparison. Data regarding dimensional features of phloem rays, latex vessels and inclination of laticifers in the juvenile phase was also obtained from the study. The information about anatomical features in the immature phase is valuable for researchers doing breeding experiments and clonal selection in *Hevea*.

**Keywords:** Laticifers, Bark anatomy, *Hevea brasiliensis*, Immature seedling.

### INTRODUCTION

Laticifers or latex vessels are specialized cells that possess latex and the occurrence of such cells has been reported in various plants belonging to dicots, monocots and even pteridophytes (Bras, 1957; Metcalfe, 1967; Romberger, *et al.*, 1995). The milky latex of *H. brasiliensis* (para rubber) is the sole source of Natural Rubber (NR) for the rubber





### Philipose Omman

industry. Compared to any other latex yielding plants, *H. brasiliensis* stands top as it possesses very high NR content (Raghavendra, 1991). Anatomically *Hevea* bark consists of two zones, inner soft bark and outer hard bark (Bryce and Campbell, 1917). Based on the laticifer's nature with the occurrence of stone cells in the secondary phloem, Omman and Reghu (2008) designated the various zones of the bark of *Hevea* as soft bark, inner hard bark and outer hard bark. Laticifers are differentiated from the fusi form initials of the cambium, in the form of concentric rings, alternating with other phloic elements such as sieve tubes, companion cells, phloem fibres, axial parenchyma and ray parenchyma. Due to the continued activity of the vascular cambium, new laticifers are differentiated and the older ones are pushed outwards. The outer zone of bark is hard due to the occurrence of a copious amount of sclerified stone cells. Laticiferous system has been considered as the site of rubber synthesis in *H. brasiliensis* (Dickerson, 1965; Southorn, 1966; Gomez, 1966).

In the cross-section of bark, latex vessels appear as more or less circular in shape and remain almost parallel to the cambium. In radial longitudinal planes, latex vessels look like tubular structures in different rows. The rows are arranged as straight tubes running in between other phloic tissues. Most of the researchers reported the absence of radial connections between laticifer rows (Arens, 1911; Meunier, 1912; Kaimal, 1951). In tangential longitudinal sections, laticifers resembled an anastomosing network of tubes, weaving round the phloic rays (Omman and Reghu, 2003). The present system of tapping was formulated based on various experiments conducted on the anatomy and physiology of *Hevea* (De Jong 1916; Bobilioff, 1923; Mass, 1925). A detailed anatomical investigation conducted by Omman and Reghu (2008) in the mature clones of *H. brasiliensis* revealed that the inclination of laticifers is a clonal character. The present investigation aimed to understand the nature, inclination and distribution of laticifers and certain other characters associated with them in the immature seedling plants of *Hevea*.

## MATERIAL AND METHODS

Bark samples were collated from the hybrid seedling progeny of Wickham x Brazilian at the age of 4 years. Samples were collected from the selected trees (10 plants) at the height of 20-30 cm from the ground, with a size of 2 x 2 cm. The samples collected were fixed in formalin-acetic -alcohol (FAA) and were sectioned at 30 – 60 µm thickness at different planes viz. cross-sectional (CS), tangential longitudinal (TLS) and radial longitudinal (RLS) plane, using Reichert Jung sledge microtome. Sections were stained with Oil Red O (Omman and Reghu, 2003) and mounted in 50% glycerine and the micro slides were prepared for anatomical observations.

The bark sections were observed under Leitz Aristoplan Research microscope attached to Leica Q 5000 I W Image Analysis System. The images of the bark sections documented in the Image Analysis System were used to measure the inclination of laticifers / phloic rays and other anatomical traits employing Leica Q Win V.2.1 Image analysis software. The TLS of the bark was used to measure the inclination, density and diameter of laticifers and frequency of interconnections. Cross-section and RLS were used to count the number of laticifer rows and inter-row distances. For each anatomical parameter, observations from ten microscopic fields were taken per plant and the average has been taken and considered as the data of the progeny. Anatomical characters quantified from the study are a) the number of laticifer rows; b) distance between laticifer rows c) inclination of laticifers and phloic rays d) latex vessel density per unit distance, e) latex vessel diameter f) frequency of interconnections per unit area and g) ray height and width.

## RESULTS AND DISCUSSION

Anatomically it is observed that laticiferous system is formed as a concentric ring of tubes differentiated from the fusiform initials of the cambium. In the TLS plane latex vessels appear as tube like cells running in the vertical direction of the stem in the secondary phloem (fig1 a). They are cylindrical rows from the cambium to the periphery. The newest rows occur near the cambium and when the phloem derivatives are formed and pushed towards the outside, the old laticifer rows are also pushed to the outside. The phloem tissue system near the cambium is termed





**Philipose Omman**

soft bark (SB) where the area is devoid of stone cells. Due to the absence of stone cells, the latex vessels have no disruption for their connectivity. Hard bark (HB) is the area outside the SB where the presence of sclerified stone cells are noticed.

During the network structural formation of laticiferous system, it is observed that small elongated laticifer cells meet with their end walls and long tube-like structures are formed by the dissolution of these end walls (Fig.1 b). Similarly, the small projection-like structures formed from the lateral walls meet the nearby counterpart (fig.1 c), resulting in an articulated anastomosed connected concentric network of laticifer rows. Latex vessels recorded a mean diameter of (19.3 $\mu$ m) and an average frequency of interconnection of 18 was also recorded. The latex vessels showed an inclination to the rightward direction at an angle of 3.4° and phloic rays showed 2.9° to right. The RLS sections show that the two adjacent rows never form any connection which is clear from (Fig.1 d). An average of 6.3 latex vessel rows is present with 9.4  $\mu$ m distance apart. Sections of the radial longitudinal plane indicated that latex vessels appear as tubular structures and in cross-sectional (CS) plane; latex vessels were circular in nature (Fig.1 e).

The occurrence of sclerified stone cells was absent in the SB region. But towards the peripheral region, stone cells were identified (Fig. d and e, yellow arrowhead). Periderm formation was also noticed as an outermost protective tissue system of the secondary phloem (Fig.1 d). Ray parenchyma cells were predominantly including multiseriate types (Fig.1 blue arrowhead), and rare occurrence of uniseriate (Fig.1 c yellow arrowhead) and biseriate rays (Fig.1 c Black arrowhead). The proportion of multiseriate, biseriate and uniseriate rays is 6.1, 0.56 and 1.15 respectively per unit distance. Phloem rays exhibited an average length of 293.2  $\mu$ m and a width of 35.2  $\mu$ m. The origin of laticiferous system in *Euphorbia* species, may be considered as originated from few initials present in the embryo (Schaffstein, 1932; Rosowski, 1968). Scott (1882) based on his studies in germinating seeds of *Hevea* considered that latex vessels were elongated cells with granular content and dissolution of cross walls took place during the stage of root growth. Calvert (1887) identified three systems of laticifers in the stem of *Hevea*: hypodermal, principal and medullar. But Milanez (1946, 1948, 1951) later found that the primary laticiferous system is differentiated from the procambium in the vicinity of the phloem. Elaborative anatomical studies conducted by Gomez (1982) confirmed that the principal system of primary laticifers is observed in the procambial region belonging to the primary phloem proper. Bobilioff (1918) characterized two modes of laticifer ontogeny in *Hevea*, the first one is by the dissolution of cross walls of a row of cells and the other by extension of the growth of certain cells. The first type of development of secondary laticifers in *Hevea* was later confirmed by Panikkar (1974) and Xiuqian (1987). The present anatomical observation also confirmed a similar view. The laticifer initials are joined by the dissolution of the end walls and further small projections are formed on the lateral walls which come in contact and fuse to form the anastomose network, within a row.

Laticifer rows in the present investigation show a reduction in number compared to mature trees (Omman and Reghu, 2013) which may be due to the age of the plants. Plants in the immature phase would have less secondary phloem production. The same study conducted in mature clones indicated that the number of laticifer rows ranges on an average of 20-40, from both soft bark and inner hard bark region and the character exhibited clonal variation (Omman and Reghu, 2013). The number of laticifer rows has been reported as a quantitative anatomical parameter on latex yield in *H. brasiliensis* (Bobilioff, 1923; Gomez, 1966). The correlation of this trait with yield has been proved by many workers in *Hevea* (Bobilioff 1920; Taylor, 1926; Rubber research institute, Malaya, 1964, 1966, 1968; Narayanan *et al.*, 1973; Narayanan *et al.*, 1974). Hence the anatomical result concerning laticifer rows in the early immature is highly useful and significant, and this can be used for the early selection of genotypes.

The distance between laticifer rows has been considered as a yield-determining character in *Hevea* (Paiva *et al.*, 1982). Gomez *et al.*, (1972) noted considerable variation in the average distance between laticifer rows in different clones. The number of latex vessels within a row in the unit distance is termed as the density of latex vessels. Gomez *et al.*, (1972) reported higher density in the soft bark than that of hard bark and this trait has been identified as a potential trait for crop improvement programs (Abraham *et al.*, 1992). Clonal variability in the frequency of interconnections





### Philipose Omman

between latex vessels has been reported by Premakumari *et al.*, (1984; 1991). Studies conducted by Ashplant (1927; 1928a; 1928b; 1928c) suggested that latex vessel diameter was an important factor that determines the latex yield.

In the present investigation, the laticiferous system denoted well-established lateral interconnections within a row and narrated its anastomose nature. Clonal variability in the frequency of interconnections between latex vessels has been reported by Premakumari *et al.*, (1984; 1991) and opined that this trait had only low or moderate genetic advance along with high heritability estimates. The authors further pointed out that the number of interconnections per unit distance within the laticifer rows depend on the density and diameter of latex vessels. A similar finding of clonal variability in ten *Hevea* clones was reported by Omman and Reghu (2013). In mature trees under exploitation, latex vessel diameter has been reported as an important factor that determines the latex yield (Ashplant, 1927; 1928a; 1928b; 1928c). Simple correlations among yield, girth, bark thickness, number of laticifer rows and diameter of latex vessels have been reported earlier by various researchers. (Gomez *et al.*, 1972; Ho *et al.*, 1973; Narayanan *et al.*, 1973; Ho, 1972, 1976; Sethuraj, 1981; Premakumari and Panikkar, 1989).

The inclination of latex vessels and phloic rays in the present investigation suggests that the latex vessels and phloic rays can attain an inclination pattern in the immature phase itself. Studies conducted by many authors (Petch, 1911; De Jonge, 1916; Gomez and Chen, 1967) proved that latex vessels and phloic elements were inclined towards right (3-5°) to the vertical of the tree. The modern system of tapping in *Hevea* (Vijayakumar *et al.*, 2000; Lukman, 1983) is designed based on the inclination of laticifers (Gomez and Chen, 1967). Studies conducted in 10 mature clones of *Hevea*, Omman and Reghu, (2008) revealed that the inclination of laticifers is a clonal character that may be inclined to the left or right or may have both leftward and rightward inclination. So the inclination result of the present investigation suggests that in future inclination pattern studies can be conducted in the immature phase and can be correlated with the mature phase in the same plant to assess any variation in inclination during the growth of the plant. Moreover, for the early selection procedure, this can be included as a criterion.

## CONCLUSIONS

The present investigation throws light into the anatomical peculiarity of laticifers in the seedling trees. This investigation also narrates the anatomical interpretation of how the laticifers form an anastomose network in the bark during the growth and development of the secondary phloem in *Hevea*, especially during the immature early stage of the plant. Moreover, the inclination pattern of laticifers in the immature phase is also an indication that can be used as a character in the early selection of *Hevea* clones.

## ACKNOWLEDGEMENT

The authors is highly grateful to the Director, Rubber Research Institute of India for providing facilities to conduct the investigation in the institute. The author is also indebted to the University Grants Commission, Government of India for awarding FIP to undergo research.

## REFERENCES

1. Abraham S.T., Reghu C.P., Madhavan J., George P.J., Potty S.N., Panikkar A.O.N. and Saraswathy P. (1992). Evaluation of *Hevea* germplasm: 1. Variability in early growth phase. *Indian Journal of Natural Rubber Research*, 5 (1&2): 195-198.
2. Arens P. (1911). Bijdrage tot de Kennis der melksapvaten van *Hevea brasiliensis* en *Manihot glaziovii*. (Contribution to the knowledge of the latex vessels of *Hevea brasiliensis* and *Manihot glaziovii*). *Meded v.h. Alg. Proefst. Op Java- Salatiga Cultuurgids*, 13 (2): 49-60.
3. Ashplant H. (1927). Investigations into *Hevea* anatomy. *Bull. Rubb. Grow. Assn.*, 9: 571.





### Philipose Omman

4. Ashplant H. (1928 a). Investigations into *Hevea* anatomy. *The Planters' Chronicle*. 23: 469.
5. Ashplant H. (1928 b). Latex tube bore. *Bull. Rubb. Grow. Assn.* 10: 769.
6. Ashplant H. (1928 c). Yield variability in *Hevea brasiliensis*. *Nature*, 121: 1018.
7. Bobiloeff W. (1918). Het verband tusschen de anatomie van den bast on de productie bij *Hevea brasiliensis*. (The relation between anatomical structure of the cortex and the yield of *Hevea brasiliensis*). *Archief v.d. Rubbercult* 2: 488.
8. Bobiloeff, W. (1920). Correlation between yield and number of latex vessel rows of *Hevea brasiliensis*. *Arch. v.d. Rubberc.* 4: 391 pp.
9. Bobiloeff W. (1923). Anatomy and Physiology of *Hevea brasiliensis*. *Zurich. Institute Orell Fussli*.
10. Bras J.L. (1957). Rubber: Fundamentals of its science and technology. *Chemical Publishing Co. Inc.*, New York. p 47.
11. Bryce G. and Campbell L.E. (1917). On the mode of occurrence of latex vessels in *Hevea brasiliensis*. *Agric. Dep. Ceylon, Bull.* No. 30
12. Calvert A. (1887). The laticiferous tissue in the stem of *Hevea brasiliensis*. *Annals of Botany*, 1: 75.
13. De Jong A.W.K. (1916). Wetenschappelijke tapproeven bij *Hevea brasiliensis*. *Meded. Agric. Chem. Lab. Buitenz.* 14: 1
14. Dickerson P. B. (1965). The ultrastructure of the latex vessel of *Hevea brasiliensis*. *Proc. Nat. Rubb. Pro. Res. Ass. Jubilee Cof.*, Cambridge, 1964. L. Mullins (Ed.), Maclaren and Sons Ltd. London. pp52.
15. Gomez J.B. (1966). Electron microscopic studies on the development of latex vessels in *Hevea brasiliensis* Mull. Arg. Ph. D. thesis, University of Leeds.
16. Gomez J.B. (1982). Anatomy of *Hevea* and its influence on latex production. *MRRDB Monograph No. 7*, Kuala Lumpur.
17. Gomez J.B. and Chen K.T. (1967). Alignment of anatomical elements in the stem of *Hevea brasiliensis*. *Journal of Rubber Research Institute of Malaya*, 20 (2): 91-99.
18. Gomez J.B., Narayanan, R. and Chen, K.T. (1972). Some structural factors affecting the productivity of *Hevea brasiliensis*: I. Quantitative determination of the laticiferous tissue. *Journal of Rubber Research Institute of Malaya*, 23 (3): 193-203.
19. Ho C.Y. (1972). Investigations on shortening the generative cycle for yield improvement in *Hevea brasiliensis*. M.Sc. Thesis, Cornell University, U.S.A.
20. Ho C.Y., Narayanan R. and Chen K.T. (1973). Clonal nursery studies in *Hevea* I. Nursery yields and associated structural characteristics and their variations. *Journal of Rubber Research Institute Malaya*, 23 (4): 274.
21. Kaimal K.N. (1951). The bark of the mature rubber tree. *India Rubber Board Bulletin*.
22. Mass J.G.G.A. (1925). The tapping system of *Hevea brasiliensis* on experimental basis. Summary. *Archf. Rubbercult.*, 9: 209.
23. Metcalfe C.R. (1967). Distribution of latex in the plant kingdom. *Econ. Bot.* 21: 115-127.
24. Meunier A. (1912). L'Appareil laticifers des caoutchoutiers. Imprimerie Industrielle and Financiere, Bruxelles.
25. Milanez F.R. (1946). Nota Previa sobre os laticiferos de *Hevea brasiliensis*. *Arquivos do servico Florestal do Brasil*, 2: 39.
26. Milanez F.R. (1948). Segunda nota sobre laticiferos. *Lilloa*, 16: 193pp
27. Milanez F.R. (1951). Galactoplastas de *Hevea brasiliensis* Muell. Arg. *Arquivos do Jardim. Botanico de Rio de Janeiro*, 11: 39pp.
28. Narayanan R., Ho C.Y. and Chen K.T. (1974). Clonal nursery studies in *Hevea* III. Correlation between yield, structural characters, latex constituents and plugging index. *Journal of Rubber Research Institute of Malaysia*, 24 (1): 1-14.
29. Narayanan, R., Gomez, J.B. and Chen, K.T., (1973). Some structural factors affecting productivity of *Hevea brasiliensis*. II. Correlation studies between structural factors and yield., *Journal of Rubber Research Institute of Malaya*, 23: 285..
30. Omman P. and Reghu C.P. (2003). Staining procedure for laticiferous systems of *Hevea brasiliensis* using Oil Red O. *Indian Journal of Natural Rubber Research* 16 (1 & 2) 41- 44.





### Philipose Omman

31. Omman P. and Reghu C.P. (2008). Inclination of laticifers and phloic rays in ten clones of *Hevea brasiliensis*. *Indian Journal of Natural Rubber Research*. 21 (1&2) 47-66.
32. Omman P. and Reghu C.P. (2013b). Clonal variation in the quantitative traits of laticifers in *Hevea brasiliensis*. *Rubber Science*: 26 (2): 279-289.
33. Paiva J.R.D., Rossetti A.G. and Goncalves P.D.S. (1982). Use of path coefficient in *Hevea brasiliensis* breeding. *Pesquisa Agropecuaria Brasileira*, 17 (3): 433-440.
34. Panikkar, A. O. N. (1974). Anatomical studies in *Hevea brasiliensis*. PhD thesis, Birla Institute of Technology and Science, Pilani, India.
35. Petch T. (1911). Tapping experiments and their teaching: In " *The physiology and diseases of Hevea brasiliensis*, III. Dulau, London.
36. Premakumari D. and Panikkar A.O.N. (1989). An attempt to improve test tapping in *Hevea* seedlings. *Journal of Plantation Crops*, 18 (Supplement): 383-387.
37. Premakumari D., Panikkar, A.O.N. and Shankar S. (1991). Comparative bark anatomy of three induced polyploids of *Hevea brasiliensis* a (willd. ex.a.juss). *Journal of Plantation Crops*, 18 (supplement): 17-23.
38. Premakumari D., Sasikumar, B., Panikkar, A.O.N. and Marattukalam, J.G. (1984) Variability and association of certain bark anatomical traits in *Hevea brasiliensis* Muell Arg. *Placrosym VI*: 49-54.
39. Raghavendra A.S. (1991). Latex exudation from rubber tree, *Hevea brasiliensis*. In. *Physiology of Trees* (Ed. A.S. Raghavendra). John Wiley & Sons. Inc., New York pp. 403-417
40. Romberger J. A., Hejnowicz and Hill J.F. (1995). Plant structure: Function and development. *Springer-Verlag*. Berlin Heidelberg, New York. p 135.
41. Rosowski J R (1968). Laticifer morphology in the mature stem and leaf of *Euphorbia supina*. *Botanical Gazette*. 129, 113-120
42. Rubber Research institute of Malaya (1964) *Rep. Rubb. Res. Inst. Malaya*, 1963, 30.
43. Rubber Research institute of Malaya (1966) *Rep. Rubb. Res. Inst. Malaya*, 1965, 25.
44. Rubber Research institute of Malaya (1968) *Rep. Rubb. Res. Inst. Malaya*, 1967, 26.
45. Schaffstein G. (1932). Untersuchungen an ungliederten Milchrohren. *Beih Bot. Centralbl.* 49: 197-220.
46. Scott D.H. (1882). The development of articulated laticiferous vessels. *Quart. J. Micr. Sci.*, 22: 136.
47. Sethuraj M.R. (1981). Yield components in *Hevea brasiliensis*: Theoretical considerations. *Plant, cell and environment*, 4: 81-83.
48. Southorn W.A. (1966). Electron microscopic studies on the latex of *Hevea brasiliensis*. *Proc. 6<sup>th</sup> Int. Congr. Electron Microsc.* Kyoto 1966. 2: 385. Tokyo: Maruzen Co., Ltd. Nihonbashi.
49. Taylor R.A. (1926). The interrelationship of yield and the various vegetative characters in *Hevea brasiliensis*. *Rubb. Res. Sch. Ceylon Bull.*, 43.
50. Vijayakumar, K.R., Thomas, K.U. and Rajagopal, R. (2000). Tapping. In: (eds: *Natural Rubber: Agromanagement and Crop Processing*) George, P.J. and Kuruvilla Jacob, C., Rubber Research Institute of India, pp. 215-238.
51. Xiuqian Zhao, S. (1987). The significance of the structure of laticifer with relation to the exudation of latex in *Hevea brasiliensis*. *Journal of Natural Rubber Research.*, 2: 94-98





**Philipose Omman**

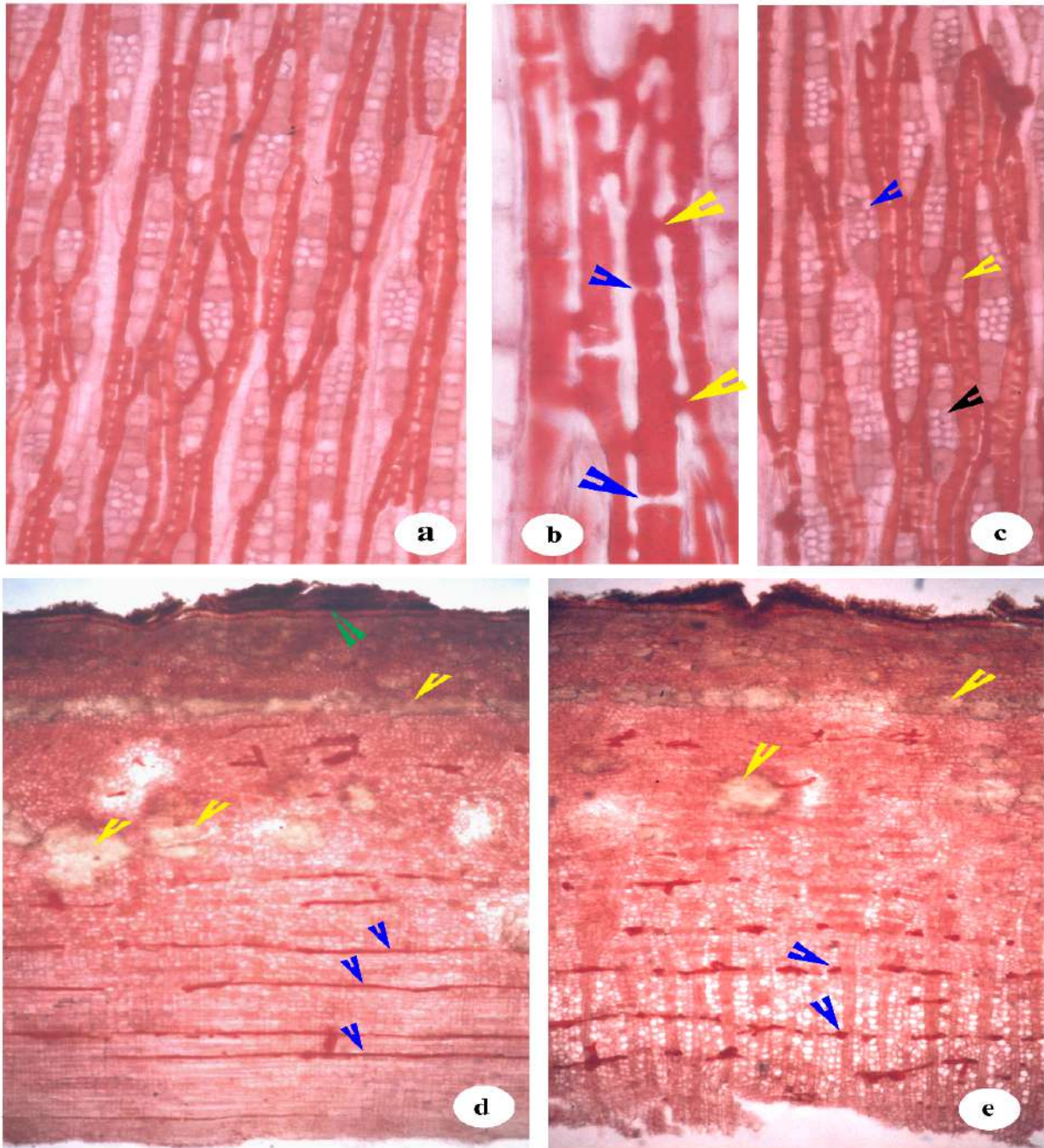


Figure 1. Bark sections stained in Oil Red O. a-Latex vessels stained showing anastomose network. b- arrows indicate meeting points of latex vessels for dissolution, end to dissolution (blue arrow), also note lateral joining (yellow arrow). c-latex vessels contiguous to rays, note uniseriate rays (yellow arrow), biseriate (black arrow) and multiseriate rays (blue arrow). d- RLS shows latex vessels as tube like structures representing rows (blue arrow), Periderm formation is also evident (green arrowhead). e-CS shows circular ends of latex vessel tubes in rows (blue arrow). a, c- X75, b- 125X, d,e – 10X





## The Physico-Chemical and Hydrogeochemical Properties of Potable Water from Kolasib District, Mizoram, India

Malsawmtluanga<sup>1\*</sup>, John Blick<sup>1</sup>, Rebecca Laduhawmi<sup>2</sup>, Joney Lalnunpuii Pachuau<sup>3</sup> and Malsawmtluangi<sup>4</sup>

<sup>1</sup>Assistant Professor, Department of Geology, Lunglei Govt College, Lunglei, Mizoram-796701, India.

<sup>2</sup>Assistant Professor, Department of Zoology, Lunglei Govt College, Lunglei, Mizoram-796701, India.

<sup>3</sup>Assistant Professor, Department of Botany, Govt Champhai College, Champhai, Mizoram-796321, India.

<sup>4</sup>Assistant Professor, Department of Botany, Govt Serchhip College, Serchhip, Mizoram-796181, India.

Received: 28 Oct 2021

Revised: 18 Nov 2021

Accepted: 06 Jan 2022

### \*Address for Correspondence

#### Malsawmtluanga

Assistant Professor,

Department of Geology,

Lunglei Govt College, Lunglei,

Mizoram-796701, India.

Email: mstmzu.gps@gmail.com



This is an Open Access Journal / article distributed under the terms of the **Creative Commons Attribution License** (CC BY-NC-ND 3.0) which permits unrestricted use, distribution, and reproduction in any medium, provided the original work is properly cited. All rights reserved.

### ABSTRACT

The ever increasing population often lead to depletion of natural resources and increase of pollution. Potable water is often polluted with different harmful contaminants and there is a need to know whether our water sources are safe and uncontaminated. This paper deals with the assessment of hydrogeochemical and physico-chemical assessments of different water sources in and around Kolasib town in North East India. In this study, we try to establish the physico-chemical parameters within the different water sources, to demarcate the water quality which are not within the prescribed BIS 10500: 2012 standards and to understand the dominant water facies of the geological areas. The 30 water samples from different water sources from Kolasib district were collected for the study. The water samples were sampled and collected as per the American Public Health Association and the American Water Works Association standards.

**Keywords:** Water, quality, geology, Kolasib, North East India.

### INTRODUCTION

Water is the most essential resource to man. The water we consume should not only be safe, affordable and sufficient, but also easily accessible for household, domestic consumption, agriculture, developmental activities and other purposes. Clean water and its management is vital for any society's growth and progress. With the population of India reaching 1.2 billion in the 2011 Census conducted by the Ministry of Home Affairs, Govt of India, the need for clean and potable water is increasing day by day. Since water utilization directly impact our health, growth and



**Malsawmtluanga et al.,**

every aspect of life [1]. To achieve and meet the United Nations Sustainable Goal of *Clean Water and Sanitation* for all, it is utmost necessary that clean potable water is easily accessed by all. The study area is Kolasib town and its adjacent villages. Kolasib is one of the 8 districts in the state of Mizoram in India. Mizoram is a small state in the North East Region of India and it shares two international boundaries and the state is sandwiched between Myanmar in the east and by Bangladesh to its west. This hilly mountainous district is bordered by the state of Assam to its north. The total geographical area of the district is 1382. 51 sq km and Kolasib town is the administrative headquarters for the district with a high literacy rate of 94.52%. The domestic water supply is from the state government (PHED). Besides this, water from springs and streams, which are seepages from the groundwater and manual hand pumps serve as the secondary water sources for many households, agriculture, livestock etc in the district.

Problems and deterioration of quality of potable water is due to many reasons: Pollution, over exploitation, population explosion, rapid industrialization, mismanagement of water resources etc. The rural population of India depend heavily on the groundwater for their different needs [2]. Water pollution affects drinking water, rivers, lakes and all the other water bodies [3]. This is why many studies have been taken recently to assess the water bodies to determine their quality in many parts of mainland India [4-11]. Also, from the North East India region, many researchers have studied about the quality of potable water in different states [12-16]. In Mizoram too, the potable water quality have been studied by many workers to assess their quality and nature [17-20]. The rocks of the study area are of Bhuban and Bokabil formations of the Surma group which are from Upper Oligocene to Miocene in age. The rocks of Mizoram are mostly sandstones, shales and siltstones which are Paleogene to Neogene in age. The rocks vary from 20°-50° either towards East or West [21]. And the rocks are mostly of Barail (Oligocene), Surma (Paleogene to Neogene) and Tipam group (Late Miocene to Early Pliocene). Many of the locations of the study area near Kolasib town are assigned Middle Bhuban of Surma group which are correlated from magnetostratigraphic studies [22].

## MATERIALS AND METHODS

The perennial springs (local name – tuikhurs), public water supply and hand pumps were selected for study as these sources of water were the most used amongst the local inhabitants in the villages within the study areas. These tuikhurs and manual hand pumps are perennial water sources, however their quantity are limited in the lean dry months. *Water samples from each location were collected for detailed studies during the pre South-West Monsoon months of 2021.* The water samples from each location were collected in clean plastic *Tarson* 1 litre water sample bottles by using standard techniques [23] following the grab sampling method. Sample bottles were rinsed, cleaned and washed first with acidic water and rinsed again with the water from the water source where the sample was to be taken. Out of the 30 samples, 4 samples were from hand pumps, 12 samples from tuikhurs and 14 samples were from the public supply water. To avoid any leak and spillage, all caps were tightly sealed after sampling. Water samples were tested in-situ for the pH, Hardness, TDS and EC were measured with *Eutech* digital instruments. Using Titrimetric method chemicals like Ca, Mg, Cl, SO<sub>4</sub> and the alkalinity property were analysed. UV-Spectrophotometric analysis was used for detecting NO<sub>3</sub>. For HCO<sub>3</sub> analysis, acid titration method was carried out. Elements for Na, K and Fe were analysed using *Korvio Neer* digital instruments. All the results obtained were then compared with BIS (IS 10500: 2012) standards.

Piper Trilinear classification of major ions has contributed extensively to the understanding of groundwater movement, and hydrochemistry (Dalton and Upchurch, 1978). The concentrations of the six ions viz. Ca, Mg, Na<sup>+</sup>, K and HCO<sub>3</sub>, SO<sub>4</sub>, Cl were converted into mEq/l. Based on convention, three cations and three anions were plotted relative to one another.





## RESULTS AND DISCUSSION

The physico-chemical parameters result obtained are presented in Table 1 and 2 with sample code name for sub-surface water, public water supply water and groundwater as SSW, XPW and GDW respectively. These were then compared with the Bureau of India Standards 10500: 2012 for drinking water. From the results it can be infer that the pH varies from 7.0 to 7.5, which are found to be well within the permissible limits. The EC contents of the sample analysed were very low compared to the standard prescribed by BIS (66  $\mu\text{mhos/cm}$  to 142  $\mu\text{mhos/cm}$ ). This result may happen because of low concentration of various cation & anion and some specific mineral in the rock of the aquifer. In addition, the aquifer of the rock may have more silica bearing minerals. The EC for GDW samples analysed in 11 and 12 are observed high because the interactivity of water bodies and various minerals may increase more ions. TDS observed in samples ranging from 43–123 mg/l showing the consistency with EC analysed. The presence of microscopically dispersed insoluble matters may give rise the TDS in SSW-04 and SSW-21. *The value of 500 mg/l of TDS is desirable in drinking water. Turbidity observed in all the samples are less than the permissible value of 5 NTU.* The increase in Sodium level may rise alkalinity content observed in SSW-05, XPW-25 and SSW-28. The water bodies with more dissolved salts indicates more alkalinity level. Alkalinity of the samples analyzed has been observed with values ranging between 25 mg/l to 64 mg/l. The Alkalinity, lower than 200 mg/l is suitable for human consumption. The major primary elements that contribute hardness in water are Ca and Mg salts. The Hardness value obtained in the samples were low from 32–58 mg/l. The concentration of Chloride amount obtained were all under the permissible limits of 250 for BIS 10500: 2012. The samples of the hand pumps obtained higher Fe content than the tuikhurs. The BIS standard level for Fe is 0.3 mg/l. The samples in all the hand pumps have surpassed the required value of Fe due to the corrosive nature of handpump equipment. Since these handpumps are made from steel, the pumped groundwater interacted with the handpump inner pipes as they approach the land surface resulting in release of Fe into the water. However, since Fe is a minor impurity; no direct influence on human health.

The concentrations of Na were generally high from 4.35 mg/l to 14.09 mg/l. In all the samples, the physico-chemical parameters in all the water sources are much lower than the standard value given by BIS 10500: 2012. K level in the tuikhur and handpump samples were observed between 0.25 mg/l to 2.47 mg/l. Though the presence of K may be regulated by biological condition; the low level of K in the study area may be due to the presence of numerous solidities of K silicate minerals. *The values of Ca obtained from 3.11 to 6.34 mg/l which are below the permissible limit given by BIS. Ca in tuikhur exhibits more value than in supplied water samples. The exception of XPW samples 04, 10 and 20, where the public water supply shows higher values of Ca.*

*The Mg concentrations ranges from 3.13 mg/l to 6.11 mg/l, where relatively higher values in SSW in 01, 02, 05 and 06 suggest the presence of shale-dominated host rocks. While SSW from 03, 14, 21 and 23 have relatively much sandy composition of sandstone. The present study area of the rock belongs to the Bhuban Formation which consists of intercalation of sandstone-shale dividing the two without having a distinct bedding planes.* The levels of  $\text{NO}_3$  were very low in all the water sources, obtaining the value of 0.11 to 0.64 mg/l. This result happened because of the less usage of fertilizers, denitrification and nitrate assimilation. The concentration of  $\text{SO}_4$  in all the stations are low ranging from 1.08 mg/l to 4.61 mg/l.

The cation and anion values of collected samples taken from the study area are plotted and shown on Piper trilinear diagram in Fig. 3. This major ion composition is used to classify groundwater and sub-surface waters into various types based on Piper-Hill diagram to conclude various hydro-geochemical compositions. For better understanding and getting more information of the hydro-geochemical relationships of different areas, Piper illustrated diagram is broadly used than any other plotting methods available. According to the plotted Piper diagram obtained, the study area was classified as  $\text{Na} > \text{Ca} > \text{Mg} > \text{K}$  facies, but few of the water sources are more dominance replacing Na by Ca. From the order of abundance of ions i.e.  $\text{NO}_3 < \text{SO}_4 < \text{Cl} < \text{HCO}_3$ , it specifies that alkaline earths and weak acids surpass alkalis and strong acids respectively. Consequently, the general hydrogeo chemistry of the study area are swayed by weak acids and alkaline earth metals.  $\text{HCO}_3$  value in all the water sources are more than Cl and  $\text{SO}_4$ . The general facies of the study area exist as  $\text{Ca-Na-HCO}_3$ , but appear to  $\text{Ca-Mg-HCO}_3$  facies in few stations replacing Na





**Malsawmtluanga et al.,**

by Mg. A ternary cation diagram of different water sources was controlled by  $K^+Na$ . From the cation plot, Ca, Mg, and  $Na+K$  clustered and fall between 21-56%, 17-36% and 26-59% respectively.  $HCO_3^-$  of 90% in all water sources clustered fall in the plotted ternary triangle resulting the main dominant anion. It is observed that there is no notable alteration in the facies of hydrogeochemical specifying that the ions (major salt) present in those stations are natural in existence. The hydrogeochemical classification of the study area can be classified as Ca-Na- $HCO_3^-$  facies as the geology of the study area is sedimentary rocks of shale and sandstone.

**CONCLUSION**

The physico-chemical and hydrogeochemical assessment from different water sources in and around Kolasib town were assessed under BIS 10500:2012. All the 30 different water samples collected from the different water sources were under the norms and are fit for domestic consumption, agriculture, irrigation, developmental and other uses. All the tuikhurs, hand pumps and the public water supplied were suitable and fit for domestic consumption and other purposes.

**REFERENCES**

1. El Khanji S, Hudson J: Water utilization and water quality in endogenous economic growth. *Environment and development economics*. 2016; 21(5), 626-648.
2. Shyamala R, Shanthi M, Lalitha P: Physicochemical analysis of borewell water samples of Telungupalayam area in Coimbatore district, Tamilnadu, India. *E-Journal of chemistry*. 2008; 5(4), 924-929.
3. Juneja T, Chaudhary A: Assessment of water quality and its effects on the health of residents of Jhunjhunu district, Rajasthan: A cross sectional study. *Journal of public health and epidemiology*. 2013; 5(4), 186-191.
4. Jindal A, Dixit S: Pre-and post-monsoon variation in physico-chemical characteristics in groundwater quality of Bhopal "The City of Lakes" India. *Asian Journal of Experimental Sciences*. 2008; 22(3), 311-316.
5. Tiwari R, Nayak S: Drinking water and sanitation in Uttar Pradesh: A regional analysis. *Journal of Rural Development*. 2013; 32(1), 61-74.
6. Bhat SA, Pandit AK: Surface water quality assessment of Wular Lake, a Ramsar site in Kashmir Himalaya, using discriminant analysis and WQI. *Journal of Ecosystems*. 2014.
7. Appavu A, Thangavelu S, Muthukannan S, Jesudoss JS, Pandi B: Study of water quality parameters of Cauvery river water in erode region. *Journal of Global Biosciences*. 2016; 5(9), 4556-4567.
8. Bharathi HR, Manjappa S, Suresh T, Suresh B: Evaluation of water quality index of water bodies Channarayapatna taluk, Karnataka region, India. *International Journal of Applied Sciences and Biotechnology*. 2016; 4(4), 475-482.
9. Acharya S, Sharma SK, Khandegar V: Assessment of groundwater quality by water quality indices for irrigation and drinking in South West Delhi, India. *Data Brief*. 2018; 18, 2019-28.
10. Pallavi S, Shivaraju HP: Assessment of drinking water quality and hazard events in water supply system in Mysuru city, Karnataka, India. *International Journal of Applied Environmental Sciences*. 2019; 14(5), 555-569.
11. Vashisht D, Kumar A, Mehta SK, Ibhaddon A: Analysis of emerging contaminants: A case study of the underground and drinking water samples in Chandigarh, India. *Environmental Advances*. 2020; 1, 100002.
12. Singh EJ, Gupta A, Singh NR: Groundwater quality in Imphal West district, Manipur, India, with multivariate statistical analysis of data. *Environmental Science and Pollution Research*. 2013; 20(4), 2421-2434.
13. Das BK, Boruah P, Kar D: Study of seasonal variation of water quality of River Siang in Arunachal Pradesh, India. *IOSR Journal of Environmental Science, Toxicology and Food Technology*. 2014; 8(2IV), 11-20.
14. Puzari A, Khan P, Thakur D, Kumar M, Shanu K, Chutia P: Quality assessment of drinking water from Dimapur district of Nagaland and Karbi-Anglong district of Assam for possible related health hazards. *Current World Environment*. 2015; 10(2), 634.
15. Singh AK, Kumar SR: Quality assessment of groundwater for drinking and irrigation use in semi-urban area of Tripura, India. *Ecology, Environment and Conservation*. 2015; 21(1), 97-108.





**Malsawmtluanga et al.,**

16. Ahamad KU, Medhi N, Kumar V, Nikhil N: Water Quality Evaluation in a Rural Stretch of Tezpur, Assam (India) Using Water Quality Index and Correlation Matrix. *Trends in Asian Water Environmental Science and Technology*. 2017; 169-180.
17. Kumar S, Bharti VK, Singh KB, Singh TN: Quality assessment of potable water in the town of Kolasib, Mizoram (India). *Environmental Earth Sciences*. 2010; 61(1), 115-121.
18. Lalchhingpuii SL, Lalramnghinglova H, Mishra BP: Assessment of the water quality of Tlawng river in Aizawl, Mizoram. *Sci Vis*. 2011; 11, 72-76.
19. Bharati VK, Kumar S: Investigation of some metals and heavy metals in spring (tuikhur) water in Kolasib district of Mizoram. *Traditional Knowledge*. 2013; 170
20. Blick J, Kumar S, Bharati VK, Kumar S: Status of arsenic contamination in potable water in Chawngte, Lawngtlai district, Mizoram. *Sci Vis*. 2016; 16(2), 74-81.
21. Tiwari RP, Lalnunluanga F, Kachhara RP: Landslide Hazard Zonation–A case study along Hnahthial–Hrangchawkawn Road Section, Lunglei District, Mizoram. In *Proc. of International Conference on Disaster & Management, Tezpur University*. 1997; 461-478.
22. Lalnunluanga P, Malsawma J, Lalremruatfela C, Tiwari RP, Sangode SJ: Correlation of four magnetostratigraphically constrained sections of Miocene Bhuban Formation of Surma Basin in Mizoram, India. *Indian Miocene: A Geodynamic and Chronologic Framework for Paleobiota, Sedimentary Environments, and Paleoclimates: Paleontological Society of India, Special Publication*. 2014; 5, 87-100.
23. Association AWW, Association PHA: Standard methods for the examination of water and wastewater. *American Public Health Association (APHA): Washington, DC, USA*. 2005.

**Table 1. Results of Physico-Chemical parameters of water samples analysed**

SI No	Sample code with location	pH	EC	TDS	Tur	Alkalinity	H	Cl	Fe
1	SSW-01, Bilkhawthlir-I	7.4	100	86	2.6	44	44	8.38	0.02
2	SSW-02, Bilkhawthlir-II	7.2	132	92	2.5	36	44	7.22	0.04
3	SSW-03, Pangbalkawn-I	7.1	135	96	2.3	44	48	7.27	0.03
4	XPW-04, Pangbalkawn-II	7.0	78	87	2.1	36	44	6.29	0.04
5	SSW-05, Buhchangphai	7.0	89	64	1.3	61	42	6.28	0.83
6	SSW-06, N. Hlimen-I	7.3	96	78	1.3	25	32	9.16	0.03
7	XPW-07, N. Hlimen-II	7.4	84	89	1.4	43	44	10.4	0.04
8	XPW-08, N. Hlimen-III	7.2	98	77	1.7	25	36	9.64	0.01
9	SSW-09, Thingthelh-I	7.4	120	74	1.7	41	44	10.4	0.02
10	XPW-10, Thingthelh-II	7.3	132	97	2.3	33	44	9.12	0.02
11	XPW-11, Thingthelh-III	7.1	140	87	1.2	41	35	10.4	0.01
12	GDW-12, Thingthelh-IV	7.1	142	74	1.5	35	57	9.64	1.80
13	SSW-13, N. Thinglian	7.1	109	75	2.5	25	58	12.4	0.54
14	SSW-14, Saihapui-I	7.5	136	107	3.1	41	41	11.2	0.04
15	XPW-15, Saihapui-II	7.4	110	110	2.0	43	32	10.4	0.03
16	GDW-16, N. Thingdawl-I	7.4	105	64	2.6	36	44	10.4	1.33
17	GDW-17, N. Thingdawl-II	7.3	104	70	2.1	39	47	6.28	1.56
18	GDW-18, N. Thingdawl-III	7.3	98	72	2.1	41	36	9.12	2.11
19	SSW-19, N. Thingdawl-IV	7.2	96	86	1.4	42	44	9.67	0.03
20	XPW-20, N. Thingdawl-V	7.2	120	100	1.2	37	41	8.44	0.02
21	SSW-21, Sethawn-I	7.4	130	123	1.3	44	32	9.12	0.04
22	XPW-22, Sethawn-II	7.3	66	58	1.5	43	32	7.35	0.02
23	SSW-23, Bukvannei-I	7.3	77	78	1.4	36	32	6.54	0.02





## Malsawmtluanga et al.,

24	XPW-24, Bukvannei-II	7.1	72	43	0.9	42	47	6.43	0.03
25	XPW-25, Meidum	7.1	108	92	0.5	62	35	8.44	0.02
26	XPW-26, S. Chhimluang-I	7.3	132	83	2.6	57	46	6.54	0.04
27	XPW-27, S. Chhimluang-II	7.2	132	69	1.1	36	35	7.29	0.02
28	SSW-28, N. Chawnpui	7.1	81	65	1.9	64	48	11.2	0.03
29	XPW-29, Dilzau-I	7.0	99	64	1.1	40	57	10.2	0.02
30	XPW-30, Dilzau-II	7.0	120	103	1.2	43	48	11.1	0.02

Table 2. Results of cations-anions present in the water samples

SI No	Sample code with location	Na	K	Ca	Mg	NO <sub>3</sub>	SO <sub>4</sub>	HCO <sub>3</sub>
1	SSW-01, Bilkhawthlir-I	12.11	1.18	5.15	5.25	0.44	4.22	44
2	SSW-02, Bilkhawthlir-II	7.23	2.47	5.18	5.14	0.22	4.61	36
3	SSW-03, Pangbalkawn-I	9.34	0.64	3.11	3.17	0.25	1.34	44
4	XPW-04, Pangbalkawn-II	9.15	1.48	5.44	5.29	0.41	2.16	36
5	SSW-05, Buhchangphai	5.72	2.17	4.23	6.14	0.32	2.41	61
6	SSW-06, N. Hlimen-I	4.87	0.79	6.29	5.57	0.17	3.22	25
7	XPW-07, N. Hlimen-II	4.34	1.72	4.14	3.49	0.19	1.08	43
8	XPW-08, N. Hlimen-III	5.59	2.01	4.07	3.26	0.15	1.17	25
9	SSW-09, Thingthelh-I	8.32	0.25	4.34	4.24	0.62	1.13	41
10	XPW-10, Thingthelh-II	11.36	0.33	6.24	3.13	0.43	1.15	33
11	XPW-11, Thingthelh-III	14.05	1.18	5.11	4.28	0.34	3.15	41
12	GDW-12, Thingthelh-IV	9.45	1.34	5.32	6.11	0.22	3.14	35
13	SSW-13, N. Thinglian	5.11	1.46	6.34	4.33	0.79	5.14	25
14	SSW-14, Saihapui-I	4.84	0.54	6.17	3.18	0.12	3.01	41
15	XPW-15, Saihapui-II	12.11	2.47	5.11	4.24	0.14	3.02	43
16	GDW-16, N. Thingdawl-I	7.23	0.64	5.18	3.47	0.62	1.44	36
17	GDW-17, N. Thingdawl-II	9.36	1.47	3.19	5.29	0.45	1.16	39
18	GDW-18, N. Thingdawl-III	9.15	2.16	5.46	4.10	0.34	1.12	41
19	SSW-19, N. Thingdawl-IV	5.71	0.79	4.28	5.53	0.21	1.14	42
20	XPW-20, N. Thingdawl-V	8.32	2.47	6.17	3.49	0.79	3.17	37
21	SSW-21, Sethawn-I	11.32	0.64	5.12	3.28	0.12	3.17	44
22	XPW-22, Sethawn-II	14.09	1.45	5.18	4.43	0.37	5.14	43
23	SSW-23, Bukvannei-I	9.45	2.15	3.14	3.18	0.21	3.04	36
24	XPW-24, Bukvannei-II	5.71	2.06	5.44	4.28	0.72	3.02	42
25	XPW-25, Meidum	4.89	0.28	3.19	3.17	0.14	1.04	62
26	XPW-26, S. Chhimluang-I	4.35	0.31	5.47	5.23	0.11	1.15	57
27	XPW-27, S. Chhimluang-II	5.44	1.19	4.28	4.14	0.64	1.13	36
28	SSW-28, N. Chawnpui	8.32	1.37	6.17	5.57	0.43	2.14	64
29	XPW-29, Dilzau-I	4.35	1.42	5.16	5.24	0.31	1.13	40
30	XPW-30, Dilzau-II	5.58	2.14	5.11	4.16	0.61	1.16	43





Malsawmtluanga et al.,



Fig.1. Location of the study area

Fig 2: Different types of water sources SSW, XPW and GDW from where water samples were collected

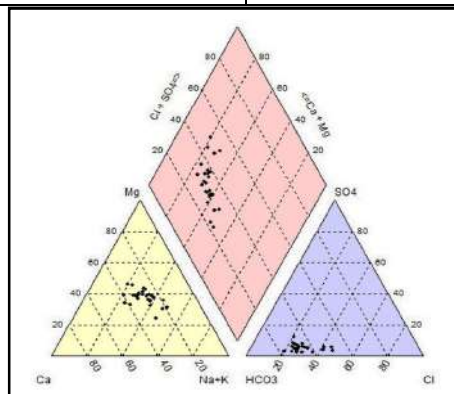


Fig 3: Piper -Trilinear diagram of Groundwater and Sub-Surface water samples by plotting anions and cations





## Effect of Functional Gait Score on Postural Control, Balance and Weight Bearing Symmetry in Recovering Stroke Patients - A Correlation Study

Chaitali Shah<sup>1\*</sup> and R. K.Chavda<sup>2</sup>

<sup>1</sup>Associate Professor, Ph.D Scholar, Parul University, Vadodara, Gujarat, India.

<sup>2</sup>Research Guide, Parul University, Vadodara, Gujarat, India.

Received: 17 Nov 2021

Revised: 21 Dec 2021

Accepted: 10 Jan 2022

### \*Address for Correspondence

**Chaitali Shah**

Associate Professor,  
Ph.D Scholar, Parul University,  
Vadodara, Gujarat, India.



This is an Open Access Journal / article distributed under the terms of the **Creative Commons Attribution License** (CC BY-NC-ND 3.0) which permits unrestricted use, distribution, and reproduction in any medium, provided the original work is properly cited. All rights reserved.

### ABSTRACT

Stroke is neurovascular disease caused by disruption of blood flow to brain, result in neurological deficit. As a consequence of stroke there will be loss of leg strength and impaired balance that may affect walking ability and Functional Gait .Functional Gait affection will also lead to loss of Balance, Postural control and weight bearing symmetry. The study is conducted to find out relationship between Dynamic Gait index score with Postural control, Balance and weight bearing symmetry in recovering stroke patients. Total 36 patients were screened as per inclusion and exclusion criteria. Demographic data was taken. At the time of discharge baseline data was taken. Functional Gait score was recorded with use of DGI, Balance was assessed with BBS and PASS was taken for Postural Control. Weight bearing symmetry was calculated with Use of Weighing Scale. Total 36 Recovering stroke Patients have participated in the study. All the stroke patients who have participated in the study were having mean age of 58 years and participants of both the genders were included .Amongst the participants' males were 63.8% and females were 31.1%. Were included in the study. Participants with both sided strokes were consider for data collection. DGI score has found to have negative correlation with BBS, PASS and Weight Bearing Symmetry. PASS has moderate positive correlation with BBS and weak positive correlation with Weight Bering Symmetry. BBS score has weak positive correlation with weight bearing symmetry. Functional Gait score have not any impact on Postural control, Balance and Weight bearing symmetry but Postural control, balance and weight bearing symmetry are found to have association with each other.

**Keywords:** Functional Gait, Balance, Postural control, Weight bearing symmetry

### INTRODUCTION

Stroke is the sudden loss of neurological function caused by an interruption of the blood flow to the brain [1]. Stroke is most common cause of chronic disability [1]. Clinically, a variety of focal deficits are possible, including changes in



**Chaitali Shah and R.K.Chavda**

the level of consciousness and impairments of sensory, motor, cognitive, perceptual, and language functions [1]. Balance is complex process involving reception and integration of sensory inputs and planning and execution of movement to achieve a goal requiring upright posture. It is ability to control centre of gravity over base of support in given sensory environment [2]. Disturbance in balance after stroke is a major problem which increases level of dependency for activities of daily living and increases risk of falls. [3]Balance impairments often restrict activity levels, produce abnormal compensatory motor behaviour and may require devices for support or assistance from another person. [2]Balance is disturbed in stroke with impairments in steadiness, symmetry and dynamic stability [1]. Stroke related hemiparesis also exhibit asymmetry in standing posture and walking [4][5][6]. This may be due to motor weakness, asymmetric muscular tone and somato sensory deficits in lower extremities which lead to balance impairments, postural sway, disordered gait and increased probability of falls [7][8][9][10]. Weight bearing symmetry is almost equal weight distribution through both lower limbs. Symmetry in posture is an essential component for optimal functioning of any locomotor system [11]. Postural asymmetry is also considered the most common locomotor deficit identified with hemiparesis secondary to stroke [11].

After Stroke, often there is altered weight distribution of lower limbs that is less weight is taken on affected side, less excursion on the weaker side, is seen during static, dynamic and external perturbation [11]. Altered weight distribution of lower limbs that is less weight is taken on affected side, less excursion on the weaker side, is seen during static, dynamic and external perturbation [3]. Postural control involves controlling the body's position in space for the dual purposes of stability and orientation. Postural orientation is defined as the ability to maintain an appropriate relationship between body segments, and between the body and the environment. A number of factors contribute to postural control during quiet stance (so- called static balance), including (a.) body alignment (b.) muscle tone (c.) postural tone. Dynamic Postural control require to stabilize the body when the support surface is moving or when the body is moving on a stable surface such as sit-to-stand transfers or walking. Automatic postural reactions require to maintain balance in response to unexpected external perturbations. Patients with stroke demonstrate increased postural sway in standing [1]. Findings stress important role that body asymmetries play in control of upright posture [12]. However, it is not known whether any relation exists between postural control, weight bearing symmetry and balance in acute stroke survivors so the study is performed to find out relation of Gait Parameters with the Postural control, weight bearing symmetry and Balance.

**Objectives**

1. To find out relation between Functional Gait on postural control in individuals with acute stroke.
2. To find out relation between Functional Gait on Balance in individuals with acute stroke.
3. To find out relation between Functional Gait and weight bearing symmetry in individuals with acute stroke.
4. To find out relation between postural control on Balance in individuals with acute stroke.
5. To find out relation between postural control on weight Bearing Symmetry in individuals with acute stroke.
6. To find out relation between Balance on weight Bearing Symmetry in individuals with acute stroke.

**Hypothesis****Null Hypothesis**

**H<sub>0</sub>:** There will not be significant correlation of Functional Gait with Postural Control, Balance and Weight Bearing symmetry in individuals with acute stroke.

**Alternative (Experimental) Hypothesis**

**H<sub>1</sub>:** There will be significant correlation of Functional Gait with Postural Control, Balance and Weight Bearing symmetry in individuals with acute stroke.

**MATERIAL AND METHODOLOGY****Study Design**

Correlation Study



**Chaitali Shah and R.K.Chavda****Study Setting**

This study was conducted at Physiotherapy Department, Parul Sevashram Hospital, Limda, Waghodiya, Vadodara.

**Sampling and Sample Size**

Selective Sampling technique was used. Individual who suffer from the stroke fulfilling inclusion and exclusion criteria were enrolled in the study. Total 36 Patients were enrolled in the study.

**Study Population**

Post-stroke patients referred for Physiotherapy treatment of PSH Hospital, Vadodara fulfilling the inclusion and exclusion criteria.

**Inclusion Criteria**

Single, acute, unilateral stroke with asymmetry of weight bearing (weight bearing on affected side of less than 35% of total body weight) [12]. Both male and female within age group of 50-70 years [14]. Ability to stand & maintain balance with minimal assists (FIM ambulation score of at least 1) [12]. Able to ambulate at least 50 feet with or without assistive device [14]. Minimum score of 30/56 on Berg Balance Scale [14]. Ability to understand and follow instructions [12]. MMSE score of 24 or more.

**Exclusion Criteria**

Serious or unstable medical conditions [12]. History of other neurological diseases (i.e. chronic stroke, Parkinson's disease, multiple sclerosis) [12]. Other comorbidities [12]. Fixed contracture or deformity [14]. Voluntary control less than 3. Subject was unable to give informed consent.

**Material used in the Study**

- Pencil, pen, sharpener, Eraser, Yardstick.
- Measure tape.
- Examination table.
- Plinth.
- Mat.
- Chairs with and without arm rest.
- Footstool.
- Stopwatch application available in mobile.
- Calculator application available in mobile.
- A wooden block.
- Two weighing scales (12 inches X 12 inches X 0.75 inches).
- Digital camera.
- Assessment charts.
- Recording sheets.
- Berg Balance Scale sheet.
- Postural Assessment Score for Stroke patient's sheet.
- Weight Bearing symmetry score sheet.

**Data collection and methodology**

A written and informed consent about enrolment in the study and maintaining adequate privacy and confidentiality was taken from all patients included in the study. All patients were subjected to a standardized interview including details regarding the event. For example, Time gap between onset of Stroke and start of Medical and Physiotherapy treatment, various Risk factors and Past, Present and Family history related to the present illness. A clinical history and a complete Physical and Functional Physiotherapy examination was done in each case. Patients of Stroke were selected that were diagnosed by physician and referred to Outdoor Physiotherapy Department of Parul Sevashram Hospital, Vadodara. Post-stroke patients fulfilling the inclusion and exclusion criteria were selected and assessed



**Chaitali Shah and R.K.Chavda**

before starting the intervention. Patient's Baseline data were taken and all measures used are valid and shown to have acceptable reliability.

**Dynamic Gait Index:** All participants were assessed for the DGI as part of their initial baseline assessments. The eight item evaluation was administered according to protocol. The assessment was performed in a 20-foot-long marked walking area with use of equipment of a shoebox, two obstacles, and stairs. Depending on the person's ability, all eight tasks were completed in average of 15-20 minutes.

Following task were assessed as Components of DGI

1. steady state walking
2. walking with changing speeds
3. walking with head turns both horizontally and vertically
4. walking while stepping over and around obstacles
5. pivoting while walking and
6. Stair climbing.

Scores were based on a 4-point scale

3 = no gait dysfunction

2 = minimal impairment

1 = moderate impairment and

0 = severe impairment

Maximum possible score was 24 points.

Patient score ranges between 0-24 according to their ability to perform the task of the scale.

**Berg Balance Scale:** The Berg Balance Scale (BBS) is a 14-item scale that quantitatively assesses balance and risk for falls [20]. In most items, the subject is asked to maintain a given position for a specific time. Progressively more points are deducted if

- The time or distance requirements are not met
- The subject's performance warrants supervision
- The subject touches an external support or receives assistance from the examiner.

**Postural Assessment Scale for Stroke Patients:** The postural assessment scale for stroke patients (PASS) is 12-item valid and reliable scale that assesses postural control in stroke patients [15].

**Digital Weighing Scale:** for weight symmetry assessment.[16]

**Data Management and Analyses**

Demographic, data for BBS, PASS and Weight bearing Symmetry were entered into a Microsoft Excel prior to analysis. Statistical analysis was performed in SPSS (version 20). Descriptive analyses were used to present demographic characteristics. Multiple correlation analyses were performed to examine the effect of Functional Gait on Postural control, Balance and Weight bearing symmetry. Pearson correlations were used to check for correlations between Functional gait with PASS, BBS and Weight bearing Symmetry.

**RESULT**

Correlation was calculated on Total 36 Recovering stroke Patients who were recruited for study. Participants had a mean age of 52.65 years, and included both males and females (78.10% male and 21.90% female). Individuals presented with both left (18.70%) and right-sided (81.25%) strokes. Stroke impact scale score was found positively correlated with velocity, and stride length, and negatively with TUG. ( $P = .001$  to  $P = .031$ ). TUG score correlated negatively with Gait Velocity and Stride Length. The data was analysed for Total 36 stroke survivors with Mean Age 58 Years. Out of 36 participants 23 were Male and 13 were Female. The value of R for Correlation between DGI and

37947





**Chaitali Shah and R.K.Chavda**

BBSis -0.0615. The value of R Correlation between DGI and PASSis -0.1179. Which indicates a negative correlation, the relationship between your variables is only weak. For Correlation between DGI and weight bearing symmetry the R value is -0.0226. It suggests negative correlation, the relationship between these variables. The value of R for Correlation between BBS and PASSis 0.6801 indicates a moderate positive correlation. For Correlation between BBS and weight bearing symmetry the value of R is 0.2674. Although technically a positive correlation, the relationship between your variables is weak. Correlation between PASS and weight bearing symmetry the value of R is 0.0064 which suggests a weak positive correlation between variables.

**DISCUSSION**

In this study total 36 stroke survivors were assessed for DGI, BBS, PASS and weight bearing symmetry to observe their association with each other. Negative association was found between Functional gait with Postural control, balance and weight bearing symmetry. Positive association was found between Postural control, Balance and Weight bearing Symmetry. In one of the study it was found that "Training for the Postural control, Balance and Weight symmetry are found to be effective in patients at acute stage then it will aid in early recovery and independence and physiotherapist can use it effectively in acute stroke patients in physiotherapy setups and community based rehabilitation to improve functioning in activities of daily living" which indicates that Postural control, Balance and Weight bearing symmetry are interrelated with each other and improvement of one will produce improvement in other. Jonsdottir and Cattaneo [17]. "Dynamic balance is multidimensional and previous studies have suggested the lack of perfect correlations may indicate that each test measures different aspects of balance". The clinical tools use to assess the balance may not provide proper understanding for the mechanisms responsible for dynamic balance or the factors which may contribute to loss of balance. It may be one of the reasons for negative correlation between DGI and BBS.

As per one of the study "The clinical balance scores are analogous to walking speed, which is a global indicator of gait dysfunction, but it does not identify potential contributing factors" which may produce less reduction in DGI score in presence of affected balance and Postural control. Mansfield et al. [18] observed a significant association of greater WBA with poorer BBS scores. In healthy people, adopting an asymmetric weight distribution results in increased regulatory activity (i.e., COP velocities) under the most loaded leg, thereby increasing its relative contribution to postural control [19]. In the studies by Roerdink et al. [20] and van Asseldonk et al. [21] the regulatory activity under the paretic leg was found to be substantially lower compared to the non-paretic leg. In one of the study it was observed that "Overall, the muscular responses of the patients were delayed compared to the healthy controls. These findings suggest that WBA is not the primary cause of the reduced postural stability after stroke." [22]. The study by Pereira et al. (2010) was the only one that reported greater WBA to be associated with better postural stability as measured with the Functional Reach test, but this only concerned the individuals bearing more weight on the non-paretic leg [23].

**CONCLUSION**

Functional Gait score have not any impact on Postural control, Balance and Weight bearing symmetry but Postural control, balance and weight bearing symmetry are found to have association with each other means stroke will lead to affected Postural control which results in balance problem. Asymmetry in weight bearing will also lead to affection of Postural control and Balance.

**Limitation of Study**

- Small sample size
- Results of males and females cannot be compared because of fewer female patients as compared to male patients.
- Division of patients according to age group was not done in the study.





**Chaitali Shah and R.K.Chavda**

## REFERENCES

1. Susan B O'Sullivan, Thomas J Schmitz, "Physical Rehabilitation", 5<sup>th</sup> Ed.; 2007: Jaypee: 705-769.
2. Darcy A. Umphred, "Umphred's Neurological Rehabilitation", 6<sup>th</sup> Ed.; 2013: Mosby: 653-710.
3. Sarah F Tyson, Marie Hanley, Jay Chillala, Andrea Selley, Raymond C Tallis, "Balance Disability After Stroke", Physical Therapy January 2006vol. 86 no. 1 30-38.
4. Janice J. Eng, PhD, PT/OT, Kelly S. Chu, MSc, "Reliability and comparison of weight-bearing ability during standing tasks for individuals with chronic stroke", Archives of Physical Medicine and Rehabilitation, Volume 83, Issue 8, August 2002, Pages 1138–1144.
5. Gianna M. Rodriguez, MD, Alexander S. Aruin, PhD, "The effect of shoe wedges and lifts on symmetry of stance and weight bearing in hemiparetic individuals", Rehabilitation, Volume, April 2002, Pages 478–482.
6. Wall JC, Turnbull GI, "Gait asymmetries in residual hemiplegia", Archives of Physical Medicine and Rehabilitation [1986, 67(8):550-553].
7. Nicolas Genthon, PAnne-Sophie Gissot, Jérôme Froger, Patrice Rougier, Dominic Pérennou, "Posturography in Patients With Stroke: Estimating the Percentage of Body Weight on Each Foot From a Single Force Platform", Stroke.2008; 39: 489, doi: 10.1161/STROKEAHA.107.493478.
8. J F Marsden, D E Playford, B L Day, "The vestibular control of balance after stroke", Journal of Neurology Neurosurgery Psychiatry; 2005; 76:670-679; doi:10.1136/jnnp.2004.046565.
9. Perrennou D. "Weight bearing asymmetry in standing hemiparetic patients". A Journal of neurology, neurosurgery and psychiatry 2005; 76(5)621-622.
10. Pao-Tsai Cheng, Mei-Yun Liaw, May-Kuen Wong, Fuk-Tan Tang, Ming-Yih Lee, Pay-Shin Lin, "The sit-to-stand movement in stroke patients and its correlation with falling", Rehabilitation, Volume, September 1998, Pages 1043–1046.
11. Catherine M. Sackley, Falls, sway, and symmetry of weight-bearing after stroke, International Disability Studies, 13:1, 1-4, DOI: 10.3109/03790799109166267.
12. Sambit Mohapatra, Aileen C. Eviota, Keir L. Ringquist, Sri Ranjini Muthukrishnan, Alexander S. Aruin, "Compelled Body Weight Shift Technique to Facilitate Rehabilitation of Individuals with Acute Stroke", ISRN Rehabilitation, Volume 2012 (2012), Article ID 328018.
13. Alexander S. Aruin, "The effect of asymmetry of posture on anticipatory postural adjustments", Neuroscience Letters Volume 401, Issues 1–2, 19 June 2006, Pages 150–153.
14. JebaChitra, Siddharth Mishra, "effect of compelled body weight shift therapy on weight bearing symmetry and balance in post stroke patients: an experimental pre-post study", International Journal of Physiotherapy and Research, Int J Physiother Res 2014, Vol 2(6):781-86. ISSN 2321-1822 DOI: 10.16965/ijpr.2014.687.
15. The WHO STEP wise approach to stroke Surveillance. World Health Organization 2005.
16. Ralph L. Sacco, Scott E. Kasner, Joseph P. Broderick. "An Updated Definition of Stroke for the 21st Century" American Heart Association. 2013.
17. Jonsdottir J, Cattaneo D. Reliability and validity of the dynamic gait index in persons with chronic stroke. Archives of physical medicine and rehabilitation. 2007 Nov 1;88(11):1410-5.
18. A. Mansfield, G. Mochizuki, E. L. Inness, and W. E. McIlroy, "Clinical correlates of between-limb synchronization of standing balance control and falls during inpatient stroke rehabilitation," *Neurorehabilitation and Neural Repair*, vol. 26, no. 6, pp. 627–635, 2012.
19. L. C. Anker, V. Weerdesteyn, I. J. W. van Nes, B. Nienhuis, H. Straatman, and A. C. H. Geurts, "The relation between postural stability and weight distribution in healthy subjects," *Gait and Posture*, vol. 27, no. 3, pp. 471–477, 2008.
20. M. Roerdink, A. C. H. Geurts, M. De Haart, and P. J. Beek, "On the relative contribution of the paretic leg to the control of posture after stroke," *Neurorehabilitation and Neural Repair*, vol. 23, no. 3, pp. 267–274, 2009.
21. E. H. F. van Asseldonk, J. H. Buurke, B. R. Bloem et al., "Disentangling the contribution of the paretic and non-paretic ankle to balance control in stroke patients," *Experimental Neurology*, vol. 201, no. 2, pp. 441–451, 2006.





**Chaitali Shah and R.K.Chavda**

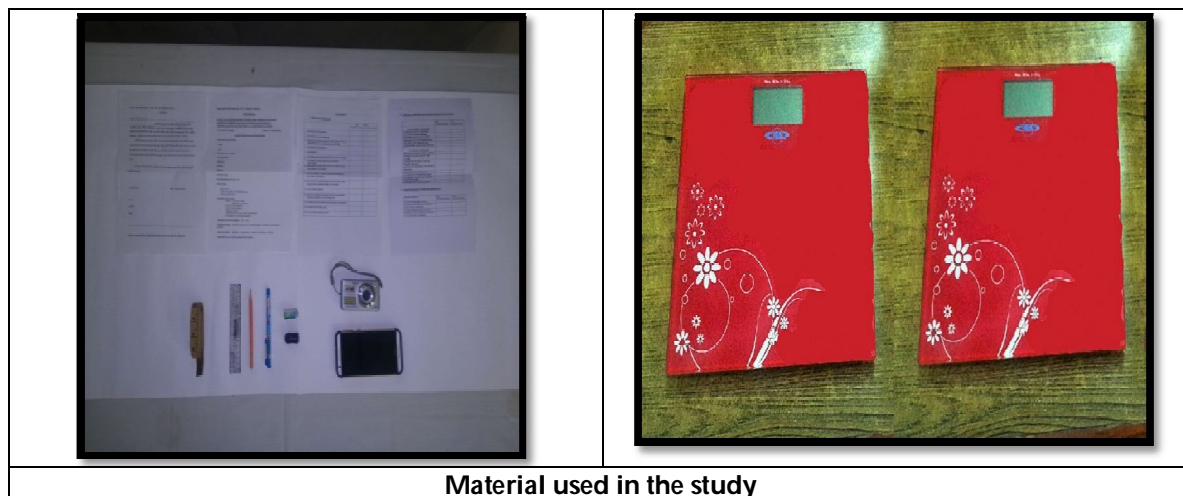
22. Jip F. Kamphuis, Digna de Kam, Alexander C. H. Geurts, Vivian Weerdesteyn, "Is Weight-Bearing Asymmetry Associated with Postural Instability after Stroke? A Systematic Review", *Stroke Research and Treatment*, vol. 2013, Article ID 692137, 13 pages, 2013. <https://doi.org/10.1155/2013/692137>
23. L. C. Pereira, A. C. Botelho, and E. F. Martins, "Relationships between body symmetry during weight-bearing and functional reach among chronic hemiparetic patients," *Revista Brasileira de Fisioterapia*, vol. 14, no. 3, pp. 259–266, 2010.

**Table 1: Participant’s Characteristics**

Participant’s Characteristics	Mean	SD
Age	58	7.72
Male	63.8%	-
Female	36.1%	
MMSE score	28.1	0.87
DGI	17.02	2.73
BBS	37.6	4.83
PASS	27.7	1.88
Weight Bearing Symmetry	27.9	6.22

**Table 2: Correlation between Dynamic Gait Index, PASS, BBS and Weight Bearing Symmetry**

		DGI	PASS	BBS	Weight Bearing Symmetry
DGI	Pearson Correlation	1	-0.1179.	-0.0615	-0.0226.
	Sig. (2-tailed)	.	.1179	.0615	.0226.
	N	36	36	36	36
PASS	Pearson Correlation	-0.1179.	1	0.6801	0.0064.
	Sig. (2-tailed)	.1179	.	.6801	.0064
	N	36	36	36	36
BBS	Pearson Correlation	-0.0615	0.6801	1	0.2674.
	Sig. (2-tailed)	.0615	.6801	.	.2674.
	N	36	36	36	36
Weight Bearing Symmetry	Pearson Correlation	-0.0226.	0.0064.	0.2674.	1
	Sig. (2-tailed)	.0226.	.0064	.2674.	.
	N	36	36	36	36

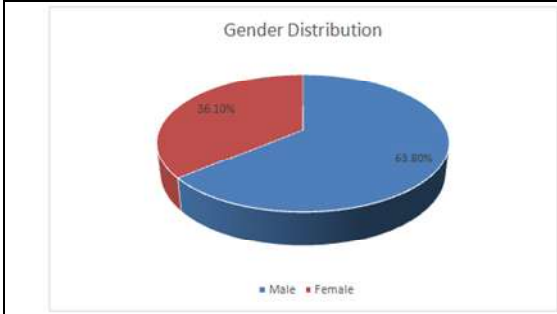


**Material used in the study**

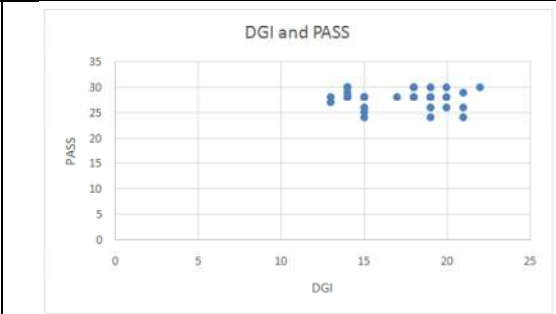




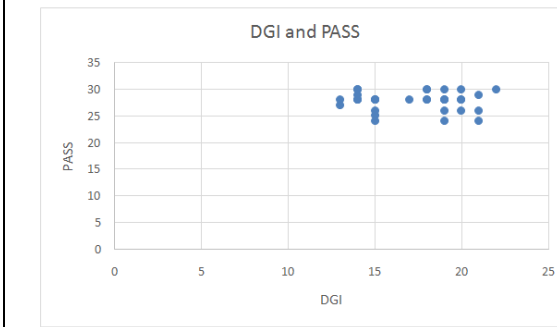
**Chaitali Shah and R.K.Chavda**



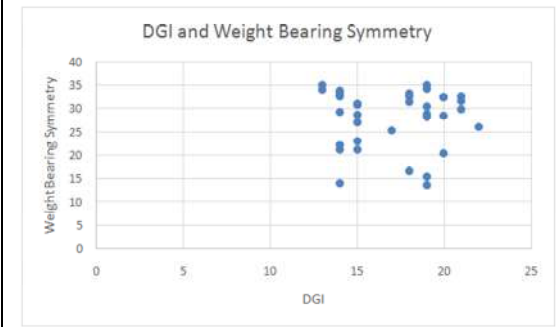
**Graph-1 Gender Distribution**



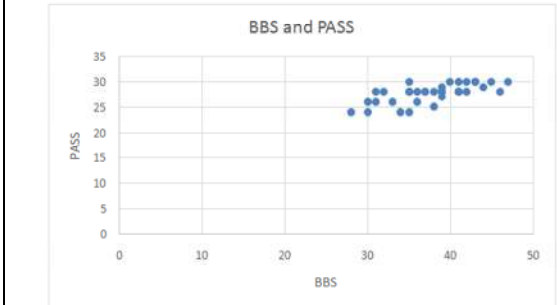
**Graph-2 Correlation between DGI and BBS**



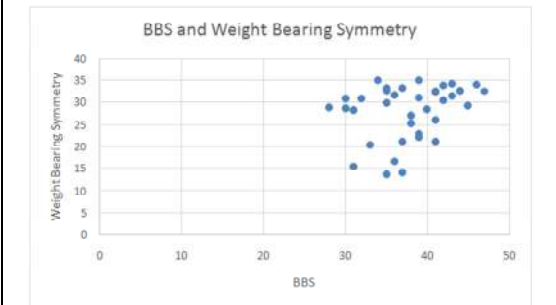
**Graph-3 Correlation between DGI and PASS**



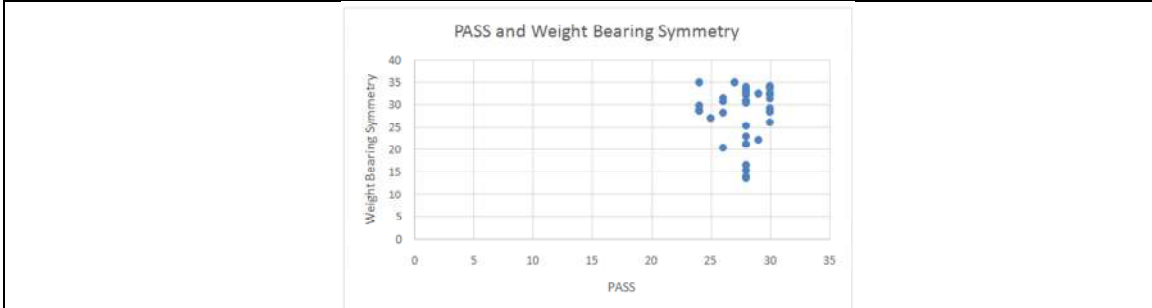
**Graph-4 Correlation between DGI and Weight Bearing Symmetry**



**Graph-5 Correlation between BBS and PASS**



**Graph-6 Correlation between BBS and Weight Bearing Symmetry**



**Graph-7 Correlation between PASS and Weight Bearing Symmetry**





## RESEARCH ARTICLE

## A New Approach to Some Properties of $(1,2)^*$ - $\widehat{D}$ -Closed Sets in Bitopological Spaces

A.Saranya<sup>1\*</sup>, H. Gowri<sup>2</sup>, C. Shanmuga Vadivu<sup>3</sup> and A. Pandi<sup>4</sup>,

<sup>1</sup>Assistant Professor, Department of Mathematics, Sri Adi Chunchanagiri Women's College, Cumbum, Theni, Tamil Nadu, India.

<sup>2</sup>Assistant Professor, Department of Mathematics, Bharathiar University PG Extension and Research Centre, Palaniswamy College of Arts Campus, Perundurai, Erode – 638052, Tamil Nadu, India.

<sup>3</sup>Assistant Professor and Head, PG and Research Department of Mathematics, Sethupathy Govt. Arts College, Ramanathapuram – 623502, Tamil Nadu, India.

<sup>4</sup>Assistant Professor, Department of Mathematics, Rathinam Technical Campus, Coimbatore – 21, Tamil Nadu, India.

Received: 01 Dec 2021

Revised: 20 Dec 2021

Accepted: 12 Jan 2022

### \*Address for Correspondence

#### A.Saranya

Assistant Professor,  
Department of Mathematics,  
Sri Adi Chunchanagiri Women's College,  
Cumbum, Theni, Tamil Nadu, India.  
Email:



This is an Open Access Journal / article distributed under the terms of the **Creative Commons Attribution License** (CC BY-NC-ND 3.0) which permits unrestricted use, distribution, and reproduction in any medium, provided the original work is properly cited. All rights reserved.

### ABSTRACT

In the paper, we introduce a new approach to some properties of  $(1,2)^*$ - $\widehat{D}$ -closed sets and  $(1,2)^*$ -D-closed sets in bitopological spaces.

**2010 Mathematics Subject Classification:** 54E55

**Keywords:**  $(1,2)^*$ - $\widehat{D}$ -closed,  $(1,2)^*$ -D-closed,  $(1,2)^*$ - $\widehat{D}$ -interior,  $(1,2)^*$ - $\widehat{D}$ -closure.

## INTRODUCTION

J. C. Kelly [3], introduced the bitopological spaces and K. Dass and G. Suresh [2], introduced the  $\widehat{D}$ -closed sets in topological spaces. The study of generalized closed sets in a topological space was initiated by Levine [4]. In 2012, J. Antony Rex Rodrigo and K. Dass [1], introduced the concept of D-closed sets and their properties. M. Meharin, et. al. [5], some contributions of  $(1,2)^*$ - $\widehat{D}$ -closed sets in bitopological spaces. In the paper, we introduce a new approach to some properties of  $(1,2)^*$ - $\widehat{D}$ -closed sets and  $(1,2)^*$ -D-closed sets in bitopological spaces.





Saranya et al.,

## PRELIMINARIES

Throughout this paper  $(X, \tau_{1,2})$  or  $X$  will always denote bitopological spaces. Let  $A$  be a subset of  $X$ .  $\tau_{1,2}\text{-cl}(A)$  and  $\tau_{1,2}\text{-int}(A)$  denote the  $\tau_{1,2}$ -closure and  $\tau_{1,2}$ -interior set of  $A$  respectively. We recall some known definitions are needed in the paper.

### Definition 2.1

Let  $A$  be a subset of  $X$ . Then  $A$  is said to be  $\tau_{1,2}$ -open [7] if  $H = P \cup Q$ , where  $P \in \tau_1$  and  $Q \in \tau_2$ .

The complement of  $\tau_{1,2}$ -open set is called  $\tau_{1,2}$ -closed.

Notice that  $\tau_{1,2}$ -open sets need not necessarily form a topology.

**Definition 2.2** [8] Let  $A$  be a subset of  $X$ . Then

- (i) the  $\tau_{1,2}$ -closure of  $A$ , denoted by  $\tau_{1,2}\text{-cl}(A)$ , is defined as  $\bigcap \{F : A \subseteq F \text{ and } F \text{ is } \tau_{1,2}\text{-closed}\}$ .
- (ii) the  $\tau_{1,2}$ -interior of  $A$ , denoted by  $\tau_{1,2}\text{-int}(A)$ , is defined as  $\bigcup \{F : F \subseteq A \text{ and } F \text{ is } \tau_{1,2}\text{-open}\}$ .

**Definition 2.3** A subset  $A$  of  $X$ , is called

- (i)  $(1,2)^*$ -semi-open [6] if  $A \subseteq \tau_{1,2}\text{-cl}(\tau_{1,2}\text{-int}(A))$ ;

The complement of the  $(1,2)^*$ -semi-open set is called  $(1,2)^*$ -semi-closed set.

- (ii)  $(1,2)^*$ -semi-pre-open [6] ( $(1,2)^*$ - $\beta$ -open) if  $A \subseteq \tau_{1,2}\text{-cl}(\tau_{1,2}\text{-int}(\tau_{1,2}\text{-cl}(A)))$ ;

The complement of the  $(1,2)^*$ -semi-pre-open set is called  $(1,2)^*$ -semi-pre-closed set.

The  $(1,2)^*$ -semi-pre-closure of the set  $A$  is defined as the intersection of all  $(1,2)^*$ -semi-pre-closed sets containing in  $A$  and is denoted by  $(1,2)^*\text{-spcl}(A)$ .

**Definition 2.4** A subset  $A$  of  $X$ , is called  $(1,2)^*$ - $\omega$ -closed [9] ( $(1,2)^*$ - $\hat{g}$ -closed) if  $\tau_{1,2}\text{-cl}(A) \subseteq U$  whenever  $A \subseteq U$  and  $U$  is  $(1,2)^*$ -semi-open;

The complement of the  $(1,2)^*$ - $\omega$ -closed set is called  $(1,2)^*$ - $\omega$ -open set.

**Definition 2.5**[5] A subset  $A$  of  $X$  is called a

- (i)  $(1,2)^*$ -D-closed if  $(1,2)^*\text{-scl}(A) \subseteq \tau_{1,2}\text{-int}(U)$  whenever  $A \subseteq U$  and  $U$  is  $(1,2)^*$ - $\omega$ -open.

The complement of the  $(1,2)^*$ -D-closed set is called  $(1,2)^*$ -D-open set.

- (ii)  $(1,2)^*$ - $\hat{D}$ -closed if  $(1,2)^*\text{-spcl}(A) \subseteq U$  whenever  $A \subseteq U$  and  $U$  is  $(1,2)^*$ -D-open.

The complement of the  $(1,2)^*$ - $\hat{D}$ -closed set is called  $(1,2)^*$ - $\hat{D}$ -open set.

The class of all  $(1,2)^*$ - $\hat{D}$ -cld in  $X$  is denoted by  $(1,2)^*\text{-}\hat{D}C$ .

## PROPERTIES OF $(1,2)^*\text{-}\hat{D}$ -CLOSED SETS IN BITOPOLOGICAL SPACES

**Proposition 3.1** If  $A$  and  $B$  are  $(1,2)^*\text{-}\hat{D}$ -closed, then  $A \cap B$  is  $(1,2)^*\text{-}\hat{D}$ -closed.

**Proof.** Let  $U$  be a  $(1,2)^*$ -D-open set and  $A \cap B \subseteq U$ . Let  $A$  and  $B$  are  $(1,2)^*\text{-}\hat{D}$ -closed set. Then  $(1,2)^*\text{-spcl}(A) \subseteq U$  and  $(1,2)^*\text{-spcl}(B) \subseteq U$ . Since  $A \subseteq U$ ,  $B \subseteq U$  then  $A \cap B \subseteq U$ . Hence  $(1,2)^*\text{-spcl}(A \cap B) = (1,2)^*\text{-spcl}(A) \cap (1,2)^*\text{-spcl}(B) \subseteq U$ . Therefore  $A \cap B$  is  $(1,2)^*\text{-}\hat{D}$ -closed set.

**Remark 3.2** The union of any two  $(1,2)^*\text{-}\hat{D}$ -closed need not be  $(1,2)^*\text{-}\hat{D}$ -closed.





**Saranya et al.,**

**Example 3.3** Let  $X=\{a,b,c\}$  with  $\tau_1=\{\phi,\{a\},X\}$  and  $\tau_2=\{\phi,\{b\},X\}$ . Then  $\tau_{1,2}=\{\phi,\{a\},\{b\},\{a,b\},X\}$ . Here,  $A=\{a\}$  and  $B=\{b\}$  are  $(1,2)^*\widehat{D}$ -closed but  $\{a\}\cup\{b\}=\{a,b\}$  is not  $(1,2)^*\widehat{D}$ -closed.

**Proposition 3.4** Let  $A$  be an  $(1,2)^*\widehat{D}$ -closed set in  $X$ . Then  $(1,2)^*\text{-spcl}(A)-A$  does not contain any non empty  $(1,2)^*\text{-D}$ -closed set.

**Proof.** Suppose that  $A$  be an  $(1,2)^*\widehat{D}$ -closed and let  $F$  be an  $(1,2)^*\text{-D}$ -closed set with  $F \subseteq (1,2)^*\text{-spcl}(A)-A$ . Then  $A \subseteq F^c$  and so  $(1,2)^*\text{-spcl}(A) \subseteq F^c$ . Hence  $F \subseteq ((1,2)^*\text{-spcl}(A))^c$ . Thus  $F \subseteq (1,2)^*\text{-spcl}(A) \cap ((1,2)^*\text{-spcl}(A))^c = \emptyset$ .

**Remark 3.5** The converse of the above theorem need not be true as seen from the following example.

**Example 3.6** Let  $X=\{a,b,c,d,e\}$  with  $\tau_1=\{\phi,\{a\},\{a,b\},X\}$  and  $\tau_2=\{\phi,\{c,d\},X\}$ . Then  $\tau_{1,2}=\{\phi,\{a\},\{a,b\},\{c,d\},\{a,c,d\},\{a,b,c,d\},X\}$ . Here,  $A=\{a,d\}$ . Then  $(1,2)^*\text{-spcl}(A)-A=\{a,b,d\}-\{a,d\}=\{b\}$  does not contain non empty  $(1,2)^*\text{-D}$ -closed set but  $A=\{a,d\}$  is not  $(1,2)^*\widehat{D}$ -closed.

**Proposition 3.7** Let  $A$  and  $B$  be any two subsets of a space  $X$ . If  $A$  is  $(1,2)^*\widehat{D}$ -closed such that  $A \subseteq B \subseteq (1,2)^*\text{-spcl}(A)$ , then  $B$  is  $(1,2)^*\widehat{D}$ -closed.

**Proof.** Let  $U$  be an  $(1,2)^*\text{-D}$ -open set of  $X$ , such that  $B \subseteq U$ . Then  $A \subseteq U$ ,  $A$  is  $(1,2)^*\widehat{D}$ -closed we get  $(1,2)^*\text{-spcl}(A) \subseteq U$ . Now  $(1,2)^*\text{-spcl}(B) \subseteq (1,2)^*\text{-spcl}((1,2)^*\text{-spcl}(A)) = (1,2)^*\text{-spcl}(A) \subseteq U$ . Thus  $B$  is  $(1,2)^*\widehat{D}$ -closed.

**Example 3.8** Let  $X=\{a,b,c,d\}$  and  $\tau_1=\{\phi,\{a\},\{a,b\},X\}$ ,  $\tau_2=\{\phi,\{c,d\},X\}$  with  $\tau_{1,2}=\{\phi,\{a\},\{a,b\},\{c,d\},\{a,c,d\},X\}$ . Here,  $A=\{b\}$  and  $B=\{a,b\}$ . Then  $A$  and  $B$  are  $(1,2)^*\widehat{D}$ -closed sets in  $X$ , but  $B$  is not a subset of  $(1,2)^*\text{-spcl}(A)$ .

**Proposition 3.9** If  $A$  be an  $(1,2)^*\text{-D}$ -open and  $(1,2)^*\widehat{D}$ -closed, then  $A$  is  $(1,2)^*\text{-semi-preclosed}$ .

**Proof.** Since  $A \subseteq A$  and  $A$  be an  $(1,2)^*\text{-D}$ -open and  $(1,2)^*\widehat{D}$ -closed. We get  $(1,2)^*\text{-spcl}(A) \subseteq A$ . But  $A \subseteq (1,2)^*\text{-spcl}(A)$ . Thus  $A$  is  $(1,2)^*\text{-semi-preclosed}$ .

**Proposition 3.10** For each  $x \in X$ , either  $\{x\}$  is  $(1,2)^*\widehat{D}$ -closed or  $\{x\}^c$  is  $(1,2)^*\widehat{D}$ -closed in  $X$ .

**Proof.** Suppose that  $\{x\}$  is not  $(1,2)^*\text{-D}$ -closed in  $X$ . Then  $\{x\}^c$  is not  $(1,2)^*\text{-D}$ -open and the only  $(1,2)^*\text{-D}$ -open set containing  $\{x\}^c$  is the space  $X$  itself. Therefore  $(1,2)^*\text{-spcl}(\{x\}^c) \subseteq X$  and so  $\{x\}^c$  is  $(1,2)^*\widehat{D}$ -closed in  $X$ .

**Proposition 3.11** If a subset  $A$  of  $X$  is  $(1,2)^*\widehat{D}$ -closed, then  $(1,2)^*\widehat{D}\text{-cl}(\{x\}) \cap A \neq \emptyset$  for each  $x \in (1,2)^*\text{-spcl}(A)$ .

**Proof.** Suppose  $x \in (1,2)^*\text{-spcl}(A)$  and  $(1,2)^*\widehat{D}\text{-cl}(\{x\}) \cap A = \emptyset$ . Then  $A \subseteq ((1,2)^*\widehat{D}\text{-cl}(\{x\}))^c$  and  $((1,2)^*\widehat{D}\text{-cl}(\{x\}))^c$  is  $(1,2)^*\text{-D}$ -open. By assumption,  $(1,2)^*\text{-spcl}(A) \subseteq ((1,2)^*\widehat{D}\text{-cl}(\{x\}))^c$  which is contradiction to  $x \in (1,2)^*\text{-spcl}(A)$ .

**Definition 3.12** For every set  $E \subseteq X$  we define the  $(1,2)^*\widehat{D}$ -closure of  $E$  to be the intersection of all  $(1,2)^*\widehat{D}$ -closed sets containing  $E$ . In symbols,  $(1,2)^*\widehat{D}\text{-cl}(E) = \cap\{A: E \subseteq A, A \in (1,2)^*\widehat{D}\text{-C}(X)\}$ .

**Definition 3.13** A subset  $A$  in  $X$  is called  $(1,2)^*\widehat{D}$ -open in  $X$  if  $A^c$  is  $(1,2)^*\widehat{D}$ -closed in  $X$ . We denote the family of all  $(1,2)^*\widehat{D}$ -open sets in  $X$  by  $(1,2)^*\widehat{D}\text{O}(X)$ .

**Theorem 3.14** A subset  $A$  of a bitopological space  $X$  is said to be  $(1,2)^*\widehat{D}$ -open if and only if  $F \subseteq (1,2)^*\text{-spint}(A)$  whenever  $A \subseteq F$  and  $F$  is  $(1,2)^*\text{-D}$ -closed in  $X$ .

**Proof.** Suppose  $A$  is  $(1,2)^*\widehat{D}$ -open in  $X$  and  $A \subseteq F$  and  $F$  is  $(1,2)^*\text{-D}$ -closed in  $X$ . Then  $A^c \subseteq F^c$ , Where  $F^c$  is  $(1,2)^*\text{-D}$ -open in  $X$ . Hence, we get  $(1,2)^*\text{-spcl}(A^c) \subseteq F^c$ , implies  $((1,2)^*\text{-spcl}(A))^c \subseteq F^c$ . Thus we have  $F \subseteq (1,2)^*\text{-spint}(A)$ .

Conversely, Suppose that  $A^c \subseteq U$  and  $U$  is  $(1,2)^*\text{-D}$ -open in  $X$ . Then  $A \supseteq U^c$  and  $U^c$  is  $(1,2)^*\text{-D}$ -closed and by hypothesis  $(1,2)^*\text{-spint}(A) \supseteq U^c$  implies  $((1,2)^*\text{-spint}(A))^c \subseteq U$ . Hence  $(1,2)^*\text{-spcl}(A^c) \subseteq U$  implies that  $A^c$  is  $(1,2)^*\widehat{D}$ -closed in  $X$ . Therefore,  $A$  is  $(1,2)^*\widehat{D}$ -open in  $X$ .

**Proposition 3.15** If  $(1,2)^*\text{-spint}(A) \subseteq B \subseteq A$  and if  $A$  is  $(1,2)^*\widehat{D}$ -open, then  $B$  is  $(1,2)^*\widehat{D}$ -open.





Saranya et al.,

**Proof.** Suppose  $(1,2)^*\text{-spint}(A) \subseteq B \subseteq A$  and  $A$  is  $(1,2)^*\widehat{D}$ -open. Then  $A^c \subseteq B^c \subseteq (1,2)^*\text{-spcl}(A^c)$  and since  $A^c$  is  $(1,2)^*\widehat{D}$ -closed. We have  $B^c$  is  $(1,2)^*\widehat{D}$ -closed. Hence  $B$  is  $(1,2)^*\widehat{D}$ -open.

**Proposition 3.16** If a set  $A$  is  $(1,2)^*\widehat{D}$ -closed, then  $(1,2)^*\text{-spcl}(A)-A$  is  $(1,2)^*\widehat{D}$ -open.

**Proof.** Suppose  $A$  is  $(1,2)^*\widehat{D}$ -closed. Let  $F \subseteq (1,2)^*\text{-spcl}(A)-A$  where  $F$  is  $(1,2)^*\widehat{D}$ -closed. Therefore  $F \subseteq (1,2)^*\text{-spint}((1,2)^*\text{-spcl}(A)-A)$  and we have  $(1,2)^*\text{-spcl}(A)-A$  is  $(1,2)^*\widehat{D}$ -open.

The converse of proposition 3.16 is not true by the following example.

**Example 3.17** Let  $X = \{a, b, c, d, e\}$  with  $\tau_1 = \{\emptyset, \{a\}, \{a, b\}, X\}$  and  $\tau_2 = \{\emptyset, \{c, d\}, X\}$ . Then  $\tau_{1,2} = \{\emptyset, \{a\}, \{a, b\}, \{c, d\}, \{a, c, d\}, \{a, b, c, d\}, X\}$ . Let  $A = \{a, d\}$ ;  $(1,2)^*\text{-spcl}(A)-A = \{a, b, d\} - \{a, d\} = \{b\}$  is  $(1,2)^*\widehat{D}$ -open but  $A$  is not  $(1,2)^*\widehat{D}$ -closed.

**Proposition 3.18** Let  $A$  be subset of a bitopological space  $X$ . For any  $x \in X$ ,  $x \in (1,2)^*\widehat{D}\text{-cl}(A)$  if and only if  $U \cap A \neq \emptyset$  for every  $(1,2)^*\widehat{D}$ -open set  $U$  containing  $x$ .

**Proof. Necessity:** Suppose that  $x \in (1,2)^*\widehat{D}\text{-cl}(A)$ . Let  $U$  be an  $(1,2)^*\widehat{D}$ -open set containing  $x$  such that  $A \cap U = \emptyset$  and so  $A \subseteq U^c$ . But  $U^c$  is  $(1,2)^*\widehat{D}$ -closed and hence  $(1,2)^*\widehat{D}\text{-cl}(A) \subseteq U^c$ . Since  $x \notin (1,2)^*\widehat{D}\text{-cl}(A)$  which is contrary to the hypothesis. Therefore,  $U \cap A \neq \emptyset$  for every  $(1,2)^*\widehat{D}$ -open set  $U$  containing  $x$ .

**Sufficiency:** Suppose that every  $(1,2)^*\widehat{D}$ -open set of  $X$  containing  $x$  such that  $U \cap A = \emptyset$ . If  $x \notin (1,2)^*\widehat{D}\text{-cl}(A)$  then there exist an  $(1,2)^*\widehat{D}$ -closed set  $F$  of  $X$  such that  $A \subseteq F$  and  $x \notin F$ . Therefore,  $x \in F^c$  and  $F^c$  is an  $(1,2)^*\widehat{D}$ -open set containing  $x$ . But  $F^c \cap A = \emptyset$ . Which is contradiction to the hypothesis. Therefore  $x \in (1,2)^*\widehat{D}\text{-cl}(A)$ .

**Definition 3.18** For any  $A \subseteq X$ ,  $(1,2)^*\widehat{D}\text{-int}(A)$  is defined as the union of all  $(1,2)^*\widehat{D}$ -open sets contained in  $A$ . That is  $(1,2)^*\widehat{D}\text{-int}(A) = \cup\{U : U \subseteq A \text{ and } U \in (1,2)^*\widehat{D}\mathcal{O}(X)\}$ .

**Proposition 3.19** Let  $A$  be a subset of a bitopological space  $X$ , Then the following are true

1.  $((1,2)^*\widehat{D}\text{-int}(A))^c = (1,2)^*\widehat{D}\text{-cl}(A^c)$
2.  $(1,2)^*\widehat{D}\text{-int}(A) = ((1,2)^*\widehat{D}\text{-cl}(A^c))^c$
3.  $(1,2)^*\widehat{D}\text{-cl}(A) = ((1,2)^*\widehat{D}\text{-int}(A^c))^c$

**Proof.** (i) Let  $x \in ((1,2)^*\widehat{D}\text{-int}(A))^c$ . Then  $x \notin (1,2)^*\widehat{D}\text{-int}(A)$ . That is, every  $(1,2)^*\widehat{D}$ -open set  $U$  containing  $x$  is such that  $U \not\subseteq A$ . Thus every  $(1,2)^*\widehat{D}$ -open set  $U$  containing  $x$  is such that  $U \cap A^c \neq \emptyset$ . We have  $x \in (1,2)^*\widehat{D}\text{-cl}(A^c)$  and therefore,  $((1,2)^*\widehat{D}\text{-int}(A))^c \subseteq (1,2)^*\widehat{D}\text{-cl}(A^c)$ .

Conversely, let  $x \in (1,2)^*\widehat{D}\text{-cl}(A^c)$ . Then every  $(1,2)^*\widehat{D}$ -open set  $U$  containing  $x$  is such that  $U \cap A^c \neq \emptyset$ . We have  $x \notin (1,2)^*\widehat{D}\text{-int}(A)$ , hence  $x \in ((1,2)^*\widehat{D}\text{-int}(A^c))^c$  and so  $(1,2)^*\widehat{D}\text{-cl}(A^c) \subseteq ((1,2)^*\widehat{D}\text{-int}(A))^c$ . Thus,  $((1,2)^*\widehat{D}\text{-int}(A^c))^c = (1,2)^*\widehat{D}\text{-cl}(A^c)$

(ii) Follows by taking complements in (i)

(iii) Follows by replacing  $A$  by  $A^c$  in (i).

## REFERENCES

1. Antony Rex Rodrigo, J., and Dass, K.: A New type of generalized closed sets, IJMA, 3(4)(2012), 1517-1523.
2. Dass, K., and Suresh, G.:  $\widehat{D}$ -closed sets in topological spaces, Malaya Journal of Matematik, 5(1) (2021), 265-269.
3. Kelly, J.C. : Bitopological spaces, Proc.London Math.Soc., 3(13)(1963), 71-89.
4. Levine, N.: generalized closed sets in topology, Rend. Circ. Mat. Palermo, 19(1970), 89-96.
5. Meharin, M., Siva Subramania Raja, T., Chitra, R., and Pandi, A.: Some contributions of  $(1,2)^*\widehat{D}$ -closed sets in bitopological spaces, Indian Journal of Natural Sciences, 12(69) (2021) (Accepted).
6. Ravi, O. and Lellis Thivagar, M.: A bitopological  $(1,2)^*$ -semi-generalized continuous maps, Bull. Malays. Math. Sci. Soc., (2), 29(1) (2006), 79-88.







**Saranya et al.,**

7. Ravi, O. and Lellis Thivagar, M.: On stronger forms of  $(1,2)^*$ -quotient mappings in bitopological spaces, Internat. J. Math. Game Theory and Algebra., 14(6) (2004), 481-492.
8. Ravi, O. and Thivagar, M. L.: Remarks on  $\lambda$ -irresolute functions via  $(1,2)^*$ -sets, Advances in App. Math. Analysis, 5(1) (2010), 1-15.
9. Ravi, O., Pandi, A., Pious Missier, S. and Salai Parkunan, T.: Remarks on bitopological  $(1,2)^*$ - $\tau\omega$ -Homeomorphisms, International Journal of Mathematical Archive, 2(4) (2011), 465-475.





## Internet Addiction among School Students in Karaikal: An Explorative Study

Venkatesan M P<sup>1\*</sup> and K.Kamala<sup>2</sup>

<sup>1</sup>Ph.D Scholar, Vinayaka Mission's College of Nursing, Karaikal, Puducherry (U.T), Vinayaka Mission's Research Foundation(DU)-Salem,Tamil Nadu, India.

<sup>2</sup>Guide, Vinayaka Mission's College of Nursing, Karaikal, Puducherry (U.T),Vinayaka Mission's Research Foundation (DU) - Salem, Tamil Nadu, India.

Received: 01 Nov 2021

Revised: 16 Dec 2021

Accepted: 06 Jan 2022

### \*Address for Correspondence

**Venkatesan M P**

Ph.D Scholar,

Vinayaka Mission's College of Nursing,

Karaikal, Puducherry (U.T),

Vinayaka Mission's Research Foundation(DU),

Salem,Tamil Nadu, India.



This is an Open Access Journal / article distributed under the terms of the **Creative Commons Attribution License** (CC BY-NC-ND 3.0) which permits unrestricted use, distribution, and reproduction in any medium, provided the original work is properly cited. All rights reserved.

### ABSTRACT

Smartphone usage among school children becomes very common now a day. Internet has the power to connect the people around the world and current scenario the availability of the data is becoming very cheaper makes everyone connected throughout the day. School students are not aware how effectively use the internet and easily becomes the victim of excessive smartphone. This study mainly focused on internet addiction among 250 school students identified 105 (42%) of them having mild internet addiction, 45 (18%) of them having moderate internet addiction, 25(10%) of them having severe internet addiction and 75 (30%) are not having internet addiction. Regarding knowledge on internet addiction among school students 180 (72%) having inadequate knowledge, 45(18%) of them having moderately adequate knowledge and 25(10%)of them having adequate knowledge significant association found between demographic variables with knowledge on internet addiction among school students.

**Keywords:** Internet, Smartphone ,addiction. knowledge, school students

### INTRODUCTION

Internet and smartphone are the two major technologies have changed the lifestyle of the people in dramatically different. Smartphone becomes the best companion of everyone in the technological society. The daily connected time in internet has been increased drastically long time since the availability of the data becomes easy and easy



**Venkatesan and Kamala**

availability of the gadgets such as smartphones. [1] According to Joseph Johnson worldwide 4.66 Billion users are found which 59.5% of the global population. Among this 4.32 billion (92.6%) users were accessing internet via smartphone devices. China is the first country with active 854 million internet users before India which has 560 million internet users [2] Internet addiction is a global problem among people whose daily life is affected with excessive smartphone usage/ problematic internet usage, they becomes the victim of smartphone addiction specifically internet addiction disorder (IAD). The most common part of internet addiction can be in the form of internet compulsion, gaming addiction, social networking, cyber relationship compulsion, information seeking, online shopping, pathological social media use and internet pornography.[3][4] According to Gedam et al., a cross sectional study conducted to the 846 university students in India; identified the overall prevalence rate of internet addiction was 19.85% which is found to be moderate and severe type of internet addiction .Male students found to be affected more than female students. Significant association found between the demographic variables of gender, computer ownership, preferred time, login status and mode of internet access. Emotional ties and psychological distress was important predictor of internet addiction. [5]The sign and symptoms of internet addiction would be physical problem and emotional or psychological problems. Anxiety, depression, feeling guilty, isolation, mood swings, anger, loneliness etc are found to be more significant emotional factors whereas the physical factors are headache, back pain, sleeplessness, stiff neck, eye strain, lack of personal hygiene, poor nutrition, weigh gain/ loss. People suffering from the problem prone to develop coupled physical and emotional problem of above mentioned based on the severity of the internet addiction. [6]Dong H et al in their study on internet addiction and related psychological factors among children and adolescent in china during Covid-19 pandemic among 2015 students of 6-18 years old. Study identified 684(33.37%) of the students found to have problematic inter usage and 55(2.68%) found to have addictive internet use. Covid 19 lockdown has increased the frequency and intensity of the internet usage and significant association found between gender, age, depression and stress [7].

Statement of the problem:

An explorative study to evaluate internet addiction among school students (10-15 yrs.) in Karaikal.

**Objective**

To determine the level of internet addiction among school students.

To assess the level of knowledge on internet addiction among school students

To associate the selected demographic variables with knowledge on internet addiction

**MATERIAL AND METHODS**

Descriptive design was incorporated in this study to evaluate internet addiction among school students (10-14 yrs.) in Karaikal. 250 students from the class of 6<sup>th</sup> standard to 10<sup>th</sup> standard each class 50 students were selected in this study. All the procedures were informed to the students and got the informed consent who has accepted to participate in the study. Modified internet addiction scale was used to assess the level of addiction among school students. Semi structured questionnaire on knowledge about smart phone addiction along with demographic profiles were used to assess the level of knowledge and base line data among school students.

**RESULTS**

Table 1 represents frequency and percentage distribution of demographic variable of the school students. According to the age 91(36.4%) are 14-15 years, 81(32.4%) are 12-13 years and 78(31.2%) are 10-11 years. Regarding gender of the students 138(55.2%) of them belongs to male and 112(54.8%) belongs to female children. Based on the religion 165(66%) were Hindu, 50(20%) were Muslim and remaining 35(14%) were Christian students. According to the standard studying each 50(20%) of them belongs to 6<sup>th</sup> to 10<sup>th</sup>standard Based on family income 100(40%) of them belongs to the category of 10,001-20,000, 62(24.8%) are belongs to the category of 5001-10000; 50(20%) of them



**Venkatesan and Kamala**

belongs to > 20,000/- and 38(15.2%) of them belong to <5000/- category. Based on the last examination academic performance 90(36%) of them secured 35-49% of marks,81(32.4%) of them secured 0-34% of marks, 51(20.4%) of them secured 50-59% of marks and 28(11.2%) of them secured 60-100 % of mark. According to daily usage time of internet 175(70%) of them using > 4 hrs. per day, 58(23.2%) of them using 2-4 hrs. per day and 18(7.2%) of them using <1 hr. per day. Based on the type of internet used 182(72.8%) of them using 4G data,48(19.2%) of them using broad band connection and 20(8%) of the using 3G network for internet access. Based on the sleep duration of the students 150(60%) of them sleeping 4-6 hrs, 63(25.2%) sleeping 6-8hrs and 37(14.8%) of them sleeping < 4 hours per day.

Table 2 and figure 1 illustrates the level of internet addiction among school children found 105(42%) of them having mild internet addiction, 45(18%) of them having moderate internet addiction, 25(10%) of them having severe internet addiction and 75(30%) are not having internet addiction. Table 3 and figure 2 shows the level of knowledge on internet addiction among school children shows 180(72%) of the students having inadequate knowledge, 45(18%) of them having moderately adequate knowledge and 25(10%) of them only having adequate knowledge on internet addiction. table 4 shows there was no significant association found between the knowledge on internet addiction and selected demographic variables.

**DISCUSSION**

The present study result shows that 105(42%) of them having mild internet addiction, 45(18%) of them having moderate internet addiction, 25(10%) of them having severe internet addiction and 75(30%) are not having internet addiction. Similar study was conducted by 58% of the students having internet addiction whereas 42% of them not having the addiction. A cross sectional study conducted by Daya A, P., & G, K. (2018) on prevalence of addictive internet use among urban school children in Tamilnadu, identified 53(35.4%) of the children having no addiction, 63(42%) of them having mild addiction, 29(19.3%) having moderate addiction and 5(3.3%) of the having severe level of internet addiction.[8] Kiran H Mali et al., conducted study on the prevalence of internet addiction in adolescent junior college students in Navi Mumbai identified the result of 58(38.67%) of normal internet users, 62(41.33%) of mild form of addiction, 27(18%) of moderate form of addiction and 3 (2%) of severe form of internet addiction.[9] Regarding the knowledge on internet addiction among school children identified 180(72%) of the students having inadequate knowledge, 45(18%) of them having moderately adequate knowledge and 25(10%) of them only having adequate knowledge on internet addiction. Association of demographic profiles with knowledge on internet addiction found there was no association found by age, gender, religion, standard studying, academic performance, daily using time, type of internet connection used and sleep duration. similar study conducted by Anjumohan et al., conducted study on Knowledge on Factors Influencing Internet Addiction among Adolescents among 100 students in Govt. Higher Secondary School, Kollam found there was only significant association between knowledge level and income and no any other association was found between any of the factors of the demographic variables [10].

**CONCLUSION**

In the present study, internet addiction among school students found 42% of mild, 18% moderate and 10% of severe form. Regarding knowledge on internet addiction found 72% of inadequate, 18% of moderately adequate and 10% of adequate level. The prevalence of internet addiction and inadequate knowledge significant showing high among school students hence it is recommended to conduct more number of research studies in the thrust area to improve the knowledge and decrease the prevalence of internet addiction.

**ACKNOWLEDGMENT**

Researcher has grateful to the study participants for their cooperation and participation through the study period.





### Venkatesan and Kamala

**Financial support and sponsorship**

NIL

**Conflicts of interest**

NIL

**Ethical clearance**

Obtained from institutional research committee

**REFERENCES**

1. Natalie Hoge. Internet addiction. Addiction center.retrieved from <https://www.addictioncenter.com/drugs/internet-addiction/>
2. Joseph Johnson. worldwide digital population as of Jan 21.reterived from <https://www.statista.com/statistics/617136/digital-population-worldwide/>
3. Christina Gregory. Internet addiction disorder.retrieved from <https://www.psychom.net/iadcriteria.html>
4. Shaw, M., & Black, D. W. Internet addiction: definition, assessment, epidemiology and clinical management. *CNS drugs*, 2008, 22(5), 353–365. <https://doi.org/10.2165/00023210-200822050-00001>
5. Gedam SR, Ghosh S, Modi L, Goyal A, Mansharamani H. Study of internet addiction: Prevalence, pattern, and psychopathology among health professional undergraduates. *Indian J Soc Psychiatry* 2017;33:305-11
6. Camille renzoni.Internet addiction.the recovery village.retrieved from <https://www.therecoveryvillage.com/process-addiction/internet-addiction/>
7. Dong H, Yang F, Lu X and HaoW.Internet Addiction and Related Psychological Factors Among Children and Adolescents in China During the Coronavirus Disease 2019 (COVID-19) Epidemic. *Front. Psychiatry* 2020 11:00751. doi: 10.3389/fpsyt.2020.00751
8. Daya A, P., & G, K. (2018). Prevalence of addictive internet use and its correlates among urban school students in Tamilnadu, South India – a cross-sectional study. *Public Health Review: International Journal of Public Health Research*, 5(2), 60- 64. <https://doi.org/10.17511/ijphr.2018.i2.02>
9. Kiran H Mali, PradeepSawardekar, SeemaAnjenaya, V J Mahadik. A study to assess internet addiction among adolescent junior college students of Navi Mumbai, India *MedPulse– International Medical Journal* 2015; 2(12):894-896
10. Anjumohan et al..Knowledge on Factors Influencing Internet Addiction among Adolescents in Selected Higher Secondary School, Kollam. *International Journal of Nursing Education and Research*,2018;6(1),41-43.

**Table 1: Frequency and percentage distribution of demographic variables n=250**

S.no	Demographic variables	Frequency	Percentage
1.	<b>Age</b>		
	10-11	78	31.2%
	12-13	81	32.4%
	14-15	91	36.4%
2.	<b>Sex</b>		
	Male	138	55.2%
	Female	112	54.8%
3.	<b>Religion</b>		
	Hindu	165	66%
	Muslim	50	20%
	Christian	35	14%
4.	<b>Standard studying</b>		
	6 <sup>th</sup> standard	50	20%
	7 <sup>th</sup> standard	50	20%





### Venkatesan and Kamala

	8 <sup>th</sup> standard	50	20%
	9 <sup>th</sup> standard	50	20%
	10 <sup>th</sup> standard	50	20%
5.	<b>Family monthly income</b>		
	Less than Rs. 5,000	38	15.2%
	Rs. 5,001 – 10,000	62	24.8%
	Rs. 10,001- 20,000	100	40%
	Above Rs. 20,001	50	20%
6.	<b>Academic performance</b>		
	60-100 %	28	11.2%
	50-59 %	51	20.4%
	35-49 %	90	36%
	0-34 %	81	32.4%
7.	<b>Daily using time</b>		
	Less the 1 hour	18	7.2%
	2- 4 hours	58	23.2%
	More than 4 hours	175	70%
8.	<b>Type of internet access used</b>		
	Broadband	48	19.2%
	3G network	20	8%
	4G network	182	72.8%
9.	<b>Sleep duration</b>		
	6-8 hours	63	25.2%
	4-6 hours	150	60%
	Less than 4 hours	37	14.8%

**Table 2: Level of internet addiction among school students**

S.no	Level of internet addiction	Frequency	Percentage
1.	Not addicted	75	30%
2.	Mild addiction	105	42%
3.	Moderate addiction	45	18%
4.	Severe addiction	25	10%

**Table 3: Level of knowledge on internet addiction among school students**

S.no	Knowledge on internet addiction	Frequency	Percentage
1.	Adequate	25	10%
2.	Moderately adequate	45	18%
3.	Inadequate	180	72%





**Venkatesan and Kamala**

**Table 4: Association between knowledge on internet addiction with selected demographic variables=250**

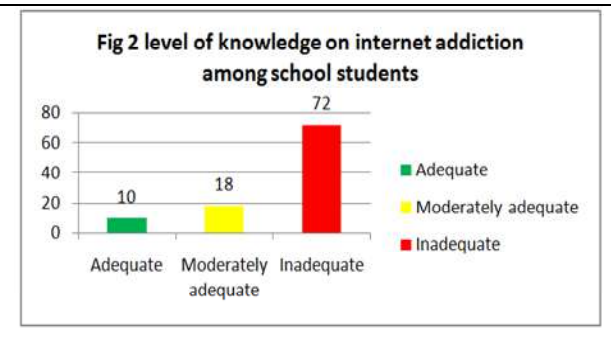
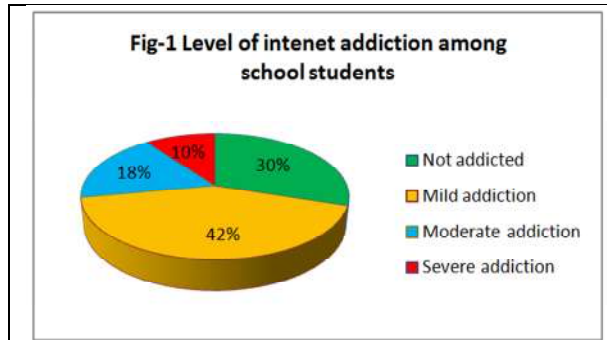
S.no	Demographic variables	F	Knowledge on internet addiction			$\chi^2$ Value	P value
			A	MA	IA		
1.	<b>Age</b>					0.1132	0.9984 (NS)
	10-11	78	8	14	56		
	12-13	81	9	15	57		
	14-15	91	9	16	66		
2.	<b>Sex</b>					0.0117	0.9941 (NS)
	Male	138	14	25	99		
	Female	112	11	20	81		
3.	<b>Religion</b>					0.0635	0.9995 (NS)
	Hindu	165	17	30	118		
	Muslim	50	5	9	36		
	Christian	35	4	6	25		
4.	<b>Standard studying</b>					0.6165	0.9997 (NS)
	6 <sup>th</sup> standard	50	5	9	36		
	7 <sup>th</sup> standard	50	4	10	36		
	8 <sup>th</sup> standard	50	4	11	35		
	9 <sup>th</sup> standard	50	5	9	36		
	10 <sup>th</sup> standard	50	5	9	36		
5.	<b>Family monthly income</b>					0.0307	0.9999 (NS)
	Less than Rs. 5,000	38	4	7	27		
	Rs. 5,001 – 10,000	62	6	11	45		
	Rs. 10,001- 20,000	100	10	18	72		
	Above Rs. 20,001	50	5	9	36		
6.	<b>Academic performance</b>					0.0417	0.9999 (NS)
	60-100 %	28	3	5	20		
	50-59 %	51	5	9	37		
	35-49 %	90	9	16	65		
	0-34 %	81	8	15	58		
7.	<b>Daily using time</b>					0.0562	0.9996 (NS)
	Less the 1 hour	18	2	3	13		
	2- 4 hours	58	6	10	42		
	More than 4 hours	174	17	31	126		
8.	<b>Type of internet access used</b>					0.0336	0.9998 (NS)
	Broadband	48	5	9	34		
	3G network	20	2	4	14		
	4G network	182	18	34	130		
9.	<b>Sleep duration</b>						





**Venkatesan and Kamala**

6-8 hours	63	6	12	45	0.0842	0.9991 (NS)
4-6 hours	150	15	27	108		
Less than 4 hours	37	4	7	26		



**Fig-1 Level of internet addiction among school students**

**Fig 2 level of knowledge on internet addiction among school students**







## Preliminary Phytochemical Screening and GCMS Analysis of *Limnobium laevigatum* Hump and Bonpl: South American Sponge Plant

Keserla Bhavani<sup>1\*</sup>, G. Alagu Manivasagam<sup>2</sup> and Amit Kumar Das<sup>3</sup>

<sup>1</sup>Assistant Professor, Department of Pharmacology, Krupanidhi College of Pharmacy, Bangalore, Karnataka, India.

<sup>2</sup>Professor, Department of Pharmacy, Annamalai University, Chidambaram, Tamil Nadu, India.

<sup>3</sup>Professor, Acharya B.M. Reddy College of Pharmacy, Bangalore, Karnataka, India.

Received: 14 Nov 2021

Revised: 23 Dec 2021

Accepted: 12 Jan 2022

### \*Address for Correspondence

#### Keserla Bhavani

Assistant Professor,  
Department of Pharmacology,  
Krupanidhi College of Pharmacy,  
Bangalore, Karnataka, India.  
E.Mail: bhavanik76@gmail.com



This is an Open Access Journal / article distributed under the terms of the **Creative Commons Attribution License** (CC BY-NC-ND 3.0) which permits unrestricted use, distribution, and reproduction in any medium, provided the original work is properly cited. All rights reserved.

### ABSTRACT

The present study is to evaluate the phytochemical constituents from the methanolic extract of *Limnobium laevigatum* Hump and Bonpl. Seaweeds are excellent sources of biologically active ingredients. Several Asian countries have a strong tradition of various seaweeds in herbal medicine preparations. These plants contain various phytochemical constituents. They are potentially prolific sources of highly bioactive secondary metabolites, which manifest various therapeutic effects like anticancer, anti-inflammatory, antioxidant, antidiabetic properties. In the present study phytochemical investigation of the seaweed *Limnobium laevigatum* Hump and Bonpl was studied. The constituents that are identified are alkaloids, tannins, phenols, proteins and amino acids, steroids, terpenoids, glycosides, quinines, fixed oils and resins. GC-MS analysis was done on prepared methanolic extract of *Limnobium laevigatum* Hump and Bonpl for identifying the bioactive compounds. By GC-MS analysis 9 varieties of compounds are identified. Among which hexadecenoic acid, pentadecanoic acid, dodecanal, sigma steroyl tosylate are the major compounds. Many of them have antioxidant, anticancer, antidiabetic, anti-inflammatory and anti-hyperlipidaemic and antiangiogenic properties.

**Keywords:** Traditional uses, Phytochemical screening, GCMS analysis, *Limnobium laevigatum*, Methanolic extract



**Keserla Bhavani et al.,**

## INTRODUCTION

Plant derived compounds are fascinating the world due to their multifaceted therapeutic uses in modern medicine. Medicinal plants are abundant in bio-sources of drugs used in traditional medicine, nutraceuticals, food supplements, folk medicines, pharmaceutical intermediates and chemical entities for developing synthetic drugs [1]. Plants have been used as traditional medicine for several thousand years. It is used in herbal drugs in the treatment of diseases found among all sections of people in India. The world market for herbal medicine including herbal products and raw materials has been estimated to have an annual growth rate between 5 and 20% [2]. Plants are the storehouses and sources of safer and cheaper chemicals. Herbal preparations have an important role in disease control due to their antioxidant properties. The hormones, antibiotics, vitamins and several other chemicals have been tested as growth promoters and antibacterial agents and for other purposes in mariculture [3]. Green leaves form a rich source of dietary fibres, nutraceuticals, vitamins and minerals which promotes various activities like growth promotion, appetite stimulation, antistress activity, tonic and immune stimulation Therefore, this work is to evaluate the phytochemical constituents of aquatic weed *Limnobium laevigaetum* Hump and Bonpl which is commonly called as South American sponge plant and their biological activities. *Limnobium laevigaetum* Hump and Bonpl. is similar to the species *Eichhorniacrassipes* and *Hydrilla verticella* which has the properties of antioxidant, anti-microbial, anti-diabetic and anti-cancer [5].

## MATERIALS AND METHODS

### Collection and Authentication of plant Material

The aquatic weed *Limnobium laevigaetum* Hump and Bonpl. was collected from nurseries of Sree Padma Aqua flora, Aluva, Kerala, India. This plant was identified and authenticated in Department of Botany, Sri Venkateswara University at Tirupathi, Andhra Pradesh, India by the botanist K. Madhav Shetty. The herbarium was prepared and stored with specimen number 1047.

### Preparation of plant extract

The whole plant of *Limnobium laevigaetum* was washed with fresh water to remove the debris, epiphytes and adhered materials. Crude extract was obtained after maceration with 95% methanol and repeated till exhaustion of the material at room temperature. Thereafter, the methanolic extract was distilled, evaporated and dried under pressure to yield methanolic extract [6].

### Phytochemical screening of plant extract

Methanolic extract of *Limnobium laevigaetum* Hump and Bonpl. was subjected to different qualitative chemical tests for chemical composition [7]. Qualitative phytochemical analysis was performed based on the method of Sofawara, Trease and Evans and Harborne [8].

### Detection of alkaloids

Methanolic extract of *Limnobium laevigaetum* was dissolved in dilute hydrochloric acid and filtered

- Mayer's test includes methanolic extract treated with potassium mercuric iodide (Mayer's reagent). Formation of yellow coloured precipitate indicates the presence of alkaloids.
- Wager's test includes methanolic extract was treated with iodine in potassium iodide (Wagner's reagent). Formation of brown/reddish precipitate indicates the presence of alkaloids.
- Dragondroff's test includes methanolic extract was treated with solution of potassium bismuth iodide (Dragondroff's reagent). Formation of red coloured precipitate indicates the presence of alkaloids.
- Hager's test includes methanolic extract treated with Hager's reagent (Saturated Picric acid solution). Formation of yellow coloured precipitate indicates the presence of alkaloids [9].





**Keserla Bhavani et al.,**

#### **Detection of Carbohydrates**

Methanolic extract was dissolved in 5ml of distilled water and filtered. The filtrate was used to test for the presence of carbohydrates.

- Molisch's test includes methanolic extract treated with 2 drops of alcoholic  $\alpha$ - naphthol solution in a test tube. Formation of violet ring at the junction indicates the presence of carbohydrates.
- Benedict's test includes methanolic extract treated with Benedict's reagent and heated gently. Orange red precipitate indicates the presence of reducing sugars.
- Fehling's test includes methanolic extract was hydrolysed with dil. HCl, neutralised with alkali and heated with Fehling's A and B solutions. Formation of red precipitate indicates the presence of reducing sugars

#### **Detection of Glycosides**

Methanolic extract was hydrolysed with Dil. HCl and then subjected for glycosides test.

- Modified Borntrager's test includes methanolic extract treated with ferric chloride solution and immersed in boiling water for about 5 minutes. The mixture was cooled and extracted with equal volumes of benzene. The benzene layer was separated and treated with ammonia solution. Formation of pink colour indicates the presence of anthraquinone glycosides.
- Legal's test includes methanolic extract treated with sodium nitroprusside in pyridine and sodium hydroxide. Formation of pink colour to blood red colour indicates the presence of cardiac glycosides [10].

#### **Detection of Saponins**

- Froth test includes methanolic extract diluted with distilled water to 20ml and this was shaken for 15min. Formation of layer of froth indicates the presence of saponins.
- Foam test includes 0.5mg of methanolic extract shaken with 2ml of water. If foam produced persists for ten min it indicates the presence of saponins.

#### **Detection of Phytosterols**

- Salkowski's test includes methanolic extract treated with few drops of concentrated sulphuric acid shaken and allowed to stand. Appearance of golden yellow colour indicates the presence of phytosterols.
- Libermann Buchard's test include methanolic extract treated with chloroform and filtered. The filtrate was treated with few drops of acetic anhydride boiled and cooled. Concentrated sulphuric acid was added. Formation of brown ring at the junction indicates the presence of phytosterols [11].

#### **Detection of phenols**

Ferric chloride test includes methanolic extract treated with 3-4drops of ferric chloride solution. Formation of bluish black colour indicates the presence of Phenols.

#### **Detection of tannins**

Gelatin test includes the methanolic extract, 1% gelatin solution containing sodium chloride was added. Formation of white precipitate indicates the presence of tannins.

#### **Detection of flavonoids**

- Alkaline reagent test includes methanolic extract treated with few drops of sodium hydroxide solution. Formation of intense yellow colour which becomes colourless on addition of dilute acid indicates the presence of flavonoids.
- Lead acetate test includes methanolic extract treated with few drops of lead acetate solution. Formation of yellow coloured precipitate indicates the presence of flavonoids [12]

#### **Detection of proteins and amino acids**

- Xanthoproteic test includes ethanolic extract treated with few drops of concentrated nitric acid. Formation of yellow colour indicates the presence of proteins.



**Keserla Bhavani et al.,**

- Ninhydrin test includes the extract 0.25% w/v ninhydrin reagent was added and boiled for few minutes. Formation of blue colour indicates the presence of amino acid.

**Detection of diterpenes**

Copper test includes extract dissolved in water and treated with 3-4 drops of copper acetate solution. Formation of emerald green colour indicates the presence of diterpenes<sup>13</sup>

**GCMS Analysis of the plant extract**

GCMS analysis of active fractions of *Limnobia laevigatum*, sea weed was performed using GC Perkin Elmer Clarus 680 system and gas chromatograph interfaced to a mass spectrometer. *Limnobia laevigatum* was extracted with packed Elite-5MS (5% biphenyl, 95% dimethyl polysiloxane) and compounds was separated using Helium as carrier gas at a constant flow of 1ml/min. The injector temperature was set at 260°C during chromatograph run [14]. One µl of the extract was injected into the instrument over the temperature 60°C followed by 300°C at a rate of 10°C±1. The run time was 6min to 30 min. The compounds are identified with the help of NIST libraries base on their molecular mass.

**RESULTS**

Phytochemical analysis of sample results displayed that the extract of *Limnobia laevigatum* contains proteins, amino acids, alkaloids, tannins, steroids, terpenoids, quinones, glycosides, fixed oils, resins [15]. GCMS is one of the best methods to identify the active plant extract. GCMS of methanolic extract of *Limnobia laevigatum* showed peaks indicate the presence of various phytochemical constituents. In the present study the phytochemical constituents were successfully extracted using methanolic extracts ranging the polarity [16]. The various phytochemical properties which contribute the medicinal activity of the plant are anticancer, anti-hyperlipidaemic, antidiabetic, antiarrhythmic, antiandrogenic, antimicrobial, analgesic, anti-inflammatory, anti-angiogenic properties. The phytochemicals include fatty acids, cholesterol, steroid hormones [17]. Active principles of the methanolic extract of *Limnobia laevigatum* are detected with their retention time, molecular formula, molecular weight and peak area % respectively. They were identified as n- hexadecenoic acid, 9- octa decenal, penta decanoic acid, erucic acid, 8- Hepta decene 1- chloro, Pentadecenal, Hexadecenal, Cholesta-8-24-dien-3-ol, Pentanoic acid respectively and their retention time 19.56, 19.7, 21.03, 22.70, 22.84, 22.94, 23.09, 27.7, 28.3 and Molecular weight concentration were 256, 266, 242, 338, 272, 226, 240, 398, 133 respectively.

**DISCUSSION**

Phytochemical analysis refers to extraction, screening and identification of the medicinally active components found in the plant. The bioactive components derived from the plants are glycosides, alkaloids, steroids, tannins, phenols and antioxidants. These bioactive compounds have medicinal values. Seaweeds contain many bioactive compounds of medicinal value with potential pharmaceutical application. The qualitative phytochemical analysis was carried out in the methanolic extract of *Limnobia laevigatum* for different chemical constituents [18]. It was observed that the extract contains alkaloids, tannins, saponins, glycosides, steroids, resins, quinones and fixed oils. This study demonstrates that the presence of alkaloids suggest that it can be used as a medicinal drug [19]. Tannins may bind to proline rich protein and interfere with protein synthesis. Saponins have a property of precipitating and coagulating RBC, Cholesterol binding properties, bitterness and haemolytic activity. Glycosides have a property of antidiabetic, Due to the presence of phytosterols it is used as antimicrobial and antiarrheal agent [20]. The phytoconstituents of the plant extract may possess antibacterial, antioxidant, anticancer, antidiabetic and anti-inflammatory properties. The present study demonstrates that the GCMS analysis of methanolic extract of *L. laevigatum* reveals the presence of fatty acids and antioxidant properties. The active principles with their retention time, molecular formula and molecular weight are presented in Table: 2 [21].





Keserla Bhavani et al.,

Hexadecanoic acid and pentadecanoic acid is known to have anticancer, antiarrhythmic, antidiabetic, antimicrobial, antifungal properties. Erucic known to have anti- inflammatory, antidiabetic and hypocholesteraemia properties. Pentanoic acid and heptadecane present in the extract known to have anti -tumour, antimicrobial and antifungal properties [22].

## CONCLUSION

In the present study, methanolic extract of the *Limnobiium laevigaetum* Hump and Bonpl. contains active compounds such as alkaloids, terpenoids, saponins, resins, quinones, phenols, fixed oils and glycosides. GCMS analysis shows the 9 compounds which are biologically active. Furthermore, studies were carried out to perform the isolation and characterisation of bioactive compounds by FTIR and NMR. Invitro and in vivo animal studies were further investigated for potential medicinal properties of *Limnobiium laevigaetum* Hump and Bonpl.

## ACKNOWLEDGEMENTS

Authors would like to thank the Sree Padma Aqua flora, Aluva, Kerala and Refysyn Biosciences, Pondicherry for supporting during the study.

## REFERENCES

1. Revathi P, Jeyaseelansethinath T, Thirumalaikolundhusubramanian P, Phytochemical screening and GCMS analysis of ethanolic extract of Mangrove plant – *Bruguiera cylindrica* (Rhizo) L.: International Journal of Pharmacognosy and phytochemical research: 2014-15:6(4): 729-740.
2. Nazerath Nisha, Anbu Jothi B, B Geetha, S Hanira, Phytochemical analysis of *PistiaStratiotes* by GC-MS analysis – National Journal of Multidisciplinary Research and Development: Volume 3: Issue 1: January 2018: Pg. no. 4-6.
3. Prabhu V V, Guruvayoorappan C, Phytochemical screening of methanolic extract of mangrove *Avicennia marina* Vierh Pharm sin 2012: 2:307-10.
4. Usha N S, Sabari Anand J.V. Mangaiyarkrasi- Preliminary phytochemical screening and GCMS analysis of *Cladophora glomerata*: green marine algae- International Journal of Basic & Clinical Pharmacology; Volume 8; Issue 4; Pg. no 732-736.
5. Thamarai Selvi, Lalitha P, Jayanthi P – Preliminary studies on phytochemicals and antimicrobial activity of solvent extracts of *Eichhornia crassipes*: Asian Journal of plant Science and research; 2012; volume 2; Issue 2; Pg. no. 115- 122.
6. Neivys Garcia Delgado, Ana iris Frias Vazquez, Hiran Cabrera Sanchez, Roberto Menendez, Soto del Valle, Yusvel Sierra Gomez – Anti- inflammatory and anti-nociceptive activity of methanolic extract of red seaweed *Dichotomaria obtusata*- Brazilian Journal of Pharmaceutical Sciences; 2013; Volume 49: Pg. no 65-71.
7. Tiwari P, Kumar B, Kaur G, Kaur H- Phytochemical screening and extraction: a Review; Inter pharmaceutical Sciences; 2011;1(1):98-106.
8. Mythili T, Ravindran R- Phytochemical Screening and antimicrobial activity of *Sebania sesban* (L.)- Asian Journal of Pharm Clinical Research :2012; 5(4); 179-182.
9. Whankatte VR, Ambhore JS- Study of phytochemical screening and antioxidant activities of *Cladophora glomerata* Linn. Collected from Raigad coast of Kongan District, India, J Sci Nat. 2016:7:659-663.
10. Sofowora EA, Medicinal Plant and traditional medicine in Africa, University of Ife Press, Nigeria, 1994;1:1-23.
11. Trease GE, Evans WC, Phytochemical Screening in Textbook of Pharmacognosy: 1989: 10<sup>th</sup> Edition, bailliere Tindal Limited, London, pp-541.
12. Firdous S, Alam P, Phytochemical investigation of extract of *Amorphophallus campanulatus* tubers. International Journal of Phytomedicine, 2011:3:32-35.
13. Khandelwal KR, Practical Pharmacognosy, Nirali Prakashan, 1995: pp149-155.





## Keserla Bhavani et al.,

14. Kumar A, Paul S, Pingalkumari, S. Somasundaram T, Kathiseran K, Antibacterial and Phytochemical assessment on various extracts of *Ipomea pes -carpe*, GCMS analysis- Asian Journal Pharm Clin Res 2014;7(3):134-138.
15. Kakarla L, Comparative Biochemical studies on Indian sedges *Cyperus scariosus* and *Cyperus rotundas*L.; Pharmacognosy Journal 2016:598-609.
16. Hema R, GCMS analysis on the potentials of *Syzygium aromaticum*: Researcher2.12:2010:1-4.
17. Manorenjitha MS, Norita AK, Norisham S, Asmawi MZ, GCMS analysis of bioactive components of *Ficus religiosa* -Indian Journal of Phar Bio Sci 2013; 4(2):99-103.
18. Lima AL, Parial R, Das M, Das AK- Phytochemical and pharmacological studies of ethanolic extract of leaves of Mangroove plant *Phoenix paludosa*- Malaysian Journal of Pharmaceutical Sciences;2010;8(2):59-69.
19. Babu PV, Liu D, Gilbert ER-Recent advances in understanding the antidiabetic activity of dietary flavonoids- J Nutr Biochem 2013;24(11):177-189.
20. Edeoga HO, Okwu DE, Mbaebie BO -Phytochemical constituents of some Nigerian medicinal plants. African Journal Biotechnology 2005;4(7): 685-688.
21. Soonthornchareonnon N, Wiwat C, Chuakul W, Biological Activities of medicinal plants from Mangroove forests: Journal of Pharmaceutical Science: 2012: 3(9):9-18.
22. Rajeswari G, Murugan M, Mohan VR, GCMS analysis of bioactive components of *Hugoniamystax* bark. J Pharm Biomed Sci 2013: 29(29): 818-824.

**Table: 1 Qualitative phytochemical analysis of methanolic extract of *Limnobiium laevigaetum***

SI. no.	Phytochemical test	Name of the test	Methanolic extract of <i>Limnobiium laevigaetum</i>
1	Carbohydrate	Benedict's test	Absent
2	Proteins and amino acids	Millon's test	Present
3	Alkaloids	Dragondroff's test	Present
4	Tannins and Phenols	Ferric chloride test	Present
5	Flavonoids	Zn-Hcl test	Absent
6	Steroids/Terpenoids	Salkowski test	Present
7	Saponins	Froth test	Absent
8	Glycosides	Killer Kiliani test	Present
9	Quinones	NaOH test	Present
10	Fixed oil	Paper/ spot test	Present
11	Resins	Acetone test	Present
12	Coumarins	Fluorescence test	Absent

**Table : 2 Compounds identified in the crude extract of *Limnobiium laevigaetum* Hump & Bonpl. by GCMS analysis**

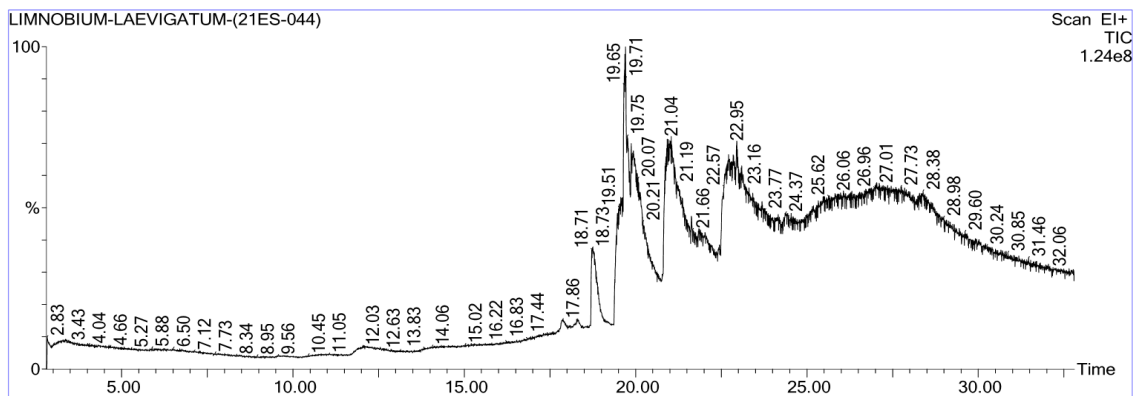
SI No.	RT	Compound	Molecular Formula	Molecular Weight	% Area	Pharmacological Activity
1.	19.56	Hexadecanoic acid	C <sub>16</sub> H <sub>32</sub> O <sub>2</sub>	256	7.47	Anticancer, Antiarrhythmic, Antiandrogenic, Hypercholesteraemic, Antidiabetic.
2	19.7	9-Octadecenal	C <sub>18</sub> H <sub>34</sub> O	266	14.83	Antimicrobial, Antioxidant, Antifungal
3	21.036	Pentadecanoic acid	C <sub>15</sub> H <sub>30</sub> O <sub>2</sub>	242	18.29	Antioxidant, Anticancer, Lubricant, Hyperchloreemic, Nematicide





**Keserla Bhavani et al.,**

4	22.706	Erucic acid	C <sub>22</sub> H <sub>42</sub> O <sub>2</sub>	338	8.71	Anti- inflammatory, Antidiabetic, Hypocholesteraemic
5	22.84	8-hepatdecene,1-Chloro	C <sub>17</sub> H <sub>33</sub> Cl	272	2.81	Antibacterial, Anti-inflammatory, Anticholinergic
6	22.94	Pentadecenal	C <sub>15</sub> H <sub>30</sub> O	226	3.22	Antibacterial, Antifungal, Antioxidant, Hypolipidemic
7	23.09	Hexadecenal	C <sub>16</sub> H <sub>32</sub> O	240	4.22	Antioxidant, Antiproliferative
8	27.7	Cholesta-8-24dien-3-ol	C <sub>28</sub> H <sub>46</sub> O	398	3.87	Antineoplastic, Antioxidant, Free Radical damage to DNA, Antiandrogenic.
9	28.3	Pentadecanoic acid	C <sub>5</sub> H <sub>11</sub> O <sub>3</sub>	133	4.25	Antitumour, Antimicrobial, Antifungal



**Fig:1 Chromatogram analysis of *Limnobium laevigatum***





## Germination Studies on Combined Mutagenic Treatment Employing Gamma Rays and EMS in African Marigold (*Tagetes erecta* L.)

Aravind S<sup>1\*</sup> and Dhanavel D<sup>2</sup>

<sup>1</sup>Research Scholar, Division of Cytogenetics and Mutation Breeding, Department of Botany, Annamalai University, Tamil Nadu, India.

<sup>2</sup>Professor, Division of Cytogenetics and Mutation Breeding, Department of Botany, Annamalai University, Tamil Nadu, India.

Received: 21 Nov 2021

Revised: 26 Dec 2021

Accepted: 12 Jan 2022

### \*Address for Correspondence

#### Aravind S

Research Scholar,  
Division of Cytogenetics and Mutation Breeding,  
Department of Botany, Annamalai University,  
Tamil Nadu, India.  
Email: arvinofpb97@gmail.com



This is an Open Access Journal / article distributed under the terms of the **Creative Commons Attribution License** (CC BY-NC-ND 3.0) which permits unrestricted use, distribution, and reproduction in any medium, provided the original work is properly cited. All rights reserved.

### ABSTRACT

The essence of natural variation was embraced through mutation breeding, which enhanced natural selection at its apex without negatively impacting the environment. This study utilized a combination of subsequent doses/conc. of gamma ray and EMS ranging from [0 (Control), 10 KR + 10 mM, 20 KR + 20 mM, 30 KR + 30 mM, 40 KR + 40 mM and 50 KR + 50 mM] to induce mutagenesis in *Tagetes erecta*. The purpose of this study is to determine the lethality of combined treatment in African Marigold. In contrary to the control, this study revealed that the germination percentage, germination speed index, seed vigour, and seedling survival of other combined mutagenic treatments were significantly lowered. Overall, this work is one of the pioneering approaches in *T. erecta*. using combined mutagenesis and provide a combined mutagenesis-based plant breeding programme in *T. erecta*.

**Keywords:** African Marigold, Combined Mutagenesis, EMS, Gamma Rays, Germination percentage, LD<sub>50</sub> value, Plant breeding, Ornamental crop.

### INTRODUCTION

The adequate theory of heredity that accounts for the provenance of variations in the generation alleged by natural selection brings forth speculation in evolutionary ideas which determined the emergence of mutation theory. In recent years, the traditional approach of generating mutation in plant breeding has gained a lot of traction and it now





**Aravind S and Dhanavel D**

plays a significant role in crop development[1]. Due to its effectiveness in creating novel kinds in a short period, the field of mutation breeding is gaining popularity[2]. Previously, the application of mutagenesis in breeding entailed the advancement of genetic screening, selecting individual mutants with improved characteristics, and integrating them into breeding strategies. The reverse genetic techniques are predicated on the generation of mutagenized populations. However, the collections of procurements with spontaneous polymorphisms can also be utilized. To determine that every target gene contains sufficient substantial mutations, the induced mutant's population might have to be exceedingly enormous, and depend on the dose of mutagen. The frequency of gene duplication established by recent or prehistoric polyploidization phenomena and the desired traits in the selected plants, including genotypic and phenotypic differences developed by mutational induction are attained at a dosage of 50% mortality and growth diminution in plants, where the possibility of viable and beneficial mutants for crop development is extortionate [3]

Marigold (*T. erecta L.*), an eminent flower crop universally acknowledged for its bright and delightful appearance, belongs to the Asteraceae family and has a spectrum of pharmacological properties. Nevertheless, it is perceived as an ornamental plant and has been a cornerstone for mutational induction because it is less liable to cross pollination with heterozygous genotypes. India contributes around 75-80 percent of worldwide marigold output, which is estimated to be over 6 lakh tons annually. The southern half of the country produces the most marigold; Andhra Pradesh, Uttar Pradesh, and Tamil Nadu are the top marigold producing states in India, followed by Maharashtra, Orissa, Karnataka, Uttar Pradesh, and Kerala. In Tamil Nadu, Erode is the largest marigold producer and key trade centre in India. Many researchers recently reported putative mutants in marigolds on a wide scale. Unfortunately, combined mutagen treatment remains imperceptible. The investigation employing gamma rays resulted in the maximum decrement in plant characters, whilst the lowest 10 KR revealed the constant endeavour in the development and yield of diverse marigold varieties[4]. In contrast to physical mutagens, chemical mutagen (EMS) revealed 30 mM as the lethal dose and with an upsurge in doses, the plants survival was exacerbated [2]. Thus, left an unsubstantiated study over combined treatment in this plant and this work offers one of the first investigations in *T. erecta* using the combined mutagen treatment using gamma ray and EMS.

Gamma rays and EMS are the most frequent and potent mutagens employed in many studies due to their unique characteristics, making them one of the effective mutagens in the arsenal. Random DNA damage is caused by high penetrative ionizing gamma radiation with Relative Biological Effectiveness, whereas single gene mutation is caused by EMS, the alkylating agent, which produce Guanine and Cytosine alkylation. When compared to solitary treatments, combining mutagens may cause a hasty anomaly amid chromosomal dissociation resulting in improved polygenic characteristics. Therefore, the combination of gamma rays and EMS were used in this experiment and the initial step in the mutation breeding process is to obtain the LD<sub>50</sub> value viz germination percentage, which is valuably estimated in this study.

**MATERIALS AND METHODS**

The experiment was carried out in the Cytogenetic and Plant Breeding laboratory, Annamalai University. For this experiment, healthy and homogenous marigold seeds were used. The treatment involves a combination of gamma rays and EMS as the physical and chemical mutagens. The seeds were irradiated with the following doses 10 KR, 20 KR, 30 KR, 40 KR and 50 KR of gamma rays (source <sup>60</sup>Co) at Indira Gandhi Centre for Atomic Research (IGCAR), Kalpakkam. On the contrary, five sequential concentrations of 10 mM, 20 mM, 30 mM, 40 mM and 50 mM Ethyl methanesulfonate in 100 ml of distilled water were individually prepared. At room temperature for 12 hours, the irradiated seeds were submerged in the freshly prepared EMS solution. Following the treatment, the seeds have been rinsed in distilled water thoroughly 10-12 times to eliminate any chemical residues. Therefore, five treatment and a control were evaluated: 0 (Control), 10 KR + 10 mM, 20 KR + 20 mM, 30 KR + 30 mM, 40 KR + 40 mM and 50 KR + 50 mM.





### Aravind S and Dhanavel D

For germination investigations, the treated and the controlled seeds were placed on 90 mm Petri plates with a filter paper and cotton sandwich. The water was utilized to keep moisturize at the beginning and a minuscule amount of water was sprayed when needed during the test. The variables evaluated on the 7<sup>th</sup> day were Germination Percentage, Germination speed index, Shoot length (cm), Root length (cm), Seed vigor. The seedlings were allowed to grow after the 7<sup>th</sup> day to the 30<sup>th</sup> day to obtain survival percentage.

The following equations are used for the estimation of

$$GP = \sum n_i/T \times 100$$

Where, GP = Germination Percentage, n = no. of seeds germinated, T= Total of seeds.

$$GSI = \sum n_i/t$$

Where, GSI = Germination Speed Index, n<sub>i</sub> = no. of seeds germinated day<sup>-1</sup>, t = Days of Germination.

$$SP = \sum n_i/T \times 100$$

Where, SP = Survival Percentage, n = no. of seeds survived, T= Total of seeds germinated.

$$SVI = GP \times SH$$

Where, SVI = Seed Vigor Index, GP = Germination Percentage, SL = Seedling Height

The analyzed data were procured in table (1 & 2) and the LD<sub>50</sub> value was estimated using the analysis based on germination percentage.

## RESULT AND DISCUSSION

The ensuing table 1 shows that the control plant had 94% seed germination, while the lowest treatment at 10 KR + 10 mM had 78 percent, which was comparatively high in comparison to the highest treatment at 50 KR + 50 mM, which had only 6%. The same experiments that used sequential treatment of specifically gamma rays as a physical mutagen and EMS as chemical mutagen produced significantly better results in Marigold [2,5] whereas the germination was severely reduced in combined treatment due to the effect of combined mutagens which amplified the rate of mutation peculiarly. As a result, the cellular crucial metabolism may have been impeded, affecting the cells' meristematic tissues.

GSI was preferably monitored to verify the rate of seed germinated each day, and according to the statement, the GSI for control plants was 12.02 %, but the progressive reduction with escalating treatment depicts the reverberation of the cellular components that directly absorbed the mutagens by the exposed cells (Table 2.). However, the germination percentage was incongruent with the combined treatment of mutagens, despite similar findings being reported in prior studies in *Hibiscus sabdariffa*[6], *Andrographis paniculata*[7], little millet [8] and *Cajanus cajan*[9]. The LD<sub>50</sub> value of combined treatment using gamma rays and EMS in *T. erecta* was fixed at 20 KR + 20 mM by observing 50 % lethality (Table 1). The LD<sub>50</sub>, in particular, is predicated on the premise that they produce limited genome effects at lower doses of mutagens that seldom induce phenotypical alterations, but higher doses may produce substantial genome effects that frequently lead to aberrations or abnormalities.

In comparison to control plants, the seedling height decreased gradually as the treatment level increased (Table 2). When comparing the lowest combined treatment of 10 KR + 10 mM (8.32 cm) to the highest combined treatment of 50 KR + 50 mM, there was a significant difference in seedling height (02.49 cm). It is indeed possible that minor changes in protein function are causing a massive reduction in seedling height. As a result, the vigor index was impregnably shown to have decreased to the minimal, when compared to control. In contrast, to control plants, which had a survival rate of 98.47 percent, the combined treatment employing gamma rays and EMS had the lowest survival rate (21.12) at 50 KR + 50 mM on the 30<sup>th</sup> day (Table 2). The survival deduction can be explained by the diminishing amount of protein and chlorophyll content which eventually affects plant metabolism and results in maximal seedling death.



**Aravind S and Dhanavel D**

## CONCLUSION

These findings show that the fatal dosage was delineated at 20 KR + 20 mM adopting combined mutagenesis (gamma rays and EMS), and the study offers the first step in combined mutagenesis in African Marigold. Increased doses/conc. of mutagens hindered seed germination, seedling growth, and seedling survival, according to the evidence given here. It also advocates employing the optimum doses/conc. to obtain new genetic variation in flowering crop expansion. Future scientific investigations should look at the potential repercussions of combined mutagenesis in African Marigold.

## ACKNOWLEDGMENT

We thank the Department of Botany, Annamalai University for providing necessary facilities to carry out our research and I am also very grateful to Indira Gandhi Centre for Atomic Research (IGCAR), Kalpakkam for giving us permission for gamma irradiation treatment.

## REFERENCES

1. R Amin, M R Wani, A Raina, S. Khurshed. and S. Khan. Induced Morphological and Chromosomal Diversity in the Mutagenized Population of Black Cumin (*Nigella sativa* L.) Ethyl Methane Sulphonate. *Jordan Journal of Biological Sciences*, 2019; 12(1), 23–30.
2. S Aravind and D Dhanavel. Induced physical and chemical mutagenesis on Marigold (*Tagetes erecta* L.) to determine the lethality, germination and seedling survivability. *International Journal of Botany Studies*, 2021;6(3), 235-237.
3. A Alvarez-Holguín, C R Morales-Nieto, C HAvendaño-Arrazate, R Corrales-Lerma, F Villarreal-Guerrero, ESantellano-Estrada. andY Gómez-Simuta. Mean lethal dose (LD50) and growth reduction (GR50) due to gamma radiation in Wilman lovegrass (*Eragrostis superba*). *Revista Mexicana De CienciasPecuarías*, 2019; 10(1), 227–238.
4. V N Singh, B K Banerji, A K Dwivedi, and A K Verma. Effect of gamma irradiation on African marigold (*Tagetes erecta* L.) cv. PusaNarangiGainda. *J. Hortl. Sci.* 2010;4(1), 36–40.
5. S Latha, and P R Dharmatti. Gamma Rays Induced Mutation Studies in Marigold Cv . Double Orange in M 1 Generation. *Int. J. Pure App. Biosci.* 2018; 6(3), 443–447.
6. D Priyanka and D Dhanavel. Physical and Chemical Mutagenesis in Hibiscus sabdariffa L . to Induce Variability on Seed germination, *Survival and Lethal Dose. Indian Journal of Natural Science.* 2021; 12(6), 32280-32284.
7. S Kasthuri and D Dhanavel. Determination of LD50, seed germination, morphological mutants for induced mutagenesis through gamma radiation *Andrographis paniculata* (Burm. F.) nees. *Plant Archives*, 2020; 20(1), 2233–2237.
8. R Ramkumar and D Dhanavel. Effect of Ethyl Methane Sulphonate (EMS) on Germination Behaviour and Seedling Survival of *Panicum sumatrense* Roth Ex Roemers and Schultz. *Journal of the Gujarat Research Society*, 2021; 21(15), 160–164.
9. M Ariraman, S Gnanamurthy, D Dhanavel, T Bharathi and SMurugan. Mutagenic Effect on Seed Germination, Seedling Growth and Seedling Survival of Pigeon Pea (*Cajanus cajan* (L.) Millsp). *International Letters of Natural Sciences*, 2014; 21, 41–49.





**Aravind S and Dhanavel D**

**Table 1: Determination of Germination Percentage (GP) and LD<sub>50</sub> values for Combined Treatment in *T. erecta*.**

Combined Treatment (Gamma rays + EMS)	G P (%)	Percent Over Control (%)	Percent of reduction over control
Control	94	100	0
10 KR +10 mM	78	82.98	17.03
20 KR + 20 mM	52	55.31	44.69
30 KR + 30 mM	34	36.17	63.83
40 KR + 40 mM	18	19.14	80.86
50 KR + 50 mM	6	6.38	93.62

**Table 2: Determination of Germination Speed Index (GSI), Seedling height (SH), Vigor index (VI) and Survival Percentage (SP) for Combined Mutagenesis in *T. erecta*.**

Combined Treatment (Gamma rays + EMS)	GSI (%)	S H (cm)	VI (%)	S P (%)
Control	12.02	11.44 ± 0.36	1073.48	98.47
10 KR +10 mM	7.26	08.32 ± 0.26	648.96	91.65
20 KR + 20 mM	4.78	08.21 ± 0.26	426.92	80.32
30 KR + 30 mM	1.68	05.40 ± 0.17	183.6	69.02
40 KR + 40 mM	1.68	04.88 ± 0.15	86.4	42.24
50 KR + 50 mM	0.50	02.49 ± 0.08	14.94	21.12





## Ant Colony Optimization with Genetic Algorithm (ACO-GA) Approach for Network Lifetime Maximization in Heterogeneous Wireless Sensor Networks (HWSNs)

P.V.Ravindranath\*

Assistant Professor, School of Computer Studies, Rathnavel Subramaniam College of Arts and Science, Sulur, Coimbatore, Tamilnadu, India.

Received: 12 Nov 2021

Revised: 21 Dec 2021

Accepted: 11 Jan 2022

### \*Address for Correspondence

**P.V.Ravindranath**

Assistant Professor, School of Computer Studies,  
Rathnavel Subramaniam College of Arts and Science,  
Sulur, Coimbatore, Tamilnadu, India  
Email : ravindranath@rvsgroup.com



This is an Open Access Journal / article distributed under the terms of the **Creative Commons Attribution License** (CC BY-NC-ND 3.0) which permits unrestricted use, distribution, and reproduction in any medium, provided the original work is properly cited. All rights reserved.

### ABSTRACT

Maximizing Network Lifetime is an essential metric in terms of providing the system designer with knowledgeable decisions for the sake of maintaining the Quality of Service(QoS) and the desired network performance in WSNs. While few methods are there to address the problem in homogeneous WSNs, research on this problem has improved at a slow pace. Ant Colony Optimization with Genetic Algorithm (ACO-GA) approach is proposed for Maximizing the Number of Connected Covers (MNCC). At first, transform the search space of the problem into a construction graph. Every vertex in the graph denotes a task of a tool in a subset. Pheromone is to set every two devices to record the historical appeal of assigning them to the same subset. While in every iteration, the number of subsets is adaptively determined as one plus the number of connected covers in the finest solution. GA is used to produce a set of non-dominated solutions that store the refinements of the solutions by reassigning redundantly connected cover. The outcome shows that the ACO-GA-MNCC approach is effective and competent in finding high-quality solutions for maximizing the lifetime of heterogeneous WSNs.

**Keywords:** Index Term: Ant Colony Optimization (ACO), Genetic Algorithm (GA), Connectivity, Coverage, Network Lifetime, Maximizing the Number of Connected Covers (MNCC), and Wireless Sensor Networks (WSNs).



**Ravindranath****INTRODUCTION**

Wireless Sensor Networks (WSNs) are self-organized sensor nodes, which maintain inadequate power, computational capabilities, and bandwidth [1]. WSN is an optimistic technology that recommends a high-quality solution for the design and development of real-time applications using traditional networking paradigms [2]. Each sensor node contains a battery, a microcontroller, memory, and also a transceiver, whereas the sink node collects data for processing and decision-making. The sensor node monitors collect data and send information to an allocated area. The sensor nodes have to operate in partial energy resources to provide support for applications [3]. However, batteries acquire a finite energy capacity, and this limitation has generated significant interest concerned with the use of many aspects of WSNs to increase battery life by selecting the best possible paths with effective power management to maximize operational lifetime. Maximize Network Lifetime is an essential metric in terms of endowment that the system designer with well-informed decisions for the sake of preserving the desired network performance and the Quality of Service(QoS) in WSNs, where the sensor nodes usually rely on inadequate battery capacity unless they encompass direct mains supply. Moreover, insensible applications, refilling the battery energy of the sensors, or replacing the sensors are typically impractical. Therefore, the NL is limited by the battery of the individual sensors in the WSN considered. However, the definition of NL might vary depending upon the specific application, on the objective function, and on the network topology considered. Specifically, the authors of [4], [5], and [6] defined the running out of the NL as the time instantaneous at which a definite number of nodes in the network at a low level their batteries. For example, the NL was well-defined in [7] as the lifetime of the particular sensor node related with the highest energy consumption rate, whereas the authors of [8], [9], and [10] well-thought-out the lifetime of the network to be run out at the fastidious instant when the first node's battery was at a low level. Therefore, the network's lifetime is one of the most important design factors in WSNs, since all the design objectives can only be met if the network is operational. Additionally, in realistic applications, for example in the case of sensors embedded into the glaciers to measure the climate changes, replenishing the battery energy of the sensors and/or replacing the sensors are usually not possible and/or costly. Therefore, the NL is limited by the battery of the individual sensors in the WSN. Hence, [11] proposed an adaptive scheme for striking a compelling trade-off among the possible transmit rate and the power dissolute. In [12] they observed a fixed rate system considering the impact of various physical layer parameters on the NL, together with the signal processing power degenerate by each sensor. These methods will not be best suitable for heterogeneous WSN.

During the improvement of the network lifetime at every point, the active devices must custom a connected cover for satisfying sensing coverage and network connectivity. Several methods were already proposed for the result of one absolute connected cover from a WSN, however the connected cover attained potentially finest under certain criteria, such as minimum size [13], [14], or minimum energy consumption [15], [16]. However, producing a sequence of optimally connected covers by reiterating the above methods may not lead to network lifetime maximization. The finest and direct way of maximizing the network lifetime is increasing the quantity of connected covers. The issue is retrieving the maximum number of connected covers is extremely complicated because each connected cover has to carry out sensing coverage and network connectivity simultaneously. The problem of maximizing the number of subsets that accomplish sensing coverage is already in the non-deterministic polynomial-time (NP-complete) complexity class [17]. Zhao et al [18] proposed a greedy algorithm that deals with both sensing coverage and network connectivity, but the algorithm can only handle the coverage of discrete points. It is also complicated to extend the algorithm to heterogeneous WSNs that consist of different types of devices. In this work, a common type of heterogeneous WSNs is considered and a novel activity planning approach is also proposed for maximizing the network lifetime. The approach can be utilized in both cases of discrete point coverage and area coverage. Ant Colony Optimization with Genetic Algorithm (ACO-GA) approach is proposed for Maximizing the Number of Connected Covers (MNCC). The ants consequently focus on discovering one additional connected cover and avoid constructing subsets excessively. GA is used to produce a set of non-dominated solutions that store the refinements of the solutions by reassigning redundantly connected covers. Experimental outcomes validate the effectiveness and competence of the proposed ACO-GA-MNCC approach.





### Ravindranath

#### Literature Review

Wang et al [19] investigated a joint optimal design of the physical, Medium Access Control (MAC) and routing layers to maximize the network lifetime of a Multiple-Sources and Single-Sink (MSSS) WSN with energy constraints. The Network Lifetime Maximization (NLM) problem can be expressed as assorted integer-convex optimization problem with the implementation of the Time Division Multiple Access (TDMA) technique. Provide an analytical framework for the comfortable NLM problem of a WSN in a common planar topology. The planar networks on a small scale, initially limits the topologies, including triangle and regular quadrangle topologies. In this different case, make use of the Karush-Kuhn-Tucker (KKT) optimality clauses to attain analytical expressions of the worldwide finest NL, which obtain the influence of data rate, link access, and routing into account. Numerical results exemplify the proposed algorithm can be extended to the large planar case and its performance is close to globally optimal performance. In et al [20] proposed an Ant Colony Optimization (ACO) approach that can maximize the lifetime of heterogeneous WSNs. The methodology is to find the maximum number of disjoint connected covers that assure both sensing coverage and network connectivity. A construction graph is designed with each vertex representing the assignment of a device in a subset. In the pheromone and heuristic information, the ants look for the best possible path on the construction graph to maximize the number of connected covers. The proposed approach applied to a different form of heterogeneous WSNs. The results show that the approach is effective and capable of finding high-quality solutions for maximizing the lifetime of heterogeneous WSNs.

Kumar and Thomas [21] proposed a data collection scheme, called the Maximum Amount Shortest Path (MASP), to address this issue that increases network throughput as well as conserves energy by optimizing the assignment of sensor nodes. MASP is proposed as an integer linear programming problem and then solved with the help of improved ant colony optimization. The enduring energy of each node is considered and the best possible path is selected because of the shortest path, residual energy, channel noise, and delay. This approach is validated through simulation experiments using Network Simulator 2(NS2). Peng et al [22] presented an Intra-route and Inter-route Coordination (I2C) holistic approach to prolong the sensor network lifetime under the end-to-end delivery delay constraint. I2C is collected of two-lifetime balancing modules: (i) the Intra Route Coordination module that allocates the nodes on the same route to a sense of balance their nodal lifetimes from beginning to end adjusting the MAC behaviors collaboratively; (ii) the Inter-Route Coordination module that reliability the nodal lifetimes across altered routes via adjusting the communication routes. I2C is capable of extending the network lifetime much more effectively than the state-of-the-art solutions while guaranteeing the desired delay bound and maintaining a similar level of network power consumption

#### Proposed Methodology

Ant Colony Optimization with Genetic Algorithm (ACO-GA) approach is proposed for Maximizing the Number of Connected Covers (MNCC). At first, transforms the search space of the problem into a construction graph. Each vertex in the graph indicates a task of a tool in a subset. Among every two devices the pheromone is located to record the sequential desirability of allocating them to the same subset. While in every iteration, the number of subsets is adaptively resolute as one plus the set of connected covers in the finest solution. GA is used to produce a set of non-dominated solutions that store the refinements of the solutions by reassigning redundantly connected cover. Hence, to attain the upper bound of the number of connected covers, the maximum number of full cover subsets can be utilized.

#### Problem Formulation

In this section, the difficulty of discovering the maximum number of disjoint connected covers is defined. Also, In a WSN a method acquaint with evaluating an upper bound of the number of connected covers. Define a solution to the problem as  $Sl = \{Sl_1, Sl_2, \dots, Sl_N\}$  where  $Sl_i \subseteq SEN \cup SIN$  denotes a subset composed of  $A_i$  sensors and  $B_i$  sinks,  $i = 1, 2, \dots, N$ .  $N$  be present the number of subsets. Each subset is disjoint with the others and the union of the  $N$  subsets equals the set of  $SEN \cup SIN$ . Three criteria are designed to evaluate each subset's satisfaction with the three constraints. The criterion for the Coverage Constraint: The coverage percentage achieved by the sensors in  $S_i$  can be





**Ravindranath**

directly used as the criterion for the coverage constraint. If the target is a group of isolated points, the coverage percentage is the number of covered points. If the target is an area, the coverage percentage can be calculated based on the idea of fields. This paper uses area coverage as a study case and the coverage percentage  $\kappa_i$  is the ratio of the number of covered fields to the number of existing fields, i.e

$$\kappa_i = \frac{|\cup_{SE_j \in S_i} F_j|}{|F|}$$

where  $F_j \subseteq F$  denotes the set of fields covered by a sensor  $SE_j \in S_i, i = 1, 2, \dots, N$ .

The measure for the Collection Constraint: In any case a sensor with one sink node must be present in the transmission range as a collected sensor. A subset with a larger number of collected sensors can enhance the assurance of the collection constraint. The proportion of  $\chi_i$  of collected sensors in  $S_i$  can be employed as the criterion, i.e.,

$$\chi_i = \frac{H_i}{U_i}$$

where  $H_i$  is the number of collected sensors in  $S_i$ .

The measure for the Routing Constraint: Consider a communication graph  $G_i$ , where the  $V_i$  sinks in  $S_i$  compose the vertex set, and the edge set is  $\{(S_{I_j}, S_{I_k}): ||S_{I_j} - S_{I_k}|| \leq R_t, S_{I_j}, S_{I_k} \in S_i, j \neq k\}$ . The sinks in  $S_i$  constitute a connected network if and only if  $G_i$  is a connected graph. Based on the graph theory, the connectivity of a graph can be measured by the relative size  $\lambda_i$  of its largest connected subgraph [26]. The criterion for the routing constraint is defined as

$$\lambda_i = \frac{B_i}{V_i}$$

where  $B_i$  is the number of sinks in the largest connected subgraph of  $G_i$ . The values of the above criteria are all in the range of [0,1]. A larger value indicates a smaller violation of the constraint. Use the average value of the three criteria,  $(\kappa_i + \chi_i + \lambda_i)/3$ , to review adequately the set  $S_i$  satisfies the three constraints. If the outcome average value equals one, i.e.,  $\kappa_i = \chi_i = \lambda_i = 1$ ,  $S_i$  satisfies all three constraints and set to a connected cover. Later applying the three criteria to measure the entire  $N$  subsets, the objective value of the solution  $S$  can be calculated as

$$\Phi(S) = \omega_1 \sum_{i=1}^N (\kappa_i + \chi_i + \lambda_i)/3 + \omega_2 C$$

where  $\omega_1, \omega_2 > 0$  are predefined weights, and  $C$  is the number of connected covers in  $S$ .

It can be experiential that the objective function has two components. The first module summarizes the constraint violations of all the subsets. The second module awards the objective value derived from the number of connected covers. Since the goal of ACO-GA- MNCC is to find a solution that maximizes the number of connected covers, the objective value should grow as  $C$  increases. For ensuring this, the values of  $\omega_1$  and  $\omega_2$  need to satisfy

$$\frac{\omega_2}{\omega_1} \geq \hat{C}$$

The heuristic information in ACO-GA-MNCC is associated with each device assignment for measuring the improvement that the device can bring to the subset. The sensors directly control the coverage of the target area; the heuristic information for the sensors as a result based on the increasing the percentage in the coverage. The sinks involve the destruction of the collection constraint. The heuristic information for the sinks is, consequently, related to the change in the proportion of collected sensors. Mathematically, the heuristic value for assigning an unassigned device  $J$  to a subset  $S_i (i = 1, 2, \dots, N_t)$  can be formulated as







**Ravindranath**

$$\eta_i(J) = \{k_i' - k_i, \text{if } J \text{ is a sensor}; \chi_i' - \square_i, \text{if } J \text{ is a sink.}$$

where  $k_i'$  and  $\chi_i'$  denote the coverage percentage and the proportion of collected sensors after  $J$  joins  $S_i$ . This way, the heuristic information biases the ants to select the subsets wherein the devices are further helpful for reducing constraint violations. Ant Colony Optimization (ACO) is one of the population-based metaheuristic techniques based on the foraging behavior of real ants. They seek food and create the shortest paths from their nest to the food source. Ant colony optimization is a group of algorithms that create solutions based on the problem data and has been obtainable for application to discrete optimization problems. In reality, ants hunt for food bases in a random way. The moment an ant discovers a food source, they will carries few food and returns to their colony. Although they move all along the paths, they lay a chemical substance called pheromone as they pass through. In turn, shorter paths will have a higher rate of pheromone trails. All ants make decisions by using pheromone trails as a communication mechanism. The potency of the pheromone trail deposited on the ground depends on the quality of the solution (food source) found. Pheromone trails accrue with multiple ants in shorter paths, which source a higher density than longer paths, accordingly increasing its attractiveness. All pheromone trails are in the long run reduced by an evaporation rate. At the same time, a process of evaporation presents the exploration and prevents halt at a local minimum. However, the pheromone values are simplified at the end of entire iteration.

$$Pr_{ij}^k = \left\{ \frac{(\square_{ij})^\alpha (\eta_{ij})^\alpha}{\sum_{m \in N_i^k} (\tau_{im})^\alpha (\eta_{im})^\alpha} \right. j \in N_i^k \text{ else } (1)$$

where  $Pr_{ij}^k$  is the probability which ant  $k$  chooses to move from node  $i$  to node  $j$ . These results depend on the pheromone level and heuristic information. While  $N_i^k$  is the set of feasible neighborhoods that have not yet been visited by ant  $k$ ,  $g_{ij}$  is a heuristic function,  $s_{ij}$  is the amount of pheromone on edge  $i$  and  $j$ , and  $\alpha$  and  $\beta$  are the parameters that determine the relative importance of pheromone concentration and heuristic information. The pheromone modification can be formed as follows:

$$\tau_{ij} \leftarrow \tau_{ij} + \Delta \square_{ij}^k (2)$$

$$\Delta \square_{ij}^k = \left\{ \frac{Q}{f(\psi^k)} \right. l_{ij} \in \psi^k \text{ else } (3)$$

The evaporation update is given by:

$$\tau_{ij} \leftarrow (1 - \rho) \tau_{ij} (4)$$

where  $\rho$  is the constant factor reduction of all pheromones,  $f(\psi^k)$  is the cost of the solution performed by ant  $k$ , and  $Q$  is a constant. The above optimization process is completed after a certain computation of iteration. A genetic algorithm is an intelligent probabilistic search algorithm to facilitate the replication of the method of evolution by taking a population of solutions and applying genetic operators in every single reproduction. All solutions in the population are accorded a fitness value by evaluating it according to a few performance measures. The population is operated on by three main genetic operators: reproduction, crossover, and mutation. In a process of reproduction in which the individual strings are copied based on their fitness values, the results in more highly suitable chromosomes and less weak chromosomes in the intermediate mating pool. During the crossover operation, the chromosomes used for mating are selected through the roulette wheel selection strategy. The mutation is practiced to avoid the solution from getting stuck in a local optimum. The generation in GA terminology is the one cycle of genetic operations along with the evaluation procedure. The sequence of reproduction – crossover – mutation selection is continued until the termination criterion is met. Apart from the above-described structure of a conventional GA, other techniques such as elitism, local neighborhood search, and increased mutation incidence are used in the present work to produce comparatively better results.





## SIMULATION RESULTS

In this section experimentation work is performed to evaluate the outcome of ACO-GA-MNCC, ACO-MNCC, along with the Energy-efficient Distributed Target Coverage (EDTC) algorithm. Since the proposed ACO-GA-MNCC is the first algorithm intended to maximize the number of connected covers in heterogeneous WSNs. For experimentation tasks, choose MATLAB as the simulation tool. Three sets of heterogeneous WSNs utilizing different scales and redundancy are working in the experiments. In Set A, WSNs are created via randomly deploying sensors and sinks in a  $50 \times 50$  rectangle. Table 1 defines the settings of these networks, including the scale  $|SEN|$  and  $|SIN|$ ,  $r_s$ , and  $r_t$  of sensors,  $R_i$  of sinks, and the upper bound  $\hat{C}$  of the number of connected covers. In the subsequent study, determination shows that ACO-GA-MNCC and ACO-MNCC are capable to discover a solution utilizing  $\hat{C}$ -connected covers for each case. Consequently, the value of  $\hat{C}$  is the maximum number of connected covers for each case in Set A. Three different parameters have been used in this work for comparing different algorithms in WSNs. These are given as follows:

**Network Lifetime:** The time of each node in the network running out of energy and what will be the solutions to increase the lifetime of a network.

**Success Ratio:** To determine the success ratio of sending the packets from the source node to the destination node in the network.

**Packet Loss Ratio (PLR):** The ratio of packets successfully received from the total packets sent. Throughput is the rate at which information is transferred through the network.

**Average Energy Consumption:** The average energy consumption of every node in the specified area for transmitting a data packet to the nearest sink node.

### Network Lifetime

Figure 2 shows the results of network lifetime are measured by varying the number of sensor nodes between 20 and 100. From the simulation results, it concludes that the proposed ACO-GA-MNCC produces a higher network lifetime value of 56 ms whereas other existing methods produce lesser network lifetime values are 38 ms, 40 ms compared to EDTC, ACO-MNCC methods respectively and discussed in table 2.

### Success Ratio

Figure 3 shows the performance comparison results of the success ratio in terms of several nodes. From the results, it concludes that the proposed ACO-GA-MNCC produces higher success ratio results of 96% whereas other existing methods produce lesser success ratio values are 50%, 60% compared to EDTC, and ACO-MNCC methods correspondingly. As a result, ACO-GA-MNCC is more suitable and gives the best results for improving the success ratio. It demonstrated that if the count of nodes increases the success ratio of the proposed ACO-GA-MNCC system is also increased (shown in Figure 3 and see table 3).

### Packet Loss Ratio (PLR)

Figure 4 shows the performance comparison results of the Packet Loss Ratio (PLR) in terms of several nodes. From the results, it demonstrated that the proposed ACO-GA-MNCC algorithm produces lesser PLR results of 10% which is 45%, 35% higher when compared to EDTC, ACO-MNCC methods correspondingly. It demonstrated that the proposed algorithm works better when compared to other methods. It is demonstrated that if the no of nodes increases the outcome of the proposed ACO-GA-MNCC algorithm system also increases, on the other hand, it decreases when compared to other existing methods (shown in Figure 4 and Table 4).



**Ravindranath****Energy Consumption**

Figure 5 shows the performance comparison outcome of energy consumption in terms of the count of nodes. From the results, it demonstrated that the proposed ACO-GA-MNCC consumes lesser energy results of 730 J whereas other existing methods consume higher energy results are 1086J, 940J compared to EDTC, and ACO-MNCC methods correspondingly. It demonstrated that the proposed ACO-GA-MNCC works better when compared to other methods (see table 5).

**CONCLUSION AND FUTURE WORK**

Ant Colony Optimization with Genetic Algorithm (ACO-GA) approach is proposed for Maximizing the Number of Connected Covers (MNCC). The ants thus consider finding another connected cover and avoid constructing subsets excessively. It first transforms the search space of the problem into a construction graph. Each vertex in the graph denotes an assignment of a tool during a subset. Pheromone is deposited between every two devices to record the historical desirability of assigning them to an equivalent subset. In every iteration, the number of subsets is determined to increase the number of connected covers within the finest solution. GA is utilized to outline a set of non-dominated solutions that stores the improvements of the solutions by reallocating redundantly connected cover. As a result, the maximum number of fullycovered subsets can be utilized as the upper bound of the number of connected covers. Experimental outcomes validate the effectiveness and competence of the proposed ACO-GA-MNCC approach. The results conclude that the proposed algorithm provides higher results in terms of network lifetime; packet loss ratio reduces energy usage and lesser loss ratio. In future work, the current system is extended to a real-time WSN model. The WSN environment is applied to other recent optimization methods.

**REFERENCES**

1. A.V. Sutagundar, S.S. Manvi, and K.B. Balavalad, Energy-efficient multipath routing protocol for WMSNs, International Journal of Computer and Electrical Engineering, Vol.2, No.3, Pp.503-510, 2010.
2. K. Nellore and G.P. Hancke, A survey on urban traffic management systems using wireless sensor networks, Sensors, Vol.16, No.2, Pp.157-182, 2016.
3. Z. Chen, Y. Peng and W. Yue, Model-checking driven design of QoS-based routing protocol for wireless sensor networks, Journal of Sensors, Pp.1-7, 2015.
4. J. Chen, J. Li, and T. Lai Trapping mobile targets in wireless sensor networks: An energy-efficient perspective, IEEE Transactions on Vehicular Technology, Vol.62, No.7, Pp.3287–3300, 2013.
5. M. Najimi, A. Ebrahimzadeh, S. Andargoli, and A. Fallahi, Lifetime maximization in cognitive sensor networks based on the node selection, IEEE Sensors Journal, Vol.14, No.7, Pp.2376–2383, 2014.
6. J. Du, K. Wang, H. Liu, and D. Guo, Maximizing the lifetime of k-discrete barrier coverage using mobile sensors, IEEE Sensors Journal, Vol.13, No.12, Pp.4690–4701, 2013.
7. H. Salarian, K. Chin and F. Naghdy, An energy-efficient mobile-sink path selection strategy for wireless sensor networks, IEEE Transactions on Vehicular Technology, Vol.63, No.5, Pp.2407–2419, 2014.
8. J.W. Jung and M. Weitnauer, On using cooperative routing for lifetime optimization of multi-hop wireless sensor networks: Analysis and guidelines, IEEE Transactions on Communications, Vol.61, No.8, Pp.3413–3423, 2013.
9. Y. Chen and Q. Zhao, On the lifetime of wireless sensor networks, IEEE Communications Letters, Vol.9, No.11, Pp.976–978, 2005.
10. C. Cassandra, T. Wang, and S. Pourazarm, Optimal routing and energy allocation for lifetime maximization of wireless sensor networks with nonideal batteries, IEEE Transactions on Control of Network Systems, Vol.1, No.1, Pp.86–98, 2014
11. H. Yetgin, K.T.K. Cheung, M. El-Hajjar and L. Hanzo, Cross-layer network lifetime maximization in interference-limited WSNs, IEEE Transactions on Vehicular Technology, Vol.64, No.8, Pp.3795–3803, 2015.





### Ravindranath

12. H. Yetgin, K.T.K. Cheung, M. El-Hajjar and L. Hanzo, Cross-layer network lifetime optimization considering transmit and signal processing power in wireless sensor networks, *IET Wireless Sensor Systems*, Vol.4, No.4, Pp.176–182, 2014.
13. Boukerche, X. Fei and R.B. Araujo, An optimal coverage-preserving scheme for wireless sensor networks based on local information exchange, *Computer Communications*, Vol.30, No.14–15, Pp.2708–2720, 2007.
14. 14.S. Funke, A. Kesselman, F. Kuhn, Z. Lotker and M. Segal, Improved approximation for connected sensor cover, *Wireless Networks*, Vol.13, No.2, Pp.153–164, 2007.
15. 15.Chamam and S. Pierre, On the planning of wireless sensor networks: energy-efficient clustering under the joint routing and coverage constraint, *IEEE Transactions on Mobile Computing*, Vol.8, No.8, Pp.1077–1086, 2009.
16. 16.M. Cardei and J. Wu, Energy-efficient coverage problem in a wireless ad-hoc network, *Computer Communications*, Vol.29, No.4, Pp.413–420, 2006.
17. 17.M. Cardei and D.Z. Zhang, Improving wireless sensor network lifetime through power aware organization, *Wireless Networks*, Vol.11, No.3, Pp.333–340, 2005.
18. 18.Q. Zhao and M. Gurusamy, Lifetime maximization for connected target coverage in wireless sensor networks, *IEEE/ACM Transactions on Networking (TON)*, Vol.16, No.6, Pp.1378–1391, 2008.
19. 19.H. Wang, N. Agoulmine, M. Ma, and Y. Jin, Network lifetime optimization in wireless sensor networks, *IEEE Journal on Selected Areas in Communications*, Vol.28, No.7, Pp.1127–1137, 2010.
20. 20.Y. Lin, J. Zhang, H.S.H. Chung, W.H. Ip, Y. Li and Y.H. Shi, An ant colony optimization approach for maximizing the lifetime of heterogeneous wireless sensor networks, *IEEE Transactions on Systems, Man, and Cybernetics, Part C (Applications and Reviews)*, Vol.42, No.3, Pp.408-420, 2011.
21. 21.Kumar and A. Thomas, Energy efficiency and network lifetime maximization in wireless sensor networks using improved ant colony optimization, *Procedia engineering*, Vol.38, Pp.3797-3805, 2012.
22. 22.Y. Peng, Z. Li, D. Qiao, and W. Zhang, I<sup>2</sup>C: A holistic approach to prolong the sensor network lifetime, *IEEE International Conference on Computer Communications (INFOCOM'13)*, Pp. 2670–2678, 2013.

**Table 1: Test Cases**

No	SEN	SIN	No	SEN	SIN	$r_s$	$r_t$	$R_t$	$\hat{C}$
A1	200	100	B1	179	76	10	18	36	6
A2	400	100	B2	295	69	10	20	40	8
A3	400	200	B3	328	154	15	20	40	21
A4	600	100	B4	444	75	8	20	40	8
A5	600	200	B5	496	156	11	18	36	19
A6	800	100	B6	464	60	8	15	30	5
A7	800	200	B7	586	137	10	18	36	16
A8	800	400	B8	639	268	12	18	36	29
A9	1000	100	B9	773	71	5	18	36	6
A10	1000	200	B10	848	147	6	15	30	11
A11	1000	400	B11	883	301	9	16	32	25

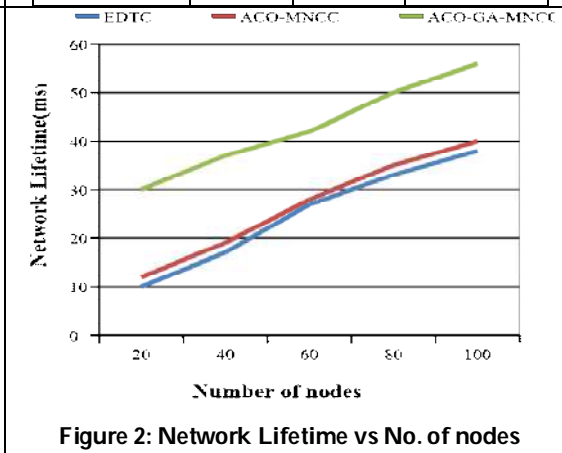
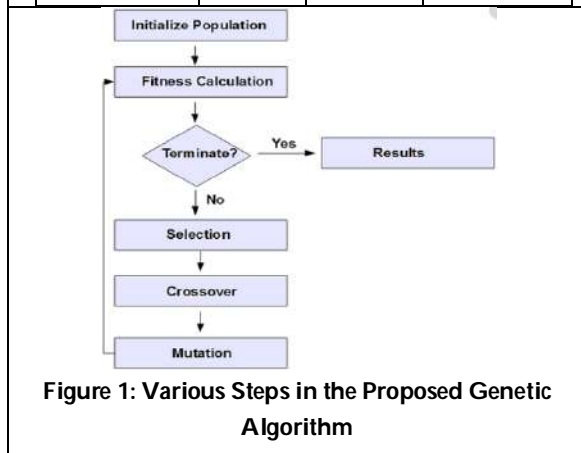




**Ravindranath**

Table 2: Network Lifetime vs. No. of nodes				Table 3: Success Ratio vs. No. of nodes			
No of nodes	Network Lifetime (ms)			No of nodes	Success Ratio (%)		
	EDTC	ACO-MNCC	ACO-GA-MNCC		EDTC	ACO-MNCC	ACO-GA-MNCC
20	10	12	30	20	35	48	82
40	17	19	37	40	40	50	86
60	27	28	42	60	42	53	90
80	33	35	50	80	45	55	92
100	38	40	56	100	50	60	96

Table 4: PLR vs. No. of nodes				Table 5: Energy Consumption vs. No. of nodes			
No of nodes	PLR (%)			No of nodes	Energy Consumption (J)		
	EDTC	ACO-MNCC	ACO-GA-MNCC		EDTC	ACO-MNCC	ACO-GA-MNCC
20	69	55	23	20	891	767	570
40	71	53	18	40	925	820	620
60	62	51	14	60	945	860	660
80	59	50	12	80	995	900	704
100	55	45	10	100	1086	940	730





**Ravindranath**

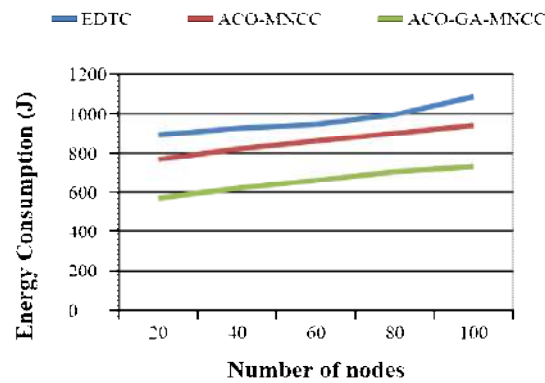
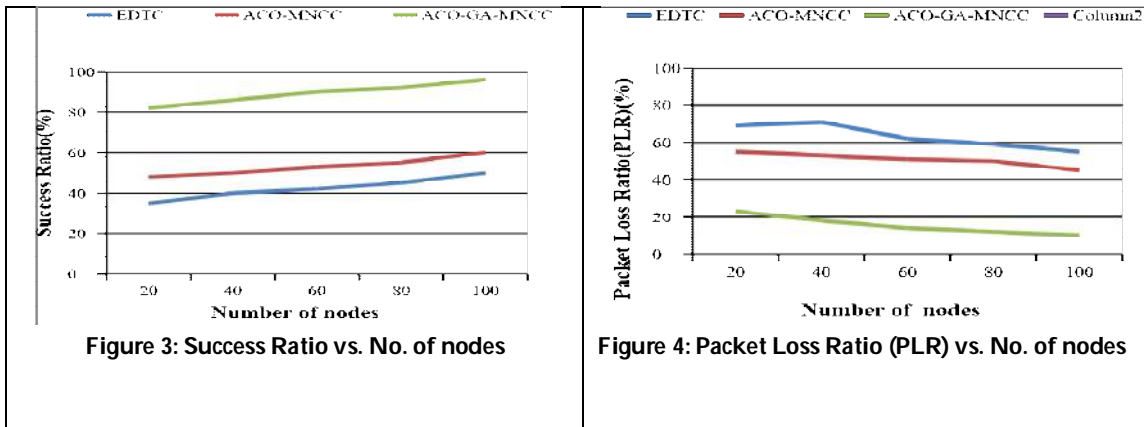


Figure 5: Energy Consumption vs. No. of nodes





## Precursor of Insulated Gate Bipolar Transistor's Failure and its Effect on Power Electronics Module

P.Loganathan<sup>1\*</sup> and P. Selvam<sup>2</sup>

<sup>1</sup>Research Scholar, Assistant Professor, Department of Electrical and Electronics Engineering, Vinayaka Mission's Kirupananda Variyar Engineering College, Vinayaka Mission's Research Foundation (Deemed to be University), Salem, Tamil Nadu, India.

<sup>2</sup>Professor and Head, Department of Electrical and Electronics Engineering, Vinayaka Mission's Kirupananda Variyar Engineering College, Vinayaka Mission's Research Foundation (Deemed to be University), Salem, Tamil Nadu, India.

Received: 22 Nov 2021

Revised: 26 Dec 2021

Accepted: 12 Jan 2022

### \*Address for Correspondence

#### P.Loganathan

Research Scholar, Assistant Professor,  
Department of Electrical and Electronics Engineering,  
Vinayaka Mission's Kirupananda Variyar Engineering College,  
Vinayaka Mission's Research Foundation (Deemed to be University),  
Salem, Tamil Nadu, India.  
Email: loganathan@vmkvec.edu.in



This is an Open Access Journal / article distributed under the terms of the **Creative Commons Attribution License** (CC BY-NC-ND 3.0) which permits unrestricted use, distribution, and reproduction in any medium, provided the original work is properly cited. All rights reserved.

### ABSTRACT

Power Semiconductor Switches are very important devices in the fields of electrical & electronics engineering, automotive engineering, and all types of control applications, such as transmission, transportation drives, process control, and power conversion units in the manufacturing industry. Semiconductors used in power electronics, such as the diode, the Silicon Controlled Rectifier (SCR), the Bipolar Junction Transistor (BJT), the Metal Oxide Semiconductor Field Effect Transistor (MOSFET), the Insulated Gate Bipolar Transistor (IGBT), the Silicon Controlled Switch (SCS), and the Thyristor Controlled Rectifier (TCR), provide reliable control with soft switching under solid state conditions, with the goal of achieving zero loss. The development of body heat in Power Semiconductor devices when switching and managing large amounts of power is the most serious problem. The IGBT is the most significant device in power electronics for transporting large range voltages, currents, and power, although it has problems switching and carrying current due to its high switching resistance. The heat generated by the change in temperature of the IGBT at the junction is a key factor in the failure of the module, as well as the damage it causes to the components and circuitry. Maintenance that is planned based on lifespan prediction and condition monitoring may be able to reduce the occurrence of wear out failures in the field setting. However, the catastrophic failure is difficult to predict and, as a result, it may have major implications in power electronic transformers, which is why it is not recommended. This



**Loganathan and Selvam**

investigation of the failure actions and failure processes of IGBTs is provided in this paper in order to acquire a better knowledge of the catastrophic failure of IGBTs.

**Keywords:** Power Semiconductor Switches, Insulated Gate Bipolar Transistor, Soft Switching, Drives Control, Failure Mechanisms.

## INTRODUCTION

Insulated Gate Bipolar Transistors (IGBTs) are bipolar-metal-oxide semiconductors that offer the benefits of low on-state resistance, voltage control of the gate, and a large safe working region. They are used in a variety of applications. It is a well-known electrical gadget that falls under the category of high-power semiconductor switching device. It provides great efficiency as well as quick switching capabilities, and it is essential in electronic systems, among other things. In particular, IGBTs are used in commercial and industrial applications requiring high voltage and current, such as switching applications in wind turbines, power conversion and transmission in automobiles, high-voltage power supplies in traction, and regulating DC voltage for household appliances [1]. IGBTs are also one of the most crucial components, as well as one of the most extensively utilised power devices, in power electronic systems operating at voltages more than 1 kV and a power output greater than 1 kW. It operates at switching frequencies ranging from 1 kHz to 150 kHz with a current of 1500A, and it operates at temperatures ranging from 100°C to 200°C throughout its switching.

### IGBT STRUCTURE AND CHARACTER

The IGBT has input properties similar to PMOSFETs and output characteristics similar to Power BJTs, and as a result, its sign is a combination of the symbols of the two primary parent devices. Except for the presence of an extra p+ layer, the IGBT's construction is quite similar to that of a vertical diffusion power MOSFET [2]. As shown in Fig. 3, there is an injection layer above the collector terminal, and the other layers are referred to as the drift and the body area. This p+ injection layer is critical to the IGBT's exceptional properties, since it is responsible for injecting the sources of holes into the n region of the body. While the vertical arrangement has certain unique characteristics, the most significant is the formation of a collector-drain area at its bottom; yet, this region is identical to that of a standard MOSFET when using this configuration. The bulk of the carriers in inductively coupled bipolar transistors (IGBTs) are electrons, which conduct current.

When the collector terminal is positive in relation to the emitter terminal, and a sufficient amount of positive is applied to the gate, an inversion layer (i.e., a conductive channel) is formed in the p - region just below the gate oxide, allowing electrons to flow from the emitter terminal to the collector terminal through the conductive channel. Because IGBTs are activated by voltage rather than current, they have higher switching rates when compared to bipolar transistors (BJTs). When a positive voltage is given to the collector while the emitter is at ground, the positive carriers from the p+ layer, which contacts the collector, are injected into the body of the transistor. Conductivity modulation is the process of lowering body resistance while raising carrier concentration, which results in an accumulation of surplus charges in the device's body. When compared to the power MOSFET, the IGBT has a lower on-resistance as a result of its design.

### IGBTS FAILURE PRECURSORS

The failure of IGBTs may be categorised into two types: catastrophic failure and wear out failure, respectively. In most cases, IGBT wear out failure is caused by cumulative deterioration over time, while catastrophic failure is caused by a single-event overstress, such as an excessive voltage or current, or an excessive temperature, among other things. Because of the reasons listed below, IGBTs consistently fail in two important behavioural areas during





**Loganathan and Selvam**

operation with operations. The failure of IGBTs in two primary behavioural areas during operation with applications is caused by the factors listed in the preceding paragraph.

- ✓ Physical behavior (Thermo-Mechanical)
- ✓ Electrical behavior (Thermo-Electrical)

IGBTs are often built and framed with a module for use in high-power applications, such as power distribution. This physical behaviour is subjected to stresses induced by cyclic temperature fluctuations, which are based on structural design [1]. Die attach (fig.5.a) is a mechanical assembly of the device that also serves as an electrical and thermal contact on its backside. Because of the high stress and temperature required for frequent switching and operation of applications, this die attach degrades with time. High temperature, high electric field, and overvoltage, short circuit, loss of gate control, and increased leakage current are the other failure modes for IGBTs. These failure modes are caused by time dependent dielectric breakdown [4,8], as well as short circuit, loss of gate control, and increased leakage current. Thermal fatigue, which is common in bonding wire or solder junctions, may create degradations that can lead to early failures [10], as well as other problems.

**FAILURE MODES**

Open-circuit failure, short-circuit failure, and parameter drift are the three types of catastrophic failure activities that may occur in an IGBT. Typically, open-circuit failure is not considered deadly to transformers since the motor may continue to function at a lesser level of quality. Alternatively, short-circuit failure is virtually lethal to transformers, as the unrestrained short-circuit current may cause the failed IGBT and/or other variables in the circuit to burn up and fail. Figure 6 depicts a classification of IGBT catastrophic failures that may occur.

**OPEN CIRCUIT**

Open circuit fault causes a veritably sluggish change in current for IGBTs, and the faulty switch does not conduct the current when the open circuit failure happens, therefore determining the cause of the open circuit failure is very crucial in this case. IGBTs fail as a result of drive faults that result in power motor failures and a considerable decline in the overall performance of the drive. In addition to DC-link capacitor failures, which account for more than 60 percent of all power transformer-related diversions, IGBT transistor failures account for the great majority of the maturity bones.

**OPEN-CIRCUIT FAILURE MECHANISMS**

Although an IGBT open-circuit failure does not result in the motor failing incontinently, it may result in subsequent failures in other biases and the motor itself. The mechanisms are as follows

**BOND WIRE LIFT-OFF OR RUPTURE**

Bond line lift-off failure may occur as a result of a short-circuit fault. The majority of the time, it is due to mechanical causes. The most important processes are linked to the mismatch of parts of thermal expansion (CTEs) between Silicon and Aluminum, as well as high temperature slants in both materials. Crack propagates from the perimeter of the bonding interface to the weaker core bond region [18], and the bond wire is eventually lifted off when the crack propagates to this weaker location. Central emitter bond wires are often the first to break, with the survivor bond cables following closely after.

**GATE DRIVER FAILURE**

There are a variety of reasons for gate driver failure, including faulty power stage devices (e.g., BJTs or MOSFETs) and unconnected cables between the drive board and the IGBT [19]. Because of the failure of the driver, the IGBT may experience occasional miscarrying, a demoralised affair voltage, and overstressing of the other IGBTs and capacitors. It is also possible that abnormal working circumstances in IGBT power outstations will result in a motorist failure. Continued narrow overvoltage spikes between the collector and the emitter may cause the gate-emitter resistance to open, while an excessive current through the IGBT's collector may cause the gate-emitter resistance to degrade [20].



**Loganathan and Selvam****SHORT CIRCUIT**

Although IGBT gate drive designs are often included with an overvoltage safety circuit, the issue of short circuits that have occurred in the past continues to exist. Electrical appliances that fail or trip the fuse are a result of poor power quality. The failure of a gate open-circuit may have an impact on thermal raw or high power dispersion [2]. Its turn-off switching characteristics, which are similar to those of a normal MOSFET but have the tail current caused by the recombination of the minority carrier (hole), and which is injected into the N- drift region, of the switching characteristic of BJT in IGBT [3, is an important drawback of the device. ]. This tail current is the primary cause of IGBT short-circuit failure, and it is often overlooked in circuit operations.

**SHORT-CIRCUIT FAILURE MECHANISMS**

Short-circuiting an IGBT may result in implied destruction of the failed IGBT, the other IGBTs, and other circuit components, since it produces unfettered high current across the circuit. As seen in Fig, short-circuit failures may be divided into four distinct categories.

**HIGH VOLTAGE BREAKDOWN**

IGBTs may be destroyed during turn-off by high voltage harpoons, which are persuaded by a fast decreasing rate of collector current (IC) and a sloppy inductance. This is particularly true when the harpoons are repeated repeatedly. Because of the high turn-off voltage shaft, the electric field may approach the critical field and cause one or more IGBT cells to fail first, resulting in a large leakage current as well as a high initial temperature, which can cause a short circuit. Later on, the heat flow from the overheated area diffuses rapidly into the nearby cells. Following the voltage shaft, the collector-emitter voltage (VCE) decreases, and the integrated circuit (IC) rises again. In addition, the gate outstation may fail, resulting in an increase in gate voltage (VGE) as a consequence. A high value of VCE and VGE might potentially result in a short circuit during the power-on process. During the turn-on process, there will be a sudden destruction and a peak current that will last for many hours.

**LATCH-UP STATIC / DYNAMIC STAGE**

This is a state in which the collector current is no longer controlled by the gate voltage and must be regulated by some other means. According to Fig.4, latch-up occurs when the parasitic NPN transistor is switched on, and it operates in conjunction with the primary PNP transistor as a thyristor, causing the gate to lose control of the integrated circuit. Latch-up in IGBTs may be classified into two types: static latch-up and dynamic latch-up. Stationary latch-up occurs at large collector currents, which causes the parasitic NPN transistor to switch on by adding the voltage drop across the parasitic resistance  $R_S$  to the collection current.

**LOCAL THERMAL BREAKDOWN**

Alternate breakdown is a kind of original thermal breakdown for transistors [36] that occurs as a result of high current strains, and it may occur in IGBTs during both the on-state and the turn-off states. In an alternative breakdown, the failure medium is as follows: when the current grows, the collector-base junction space-charge viscosity increases and the breakdown voltage lowers, resulting in an even greater increase in the current viscosity. This operation is repeated until the area of the high current viscosity zone is reduced to the smallest possible area of a stable current hair, at which point the process is completed.

**ENERGY SHOCKS**

During short circuit at the on- state, failure may be due to high power dispersion. Energy shock is described as a high power dispersion that occurs in a short period of time. Short-circuit currents above a certain threshold will result in energy shock and excessive temperature. Nonetheless, even if the junction temperature exceeds the specified temperature, the IGBT will not fail incontinently. Once the junction temperature reaches its natural temperature (about 250 °C for doped silicon), any further increase in junction temperature would result in an exponential increase in carrier attention and thermal raw. When temperatures are raised to dangerous levels, the silicon die may be irreversibly destroyed, and the contact essence may also be forced back into the junctions.





### Loganathan and Selvam

#### PARAMETER DRIFT

Drift in electrical characteristics such as VCE (ON) or ICE happens as a result of the buildup of damage inside a device or module. Drift occurs as a result of the degradation of a component, with electrical characteristics such as VCE (ON) or VCE (ICE) drifting beyond the acceptable operating range.

#### EFFECT OF TEMPERATURE ON NEW AND ELECTRICALLY-THERMALLY AGED IGBTs

A study was conducted to determine the impact of temperature on the behaviour of three electrical characteristics of IRG4BC30KD inverters. In this investigation, five fresh IGBTs were employed to establish a baseline for healthy behavioural patterns. Because of statistical fluctuations in manufacturing procedures like as channel doping and oxide charge, the electrical characteristics of transistors will be dispersed across a supply, even among transistors from the same manufacture lot [19]. To capture the type and extent of this dissemination, five novel pieces were employed in this experiment to gather the data. The behaviour of five old components with varying degrees of damage was then compared to that of the fresh parts to determine which was superior. The thermal stream generator was used to treat the items to temperatures ranging from 25 degrees Celsius to 200 degrees Celsius in increments of 25 degrees Celsius. This investigation was carried out in order to identify whether or not aged components react differently from fresh ones throughout a temperature range of various temperatures.

#### THRESHOLD VOLTAGE

This is the voltage at which an inverting gate bipolar transistor (IGBT) switches on and the collector current starts to flow. IGBTs have a negative temperature co-efficient for the threshold voltage, which means they perform better at cold temperatures. As has been seen, the threshold voltage decreases as the temperature rises. The rise in temperature causes a drop in the band-gap of the silicon, which results in a reduction in the threshold voltage. The IGBT is consequently more easily turned on at greater ambient temperatures as a result.

#### TRANS-CONDUCTANCE

The gain of a transistor is defined as the amount of output current (collector current) that may be obtained for a given voltage applied to the transistor's collector (gate voltage). The trans-conductance of IGBTs is negatively proportional to the temperature co-efficient. For the same gate voltage and temperature combination, the gain of the IGBT decreases with increasing temperature, resulting in a reduction in the output current from the transistor. According to the results of the trials, the trans-conductance of the aged parts is greater than the trans-conductance of the fresh parts. At room temperature, the difference between the average transconductance of fresh parts and the aged part "a1" is 8.2 percent, and the gap decreases to 5.6 percent when the temperature is raised to 200 degrees Celsius.

#### FAILURE ANALYSIS

Thermo-mechanical fatigue due to variations of power dissipation has been identified as a failure mechanism of IGBT.

**Die attach fatigue** failure model based on stress equation coupled with the Coffin Manson equation.

$$Nf = A \cdot f \cdot \alpha \cdot \Delta T - \beta \cdot G(T_{max}),$$

With

- ✓  $Nf$  = the number of cycles to fail
- ✓  $f$  = the cycling frequency
- ✓  $\Delta T$  = the temperature range during a cycle
- ✓  $G(T_{max})$  = Maximum temperature reached in each cycle
- ✓  $\alpha$  = Typical values for the cycling frequency exponent
- ✓  $\beta$  = temperature range exponent.

Failure rate is calculated by multiplying a base failure rate with several conditional factors.





### Loganathan and Selvam

$\Lambda_P = \lambda_b \pi_T \pi_A \pi_Q \pi_E$  failures/ $10^6$  hours

where  $\lambda_P$  = part failure rate

$\lambda_b$  = base failure rate

$\pi_T$  = temperature factor (Temperature factor does not account for temperature cycling input)

$\lambda_A$  = application factor

$\lambda_Q$  = quality factor

$\pi_E$  = environment factor

### FAILURE MODES MECHANISMS AND EFFECTS ANALYSIS (FMMEA) OF IGBTs

Using FMMEA, you may find implicit failure mechanisms and models for all implicit failure modes, as well as prioritise the failure mechanisms that have been identified. The outcome of the FMMEA process is a list of critical failure mechanisms that assist us in identifying the precursors to cover and the applicable drugs of failure models to use; this allows us to determine the element's remaining useful life by enabling the vaticinator to determine the element's remaining useful life. FMMEA is the first stage in the analysis of the mongrel prognostic approach that is being employed in this study (as explained in the mongrel PHM methodology section).

The failure mechanisms of the IGBT manifest themselves as a decrease in some critical electrical parameters (e.g., leakage current, threshold voltage) or as a loss of functionality (incapability to turn-off). Failures may be caused by environmental circumstances or by operational conditions, among other things. For example, excessive moisture levels might cause electrical connections to corrode, resulting in breakdowns in the electrical system. Large temperature changes might also create failures by causing unstable expansion inside the many accessories that make up the gadget that is functioning in interface decline.

### CONCLUSION

It is a very significant problem, both in the design process and in the operating phase of power electronic transformers, when a catastrophic failure of an IGBT occurs. This research examines the failure processes of two open-circuit modes and four short-circuit modes, as well as their interactions. Despite the fact that the initial driving forces for various failure types are different, the ultimate destruction is virtually always caused by overheating, demonstrating the importance of thermal design and fine thermal operation of IGBTs in trustability-critical processes. The availability of several circuit-position fault-tolerant findings to insulate faulty IGBTs and improve motor trustability, both of which have been discussed in this study, is abundant at the current time. According to the findings of this study, a rigorous technique for determining the failure mechanisms that may occur on a power element such as an IGBT under harsh operating circumstances was created. It was emphasised that a specialised simulation analysis may be employed to concentrate attention away from the two primary processes (breakdown and thermal raw) that lead to a devastating failure. Because of the variability in vaticination, the mean time to failure rate is used to prognosticate that IGBT continuity will not be adequate to prevent unplanned failures in the field owing to vaticination variability. An essential strategy to preventing failures is to monitor IGBT health collectively while they are in operation, utilising a data-driven system to examine the operational data and detect any abnormalities before they cause a failure. Take action based on life cycle condition information gathered via monitoring. Make use of the anomalous data in order to determine your location. Establishing a capacity for determining useful life is essential.

### REFERENCES

1. Xiao Ma, Yongle Huang and Yifei Luo, "IGBT Failure mechanism and boundary analysis under large current and high temperature turn-off, Journal of Physics: Conference Series, 1754 (2021) 012036, IOP Publishing, doi:10.1088/1742-6596/1754/1/012036





**Loganathan and Selvam**

2. Emma Arfa Grunditz , Torbjörn Thiringer , *Member, IEEE*, and Nima Saadat , *Member, IEEE* " Acceleration, Drive Cycle Efficiency, and Cost Tradeoffs for Scaled Electric Vehicle Drive System" IEEE Transactions on industry applications, VOL. 56, NO. 3, MAY/JUNE 2020
3. Zhengping Wang <sup>1</sup>, Guoyi Li <sup>1</sup>, Ming-Lang Tseng <sup>2,3,4,\*</sup> , Wai-Peng Wong <sup>5</sup> and Boying Liu <sup>6</sup> "Distributed Systematic Grid-Connected Inverter Using IGBT Junction Temperature Predictive Control Method: An Optimization Approach" 17 April 2020; Accepted: 7 May 2020; Published: 17 May 2020 Symmetry 2020, 12, 825; doi:10.3390/sym12050825
4. Jiangyong Zhang, Mingxing Du , Lei Jing, Kexin Wei, and William Gerard Hurley, *Fellow, IEEE* "IGBT Junction Temperature Measurements: Inclusive of Dynamic Thermal Parameters" IEEE Transactions on Device and Materials Reliability, VOL. 19, NO. 2, JUNE 2019.
5. S.S. Moosavia,, A. Kazemib, H. Akbarib, "A comparison of various open-circuit fault detection methods in the IGBT-based DC/AC inverter used in electric vehicle" Engineering Failure Analysis 96 (2019) 223–235. <https://doi.org/10.1016/j.engfailanal.2018.09.020>. 13 September 2018 1350-6307/ © 2018 Elsevier Ltd. All rights reserved.
6. Nathan Valentine, Dr. Diganta Das, and Prof. Michael Pecht "Failure Mechanisms of Insulated Gate Bipolar Transistors (IGBTs)" 2015 NREL Photovoltaic Reliability Workshop, University of Maryland
7. Bing Ji, Member, IEEE, Xueguan Song, Wenping Cao, Senior Member, IEEE, Volker Pickert, Member, IEEE, "In Situ Diagnostics and Prognostics of Solder Fatigue in IGBT Modules for Electric Vehicle Drives" IEEE TRANSACTIONS ON POWER ELECTRONICS, VOL. 30, NO. 3, MARCH 2015. Digital Object Identifier 10.1109/TPEL.2014.2318991
8. C. Delepout, S. Siconolfi, O. Mourra, and F. Tonicell, "MOSFET gate open failure analysis in power electronics," Proceedings of 28th Annual IEEE Applied Power Electronics Conference and Exposition (APEC2013), pp.189-196, Mar. 2013.
9. G. Breglio, A. Irace, E. Napoli, M. Riccio, and P. Spirito, "Experimental detection and numerical validation of different failure mechanisms in IGBTs during unclamped inductive switching," IEEE Transactions on Electron Devices, vol. 60, no. 2, pp. 563-570, Feb. 2013
10. E. Sutrisno, "Fault Detection and Prognostics of Insulated Gate Bipolar Transistor (IGBT) Using K-Nearest Neighbor Classification Algorithm," M.S. dissertation, Dept. Mech. Eng., University of Maryland, College Park, MD, 2013.
11. D. W. Brown, M. Abbas, A. Ginart, I. N. Ali, P. W. Kalgren, and G. J. Vachtsevanos, "Turn-off time as an early indicator of insulated gate bipolar transistor latch-up," IEEE Transactions on Power Electronics, vol. 27, no. 2, pp. 479-489, Feb. 2012
12. V. Smet, F. Forest, J.-J. Huselstein, F. Richardeau, Z. Khatir, S. Lefebvre, and M. Berkani, "Ageing and failure modes of IGBT modules in high temperature power cycling," IEEE Trans. Ind. Electron., vol. 58, no. 10, pp. 4931\_4941, Oct. 2011.
13. Yihua Hu, *Member, IEEE*, John William Mackersie, and Gareth PierceC. Busca, R. Teodorescu, F. Blaabjerg, S. Munk-Nielsen, L. Helle, T. Abeyasekera, and P. Rodriguez, "An overview of the reliability prediction related aspects of high power IGBTs in wind power applications," Microelectron. Rel., vol. 51, nos. 9\_11, pp. 1903\_1907, Sep. 2011.
14. N. Patil, "Prognostics of Insulated Gate Bipolar Transistors," Ph. D. dissertation, Dept. Mech. Eng., University of Maryland, College Park, MD, 2011.
15. B. Wang, A. Hu, Y. Tang, and M. Chen, "Analysis of voltage breakdown characteristic of IGBT," Transactions of China Electrotechnical Society, vol.26, no. 8, pp.145-150, Aug. 2011.
16. S. Yang, D. Xiang, A. Bryant, P. Mawby, L. Ran, and P. Tavner, "Condition monitoring for device reliability in power electronic converters: A review," IEEE Trans. Power Electron., vol. 25, no. 11, pp. 2734\_2752, Nov. 2010.
17. H. Lu, C. Bailey, and C. Yin, "Design for reliability of power electronics modules," Microelectron. Rel., vol. 49, nos. 9\_11, pp. 1250\_1255, Sep. 2009.
18. N. Patil, J. Celaya, D. Das, K. Goebel, and M. Pecht, "Precursor parameter identification for insulated gate bipolar transistor (IGBT) prognostics," IEEE Trans. Rel., vol. 58, no. 2, pp. 271\_276, Jun. 2009.



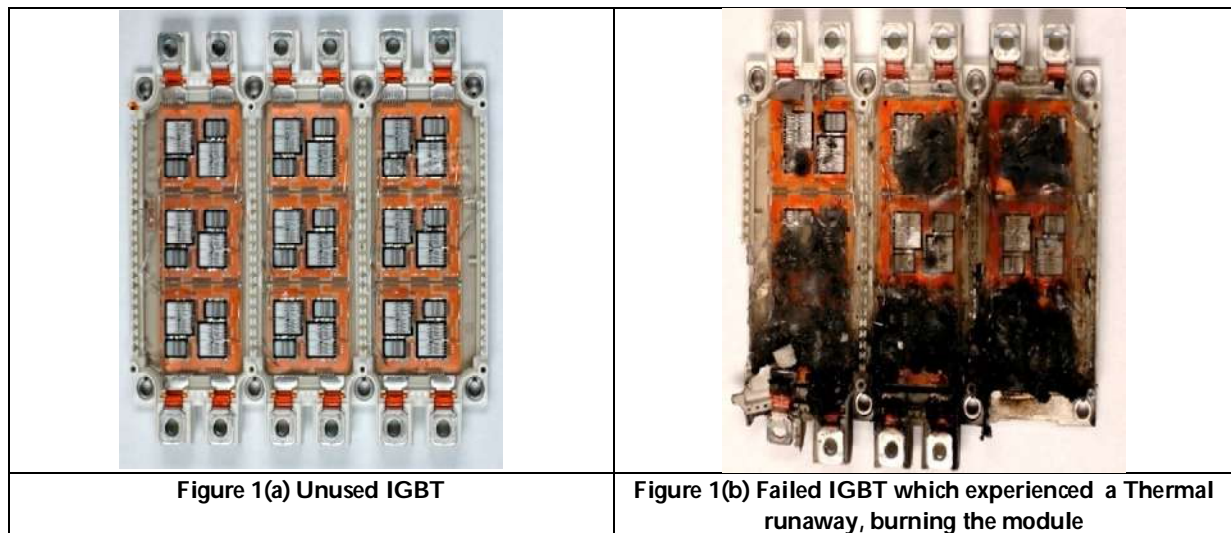


**Loganathan and Selvam**

19. X. Perpiñà, J. F. Serviere, X. Jorda, S. Hidalgo, J. Urresti-Ibanez, J. Rebollo, and M. Mermet-Guyennet, "Over-current turn-off failure in high voltage IGBT modules under clamped inductive load," Proceedings of 13th European Conference on Power Electronics and Applications (EPE '09), pp.1-10, 2009.
20. N. Patil, J. Celaya, D. Das, K. Goebel, and M. Pecht, "Precursor parameter identification for insulated gate bipolar transistor (IGBT) prognostics," IEEE Transactions on Reliability, vol. 58, no. 2, pp. 271- 276, Jun. 2009.

**Table 1. Failure Module and Failure Mechanism**

Failure Mechanism	Failure Sites	Failure Causes	Failure Models
Fatigue	1. Die attach 2. Wire bond 3. Solder leads 4. Bond pads 5.Traces, 6. Vias/PTHs 7.Interfaces	Cyclic Deformations 1. $\Delta T$ - Cyclic Temperature 2. $\Delta H$ - Cyclic Humidity 3. $\Delta V$ - Cyclic Voltage	Nonlinear Power Law by Coffin-Manson
Corrosion	Metallization	1. M - Moisture 2. $\Delta V$ - Cyclic Voltage 3. T - Temperature 4. Chemical	Eyring
Electromigration	Metallization	1. T - Temperature 2. J - Current density	Eyring
Conductive Filament Formation	Between Metallization	1. M - Moisture 2. $\Delta V$ - gradient Voltage	Power Law
Stress Driven Diffusion Voiding	Metal Traces	1. $\sigma$ - Stress 2. T - Temperature	Eyring
Time Dependent Dielectric Breakdown	Dielectric layers	1. V - Voltage 2. T - Temperature	Arrhenius





Loganathan and Selvam

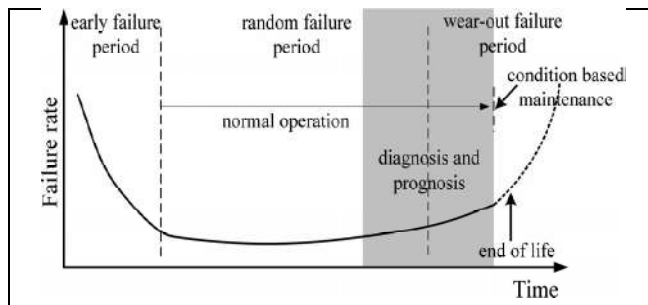


Figure 2 Failure rate of IGBT over their lifetime

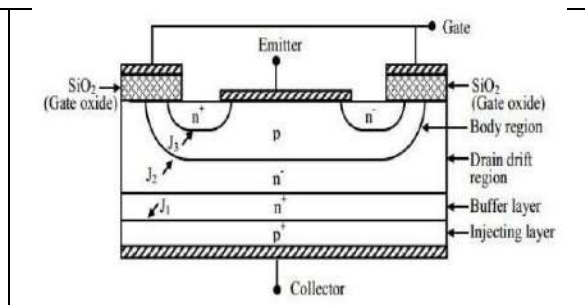


Figure 3(a) Schematic Diagram of IGBT

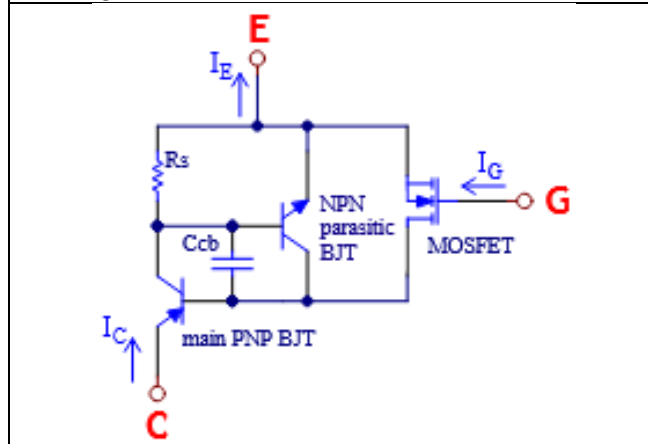


Figure 3(b) Equivalent Circuit of IGBT

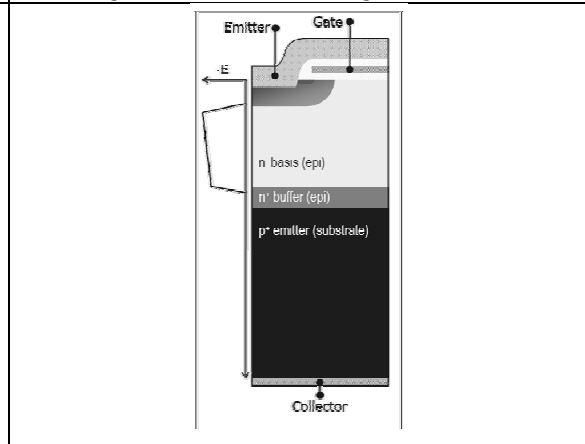


Figure 4 The punch-through IGBT (additional n+ layer)

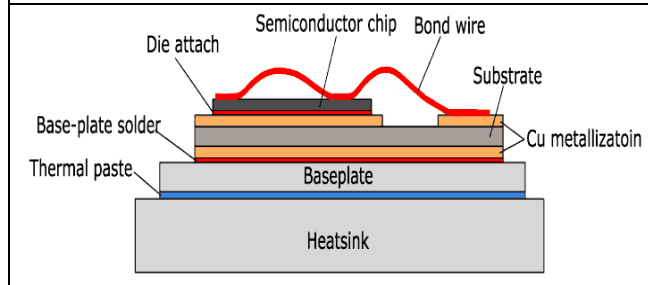


Figure 5(a) Cross section of Die attach in IGBT with Heat sink

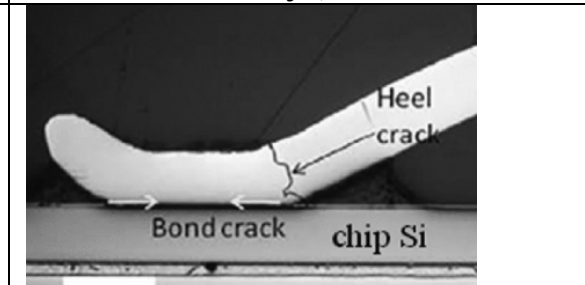


Figure 5(b) Wire lift mechanism of IGBT

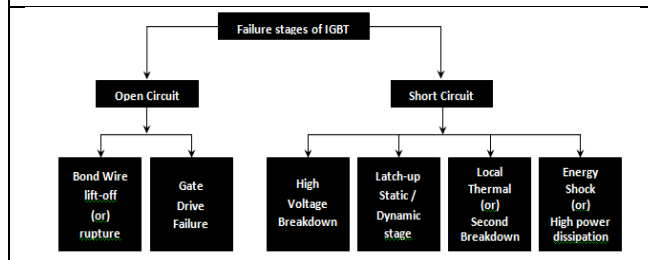


Figure 6 Classifications of Failure Stages

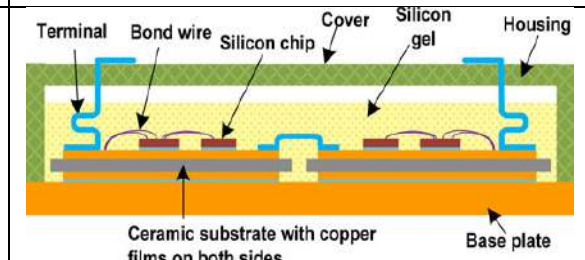


Figure 7 Schematic diagram of a standard IGBT module





Loganathan and Selvam

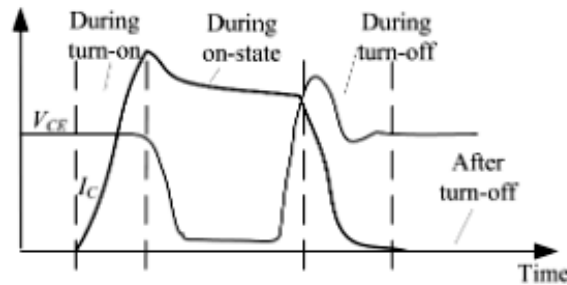


Figure 8. Time-sequence Classification of IGBT short circuit failure

LOCATION	PROBLEM	REASON	EFFECTS
Gate	1. Short Circuit 2. Loss of Gate Control 3. Increasing Leakage Current	1. over Voltage 2. High Electric Field 3. High Temperature	1. Frequent Breakdown 2. $V_{CE}$ Problem 3. $G_m$ Problem
Silicon Die	1. Loss of Gate Control 2. Device burn out	1. over Voltage 2. High Electric Field 3. Ionizing Radiation	1. $V_{CE}$ (cont) 2. Latch-up Problem
Substrate Body	1. High Leakage Current 2. Oxide Substrate Interface	1. Over voltage 2. High current densities	1. Frequent Breakdown 2. $V_{CE}$ Problem 3. $G_m$ Problem due to Hot Electron
Bond Wire	1. Open Circuit	1. High Temperature 2. High current densities	1. $V_{CE}$ (cont) 2. Lift off 3. Bond wire Cracking
Die Attach	1. Open Circuit	1. High Temperature 2. High current densities	1. Voiding 2. Delamination of Die Attach

Figure 9 Failure Modes and Mechanisms







## Effect of Ferulic Acid from Defatted Rice Bran on Lung and Breast Cancer Cell Lines (*In vitro*)

P.Avanthi<sup>1</sup>, Nora Vigasini<sup>1\*</sup> and Shanmugapriya Surenderan<sup>2</sup>

<sup>1</sup>Department of Home Science, Women's Christian College (Autonomous), (Affiliated to the University of Madras), Chennai, Tamil Nadu, India

<sup>2</sup>Whizbang Bioresearch Pvt Ltd., 20, Pillayar Koil Street, Thiruverkadu, Chennai - 600 077, Tamil Nadu, India.

Received: 30 Oct 2021

Revised: 15 Dec 2021

Accepted: 03 Jan 2022

### \*Address for Correspondence

**Nora Vigasini**

Department of Home Science,  
Women's Christian College (Autonomous),  
(Affiliated to the University of Madras),  
Chennai, Tamil Nadu, India.

Email: noravigasini267@gmail.com



This is an Open Access Journal / article distributed under the terms of the **Creative Commons Attribution License** (CC BY-NC-ND 3.0) which permits unrestricted use, distribution, and reproduction in any medium, provided the original work is properly cited. All rights reserved.

### ABSTRACT

Rice, one of the globally consumed cereals, produces a nutrient dense by-product, the "bran", used for oil extraction and the remnants are used as animal feed which also contains bioactive compounds. Ferulic acid, is one common phenolic compound present in the defatted rice bran. It has been used as an antioxidant in food preservation. It is also shown to act against free radicals and inhibit proliferation among cancerous cells. In this study ferulic acid was extracted from defatted rice bran and its *in vitro* efficacy on lung (A549) and breast (MCF -7) cancer cell lines were studied. The total phenol present in the sample was estimated by Folin- Ciocalteu methods. Ferulic acid was extracted using HPLC. Antioxidant activity was determined using 1,1-diphenyl-2-picrylhydrazyl (DPPH) assay and hydrogen peroxide scavenging assay and anticancer activity was assessed using MTT assay. Phenol was estimated to be 27.37 µg/ mL and ferulic acid extracted by HPLC was 0.21%. The IC<sub>50</sub> values of DPPH radical scavenging assay and hydrogen peroxide assay was found to be 400.86 and 69.60 µg/mL respectively. The IC<sub>50</sub> values were 162 and 197 µg/mL on lung and breast cancer lines respectively. From this *in vitro* study it can be observed that ferulic acid has a potential to arrest the proliferation of cancer cells. Hence, ferulic acid extracted from defatted rice bran can be considered as a versatile phenolic compound mitigating problem caused by the dreadful disease cancer.

**Key words:** Anti-cancer, Antioxidant, Breast cancer, Ferulic acid, Lung cancer, Defatted rice bran.



**Avanthi et al.,**

## INTRODUCTION

The increase in the incidence of cancer has burdened affected individuals physically, mentally and financially. It has been estimated that worldwide around 19.3 million new cases and 10.0 million deaths had occurred in 2020 due to cancer. Breast cancer among women and lung cancer among men are the leading types of cancer. An increase of about 47% of breast and lung cancers has been projected by the year 2040 [1]. Phytochemicals present in food have shown to possess antioxidant properties, that scavenge free radicals to bring homeostasis. These free radical scavenging properties have the potential to inhibit the growth of few malignant growths [2][3]. Bran, a by-product of milling fractions has gained much importance as it is a treasure of health promoting bioactive compounds, antioxidants and phytonutrients that help in the prevention of diseases. These milled products are wasted but keeping in mind its nutritional benefits, one can extract the important compounds present in them using modern technology, and produce nutraceutical compounds that are rich in antioxidant. At the same time are economical and safe for human consumption. Clinical trials have shown that antioxidants in cereal grains have prevented cardiovascular diseases and many cancers [4].

As researchers continue to search for sources of natural antioxidants, it has been found that plants from Gramineae family contain many phytochemicals that can act as antioxidants. Rice, globally is the staple crop for many countries and also a major source of calories [5]. Experimental studies have shown that major bioactive compounds like the phytochemicals in cereals are found in the bran/germ portion when compared to the grain portion and it is observed that more than 67% of the total nutrition of the rice is contributed by the bran portion [6]. Basically, rice bran (RB) is used for animal feed or for the extraction of oil. After the extraction of edible oils, it leaves behind a cake/meal (referred to as defatted or rice bran oil soapstock) which is also a rich source of phytochemicals like oryzanols, tocopherols and ferulic acid [7].

Ferulic acid, the simplest phenolic compound most abundantly found in plants and in many principal foods such as vegetables, fruits, cereals and coffee. Ferulic acid gets absorbed quickly and is found to be staying longer in the bloodstream when compared to other phenolics[8]. Ferulic acid has been shown to play many important biological functions like anti-inflammatory, antidiabetic, anticancer effects. It is an excellent antioxidant; this is due to the phenolic hydroxy group present in its structure [9]. It has also been shown to have anticancer potential. The cytotoxic effect is produced by inhibiting the intracellular signals that initiate abnormal cell growth. This in turn activates cell death and brings redox balance[2][3].

There are plenty of studies on ferulic acid its extraction, optimization from various sources, on rice bran protein hydrolysates, peptides, fiber and cancer but very few studies on extraction of ferulic acid from defatted rice bran (DRB) and its efficacy on cancer. The present study aimed at the extraction of ferulic acid by alkaline hydrolysis of defatted rice bran and the determination of its anti-cancer efficacy against lung and breast cancer cell lines.

## MATERIALS AND METHODS

### Materials

The standards gallic acid, DPPH were purchased from Sigma Aldrich (St. Louis, USA). Folin-Ciocalteu reagent was purchased from Merck (Darmstadt, Germany) and all other chemicals used were of analytical grade. Rice bran was procured from a local mill in Chennai, Tamil Nadu, India.

### Preparation of defatted Rice Bran

The rice bran was sieved to remove impurities using 40-micron mesh. Rice bran was defatted using hexane as described by Wang et al. [10] to produce defatted rice bran. Bran and hexane were taken in the ratio 1:3 (w/v) in a closed container and placed on a magnetic stirrer at 50 °C for 30 min. Hexane was removed and defatted bran was



**Avanthi et al.,**

kept for 18 hours to 24 hours in a hood. The defatted rice bran obtained from the above process was sieved (40 micron mesh size) and stored in a refrigerator until further use.

**Extraction of ferulic acid (FA)**

Ferulic acid was extracted in accordance to the procedure given [11] with modifications. The sample was dried in an oven at 40 °C for 12 h prior to extraction. Accurately weighed 50 g of finely ground DRB sample was taken in a 1000 mL Erlenmeyer flask and refluxed with 2 M NaOH for 6 hours at 60 °C and then cooled down to 20 °C. The extract was filtered. Then pH of the extract was reduced with dilute hydrochloric acid so that the hemicellulose would precipitate. The solution was filtered and subsequently, 500 mL ethyl acetate was added to the filtrates and was vigorously shaken in a magnetic stirrer at room temperature to carry out a liquid-liquid extraction. The solution was concentrated by a rotary vacuum evaporator (Buchi Rotavapor R-124, Switzerland) to remove excess solvent. The concentrated extract was dissolved in 2 mL ethanol and stored at 4 °C for further assays.

**Estimation of Total Phenol Content (TPC)**

The presence of phenols was confirmed using Ferric chloride test [12] and the phenol was quantified. Estimation of total phenol was carried as follows: about 2.5, 5, 10, 15, 20 µg/mL of standard Gallic acid aliquots were pipetted out into a series of test tubes. In another test tube 250 µg/mL of the sample was taken. To all the tubes 20% Na<sub>2</sub>CO<sub>3</sub> was added followed by the addition of FolinCiocalteu reagent and kept undisturbed at room temperature for 30 minutes. Depending on the phenolic concentration the intensity of blue colour varies. The reagent blank was prepared without sample. The samples were read at 700 nm [13].

**Estimation of ferulic acid by HPLC**

The HPLC studies were carried out on Agilent 1260 series operated by Agilent Openlab software and separations were achieved on a reversed-phase Agilent HC-C18(2) column with a particle size of 5µ. Acetonitrile and 10% acetic acid (20:80 v/v) was used for the mobile phase analysis. The various concentrations of 200, 600, 1800, 2600, 4000, 5000, 6000, and 7000 ng/mL of a standard solution of ferulic acid was prepared using methanol as a solvent and was injected, calibration curve was constructed using the detector response. The extract was prepared with 0.04% methanol solution. The amount of ferulic acid was determined by comparing the peak area corresponding to ferulic acid with that of the calibration curve [14].

**ESTIMATION OF ANTIOXIDANT ACTIVITY OF FA FROM DRB****By DPPH radical scavenging assay**

This method is based on the principle, where a stable free radical is reduced by the electron transfer (hydrogen atom) from the test sample. The DPPH activity was performed with the following modifications: about 10, 50, 100, 150, 200 µg/mL aliquots of extract (FA from DRB) were pipetted out into a series of test tubes. A stock solution was prepared using methanol (DPPH 1mM). Two millilitres of DPPH solution was added to the test tubes and kept undisturbed in the dark at room temperature for 10 minutes. The reagent blank was prepared without a sample. The reference standard was ascorbic acid. Then samples were read at 520 nm [13].

**By hydrogen peroxide radical scavenging activity**

The ability of the test sample to donate its hydrogen atom coupled with an electron transfer reaction can be measured using this assay. This was performed with some modifications: about 100, 200, 400, 600, 800, and 1000 µg/mL aliquots of the extracted sample was pipetted out into a series of test tubes. The volume in all tubes was made up to 1.0 mL using distilled water. To all the tubes 40mM hydrogen peroxide was added and kept undisturbed at room temperature for 10 min. The reagent blank was prepared without a sample. The butylated hydroxytoluene (BHT) was used as a reference. Then samples were read at 230 nm [15].





**Avanthi et al.,**

### ANTICANCER ACTIVITY BY MTT ASSAY ON VERO CELLS, LUNG AND BREAST CANCER CELL LINES

All the cell lines were purchased from NCCS Pune (MCF -7 (breast cancer) and A549 (lung cancer) and Vero cell lines). Cell proliferation (MTT) assay was performed and the percentage of cell viability was determined spectrophotometrically<sup>[16]</sup>. The cell lines were pre-grown in a DMEM medium, 10% foetal bovine serum (FBS), 100 U/mL penicillin and 100 µg/mL streptomycin was added. For the experiment, tissue culture flasks containing DMEM medium (25 cm ×25 cm ×25 cm) along with the cells were grown at 37 °C under a humidified atmosphere of 95% air and 5% CO<sub>2</sub>. The extract was prepared at a concentration of 10 mg/mL (stock solution). The complete DMEM supplemented with 10% FBS and antibiotics was considered as the working stock solution. The MTT solution was prepared in phosphate buffer solution (PBS) and left for incubation for 48 hours. Later, 50 µL of MTT solution was pipetted in each well to make up to 1 mg/mL as the final concentration. The plate was left in an incubator for 3 hours.

The formazan crystals formed were air dried in dark place for 30 min at room temperature and dissolved in 100 µL DMSO. The plates were mildly mixed and left at room temperature for 10 minutes. The optical density was read using Synergy HT microplate reader at 570 nm. Using the following formula the percentage growth was calculated. The percentage growths were calculated using the following formula:

$$\text{Percentage growth} = 100 \times [(T - T_0) / (C - T_0)]$$

Where,

T = optical density of test,

C = optical density of untreated control,

T<sub>0</sub> = optical density at time zero (at the time of compound addition).

A dose response curve was obtained from the percentage growth. The growth curves were used and the GI50 values were interpolated.

### STATISTICAL ANALYSIS

All analysis was done in triplicates and expressed as mean ± standard deviation. Students t – test was used to evaluate statistical differences between means using statistical tool Graph pad Prism 5. Results were considered significant at 5% significance.

## RESULTS AND DISCUSSION

### Yield extracts, TPC and Ferulic Acid from DRB quantification by HPLC

Yield extracted using alkali treatment was 1.0216 g (2.043%) from 50 g of DRB. Results of ferric chloride test indicated the presence of phenol. The concentration of phenol present in the sample was determined by the standard graph of Gallic acid solution and it was found to be 27.37 µg/mL. The extract had 0.21% of ferulic acid, this was quantified with HPLC. In a study by Hartati et al., [17] three different extracts of defatted rice bran (DRB) (i) methanolic extract of DRB (METE) (ii) residual extract (RESE) from hydrolysed extract of DRB (iii) DRBE using ethyl acetate and extract of hydrolysed DRB. The three DRB had yielded 3.79 ± 0.18; 0.59 ± 0.16 and 0.65 ± 0.17% METE, RESE and DRBE respectively. The methanolic extract (METE) had the highest yield. The yield obtained in this study is closer to that of methanolic extract of DRB.

Extraction of ferulic acid using commercial and bacterial enzymes produced 0.68 µg/mg from defatted rice bran, while the alkali treatment produced 3.99 µg/mg [18]. Alkali treatment produced more FA than the enzymatic treatment in his study. Alkali treatment helps in breaking the ester linkages bonded with polysaccharides and lignin. A study was conducted among different rice varieties and their bran relation to the bioactive compounds across Malaysia. In the study ferulic acid, gamma oryzanol and GABA content was estimated among 53 locally grown varieties. It was noticed that the amount of FA across locations did not have significant differences but significant differences were observed between bran colours. The purple bran colour variety was found to be higher in FA content followed by red colour and light brown colour. Studies have shown that darker pigmented rice varieties



**Avanthi et al.,**

(whole grain rice) had higher phenolic and antioxidant levels where FA played an important role as an antioxidant in dark pigmented varieties[19].

### Antioxidant activity

#### DPPH assay

In this study, DPPH radical scavenging assay was used to assess the free radical scavenging potential of ferulic acid from DRB. The violet colour DPPH is reduced to the colourless solution, indicating the formation of diphenyl picryl hydrazine, the reduced form. The results are expressed in IC<sub>50</sub> value, that is the concentration of extract that shows 50% inhibition of free radicals. The IC<sub>50</sub> Value was found to be 400.866 µg/mL. The DPPH activity of FA was found to be significant ( $p < 0.05$ ). As the concentration of the sample increased, the percentage of inhibition also increased (Fig. 1) and at 1000 µg/mL the FA extract exhibited 70.09% inhibition. A study conducted in the production and characterisation of ferulic acid from pineapple waste observed that the extract had 87.3% inhibition at 1000 µg/mL while standard ferulic acid had 81.92% inhibition [20]. The results of FA from DRB can be compared that of ferulic acid of pineapple peel.

#### Hydrogen Peroxide Radical Scavenging Assay:

The IC<sub>50</sub> Value was found to be 69.60 µg/mL. The various concentrations used were 100, 200, 400, 600, 800 and 1000 µg/mL. At the least concentration (100 µg/mL) FA had 75.76% inhibition and at 1000 µg/mL it had 98.48% inhibition (Fig.2). Hydrogen peroxide is generated by several oxidase enzymes *in vivo*, initiated during phagocytosis and is thought to be the major precursor for the production of reactive oxygen species. In a study, it was identified that FA as a molecule inhibited apoptosis induced by H<sub>2</sub>O<sub>2</sub> in the rat pheochromocytoma, PC12 cell. Ferulic acid restored the expression of brain-derived neurotrophic factor (BDNF), and increased its expression by increasing the expression of microRNA – 10b. Ferulic acid was found to have a broader spectrum of biological effects [21]. The antioxidant mechanism of ferulic acid involves complex reactions. Ferulic acid primarily inhibits the formation of ROS or RON and also by neutralizing these free radicals. Ferulic acid not only scavenges free radicals but it has shown to inhibit the enzymes that catalyse the generation of free radicals and also increases the enzymes involved in scavenging activity. The proposed antioxidant activities are as free radical scavenging, binding to transition metals such as copper and iron and prevention of lipid peroxidation [22].

When FA comes in contact with the free radical, the hydrogen atom on FA moves to a state of stable phenoxy radical and forms an equilibrium. This radical is so stable that it does not undergo further degeneration. It is assumed that the change allows in the condensation with another radical, adds another phenoxy radical and thus forms dimers. On the other part, the carboxyl group present in FA molecule protects against lipid peroxidation by binding with fats. Thus FA combats free radical scavenging chain reactions by forming the stable resonant structure of phenoxy radical[8][23].

#### **In vitro anticancer activity of the FA extract from DRB on Lung cancer (A549) and Breast cancer cell lines (MCF -7) by MTT assay**

The cytotoxic potential of the sample was evaluated using the MTT assay. The assay is based on the principle of the viability of cancer cells. The metabolically active cells turn the yellow tetrazolium salt into a dark purple coloured product, formazan. This purple product is directly proportional to the number of viable cells that can be read colorimetrically[24]. The *in vitro* anticancer activity of ferulic acid was determined on Vero cells (Non – cancerous cell line - Monkey Normal Kidney cells) and two cancerous cell lines (A549 – lung cancer and MCF – 7 – breast cancer cell lines). The FA activity on Vero cell lines was non-cytotoxic to a non-cancer cell line up to 200 µg/mL (IC<sub>50</sub> value = 180 µg/mL). The Vero cells are used generally to understand and confirm whether the compound used is safe. Effect of ferulic acid on lung and breast cancer cell lines were determined and the IC<sub>50</sub> value were 162 and 197 µg/mL for the respective cell lines (Fig.3). It was observed that as the concentration of the sample increased, the viability of the cells decreased.



**Avanthi et al.,**

In a study by Nasr Bouzaiene et al., [25] was conducted on superoxide anion production, proliferation, cell adhesion and migration efficacy of caffeic, coumaric and ferulic acid on human lung cancer (A549) and colon adenocarcinoma (HT – 29 D4) cancer cell lines. The concentration of phenols used ranged between 50 – 1000  $\mu$ M and it was observed that proliferation of the cells was significantly inhibited in both the tested cell lines in a dose dependant manner. The superoxide anion production also reduced in A549 and HT – 29 D4 cell lines. Similar results were observed in this study where proliferation of the cells decreased as the concentration increased.

A study explored the antiproliferative and proapoptotic activity of FA on MCF- 7 and HepG2 human cancer cell lines via MTT assay (cytotoxicity), Annexin V staining, ELISA (enzyme linked immunosorbent assay), and caspase – 8 and 9 activation (proapoptotic activity). The  $IC_{50}$  value of FA on MCF- 7 and HepG2 was 75.4 and 81.38  $\mu$ g/mL, respectively. Apoptosis was observed on staining and increase in capsase – 8 and 9 levels were noticed after incubation of both the cell lines with FA [26]. In the present study also FA extract from DRB showed cytotoxic effect on MCF – 7 cell line in a dose dependent manner.

The study by Thakkar et al., on the human pancreatic cancer cell line MIA PaCa-2, FA combined with aspirin decreased cell viability, migration and also prognosis of the disease [27]. (Thakkar) Gao et al., studied the effect of FA on Hela and Caski cervical cancer cell lines. The study investigated the cell proliferation, invasion, apoptosis and autophagy and also their protein expressions. The inhibition was 88.3 and 85.4% respectively on Hela and Caski cell lines. There was inhibition of cell invasion and also decreased expression of autophagy-related proteins in a dose-dependent manner [28]. The ferulic acid in grains is contributed by hydroxycinnamic acid, which is present in the ester (bound) form along with polysaccharides. These are released from their bound forms by the action of microbial esterase. The antimutagenic effect is produced by the free feruloyl groups that pass the colon [29]. Ferulic acid along with hydroxycinnamic acid derivatives have also shown to scavenge nitrogen dioxide radicals produced as a result of nitrate and nitrite metabolism.

**CONCLUSION**

Rice bran, an end product of milling used for the extraction of oils, ends in landfills or as animal feed. It is important to make use of this nutrient-rich agrobio-product to extract its components and further use them as a nutraceutical, pharmaceutical or as a food additive. In this study, ferulic acid extracted from defatted rice bran has been shown to scavenge free radicals and also arrest the proliferation in lung and breast cancer cell lines in a dose-dependant manner. As it has shown promising results it is now necessary to further study the *in vivo* toxicological effects and also elucidate molecular mechanisms involved in producing anticancer effects.

**CONFLICT OF INTEREST**

The author(s) declare no conflict of interest

**ABBREVIATIONS**

DRB: defatted rice bran; FA: ferulic acid; DPPH: 2,2-diphenyl-1-picrylhydrazyl; BHT: butylated hydroxy toluene; MTT: 3-(4,5-dimethylthiazol-2-yl)-2,5-diphenyl tetrazolium bromide; TPC: total phenol content.

**REFERENCES**

1. Sung, H., Ferlay, J., Siegel, R. L., Laversanne, M., Soerjomataram, I., Jemal, A., & Bray, F. Global cancer statistics 2020: GLOBOCAN estimates of incidence and mortality worldwide for 36 cancers in 185 countries. *CA Cancer J Clin.* 2021; 71(3):209-249
2. Karamac, M., Koleva, L., Kancheva, V. D., & Amarowicz, R. The structure-antioxidant activity relationship of ferulates. *Molecules* 2017; 22(4):527





## Avanthi et al.,

3. Loo, G. Redox-sensitive mechanisms of phytochemical-mediated inhibition of cancer cell proliferation. *J NutrBiochem* 2003; 14: 64–73
4. Ghose, B., Kpoghomou, M., Shamsitdinov, H., Mondal, A., & Sarker, S. Nutraceutical potential of rice and wheat antioxidants and their impacts on health. *Oxid Antioxid Med Sci* 2013; 2(4): 245-249
5. Kurutas, E. B. The importance of antioxidants which play the role in cellular response against oxidative/nitrosative stress: Current state. *Nutr J* 2016; 15: 1-22.
6. Liyana-Pathirana, C. M., & Shahidi, F. The antioxidant potential of milling fractions from breadwheat and durum. *J. Cereal Sci* 2007; 45(3): 238–247
7. Renuka Devi, R., & Arumughan, C. Phytochemical characterization of defatted rice bran and optimization of a process for their extraction and enrichment. *Bioresour. Technol* 2007; 98(16):3037–3043
8. Tee-Ngam, P., Nunant, N., Rattanarat, P., Siangproh, W., & Chailapakul, O. Simple and rapid determination of ferulic acid levels in food and cosmetic samples using paper-based platforms. *Sensors (Switzerland)* 2013; 13(10): 13039–13053
9. Adom, K. K., & Liu, R. H. Antioxidant activity of grains. *J. Agric. Food Chem* 2002; 50 (21): 6182–6187
10. Wang, C., Xu, F., Dan, L., & Zhang, M. Physico-chemical and Structural Properties of Four Rice Bran Protein Fractions Based on the Multiple Solvent Extraction Method. *Czech J. Food Sci.*, 2015; 33(3): 283–291.
11. Aarabi, A., Honarvar, M., Mizani, M., Faghihian, H., & Gerami, A. Extraction and purification of ferulic acid as an antioxidant from sugar beet pulp by alkaline hydrolysis. *Ital. J. Food Saf*, 2016; 28(3): 362–375.
12. Ifemeje, J., Egbuna, C., Eziokwudiaso, J., & Ezebuo, F. Determination of the Anti-nutrient Composition of *Ocimum gratissimum*, *Corchorus olitorius*, *Murrayakoenigii Spreng* and *Cucurbita maxima*. *International Journal of Innovation and Scientific Research*, 2013; 3,2351–8014.
13. Jamuna, S., Paulsamy, S., & Karthika, K. Screening of in vitro antioxidant activity of methanolic leaf and root extracts of *Hypochoeris radicata* L. (Asteraceae). *J App Pharm Sci* 2012; 07: 149–154.
14. Kareparamban, J. A., Nikam, P. H., Jadhav, A. P., & Kadam, V. J. A. Validated High-performance Liquid Chromatography Method for Estimation of Ferulic Acid in Asafoetida and Polyherbal Preparation. *Indian J. Pharm. Sci.* 2013; 75(4): 493.
15. Sundaram, S., Chella Perumal, D. P., Palanirajan, A., Balu, V., Prabhakaran, P., & Gopalakrishnan, V. K. Quantitative analysis and in vitro free radical scavenging activity of *Cayratia trifolia* (L.). *World J. Pharm. Res.* 2014; 3,973–988.
16. Dantu, A., P, S., D, R., & Hari, D. B. N. V. Evaluation of in vitro anticancer activity of hydroalcoholic extract of *Tabernaemontana divaricata*. *Asian J. Pharm. Clin. Res.*, 2012; 5.
17. Hartati, S., Suparmo, Santoso, U., & Marsono, Y. Antioxidant activity and in vitro inhibition human plasma LDL oxidation of defatted rice bran var. Menthikwangi extract. *Int. Food Res. J.*, 2017; 24(4): 1651–1659.
18. Uraji, M., Kimura, M., Inoue, Y., Kawakami, K., Kumagai, Y., Harazono, K., & Hatanaka, T. Enzymatic production of ferulic acid from defatted rice bran by using a combination of bacterial enzymes. *Appl. Biochem. Biotechnol.*, 2013; 171(5): 1085–1093.
19. Sing, S. X., Lee, H. H., Wong, S. C., Bong, C. F. J., & Yiu, P. H. Ferulic acid, gamma oryzanol and GABA content in whole grain rice and their variation with bran colour. *Emir. J. Food Agric.*, 2015; 27(9): 706–711.
20. Jayashree, J., Priya, D., Karthikeyan, S., & Babu, N. G. R. (2017). Production and Characterization of Ferulic Acid from Pineapple Waste and Its Anticancer Activity Using HeLa cell Line. *Int. J. innov.*, 2017; 6(3).
21. Nakayama, H., Nakahara, M., Matsugi, E., Soda, M., Hattori, T., Hara, K., Sami, A., Kusumoto, C., Higashiyama, S., & Kitaichi, K. Protective Effect of Ferulic Acid against Hydrogen Peroxide Induced Apoptosis in PC12 Cells. *Molecules (Basel, Switzerland)*, 2020; 26(1).
22. Bezerra, G. S. N., Pereira, M. A. V., Ostrosky, E. A., Barbosa, E. G., de Moura, M. de F. V., Ferrari, M., Cícero, F.S.A., Paula, A., & Gomes, A. P. B. (2017). Compatibility study between ferulic acid and excipients used in cosmetic formulations by TG/DTG, DSC and FTIR. *J. Therm. Anal. Calorim.*, 2017; 127(2): 1683–1691.
23. Kanski, J., Aksenova, M., Stoyanova, A., & Butterfield, D. A. Ferulic acid antioxidant protection against hydroxyl and peroxy radical oxidation in synaptosomal and neuronal cell culture systems in vitro: Structure-activity studies. *J. Nutr. Biochem.*, 2002; 13(5): 273–281.
24. Sargent, J. M. The use of the MTT assay to study drug resistance in fresh tumour samples. *Recent Results Cancer* 38002





**Avanthi et al.,**

Res, 2003 Vol. 161, pp. 13–25.

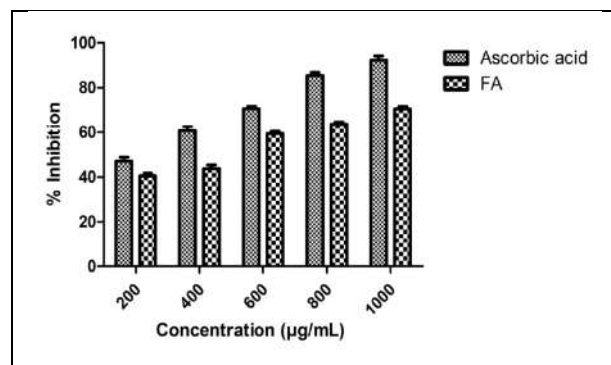
25. Nasr Bouzaiene, N., Kilani Jaziri, S., Kovacic, H., Chekir-Ghedira, L., Ghedira, K., & Luis, J. The effects of caffeic, coumaric and ferulic acids on proliferation, superoxide production, adhesion and migration of human tumor cells in vitro. *Eur. J. Pharmacol.*, 2015; 766, 99–105.

26. Elkhazendar, M., Chalak, J., El-Huneidi, W., Vinod, A., Abdel-Rahman, W. M., & Abu-Gharbieh, E. Antiproliferative and proapoptotic activities of ferulic acid in breast and liver cancer cell lines. *Trop. J. Pharm. Res.*, 2019; 18(12): 2571–2576.

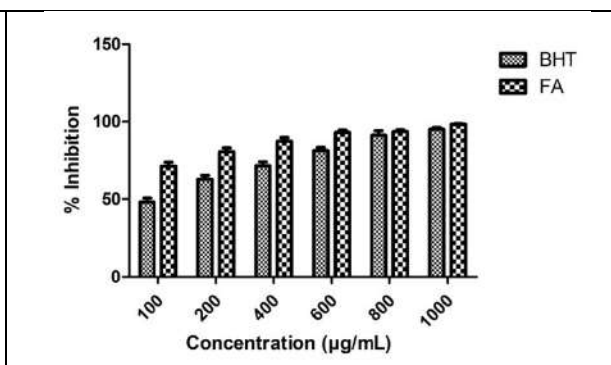
27. Thakkar, A., Chenreddy, S., Wang, J., & Prabhu, S. Ferulic acid combined with aspirin demonstrates chemopreventive potential towards pancreatic cancer when delivered using chitosan-coated solid-lipid nanoparticles. *Cell Biosci.*, 2015;5(1): 46.

28. Gao, J., Yu, H., Guo, W., Kong, Y., Gu, lina, Li, Q., Yang, S., Zhang, Y., & Wang, Y. The anticancer effects of ferulic acid is associated with induction of cell cycle arrest and autophagy in cervical cancer cells. *Cancer Cell Int.*, 2018; 18(1): 102.

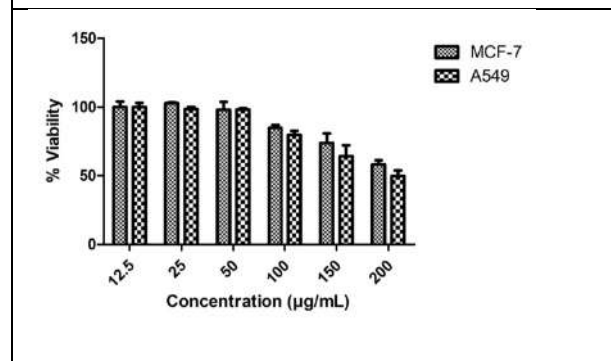
29. Ferguson, L. R., Lim, I. F., Pearson, A. E., Ralph, J., & Harris, P. J. (2003). Bacterial antimutagenesis by hydroxycinnamic acids from plant cell walls. *Mutat Res Genet Toxicol Environ Mutagen*, 2003; 542(1–2): 49–58.



**Figure 1: Antioxidant activity of Ferulic acid by DPPH radical scavenging assay**  
 Mean ±Standard deviation of three independent estimations; FA – Ferulic Acid



**Figure 2: Antioxidant activity of Ferulic Acid by hydrogen peroxide radical scavenging assay**  
 Mean ±Standard deviation of three independent estimations, BHT – Butylated hydroxy toluene; FA – Ferulic Acid



**Figure 3: In vitro anticancer activity of ferulic acid on lung and breast cancer cell lines**  
 Mean ±Standard deviation of three independent estimations



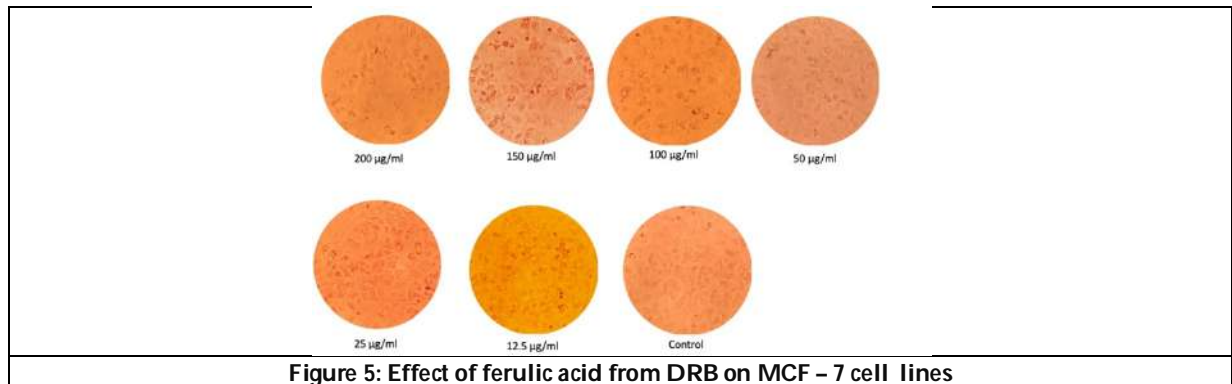
**Figure 4: Effect of ferulic acid from DRB on A549 cell line**







**Avanthi et al.,**





## Comparative Analysis on English Grammar and Spelling Correction using Artificial Intelligence Techniques

Ranjitha M<sup>1\*</sup> and Nikhil Hari<sup>2</sup>

<sup>1</sup>Associate Professor, Department of Computer Science [PG], Kristu Jayanti College (Autonomous), Bengaluru, Karnataka, India.

<sup>2</sup>Department of Computer Science [PG], Kristu Jayanti College (Autonomous), Bengaluru, Karnataka, India.

Received: 15 Dec 2021

Revised: 27 Dec 2021

Accepted: 18 Jan 2022

### \*Address for Correspondence

#### Ranjitha M

Associate Professor,  
Department of Computer Science [PG],  
Kristu Jayanti College (Autonomous),  
Bengaluru, Karnataka, India  
Email: ranjitha.m@kristujayanti.com



This is an Open Access Journal / article distributed under the terms of the **Creative Commons Attribution License** (CC BY-NC-ND 3.0) which permits unrestricted use, distribution, and reproduction in any medium, provided the original work is properly cited. All rights reserved.

### ABSTRACT

Word correction has reached a very good state today, but one cannot say the same about grammar. This has to do with the fact that grammar correction and checking is more complex than word checking, as there can be a near-infinite combination of valid sentences, and more of incorrect sentences. A phrase-based or Gerund-based correction system simplifies the process but does not fix all the issues with the sentence, such as phrase-level construction and matching. Therefore, systems are employed to understand the context from the sentence and predict the error. Many methods exist to detect and autocorrect incorrectly formed sentences that are open source such as Language Tool, and proprietary tools like Microsoft Word or Grammarly. However, these systems are far from perfect. Various tools like machine learning and deep learning that are available today, try to address this issue, but such systems are highly unpredictable and need long training time. This paper focuses on the various methods of auto-correction, and their efficiency, the various drawbacks each of these systems have, such as lack of personality of the individual who is composing the message, and how others work on them, while learning why a perfect auto-correction algorithm is hard to design. Finally, comparative analysis is performed on selected systems, to learn on their drawbacks, so that a better system can be devised.

**Keywords:** English, Grammar, Spelling, Parser, Artificial Intelligence





**Ranjitha and Nikhil Hari**

## INTRODUCTION

Grammar correction has found various applications in today's world, where one types more than handwriting. To proof a document, people often type in a copy of what they are communicating on a correction software such as Microsoft Word or Grammarly. These tools often have many features to detect erroneous sentences and offer suggestions to the user. They often correct the usage of words with apostrophe such as 'we're', 'it's' and correct usage of 'your' or correcting to the right form of a verb [1]. However, there have not been a huge break through where sentences are perfectly corrected without any errors. Technology used to correct grammar can be as simple as using CFG parser, to as complex as neural networks. This paper attempts to explore the mentioned technologies and relevant ones in between and explore the differences and the generational jump between each technology. The paper explores the various drawbacks on each of them and can serve as a reference for future designs.

## LITERATURE REVIEW

Madi and Al-Khalifa [2] discuss about grammatical error testing as a method to seek and sometimes modify erroneous words in some text. Many techniques have been used for identifying and modifying text in many languages. Methods that have been used are based on rule, syntax, statistics, classification and neural network. Ratna *et al* [3] developed a Java-based system for grading essays in Indonesian language using a more efficient and optimal algorithm. This algorithm consisted of 4 stages (Fig 1). The first stage is Latent Semantic Analysis (LSA), which is used to attain and accomplish the contextual relation of word's meaning in a text. The second stage incorporates Single Value Decomposition (SVD) to make scatter variance from the derived relations. SVD finds where variances show the most, and therefore is used to find the finest method to get the original data by reduced dimensions. The third stage is Latent Semantic Indexing (LSI) which is an indexing and retrieval method to classify patterns in relation amid terms and concepts contained in unstructured text collection and results with a vector representing the text. The last stage is Cosine Similarity Measurement (CSM) to achieve similarity value from the text and answer document. To overcome problems curtailed from grammar and vocabulary, an auto-correction technique is proposed to check a word from word library for equalization of word with same or no specific meaning. Then, Jaro-Winkler distance algorithm (Eqn. 1) is used to detect word errors caused by mistake while typing. With the distance, determination of two strings of word that is similar is possible. This is predominantly significant when scanning text with typos, as it will influence the result from LSA. With this system, the value obtained is like the value obtained from human rate. Using a word library consisting of 97 words for synonym check and 204 function words, the attained accuracy is  $85.246\% \pm 13.129$ .

$$d_j = \begin{cases} 0 & \text{if } m = 0 \\ \frac{1}{3} \left( \frac{m}{|s_1|} + \frac{m}{|s_2|} + \frac{m-t}{m} \right) & \text{otherwise} \end{cases}$$

### Eqn. 1. Jaro-Wrinkler Distance Equation

In recent years, there has been an exponential increase in the number of complicated documents and texts that necessitates a deeper understanding of machine learning methods to be able to accurately classify texts in many applications. Many machine learning methodologies have attained exceptional results in natural language processing. The accuracy of these learning algorithms bank on their capacity to recognize complex models and non-linear relationships within data [4]. From this, it is seen that spelling correction systems have seen a huge progress and are almost perfect. However, there are a lot of challenges when it comes to correcting grammar.

### CFG Parser

V. Vrublevskyi and O. Marchenko [4] try to develop an efficient adaptable model for evaluating syntactical compositions of natural language. The standard of a context-free grammar was chosen for the representation of grammar rules of the English language. Based on this, they built an error correction grammar. The Early parser was



**Ranjitha and Nikhil Hari**

used with an error accumulating algorithm to bring flexibility in the model. As an outcome, an appropriate instrument for natural language parsing was created. It can be used for grammar checking and correcting. The experiments carried out proved the efficiency and hence the correctness of proposed model.

**Correcting Misuse of Verb Forms**

John Lee and Stephanie Seneff [1] suggested a method to correct verbs to their right form using parse trees. This can help non-native speakers, while the tree itself can improve recall and irregularities. The author goes on to explain what the different forms of verbs in English are, and how the system is expected to detect them. They explain that an English verb is affected by the five forms, as shown in Table 1. This work focuses on these common errors and removes confusion when choosing the correct form. The errors come under roughly semantic and syntactic. Semantic errors being the ones that deal with bad choice of tense, aspect, voice, or mood, while syntactic errors often deal with the incorrect version of the verb. The authors further divide it into a few more types, namely subject-verb, auxiliary agreement, and complementation, the former being an error when the verb is not correctly referring to the number and/or person. Complementation is an error caused when a non-finite clause serves as an opposite to the verb following it. The authors discuss about the ambiguities. One such example is when a verb belongs to the two or three categories listed above. This can lead to degraded quality of parsing. Another issue is over-generalisation. To fix this, the authors propose a n-gram count. The results were evaluated based on how accurate, how well the parse tree could recall, how precisely the parse could detect errors, and how correct the change was. The researchers lay baselines for the tests, and they have achieved 98% in auxiliary agreement and 97% for subject-verb agreement. The paper concludes with how the tree patterns may expand to unusual patterns, but this can help with the corrections, but this affects over-generation of hypothesised corrections. N-Grams seems to have been a great filter to provide a good solution.

**Arboretum**

Another field where grammar correction can be explored on is CALL or Computer Assisted Language Learning. On InSTIL/ICALL Symposium, Bender et al spoke about "Arboretum" [6] in which they stated that their goal was to connect misinterpreted surface level strings (as in CFG) to complete and correct semantic representations. They developed this system using LKB parser and generator, and English Resource Grammar. The system then provides an interactive experience for the reader, while letting the learner's interest and provides motivation for practice. In the paper, Bender and others use a concept of "mal-rules". These are categorised into three primary classes: (i) Constructions that are connected, but is incorrect as they have certain constraints, (ii) Lexical rules that are connected, but are wrong in context, and (iii) Lexical items that inherit rules, but is incorrect. The authors added a few rules to improve the performance which serves as proposal for the base. Although this is not a great deal for a human to understand, it often is easy for a native speaker. Since the paper covers learners, further processing was required. This leads to confusion, and will often confuse new learners, letting them assume that they might have made an error. The authors go on to talk about their best-first generation strategy, called "aligned generation", in which they generate a sentence that tries to be very similar to a template. It uses a scoring strategy, and it prioritises general tasks in LKB's agenda-driven chart generator. This results in a priority for each task, and they are categorised from High to Low. The first strategy generates a bunch of subtrees in a single depth. In many cases, the mal rules will still be present which cannot be matched by the generator. To evaluate this, the authors refer to Matthews', and Menzel's, as they state that using mal rules in precision grammar is not advisable, especially in the case of CALL, as they produce too many errors. The authors instead recommend a more widely used relaxation technique. The authors reason out that the strategy they adopted would be interesting to explore. They proceed to evaluate their strategy with Aligned Generations. They found that their system had quite a lot of failures, including classifying the strings to right classes, and lexical entries not parsing as they expected.

**Morphosyntactic Parser**

Gregor Thurmair [5] discuss about the basic issues one must overcome in a morphosyntactic parser to use it for grammar and style checking. Author proposes a method based on METAL grammar formalism which is lenient with levelling, scoring and offers fallback rules. The author goes on to distinguish grammar and style checking. Grammar



**Ranjitha and Nikhil Hari**

tries to find errors and ill-formed lines, which is a mistake that should be corrected, while style can be a bit more laid-back when considering to correct such statement, and it corrects any divergence from the style by the speaker. The author gives a few examples and proceeds to talk about “cirulusvitiosus”, a parser that would detect errors and interpret the sentence. The research work, considers competing parses that will throw if there is a complex sentence, and a diagnosis for the same can be chosen depending on the parser. The interpreting application should not agree to the user to pick a better outcome, but rather find the best one. It goes on to prescribe properties of an ideal parser for grammar checking, where it states that the parser should be able to allow analysis of parse failures, the diagnosis of the same should know what the issues are. Author calls this a “two step approach”, and CRITIQUE system with various special fallback rules a “one step approach”. The paper proceeds to emphasize why METAL grammar can be the basic and ideal tool and shows them with a few examples of English sentences converted from German.

**Pattern Based Grammar Checker with HSPG Grammars**

Crysmann et al [6] provide a solution by using a hybrid approach, using pattern matching and HPSG grammar and style for both German and English. The researchers introduce the topic by talking about how multilingual documentation is on high demand and controlling the quality of the documents become hard. This tool would help authors and facilitate translation of language. The approach they took have two goals – improving the precision and recall and then get error corrections for grammar and style. Error detection is done by mal rules. Since they are exact model errors, the errors are parsed as they are encountered. They use two enlarged HPSG grammars for the languages, with mal-rules for error types that were problematic from pattern-based systems. As described by Thurmair, these are localised to an individual and is not something that they would prefer. They show a few examples of the same and continue by differentiating integrated and parallel scenarios. In the latter, the pattern system and parser run independently. This means that all the sentences are parsed even if pattern system does not flag an issue. They proceed to demonstrate the generations, as this is a deep processing system. The team discovered that the two areas to focus are: If the non-native speaker highlighting the error is not sufficient, as they are not familiar with the language. The other being the fact that especially stylistic grammar considers rearrangement of the entire sentence. The team introduces a tool to check the frequency of the errors, and based on this, they report the accuracy. The team shows a few results and concludes by stating how the reduced search space for parsing improves performance. The hybrid approach is very convenient and generic, however, if the baseline is altered, the system can be used in other parser systems.

**Neural Machine Translation**

While Zheng Yuan and Ted Briscoe [7] wrote their work targeting GEC (Grammatical Error Correction), it still can be considered as a valid application for grammar correction. GEC, as per the authors, is the process of correcting grammatical errors that non-native speakers of a language make. The idea was to translate an incorrect sentence to a correct one, by taking care of all the errors together. They go on to talk about the various recent versions of Neural Machine Translation models that were developed, and unlike Simple Machine Translation, NMT learns from a single neural network which translates a sentence. The authors consider the fact that NMTs have smaller and limited vocabulary size of source, and how complex the training gets. The authors propose a simple change that is, to replace the words that seem incorrect “out-of-vocabulary” with symbol UNK. The problems get complex as the non-native speaker may use mis-spelled words or words that are rare in the native language. The authors go on to talk about NMT systems and how they used an encoder-decoder system. Using a few references, they also attempt handling the rare word problem. They have used word-alignment algorithms, such as aligning UNK in target with origins using an unsupervised aligner and using word-level translation model to translate words. They further discuss about the various models that they have used and compared their performance levels. Further, they explain what the dataset they use contains. The paper is successful with the test with NMT 50K-80K Meteor taking the throne, but they have an issue with the unknown word problem.

**Malay Declarative Sentence**

Moving away from English, it is seen that the researchers Muhamad Noor and Z. Binti Jamaludin initiated sentence parse tree visualisations [10] to help in understanding sentence structure in many languages, especially in English.



**Ranjitha and Nikhil Hari**

Among the applications introduced, phpSyntaxTree and RSyntaxTree allow users to envisage an English sentence through online interface. In Malaysia, language research in sentence parse tree visualization for Malay (BM-Bovel Movement) still has not fascinated many researchers to develop a prototype as has been done in English. The parsers will generate a parse tree through the parsing process. Based on the type of parsers, methods can be stretched to produce sentence parse tree visualizations for BM. Parsers for defining sentence structure need to be included in visualization methods. Visualization methods comprises of (i) tokenising, (ii) checking the total number of words, (iii) assigning word class, (iv) checking spelling or conjunctions, (v) checking and aligning with formula, (vi) suggestion or visualization (vii) word attributes and (viii) visualization from a corpus. A prototype for the methods introduced is still under the development and improvement process. However, output generated from the development process in validating the sentence, suggesting corrections for incorrect sentences, and generating a parse tree has had good output results.

**Comparative Analysis****Basic Parsers and Rule-based Systems**

Thirumair defines properties of a parser for style and grammar checking [5]. In the paper, the author recommends a few features that a parser system should have. They mainly are,

- The system must allow diagnosis of failures, and how it can be fixed. The following systems use systems that help the author analyse the issues with their system.
- The diagnostic system should be aware of what or where the issue crept in. In LKB parsers, for example, the author states that most of the errors are determiner errors.
- When such issues arise, the parser should be aware on how to resolve these issues and should be able to recover from these errors using fall-back rules. They should only fire when the issues are found.
- The ideal way to apply the fall-back system would be to use a best-first strategy. Both the following parsers have used such systems.
- The last point is to analyse the changes that the system makes to the input, what sort of correction is to be made should be purely detected by the correction system. The proposal was to use operations such as addition, changing, or deletion of nodes, value-pairs, etc. from the tree to make the correction. CFG or Context Free grammar does not assume any context between sentences that the parser takes in. This means, that every sentence in a paragraph is mutually exclusive. Although this type of parsers can easily detect and find errors, and is fully Turing-complete, human language is not. CFG parsing system can be easily used to analyse grammar when context is not a concern. CFG Parsing in this paper focuses on the structure of the sentence built with parts of speech tags. This helps the CFG recognise the errors in the statements. The task now is to find if the sentence is satisfied by the generated language. Earley algorithm is used to analyse and parse the grammar. Earley sets also help accomplish picking the right part of speech in sentences, as Earley algorithm is constructed in ascending order (not lexical order). The system gives an advantage of generating many parse trees, which can help determine the correct sentence easily.

LKB parsing, in contrary, prefers making strong rules about how the tree will be generated. The implementation on Arboretum [8] used Mal-rules system to find ill-surfaced strings. From the same paper, we see that better evaluation strategies give better and sensible results. Aligned generation is the scoring strategy they use to analyse the results of LKB parsing. Their testing shows that determiner errors are the ones that happen the most frequently. Using the aligned generation strategy, they claim that their success rate was 93.8% with correct sentences. At the end, they conclude to state that going forward to the next generation of NLP would be using statistical models, and machine learning techniques.

**Machine Learning and Statistical Models**

Writing rule-based systems can often get tedious, and especially in English language, there can be a lot of "fall-back" rules for various scenarios, which can often be missed out even by a linguistic expert and having a lot of such rules becomes harder to implement because of conflicts. In such scenarios, Mathematical models can help, as such models learn from existing data "corpus". Rule-based systems such as [9] consider for all errors that a system can generate. In this paper, the authors try and build a system that can account for errors and classify those errors into types. They





### Ranjitha and Nikhil Hari

then go on to describe how the various errors can be handled. In their paper, they state that supervised learning technique is the best way to train an NLP system. The paper also suggests that considering a hybrid approach --- one with Rule base for simple errors and machine learning system for analysing the more complex errors would be better. Just like the previous systems, an evaluation system would help analyse how good the system is. They explain that a hybrid system can do a better job.

An approach like [9] using Neural Machine Translators uses a simpler strategy --- replace all out-of-vocabulary words with a UNK symbol. These systems apply an encoder-decoder system. The encoder (Eqn. 2) reads the entire sentence and converts that into vector, which can then be used in a mathematical model for various purposes. This system uses a decoder (Eqn 3.) that then compares the sentence with words predicted by it. The problem that this system has is that it cannot handle rare words, such as proper nouns. The system developed by the authors perform correction in two steps --- converting the UNK symbols into correct words in the sentence using an unsupervised aligner and develop a system that can convert the said sentence into post-processed words. Their evaluation criteria were to use M2 Scorer. They proceed to show the results, and they were clearly better.

$$x = (x_1, x_2, \dots, x_T) \rightarrow c = q(h_1, h_2, \dots, h_T)$$

$$p(y) = \prod_{t=1}^T p(y_t | \{y_1, y_2, \dots, y_{t-1}\}, c)$$

$$= \prod_{t=1}^T g(y_{t-1}, s_t, c)$$

#### Eqn 2 and 3. Encoder and Decoder Models

These literatures prove that Machine learning models can be used to perform various correction tasks, however, as [11] points out, hybrid systems can be superior method to perform grammatical corrections.

#### Hybrid Approach

A hybrid approach to grammar and style checking was presented in [6]. They use a shallow grammar and style checking system, along with deep parser for linguistic grammatical errors. The approach they followed was to (i) improve precision of rule-based systems and then correcting style errors using syntactic context, and (ii) generate corrections for both. Just like [6], they used the MAL-rules approach to correct errors. These rules can detect what the errors are efficiently and can be parsed by the grammar. The paper also suggests that machine translation models don't work well with machine translation systems. The tests prove that deep systems performed about 21% better than shallow systems in English. They claim that the PET parser, the deep parser, gives an astounding 86.1% coverage.

#### Common Issues and Conclusions

##### POS Structures in CFG Parser

As discussed in the CFG Parser [4] approach, the objective of the experiment was to use parts of speech (POS) tags to structure the statements. The authors also used Earley algorithm to parse and analyse the generated CFG. While it proves that it can be done to a certain extent, the results do not show a perfect result. The authors go on to explain how this probably was because of the only-POS approach, and they add a state-of-art system in their future work.

##### LKB and Classification

Syntactic constructions seemed to be a small contribution to the test, while lexical rules which are sensible to the context, but maybe a mismatch from another context is marked erroneous and incorrect lexical inheritance seemed to be the bigger culprit. [8]

##### Issues with Mal-rules and its complexities

Few researchers argue that adding mal rules to precision grammar is a very ineffective way to come about the topic, although some papers [8][6] prove that it can be used to produce better results.



**Ranjitha and Nikhil Hari****Deeper Trees**

The literature also talks about how parsers go into deep trees [1], which is extremely undesirable as it poses to be both memory and time hog; the parser otherwise poses as a very viable solution. While CFG Parsing [4] used trees, they had shorter and more predictable trees, which did avoid the issue. Splitting trees into multiple trees is achieved due to the lack of context, or link between the statements.

**Rare or Foreign Words, Proper Nouns**

This issue was attempted to fix in NMT [7] where the authors considered this very issue and built a system around it. Although they were not 100% successful, they show a progress from what the state before this system existed is.

**Conflicts between Grammar and Style Check**

As Gregor Thurmair [5] states in his research work, grammar is stringy and has rules, anything going against it is an error, however a style is personalised to the speaker's approach of talking. At times, users can be annoyed about how the sentences are restructured and it goes totally out of their style. A golden system must consider this.

**CONCLUSION**

Grammar checking systems have been in development from a very long time, and it finds its applications in various arena. While many spell-check systems exist, there are very few systems that are capable of grammar correction today. NLP, the broader category that such systems come under, has gained vast popularity these days, be it text classification problem, sentiment analysis, or grammar checking. This paper highlights few breakthroughs in the technology. It is seen that the various approaches that is used to correct grammar, especially in English were Basic Parsers and Rule-based systems which tries to make specific rules for various situations and solve them based on fall-back rules, Machine Learning and Statistical/Mathematical models. This study tries to generalise the problem so that the solution can be applied to all statements, and finally we look at a hybrid system that combines the best of rule based Mal-rules and deep systems. Various drawbacks that the systems pose, namely using only POS approach and lack of context in CFG parser, how LKB parsers can get erroneous context, how mal rules can fail at times, and sometimes, the generated trees can be too deep, and how styles can often give a different meaning to the machine is also analysed. In this review, many viable solutions to the problem were looked upon. A few issues were drawn from the same. These problems could pose as a big hurdle to the development in the text processing field.

**REFERENCES**

1. J.Lee and S. Seneff, "Correcting Misuse of Verb Forms," in Proceedings of ACL-08: HLT, Columbus, 2008.
2. N. Madi and H. S. Al-Khalifa, "Grammatical error checking systems: a review of approaches and emerging directions," in 2018 Thirteenth International Conference on Digital Information Management (ICDIM), 2018.
3. Z. Yuan and T. Briscoe, "Grammatical error correction using neural machine translation," in Proceedings of the 2016 Conference of the North American Chapter of the Association for Computational Linguistics: Human Language Technologies, 2016.
4. V. Vrublevskiy and O. Marchenko, "Grammar Error Correcting by the Means of CFG Parser," in 2019 IEEE International Conference on Advanced Trends in Information Theory (ATIT), 2019.
5. G. Thurmair, "Parsing for Grammar and Style Checking," in (COLING) 1990 Volume 2: Papers presented to the 13th International Conference on Computational Linguistics, 1990.
6. G. Sidorov, A. Gupta, M. Tozer, D. Catala, A. Catena and S. Fuentes, "Rule-based System for Automatic Grammar Correction Using Syntactic N-grams for English Language Learning (L2)," in Proceedings of the Seventeenth Conference on Computational Natural Language Learning: Shared Task, Sofia, 2013.
7. A. A. P. Ratna, R. Sanjaya, T. Wirianata and P. D. Purnamasari, "Word level auto-correction for latent semantic analysis based essay grading system," in 2017 15th International Conference on Quality in Research (QIR): International Symposium on Electrical and Computer Engineering, 2017.





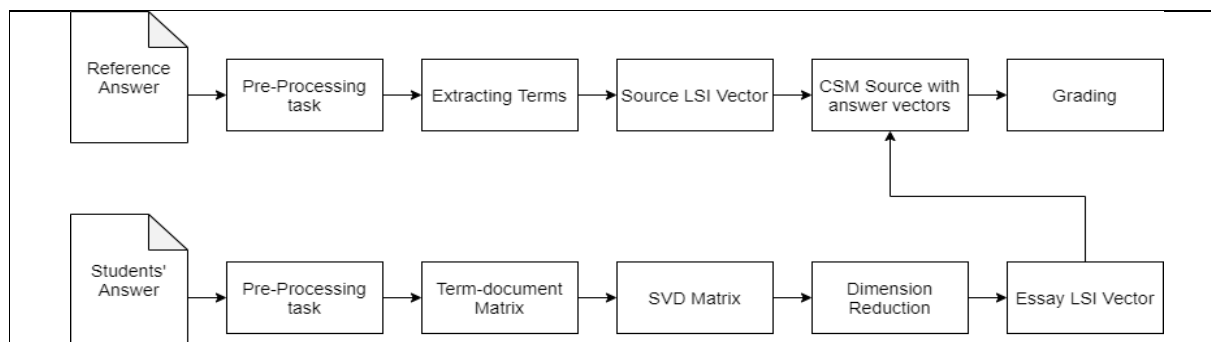


**Ranjitha and Nikhil Hari**

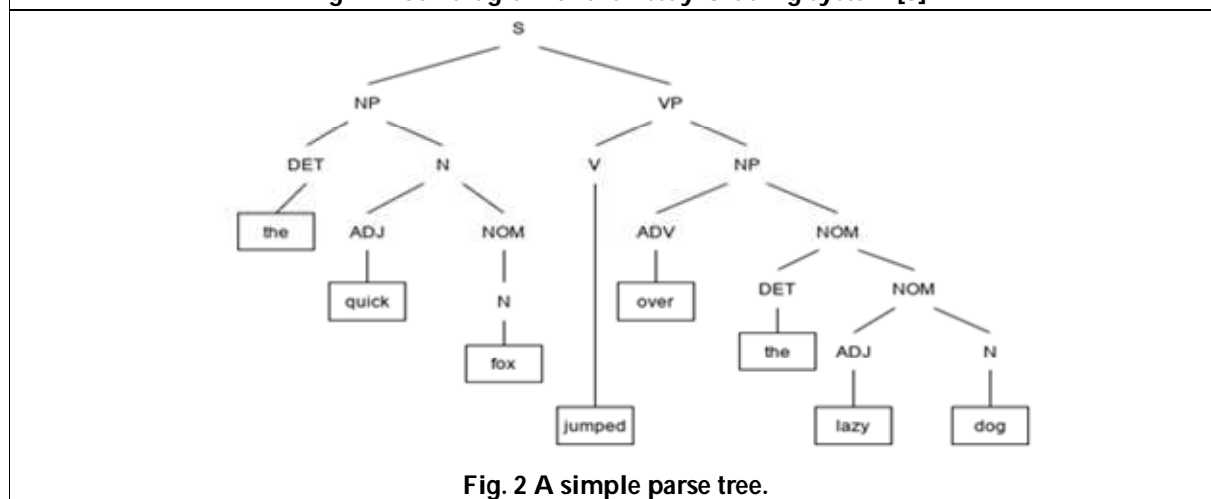
8. K. Kowsari, K. J. Meimandi, M. Heidarysafa and S. Mendu, "LE Barnes in DE Brown," Text Classification Algorithms: A Survey, vol. 10, 2019.
9. Foster, "Treebanks gone bad," International Journal of Document Analysis and Recognition (IJ DAR), vol. 10, p. 129-145, 2007.
10. B. Crysmann, N. Bertomeu, P. Adolphs, D. Flickinger and T. Klüwer, "Hybrid Processing for Grammar and Style Checking," in Proceedings of the 22nd International Conference on Computational Linguistics (Coling 2008), Manchester, 2008.
11. Z. bintiJamaludin and others, "Malay Declarative Sentence: visualization and sentence correction," in 2012 IEEE Conference on Open Systems, 2012.
12. E. M. Bender, D. Flickinger, S. Oepen, A. Walsh and T. Baldwin, "Arboretum: Using a precision grammar for grammar checking in CALL," in Instil/ical symposium 2004, 2004.

**Table 1. The five forms of verbs**

Form	Example
base (bare)	speak
base (infinitive)	to speak
third person singular	speaks
past	spoke
-ing participle	speaking
-ed participle	spoken



**Fig 1. Block diagram of the Essay Grading system [3]**



**Fig. 2 A simple parse tree.**





## Methods for Point-based Feature Extraction in Palmprint Biometric Systems

Sathish R<sup>1\*</sup>, Baskar D<sup>2</sup> and Vinod Kumar D<sup>3</sup>

<sup>1</sup>Research Scholar, Assistant Professor, Department of Electrical and Electronics Engineering, Vinayaka Mission's Kirupananda Variyar Engineering College, Vinayaka Mission's Research Foundation (Deemed to be University), Salem, Tamil Nadu, India.

<sup>2</sup>Assistant Professor, Electrical and Electronics Engineering, Annai Teresa College of Engineering, Viluppuram, Tamil Nadu, India.

<sup>3</sup>Professor and Head, Biomedical Engineering, Vinayaka Mission's Kirupananda Variyar Engineering College, Vinayaka Mission's Research Foundation (Deemed to be University), Salem, Tamil Nadu, India.

Received: 20 Nov 2021

Revised: 21 Dec 2021

Accepted: 13 Jan 2022

### \*Address for Correspondence

#### Sathish R

Research Scholar, Assistant Professor,  
Department of Electrical and Electronics Engineering,  
Vinayaka Mission's Kirupananda Variyar Engineering College,  
Vinayaka Mission's Research Foundation (Deemed to be University),  
Salem, Tamil Nadu, India.



This is an Open Access Journal / article distributed under the terms of the **Creative Commons Attribution License** (CC BY-NC-ND 3.0) which permits unrestricted use, distribution, and reproduction in any medium, provided the original work is properly cited. All rights reserved.

### ABSTRACT

Biometrics are measured in order to authenticate or identify the identification of an individual. A person's palmprint is one of the physiological aspects of the human body that has received attention from the scientific community as a means of security. Investigations were conducted at the Chinese Academy of Sciences Institute of Automation (CASIA), which was funded by the Chinese government. Corners are well-known for being the locations where intensity shifts in all directions at once. Corner points are a type of palmprint characteristic that can be found in some palmprints. The selection and discussion of efficient point-based feature extraction algorithms for usage in a variety of object recognition applications is presented. Those procedures have been tested on palmprints, and the effectiveness of each has been determined. The SUSAN Operator, Wavelet-based Salient Point Detection, Trajkovic and Hedley Corner Detection, and Forstner Operator are used to extract the palmprint Point characteristics from the palmprint image. In this case, the Forstner Operator performs admirably, achieving 98.35 percent accuracy for 1 percent of FAR and 98.7 percent accuracy for 2 percent of FAR accuracy.

**Keywords** : Biometrics, Palmprint, Authentication, Object Recognition



**Sathish et al.,**

## INTRODUCTION

In Greek, the words "Bio" and "Metrics" imply "life" and "metrics" means "to measure." The term "biometrics" derives from these two words. Biometrics are measured in order to authenticate or identify the identification of an individual. A biometrics system is used to automatically recognize and identify a specific individual. Biometrics is employed as a range of identity entrée organisation and control methods in the information system, according to precise standards. It is also used to identify individuals who are part of groups that are being watched. Biometrics can be divided into two categories: Physiological characteristics and Behavioral characteristics.

### Palmpoint

The palmpoint is one of the physiological properties of the human being. It has universal appeal, is one-of-a-kind, is permanent, is collectible, is consistent, is similar, is inimitable, and is tamper-proof. Because every human possesses a palmpoint, palmpoint is considered universal. It is one-of-a-kind since every palmpoint is distinct from the others. Kong et al. [6] demonstrated that the palmpoint contains a wealth of genetically unrelated information that can be used to distinguish identical twins. When compared to other forms of identification, a palmpoint is permanent or inseparable from the individual. Because it does not alter considerably over time [1,2,3], palmpoints are simple to capture and consistent in their results. Digital comparisons with other people can be made with the help of this tool. Because of its size and abundance of features, the palmpoint is difficult to replicate. Because it cannot be modified and because it is difficult to conceal, the palmpoint is tamper-resistant.

Palmpoint has a plethora of functions. Geometry features, point features, line features, texture features, and statistical characteristics are all included in this category. Palmpoint geometrical characteristics include the width of the palm, the length of the palm, and the area of the palm. Hand geometry biometric systems are often comprised of palmpoint geometry features combined with finger geometry features to generate a hand geometry biometric system. Because the hand geometry of adults is very similar, a hand geometry biometric system will not be able to attain high levels of accuracy in identifying them.

Palmpoint point features are the points that may be found on a person's palmpoint and that can be used to identify them as a result of their fingerprint. The terms datum points, line junction points, delta points, end line points, and others are all used to describe these points. Palmpoint point characteristics necessitate the use of a high-resolution palmpoint image in order to collect the necessary points.

### Point-Based Operators

When it comes to feature detection and the development of high-accuracy object measurement, the Forstner operator is utilised [4,57]. It is also used for automatic calibration of colour digital cameras [8], and it has produced promising results. Although computationally intensive, Harris and SUSAN are promising approaches that can produce high-quality features despite the fact that they are computationally intensive [9]. It is discussed in [10] that the challenge of real-time 3D model-based tracking by combining point-based and edge-based tracking systems by employing the SUSAN Method can be solved by combining point-based and edge-based tracking systems. In many contemporary image retrieval and object detection systems, computation of limited features at points of interest is a critical component of the algorithm. It was specifically designed for image retrieval applications [11], and it is a salient point detector that recovers points where differences occur in the image, regardless of whether or not they are corner-like. With the wavelet transform as a foundation, the detector is capable of detecting both global and local fluctuations [12]. It primarily introduces the orthogonal three-direction chain code (3OT) and applies it in corner detection of hand gesture using Trajkovic and Hedley Corner Detector [13], where it was discovered that the Trajkovic detector produced decent precision while operating at a much faster computational rate, which is more encouraging when it comes to high-speed appliance. Although the Trajkovic cornerness quantification was developed using intensity differencing for optical imaging, it is not ideal for synthetic aperture radar (SAR) imagery, which suffers from multiplicative speckle noise [14], which is a problem for SAR imagery. The efficiency of these whole operators has





**Sathish et al.,**

been established for a variety of computer vision applications, but these characteristics have not been examined for feature-rich objects such as palmprints. A task has been set for this study work: to investigate the effectiveness of these features in the context of a highly secure biometric system.

### Point Detection for Palmprint

Corners are well-known for being the locations where intensity shifts in all directions at once. Corner points are a type of palmprint characteristic that can be found in some palmprints. These characteristics can be recovered using the SUSAN operator, Wavelet-based salient point identification, Trajkovic and Hedley corner detector, and Forstner operator, among other methods of data analysis.

### 1SUSAN Operator

Smith and Brady [15] invented the SUSAN operator for image processing, which is now widely used. It is a method for detecting edges and corners that is accurate, noise-resistant, and extremely fast. It outperforms other operators in terms of performance and overcomes the most significant drawbacks of other approaches, such as the need for lengthy computation times. The SUSAN operator is based on the concept that each point of interest in an image will have associated with it a local area of similar brightness values, and that these areas can be used as a guide to assist in finding features of interest in an image such as corners and edges, as well as other features of interest such as lines and curves. The SUSAN operator searches for areas of similar brightness and, as a result, for interesting spots within a weighted circular window using a SUSAN algorithm. The nucleus of the search window is represented by the centre pixel in the search window. Using this method, the USAN is defined as the area within the window that has intensity values that are similar to those of the nucleus (Univalue Segment Assimilating Nucleus). As a result, a lower value for the USAN indicates a corner, as the central pixel would be significantly different from its surroundings. Following an evaluation of the data and the elimination of outliers, the local minima of the SUSANs (smallest USAN) are found to be valid points of interest. The following equation is used to compute a comparison between the brightness values of individual pixels:

$$o(\vec{p}, \vec{p}_0) = \begin{cases} 1 & \text{if } |I(\vec{p}) - I(\vec{p}_0)| \leq t_b \\ 0 & \text{if } |I(\vec{p}) - I(\vec{p}_0)| > t_b \end{cases} \quad (1)$$

where,  $p_0$  is the coordinates of the nucleus in the two-dimensional representation,  $p$  is the position of any other point within the circular window,  $I(p)$  is the brightness value of any pixel,  $t_b$  is the brightness value threshold, and  $o$  is the output of the comparison

$$n(\vec{p}_0) = \sum_p o(\vec{p}, \vec{p}_0) \quad (2)$$

$N(p_0)$  value is compared with a geometric threshold,  $g$ . The algorithm uses a threshold value in order to distinguish between features that make suitable interest points and non-suitable features. To find a corner in the image, the threshold value  $g$  is set to half of the maximum value of  $N(p_0)$ ,  $n_{max}$ . If  $n_{max} < g$  then it indicates corner existence.

### Wavelet-Based Salient Point Detection

It is a multi-resolution representation of image fluctuations at various scales that is used in the wavelet transform. A wavelet is a function that oscillates and has been attenuated. It is well known that the wavelet representation provides information on the variations in the signal at different scales of resolution. The goal is to extract salient points from a picture where there is some fluctuation in the signal at any resolution, in order to improve the quality of the image. The presence of a high wavelet coefficient at a coarse resolution indicates the presence of a region with significant global variability. By examining wavelet coefficients at higher resolutions, it is possible to identify a point that is representative of this global variation. The coefficient denotes the presence of two signal points. In order to identify a conspicuous point from this tracking, the point with the steepest gradient is chosen from among these two





**Sathish et al.,**

points. Saliency is defined as the sum of the absolute values of the wavelet coefficients in the track multiplied by the number of samples.

$$saliency = \sum_{k=1}^{-j} |C^{(k)}(W_{2^j} f(n))|, \log_2 N \leq j \leq -1 \quad (3)$$

where  $C(W_{2^j} f(n))$  is the wavelet coefficient, N is the length of the signal.

**Trajkovic and Hedley Corner Detector**

Corner operators invented by Miroslav Trajkovic and Mark Hedley in 1998 [16,17,18] are known as the Trajkovic and Hedley corner operators. Compared to other operators such as the Plessey operator, it was discovered that while the operator has a somewhat lower repeatability rate, the localisation is equivalent and even improved at intersections. The Trajkovic operator's cornerness measurement is calculated by taking into account a minute circular window and all of the lines that outdo through the centre of the circle. Centre of the circle is denoted by C and an illogical line that passes through C and interconnect the edge of the circular window at P and P'. Intensity at a point X is denoted by IX is summarized in Figure 1 and Different cases for the Trajkovic Operator are shown in Figure 2.

The cornerness measure for the Trajkovic operator is then given as:

$$C(x,y) = \min \left( (I_P - I_C)^2 + (I_{P'} - I_C)^2 \right), \forall P, P' \quad (4)$$

**Förstner Operator**

Since its introduction in 1987 by Förstner and Gülch, the Förstner Operator [15], which was invented by Förstner and Gülch, has been widely used in photogrammetry and computer vision applications. In designing this operator, the goal is to construct a quick operator for the recognition and precise positioning of discrete points, corners, and centres of circular image features, with a small amount of computation. Using the autocorrelation function A, the algorithm detects points of interest, edges, and regions of interest. Using a Gaussian window, the derivatives of A are computed and totaled over time. In this step, error ellipses are generated, and the interest points discovered are categorised as either points, edges, or regions based on the size and form parameters of each ellipse. Förstner calculates the size and shape of the error ellipses using two eigenvalues  $\lambda_1$  and  $\lambda_2$  as well as the inversion of A.

The error ellipse size is determined by:

$$w = \frac{1}{\lambda_1 + \lambda_2} = \frac{\det(A)}{\text{trace}(A)}, \quad w > 0 \quad (5)$$

The roundness of the ellipse is determined by:

$$q = 1 - \left( \frac{\lambda_1 - \lambda_2}{\lambda_1 + \lambda_2} \right)^2 = \frac{4 \cdot \det(A)}{\text{trace}(A)^2}, \quad 0 \leq q \leq 1 \quad (6)$$

**RESULT AND DISCUSSION**

During the pre-processing stage, the palmprint was extracted and the point-based feature extraction method was applied to it. Table (1-4) & Figure (3-6) depicts the point features for many feature extraction methods, each of which has its own set of point features. In addition to the Threshold vs FAR and FRR plot as well as Receiver Operating Curve (ROC) curves, the various point-based feature extraction methods are depicted in Figures [7-10] to allow for comparison.



**Sathish et al.,**

This section examines the graphs and tables that correspond to the various point-based detection methods. It is discovered that various FAR, FRR, threshold levels, and accuracy values exist. The best accuracy for each approach is described, as well as the most accurate method. It can be shown in Table 5 that the results obtained using the Forstner Operator are significantly better than those obtained using the other approaches. It obtains accuracy of 98.35 percent for 1 percent of FAR and 98.7 percent accuracy for 2 percent of FAR when using this method. For 5 percent and 10 percent FAR, the accuracy gained from other methods is significantly lower than 93 percent, respectively.

## CONCLUSION

Personal authentication with palmprint is becoming increasingly popular due to the fact that palmprint is a feature-rich and tamper-proof biometric that is being more widely used. In comparison to other biometrics, palmprint has several features that make it a superior biometric. These characteristics include universality, distinctness and permanence; collectability; performance; acceptability and circumvention. In terms of biometrics, the palmprint is a feature-rich biometric containing a variety of different sorts of attributes such as geometry attributes, line attributes, point attributes, texture attributes, and statistical attributes. The use of palmprint authentication in conjunction with other point-based approaches is explored in this section. All of the methods are put through their paces by programming them in MATLAB. When talking about authentication, it's important to remember that no one can guarantee that the process will be flawless (100 percent successful). There is a potential that a person will be falsely accepted or denied by the system. It's important to take into account all of these elements when discussing authentication methods and procedures. In truth, an increase in FAR results in less security or improper authentication because any individual might be considered as genuine, which is a well-known fact. The same is true for FRR; an erroneous rejection results in a longer period of time required for authentication by a genuine individual. It is presented how several performance measures, such as the false alarm rate (FAR), false rejection rate (ERR), and accuracy, can be used to evaluate the performance of a biometrics authentication system. The selection and discussion of efficient point-based feature extraction algorithms for usage in a variety of object recognition applications is presented. Each of these strategies is executed on a palmprint, and the effectiveness of each method is evaluated. According to the findings of the analysis, the results obtained using the Forstner Operator are much superior to those obtained using the other approaches. It obtains accuracy of 98.35 percent for 1 percent of FAR and accuracy of 98.7 percent for 2 percent of FAR when using this method. For 5 percent and 10 percent FAR, the accuracy gained from other methods is significantly lower than 93 percent, respectively.

## REFERENCES

1. Muthukrishnan, A.; Charles Rajesh Kumar, J.; Vinod Kumar, D.; Kanagaraj, M. Internet of image things-discrete wavelet transform and Gabor wavelet transform based image enhancement resolution technique for IoT satellite applications. *Cogn. Syst. Res.* 2019, 57, 46–53.
2. D. Vinod Kumar, A. Nagappan. "Performance Analysis of Security and Accuracy on Palmprint Based Biometric Authentication System," *International Journal of Innovative Research in Computer and Communication-Engineering*, Vol. 3, Issue 7, July 2015, pp 6697-6704.
3. Charles Rajesh Kumar.J , Vinod Kumar.D, Baskar.D, Mary Arunsi.B, Jenova.R, ,M.A.Majid." VLSI design and implementation of High-performance Binary-weighted convolutional artificial neural networks for embedded vision based Internet of Things (IoT)".16th International Learning & Technology Conference (L&T), Procedia Computer science (Elsevier), Jeddah,2018.
4. D. Vinod Kumar, A. Nagappan. "Study and comparison of various point based feature extraction methods in palmprint authentication system," *International Journal of Computational Engineering Research (IJCER)* , Vol. 2, Issue 8, December 2012, pp 82-89.
5. D. Vinod Kumar, A. Nagappan, Jyoti Malik "Phase Congruency Corner Detection as Biometric Feature," *IRACST - International Journal of Computer Science and Information Technology & Security (IJSITS)*, Vol. 2, Issue 2, February 2012, pp 179-185.





## Sathish et al.,

6. Kong A. W. K., Zhang D. and Lu G., "A study of identical twins' palmprints for personal verification", Pattern Recognition, Vol. 39, Issue 11, Pages 2149-2156, November 2006.
7. Jazayeri I., Fraser C.S., "Interest Operators in Close-Range Object Reconstruction", The International Archives of the Photogrammetry, Remote Sensing and Spatial Information Sciences. Vol. XXXVII. Part B5. Beijing, Pages 69-74, July 2008.
8. Cronk S., Fraser C. S. and Hanley H. B., "Automatic calibration of colour digital cameras", Photogrammetric Record, Vol 2, No 1, Pages 355-372, January 2006.
9. Rosten E. and Drummond T., "Machine learning for high-speed corner detection", European Conference on Computer Vision, Graz, Austria, Pages 430-443, Feb 2006.
10. Edward Rosten and Tom Drummond, "Fusing Points and Lines for High Performance Tracking", Proceedings of the Tenth IEEE International Conference on Computer Vision, Pages 1508-1515, 17-20, October 2005.
11. Alexandra Teynor and Hans Burkhardt, "Wavelet-based Salient Points with Scale Information for Classification", 978-1-4244-2175-6/08 IEEE Pages 34-42, June 2008.
12. Tian Q., Sebe N., Loupias E. and Huang T. S., "Image retrieval using wavelet-based salient points", Journal of Electronic Imaging, Vol.10 No 4, Pages 835-849, October 2001.
13. Linghua Li\* and Lili Zhang, "Corner Detection of Hand Gesture" TELKOMNIKA, Vol.10, No.8, Pages 2088 – 2094, December 2012.
14. Quang Huy Nguyen, "Fast and accurate GCPS selection scheme for SAR image registration based on an improved Trajkovic corner detector", Geoscience and Remote Sensing Symposium (IGARSS), IEEE International, Vancouver, BC, Pages 578-581, 24-29 July 2011.
15. Jazayeri I., Fraser C.S., "Interest Operators in Close-Range Object Reconstruction", The International Archives of the Photogrammetry, Remote Sensing and Spatial Information Sciences. Vol. XXXVII. Part B5. Beijing, Pages 69-74, July 2008.
16. Trajkovic M. and Hedley M., "Fast Corner Detection", Image and Vision Computing, Vol. 16(2), Pages 75-87, July 1998.
17. Baskar. D, Selvam. P, "Electrical Transmission Line Fault Detection and Classification using Convolution Neural Networks and Support Vector Machine," Test Engineering & Management, vol. 82, pp. 6803-6808, Jan./Feb. 2020.
18. Baskar. D, Selvam. P, "Machine Learning framework for Power System Fault Detection and Classification," International Journal of Scientific & Technology Research, vol. 9, no. 2, pp. 2002-2008, Feb. 2020.

Table 1: FAR, FRR and Accuracy table for SUSAN operator

Threshold	FAR	FRR	Accuracy
1.23	0.22	0.059	86.05
1.74	0.19	0.065	87.25
1.89	0.14	0.066	89.7
2.1	0.093	0.072	91.75
2.25	0.088	0.079	91.65
2.5	0.082	0.083	<b>91.75</b>
2.75	0.074	0.096	91.5
3	0.067	0.1	91.65
3.25	0.059	0.17	88.55
3.5	0.053	0.2	87.35
3.75	0.042	0.29	83.4
4	0.034	0.32	82.3
4.25	0.027	0.37	80.15
4.5	0.014	0.42	78.3
4.75	0.006	0.42	78.7





**Sathish et al.,**

**Table 2: FAR, FRR and Accuracy table for Wavelet operator**

Threshold	FAR	FRR	Accuracy
0.01	0.27	0.042	84.4
0.02	0.15	0.047	90.15
0.03	0.097	0.059	92.2
0.04	0.084	0.065	92.55
0.055	0.0702	0.071	<b>92.94</b>
0.06	0.067	0.078	92.75
0.075	0.062	0.088	92.5
0.08	0.056	0.094	92.5
0.09	0.05	0.099	92.55
0.1	0.046	0.17	89.2
0.25	0.041	0.22	86.95
0.55	0.038	0.28	84.1
0.85	0.027	0.32	82.65
1	0.011	0.33	82.95
1.25	0.0043	0.28	85.785

**Table 3: FAR, FRR and Accuracy table for Trajkovic and Hedley corner detector**

Threshold	FAR	FRR	Accuracy
1.3	0.324	0.052	81.2
1.7	0.27	0.058	83.6
2.3	0.19	0.066	87.2
2.65	0.12	0.071	90.45
3.5	0.095	0.079	91.3
3.6	0.082	0.084	<b>91.7</b>
4.25	0.087	0.093	91
4.85	0.072	0.097	91.55
4.9	0.066	0.12	90.7
5.35	0.057	0.17	88.65
5.99	0.044	0.19	88.3
6.26	0.036	0.211	87.65
6.75	0.024	0.232	87.2
7	0.013	0.281	85.3
7.25	0.0052	0.293	85.09

**Table 4: FAR, FRR and Accuracy table for Forstner Operator**

Threshold	FAR	FRR	Accuracy
0.05	0.072	0.017	95.55
0.08	0.068	0.022	95.5
0.1	0.062	0.025	95.65
0.13	0.059	0.029	95.6
0.16	0.054	0.032	95.7
0.17	0.049	0.037	95.7
0.18	0.042	0.04	<b>98.9</b>
0.19	0.041	0.047	95.6





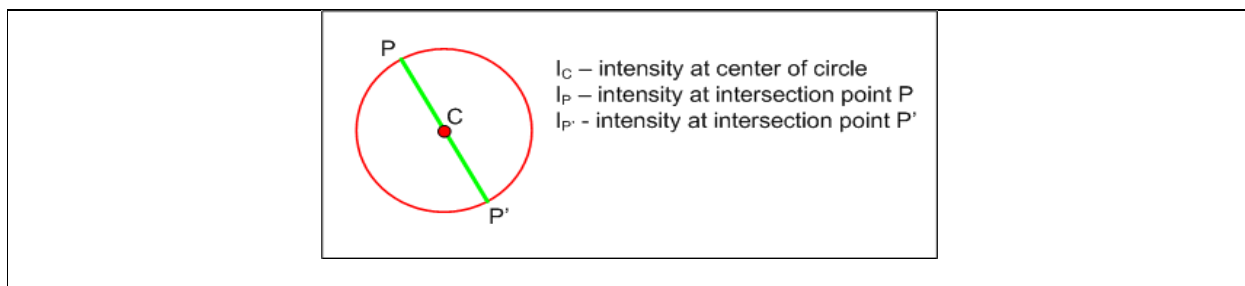


**Sathish et al.,**

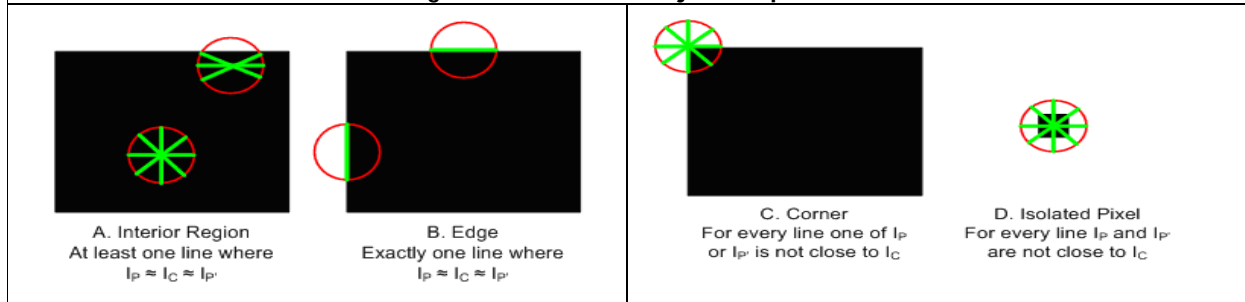
0.21	0.037	0.049	98.7
0.23	0.032	0.052	95.8
0.24	0.029	0.059	95.6
0.26	0.023	0.063	95.7
0.29	0.019	0.076	95.25
0.34	0.0101	0.083	98.345
0.4	0.004	0.094	95.1

**Table 5: Comparison of FAR, FRR and Accuracy of various Point Based Methods**

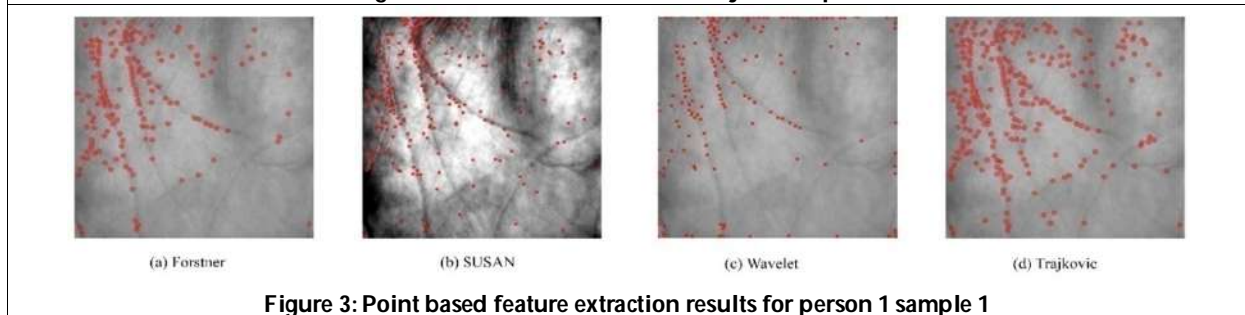
Method Name	Accuracy FAR = FRR	Accuracy for (FAR %)	Accuracy for (FAR %)
SUSAN	91.75	87.35 (5%)	89.7 (10%)
WAVELET	92.94	92.55 (5%)	92.2 (10%)
TRAJKOVIC	91.7	88.65 (5%)	91.3 (10%)
FORSTNER	98.9	98.35 (1%)	98.7 (2%)



**Figure 1: Notation for Trajkovic Operator**



**Figure 2: Different cases for the Trajkovic Operator**



**Figure 3: Point based feature extraction results for person 1 sample 1**





Sathish et al.,

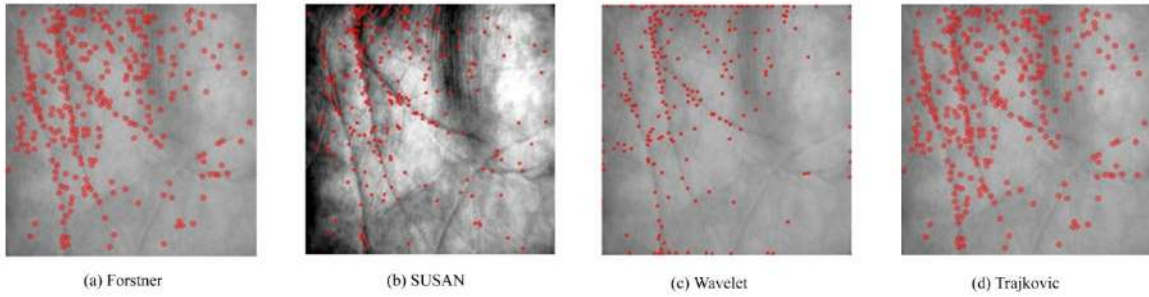


Figure 4: Point based feature extraction results for person 1 sample 2

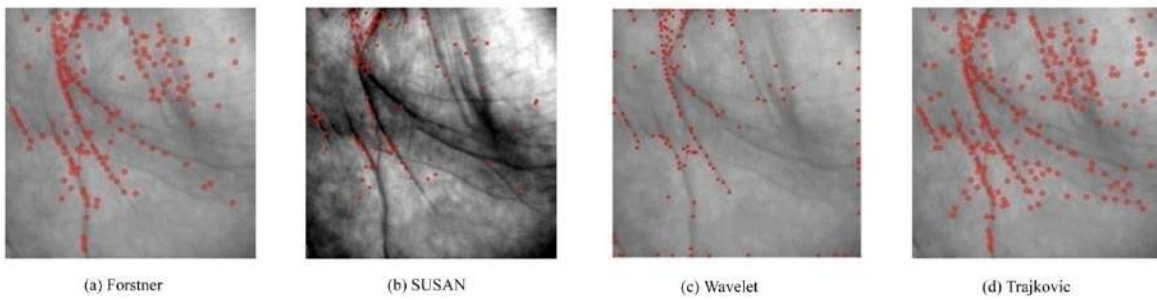


Figure 5: Point based feature extraction results for person 2 sample 1

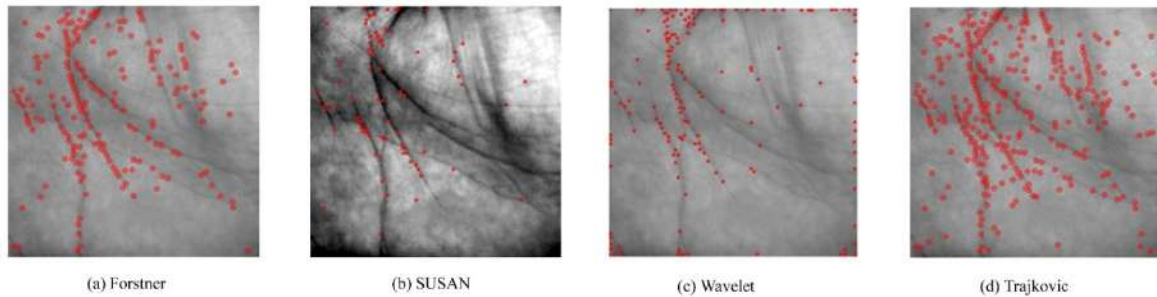


Figure 6: Point based feature extraction results for person 2 sample 2

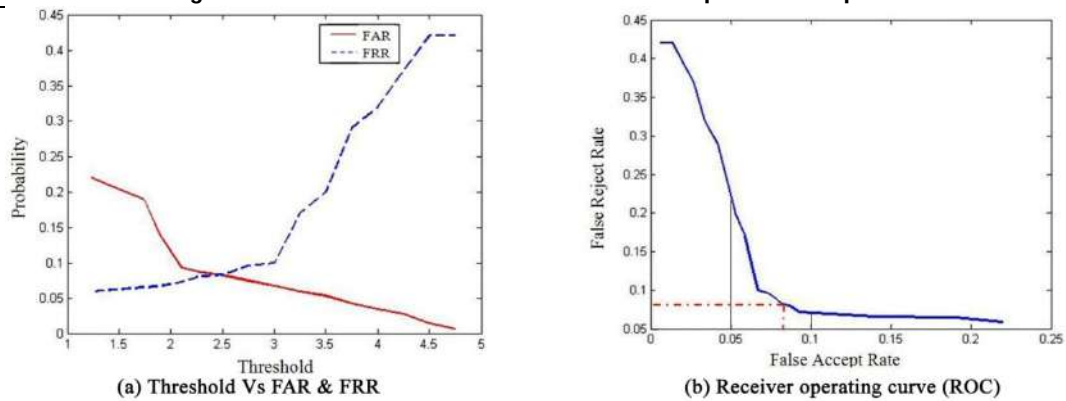


Figure 7: Accuracy plot for SUSAN operator





Sathish et al.,

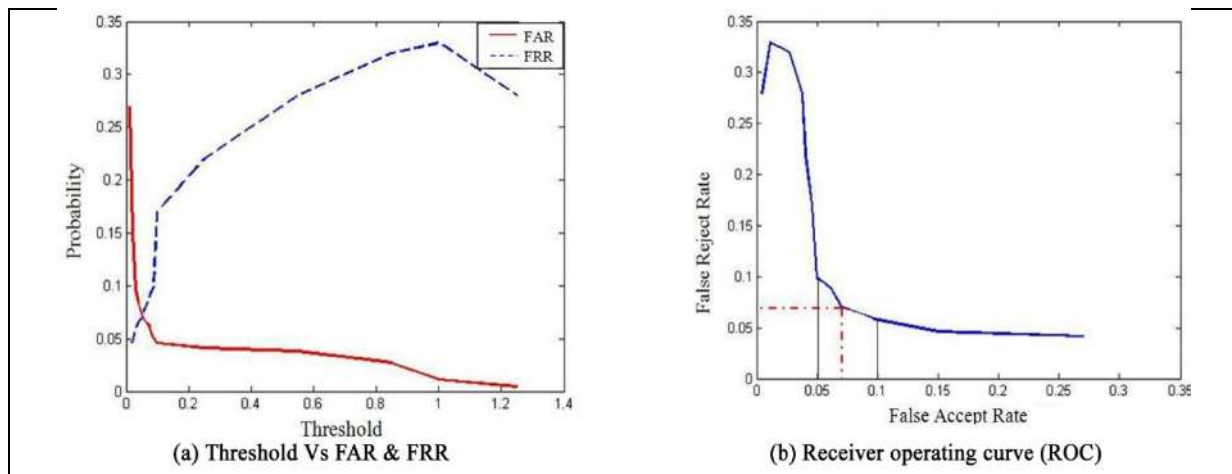


Figure 8: Accuracy plot for Wavelet operator

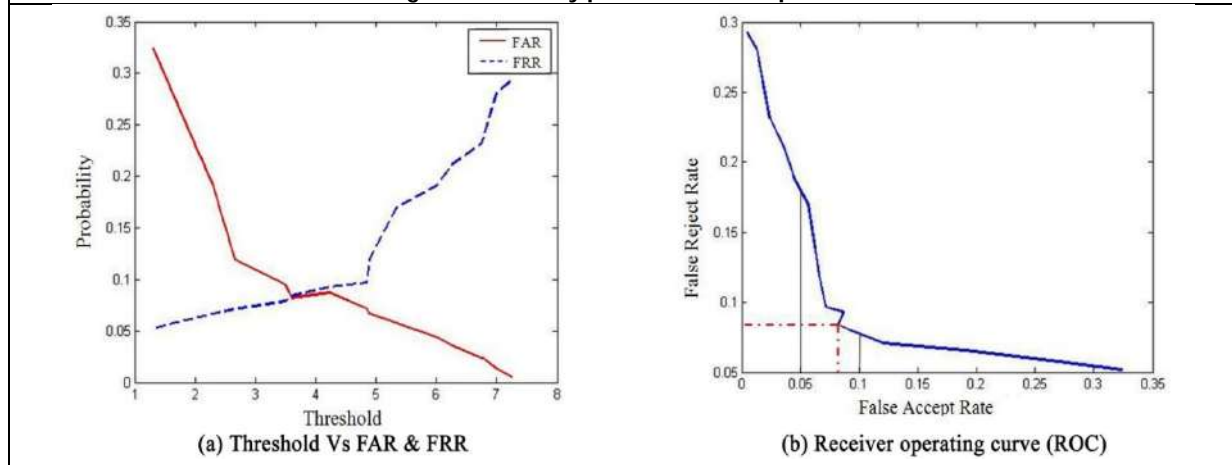


Figure 9: Accuracy plot for Trajkovic operator

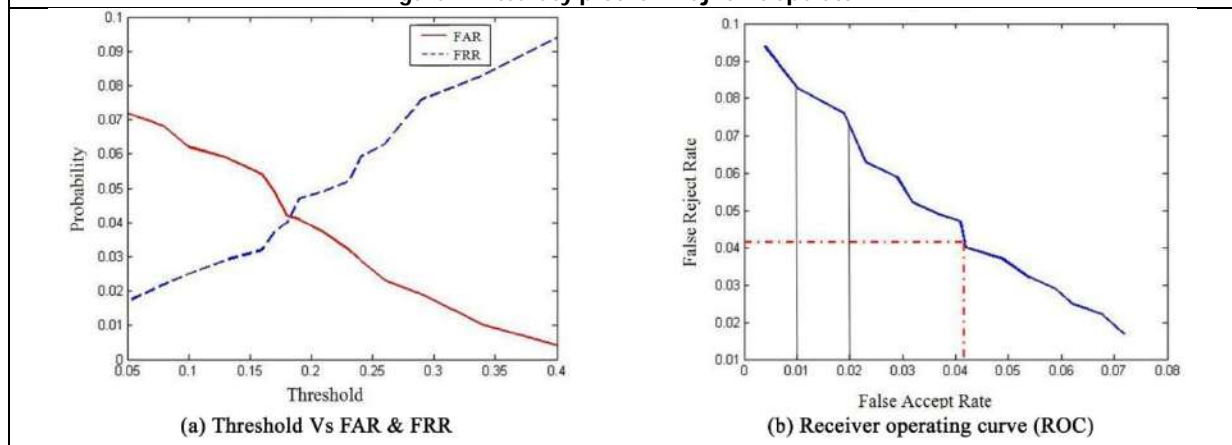


Figure 10: Accuracy plot for Forstner operator





## Insect Composition and Seasonal Variations of Physico-Chemical Parameters in Purle Tank of Shivamogga District, Karnataka

H.M.Ashashree<sup>1\*</sup> and B.R.Kiran<sup>2</sup>

<sup>1</sup>Assistant Professor, Department of Zoology, Sahyadri Science College, Shivamogga, Karnataka, India.

<sup>2</sup>Research & Teaching Assistant, DDE, Kuvempu University, Shankaraghatta, Karnataka, India.

Received: 23 Dec 2021

Revised: 05 Jan 2022

Accepted: 18 Jan 2022

### \*Address for Correspondence

**H.M.Ashashree**

Assistant Professor,  
Department of Zoology,  
Sahyadri Science College,  
Shivamogga, Karnataka, India.



This is an Open Access Journal / article distributed under the terms of the **Creative Commons Attribution License** (CC BY-NC-ND 3.0) which permits unrestricted use, distribution, and reproduction in any medium, provided the original work is properly cited. All rights reserved.

### ABSTRACT

Water pollution is a severe global problem due to different anthropogenic activities in the water bodies of India. The present study deals with the assessment of seasonal physico-chemical water quality and insect fauna of Purle Tank of Shivamogga during October 2017 to September 2018. A total of 12 species of aquatic insects belonging to 05 orders were recorded. Among orders, Hemiptera is dominant followed by Coleoptera and Diptera. Different seasons show fluctuations in various physico-chemical parameters. The water temperature ranged from 25.5 to 29°C. pH of this lake is slightly alkaline in nature. The values fluctuated between 38 (Post-monsoon) to 190 NTU ( Monsoon). Total dissolved solids were maximum in monsoon and minimum in Pre-Monsoon. The DO of water was low in Pre-monsoon (5.2mg/l) and high in Post-monsoon (8.4mg/l). BOD level ranged from 3.2 (Post-monsoon) to 4.8 ( Pre-monsoon) mg/l. CO<sub>2</sub> values of water has fluctuated between 16 mg/l (Post-monsoon) and 28 mg/l (Monsoon). The total hardness was lowest in Post-monsoon (68.4 mg/l) and highest in monsoon (84.8 mg/l). Calcium is considered the highest value of calcium recorded during monsoon season (38 mg/l) and lower values were recorded during Post-monsoon season (26 mg/l). Magnesium was lower in Post-monsoon ( 12 mg/l) and higher in Monsoon season with 23 mg/l. The fluctuation of Chloride of water varied between 36 mg/l (Monsoon) and 40 mg/l (Pre-monsoon). Sulphate content was found to be higher during Monsoon season (20.1 mg/l) and lower during Post-monsoon season (17.2 mg/l). Nitrate was maximum in monsoon season (19.4 mg/l) and minimum during Post-monsoon season (9.6 mg/l) and phosphate found high during Monsoon season and lower during Post-monsoon season .

**Keywords:** Insect fauna, Physico-chemical parameters, Purle tank, Seasonal variations, Shivamogga



**Ashashree and Kiran**

## INTRODUCTION

Water property are of primary significance to both everyday biosystem and human flip of activities (Medudhula Thirupathaiiah *et al.*, 2012). It is fundamental for farming, industry and human life. The solid aquatic environment is reliant upon the physico-synthetic and natural qualities (Venkatesharaju *et al.*, 2010). Water is one on the most significant and bountiful mixtures of the environment. All living life forms on the earth need water for their endurance and development (Yogitha and Ramachandra, 2018). Physico-chemical boundaries assume a significant part in the nature of a water body. The typical scopes of physico-chemical attributes demonstrate the great water quality (Swaminathan and Manonmani, 1997). The quality and quantity of lakes and tanks rely upon the environment, catchment area, types of rocks/soil and sources of info and results both natural and artificial (Gray, 1994).

The water nature of lakes and tanks can be corrupted due to microbiological and compound foreign substances. Lentic water bodies assume a vital part in keeping up with the biodiversity and over all biological equilibrium in nature. Ecological contamination is a cutting edge detestable influencing all environments (Mahapatra and Rangarajan, 1995). Spontaneous metropolitan improvement has presented colossal issues of ecological contamination. Because of this, water of regular bodies is getting dirtied at a disturbing rate (Shastri *et al.*, 2008). Because of anthropogenic exercises, fast modern development, homegrown and agrarian exercises of the locale, the water body is being contaminated, which is the situation with practically all significant water assortments of the country (Manjappa *et al.*, 2008). The appropriate equilibrium of physical, substance and natural properties of water in lakes, lakes and supplies is fundamental for Limnological examinations. Plenitude of specific component may recommend the kind of living being that might be found just as sign of environmentally troublesome biological system which can emphatically affect the populace for example high centralization of nitrate or phosphate is demonstrative of eutrophication (Patil Shilpa *et al.*, 2012; Sayeswara and Ashashree, 2018).

Globally, around 45,000 species of insects live in fresh water ecosystem (Balaram, 2005). Aquatic insect are involved in nutrient recycling and form an important element of natural food web. Some are them play a role in biological control of mosquitoes and many aquatic insects are used as a food for fishes and acts as pollution indicators. They are the most important bio- indicator of freshwater habitats such as lentic and lotic water bodies due to their different environmental disturbance tolerance levels (Arimoro and Ikomi, 2008; Mirgane Amol Prabhakar and Kumbhar Arvind Choodamani, 2018). The literature revealed that there is no scientific data is available with regard to seasonal physico-chemical traits and insect fauna of this tank. In the current investigation, an effort has been made to verify the fine and suitability of water for human utilization.

## MATERIALS AND METHODS

### Study Area

Purle tank is perennial water body as it receives the water from Tunga canal and waste water from Shivamogga areas. The total area of this tank is about 55 hectares but water spreads area is 43 hectares with an average depth of 6-7 feet. This tank water is used for human activities and also for fish culture. This tank is adjacent to Subbaiah medical college and surrounded by dense human population. The riparian vegetation consists of Arecanut, coconut (Figure 1).

### Collection of the Sample

Water samples of Purle Tank was collected during the period from October 2017 to September 2018. During the study period, a water sample measuring 2 liters was collected for the analysis of physico-chemical parameters in a clean plastic can between 9 AM to 10 AM once a month and analysed as per standard methods of APHA (2012) and Trivedy and Goel (1984). The sterilized plastic containers were used for sample water collection. One way ANOVA and Tukey's Multiple comparison tests are carried out for water quality parameters by using [www.aatbio.com](http://www.aatbio.com) and [www.astasa.com](http://www.astasa.com) software's. Individuals were identified up to genus or species level as could be possible and



**Ashashree and Kiran**

number of each type was noted. The qualitative analysis of macro invertebrates samples was made with the help of Edmondson (1959), Needham and Needham (1962), Pennak (1978) and Tonapi (1980).

**RESULTS AND DISCUSSION**

A total of 12 species of aquatic insects belonging to 05 orders were recorded. Among orders, Hemiptera has 05 species (41.67%) followed by Coleoptera - 03 species (25%), Diptera with 02 species (16.67%) . Trochoptera and Ephemeroptera each with 8.33% respectively (Table 1, Figure 3) The orders Hemiptera, Odonata, Coleoptera and Ephemeroptera are the bio-indicators of water quality and they act as biocontrol agents. Similar justification were reported by Majumder *et al.*, (2013) as they reported 31 species from fresh water lake of Tripura having 23 genera, 15 families and 4 orders and they opined that Hemiptera and Odonata were dominant orders. Water temperature is the most important physical parameter in case of Limnological studies, it very much essential to study as the growth and distribution of organisms is influenced by this factor (Abir, 2014). The WT values ranged from 25.5 to 29°C. The seasonal variability of water temperature has fluctuated between 25.5 °C (Post-monsoon) and 29 °C (Pre-monsoon). Due to the area of the tank, quick reaction to atmospheric temperature changes was noticed. Mishra et al ( 2008) and Bidisha and Gosh (2018) have obtained same results in their study. The pH of water body is very important in determination of water quality since it affects other chemical reactions such as solubility and metal toxicity (Fakayode, 2005). pH of this lake water is slightly basic and found within permissible limit as per the Bureau of Indian Standards. The minimum value was recorded in Post monsoon and maximum value recorded in Pre monsoon.

Turbidity measures suspended and inorganic matter in the water. The values fluctuated between 38 (Post-monsoon) to 190 NTU ( Monsoon).Total dissolved solids ranged in between 90 to 123mg/l. being maximum in monsoon and minimum in Pre-Monsoon season.. The higher TDS might be due to surface run-off. TDS analysis has great implications in the control of biological and physical water treatment process. Dissolved oxygen is an important gaseous factor that determines the quality of water and regulates the distribution of aquatic organisms. The seasonal variation of DO of water was low in Pre-monsoon (5.2mg/l) and high in Post-monsoon (8.4mg/l). The variations of DO depend on the primary productivity and respiration of fauna in the tank. Lower DO in summer may be due to higher decomposition of organic matter and limited flow of water in low holding environment due to high temperature (Rani *et al.*, 2004). In this study, BOD level ranged from 3.2 (Post-monsoon) to 4.8 ( Pre-monsoon) mg/l. BOD is the measure of degradable organic matter in water. BOD increases as the microbial activities are increased due to entry of sewage (Hynes, 1971). CO<sub>2</sub> values of water has fluctuated between 16 mg/l (Post-monsoon) and 28 mg/l (Monsoon). The total hardness was lowest in Post-monsoon (68.4 mg/l) and highest in monsoon (84.8 mg/l). Total hardness of water is not a pollution parameter but indicates water quality mainly in terms of calcium and magnesium contents.

Calcium in drinking water is received from geological source, industrial wastes, mining and agricultural wastes. Calcium salts are non-toxic except at very high doses (100 mg for 20 days).. Maximum permissible limit of calcium in drinking water is 100ppm as suggested by USPH and 200 mg/l by WHO as suggested by ICMR. The calcium level was highest during monsoon season with 38 mg/l and lowest values in Post-monsoon season with 26 mg/l. Magnesium is always be lower than calcium. Maximum permissible limit of magnesium in drinking water is 150 mg/l as prescribed by WHO. In Purle tank, magnesium was lower in Post-monsoon ( 12 mg/l) and higher in Monsoon with 23 mg/l respectively. Chloride in sewage manage the salinity of water and osmotic pressure on biotic organisms (Goel *et al.*, 2003). Seasonally the fluctuation of Chloride of water varied between 36 mg/l (Monsoon) and 40 mg/l (Pre-monsoon).Domestic waste discharge into tank water tends to increase sulphate concentration. In the present study, seasonal variation of sulphate found higher values during Monsoon season (20.1 mg/l) and lower levels recorded during Post-monsoon season (17.2 mg/l).

The main sources of nitrate in water may perhaps due to oxidation of organic nitrogenous substance and sewage. Nitrate is an oxidizing agent converts iron in the haemoglobin in animals. Seasonal variations are considered maximum values recorded during monsoon season (19.4 mg/l) and minimum during Post-monsoon season (9.6



**Ashashree and Kiran**

mg/l) Domestic waste, detergents and agricultural runoff are the main sources of phosphate. High concentration of  $\text{NO}_3$  and phosphate leads to eutrophication. Phosphate found to be peak during Monsoon season with 1.2 mg/l and lower in Post-monsoon season with 0.4 mg/l. Ashashree and Kiran (2021) have studied the physico-chemical parameters and biotic community of Hosahalli pond of Shivamogga district in Karnataka. In their study, 64 species of phytoplankton, 11 zooplankton, 07 hydrophytes, 04 aquatic insects/ beetles, 03 molluscs and 01 species each of annelid worm, rhizopoda and parasitic ciliates were recorded. They revealed that the Hosahalli pond was contaminated due to human conflict, entry of domestic waste water and surface runoff from the nearby area.

**One-way ANOVA for density of Insects in Purle tank**

Table 8 and 9 depicts One-way ANOVA for density of Insects. The p-value analogous to the F-statistic of one-way ANOVA is higher than 0.05, suggesting that the treatments are not significantly different for level of significance.

**CONCLUSION**

The study revealed that there were variations in certain physico-chemical properties of Purle Tank of Shivamogga district of Karnataka due to the surface run-off and human activities. The results were compared with standard values prescribed by the Bureau of Indian Standard and World Health Organization. Some of the physico-chemical characteristics were found above permissible limits. Therefore, the present investigation based on scientific methodology clearly shows that the Purle tank water can be used for human usage after proper treatment.

**REFERENCES**

1. Abir, S.2014. Seasonal variations in Physico-chemical characteristics of Rudrasagar wetland – A Ramsar Site, Tripura, North East, India. Research Journal of Chemical sciences, 4(1): 31-40.
2. APHA. 2012. American Public Health Association Standard Methods for examination of water and waste water specifications. Washington D.C., 6. 22<sup>nd</sup> edition.
3. Arimoro F.O. and R.B. Ikomi, 2008. Ecological integrity of upper Warri River, Niger Delta using aquatic insects as bioindicators. Ecological Indicators, 395, pp. 1-7.
4. Ashashree, H.M and Kiran,B.R.2021. Limnological study of Hosahalli Pond in Shivamogga district, Karnataka. International Journal of Entomology Research volume 6 (6):101-105.
5. Balaram P., (2005): Insect of tropical streams. Curr. Sci., 89: 914.
6. Bidisha Bhattacharya (Nee) Ghosh. 2018. Physico-chemical analysis of pond water in Purba Barddhaman, West Bengal, India. International Research Journal of Environmental Sciences, 7(2): 54-59.
7. BIS.1993. Specification of drinking water. Bureau of Indian Standards, New Delhi, 171-178
8. Dhruv, K., Singh, Sinha, A.K., Amitabh Baruah and Sharma, U.P.1994. Comparative diel variation in biotic factors of two zones of Kawar lake (Begusarai), Bihar, India. Geobios, 21: 260-265.
9. Edmondson WT (1959).Ward and Whipple's Freshwater Biology, 2<sup>nd</sup> Ed. John Wiley & Sons Inc., New York. 1248 pp.
10. Fakayode, S. 2005. Impact assessment of Industrial effluents on water quality of the receiving Alaro river in Ibadan, Nigeria, Ajeam-Ragee, 10:1-13.
11. Goel, P.K., Gopal, B and Trivedy, R.K. 1980. Impact of sewage on freshwater ecosystem. International Journal of Ecology and Environmental Science. 6: 97-116.
12. Gray, N.F. 1994. Drinking water quality problems and solutions, Chichester, UK, John Wiley & Sons.
13. Hynes, H.B.N.1971. The Biology of Polluted water. University Press, Canada.
14. Mahapatra, B.C. and Rangarajan. 1995. Effects of some heavy metals on certain tissues of *Liza parsia* (Ham-Buch) in different environments. CMFRI Publications, 61:6-12.
15. Majumder J., Rajib K. Das, Prasanta Majumder, D.Ghosh and B.K. Agarwala, 2013. Aquatic insect fauna and diversity in urban fresh water Lakes of Tripura, Northeast India. Middle-East journal of Scientific Research. 13 (1): pp. 25-32.





### Ashashree and Kiran

16. Manjappa, S., Suresh, B., Aravinda, H.B., Puttaiah, E.T. and Thirumala, S.2008.Studies on environmental status of Tungabhadra river near Harihara, Karnataka, India. Journal of Aquatic Biology, 23(2): 67-72.
17. Medudhula Thirupathaiiah, Ch. Samantha and Chintha Sammaiah. 2012. Analysis of water quality using physico-chemical parameters in lower Manair reservoir of Karimnagar district, Andhra Pradesh. International Journal of Environmental Sciences, 3(1): 172-180.
18. Mirgane Amol Prabhakar and Kumbhar Arvind Choodamani.2018. Aquatic insect diversity of fresh water body at Katphal lake, tal- Sangola, dist Solapur (M.S.) India. Paripex - indian journal of research Volume-7(5) :26-27.
19. Mishra, R.R., Rath, B. and Thotai, H. 2008. Water quality assessment of aquaculture ponds located in Bhitarkanika Mangroove Ecosystem, Odissa, India. Turkish Journal of Fisheries and Aquatic Science, 8: 71-77.
20. Pennak RW(1978).Freshwater invertebrates of United States,2ndEd.Johan Wiley and Sons Inc.,New York.803 pp.
21. Patil Shilpa, G., Chonde Sonal, G., Jadhav Asawari, S. and Raut Prakash, D. 2012. Impact of physico-chemical characteristics of Shivaji University lakes on phytoplankton communities , Kolhapur, India. Research Journal of Recent Sciences, 1(2): 56-60.
22. Rani, R., Gupta, B.K. and Srivastava, K.B.L 2004. Studies on water quality assessment in Satna city (M.P.): Seasonal parametric variations, Nature Environment and Pollution Technology, 3(4): 563-565.
23. Sayeswara H.A and Ashashree,H.M. 2018 .Studies on water quality evaluation of Nidige tank (Chunchadri water sports), Shivamogga, Karnataka, India. International Journal of Engineering Science Invention vol. 07(10): 29-38.
24. Shastri, Gayatri Neelam, Singh, N.K. and Uttar Tewari. 2008. Physico-chemical analysis of Chingrajapura pond water of Bilaspur, Chhattisgarh (India). Journal of Aquatic Biology, 23(2): 87-90.
25. Swaminathan, K and Manonmani, K. 1997. Studies on toxicity of viscose rayon factory effluents. Journal of Environmental Biology, 18(1): 73-78.
26. Trivedy, R.K. and Goel, P.K. 1984. Chemical and biological methods for water pollution studies. Environmental publication, Karad, India.
27. Venkatesharaju, K., Ravikumar, P., Somashekar, R.K. and Prakash, K.L.2010. Physico-chemical and biological Investigation on the river Cauvery of Kollegal stretch in Karnataka. Journal of Science Engineering and Technology, 6(1): 50-59.
28. Yogetha, S.B. and Ramachandra Mohan, R. 2018. A Study on physico-chemical parameters of Thally lake of Tamil Nadu, India. Global Journal for Research Analysis, 7(2): 497-498.

**Table 1: Occurrence (Org./m<sup>2</sup>) of Insect fauna of Purle tank**

	Summer	Rainy	Winter
<b>Diptera</b>			
<i>Chironomous larvae</i>	32	20	45
<i>Culex larvae</i>	8	10	15
<b>Hemiptera</b>			
<i>Lethocerus sp.</i>	4	3	5
<i>Notonecta sp.</i>	9	7	17
<i>Hesperocorixa sp.</i>	8	12	6
<i>Gerris sp.</i>	7	10	8
<i>Hydrophilus sp.</i>	6	8	3
<b>Coleoptera</b>			
<i>Dysticus sp.</i>	3	5	4
<i>Halipus</i>	9	6	7
<i>Limnophilus larva</i>	1	1	2
<b>Trochoptera</b>			
<i>Caddis fly larva</i>	1	1	1
<b>Ephemeroptera</b>			
<i>Beetles</i>	2	1	1







**Ashashree and Kiran**

### One way ANOVA and Tukey's Multiple Comparison for Water quality parameters

**Table 2: ANOVA data**

Parameter	Value
F (2, 39)	0.6766
p-value	0.5142

**Table 3: Tukey's Multiple Comparison Test**

	Difference	Lower	Upper	p-value Adjusted
Post-monsoon- Pre-monsoon	4.6143	-31.4258	40.6543	0.9479
Post-monsoon-Monsoon	16.6643	-19.3758	52.7043	0.5038
Pre-monsoon-Monsoon	12.05	-23.99	48.09	0.6963

**Table 4: Pairwise T-Test (Pooled SD, BH Adjusted) Comparison**

	Post-monsoon	Pre-monsoon
Pre-monsoon	0.7568	-
Monsoon	0.6304	0.6304

**Table 5: Welch's One-way ANOVA**

Parameter	Value
F	0.5112
DF (Numerator)	2
DF (Denominator)	24.8128
p-value	0.6059

**Table 6: Shapiro-Wilk Normality Test**

Parameter	Value
W	0.7942
p-value	0.0000033453

**Table 7: Kruskal-Wallis Rank Sum Test**

Parameter	Value
Kruskal-Wallis chi-squared	0.5877
DF	2
p-value	0.7454





**Ashashree and Kiran**

**Table 8: Descriptive statistics of independent treatments**

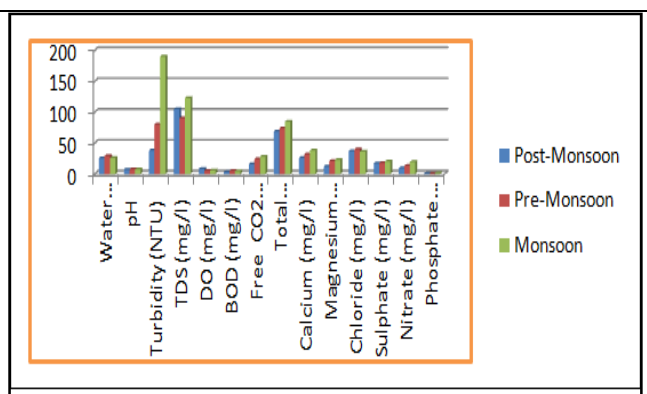
Treatment →	Summer	Rainy	Winter	Seasons pooled	Pooled Total
Sum	90.0000	84.0000	114.0000	175.0000	463.0000
Mean	7.5000	7.0000	9.5000	14.5833	9.6458
Sum of squares	1,430.0000	930.0000	2,744.0000	4,307.0000	9,411.0000
Sample variance	68.6364	31.0909	151.0000	159.5379	105.2123
Sample std. dev.	8.2847	5.5759	12.2882	12.6308	10.2573
Std. dev. of mean	2.3916	1.6096	3.5473	3.6462	1.4805

**Table 9: One-way ANOVA of independent treatments**

Source	Sum of squares	Degrees of freedom	Mean square	F statistic	p-value
Treatment	432.0625	3	144.0208	1.4042	0.2542
Error	4,512.9167	44	102.5663		
Total	4,944.9792	47			



**Figure 1: View of Purle tank adjacent to Subbaiah Institute of medical Sciences**



**Figure 2: Seasonal variation of physico-chemical parameters in Purle tank**





Ashashree and Kiran

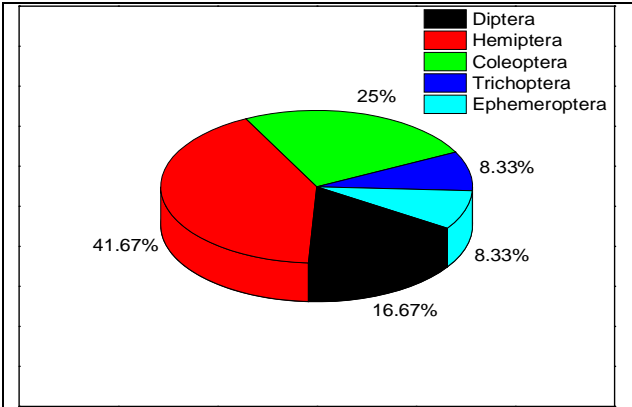


Figure 3: Percentage occurrence of insect orders in Purle tank

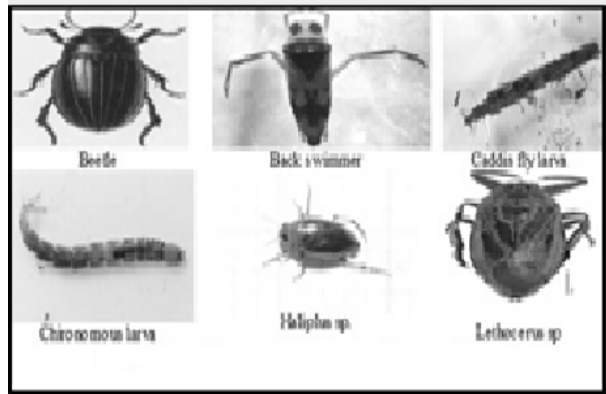


Figure 4: Insect fauna of Purle tank





## Impact of Financial Leverage on Financial Performance and Shareholders' Return of Select Companies in Indian Chemical Industry

A.Rifana<sup>1\*</sup> and D.Geetha<sup>2</sup>

<sup>1</sup>Research Scholar, Department of Commerce, Avinashilingam Institute for Home Science and Higher Education for Women, Coimbatore, Tamil Nadu, India.

<sup>2</sup>Professor and Head, Department of Commerce, Avinashilingam Institute for Home Science and Higher Education for Women, Coimbatore, Tamil Nadu, India.

Received: 25 Nov 2021

Revised: 29 Dec 2021

Accepted: 12 Jan 2022

### \*Address for Correspondence

**A.Rifana**

Research Scholar,

Department of Commerce,

Avinashilingam Institute for Home Science and Higher Education for Women,

Coimbatore, Tamil Nadu, India.

Email: arifana1203@gmail.com



This is an Open Access Journal / article distributed under the terms of the **Creative Commons Attribution License** (CC BY-NC-ND 3.0) which permits unrestricted use, distribution, and reproduction in any medium, provided the original work is properly cited. All rights reserved.

### ABSTRACT

Financial decision is requisite for any organization. The primary objective of financial management is to enhance the financial decision and capital structure decision. During the capital structure decision-making, one of the important issue is the determination of firm's proper mix of debt and equity. One of the globally accepted issue is financial leverage. If it increases, it enhances the firm's performance and maximize the shareholders benefit and vice versa. Both the advantages and disadvantages are there in employing financial leverage. So the present study aims "To find out the impact of financial leverage on financial performance and shareholders' return". For this purpose 15 Indian Chemical Companies based on Average Market Capitalization(AMFI) and also listed in Bombay Stock Exchange (BSE) who declared Dividend continuously for 15 years were taken. The Descriptive Statistics, Panel Data Regression Analysis (Hausman Test, Breusch-Pagan LM Test) and Structural Equation Model (SEM) were applied and analysed for 15 years period from 2007 to 2021. "Debt Ratio and Debt Equity Ratio were taken as independent variables to measure the financial leverage. The Dependent variables to measure financial performance are Current Ratio-Liquidity, Interest Coverage Ratio-Solvency, Total Asset Turnover Ratio-Efficiency and Net Profit Ratio-Profitability and Shareholders' return are Return on Equity and Earnings per Share". The findings were conferred in the study.

**Keywords:** Financial leverage, Financial Performance, Shareholders' return, SEM, Panel Data Regression:



**Rifana and Geetha**

## INTRODUCTION

A successful organization definitely will have the effective and controllable financial management. One of the most cardinal part in financial management is the financial decision. In Corporate finance, the function of financial decision is to determine the best capital structure or financing mix to maximize the owner's wealth and value of the firm (DestaZelalem, 2020). The relationship between debt and equity is termed as capital structure. The usage of debt fund along with owner's equity is known as gearing or trading on equity or financial leverage (IM Pandey, 2015). The Association amid borrowed funds and owner's funds in the firm's capital structure is termed as financial leverage (UtkarshGoel, 2015). The Financial Leverage reveals the extent of assets financed by the firms debt fund (Adenugba et al. 2016). One of the tools required by a company to enhance performance is financial leverage (Kenn-Ndubuisi, 2019). Moreover the financial leverage primary purpose is to maximize the shareholders' return under optimistic economic conditions (Dr.MohdTaqi et al 2020). The primary goal of using financial leverage by the firm is to increase the shareholders' return (IM Pandey, 2015). Financial leverage has two main advantage, from the shareholders point of view, it increases their value, on the other hand, from the company view point, tends to get tax advantage (Barakat, 2014). It is indeed important to maintain the long term financial sources which paves way to maximize the shareholders benefit (Enekwe et al. 2014). If the firm uses high leverage in its capital structure, then the interest (service for debt) increases which is detrimental. Financial leverage is also the indicator of risk (Dr. Sanjay, 2018). It is necessary to examine the leverage effects as it is one of the significant financial structure decision component (Banafa, A. S et al, 2015). "Relationship between financial leverage and financial performance" had a little impact found by (K. Rajamani, 2021), negative relationship by (Dr.Josheena Jose, 2017) and positive impact found by (Mohammad Ali, 2014). "Relationship between financial leverage and shareholders' return" had a significant relation found by (M. Kannadhasan, 2016), negative relation found by (Nirujah,R et al, 2014). Furthermore, evidences are available to prove that the relationship between them is not true universally, hence it depends upon situation (Simerly and Li, 2000).

### Statement of the Problem

Financial Leverage is the world-wide issue. "It is a Double-Edged Sword". It may increase or shrink shareholders return. In India, the schemes like "Make In India" were implemented to attract Foreign Direct Investment. According to the report released by Department for Promotion of Industry and Internal Trade ([www.ibef.org](http://www.ibef.org)), Chemical Industry ranks 2<sup>nd</sup> position in FDI Equity inflow (18.5 Billion). There should be a proper mix of debt and equity (Financial leverage) to attain "Optimal Capital Structure". Hence the study of "Impact of Financial Leverage on Financial Performance and Shareholders' Return of Select Companies in Indian Chemical Industry" will help to find out the optimum proportion of debt and equity and also help to take wise capital structure decision. So that it can attract large number of shareholders investment which results in enhancement of the financial performance of Select Companies in Indian Chemical Industry. By this, FDI in this Industry will started to increase and there is a chance to reach 1<sup>st</sup> position in the FDI inflow Category.

### Research Gap

There are countless studies relating "Impact of Financial Leverage on Financial Performance" and also "Financial Leverage impact on Shareholders' Return". But the study relating "Financial Leverage Impact on Financial performance and Shareholders' Return" together are very few especially in Indian Chemical Industry. Even those studies used the measures for Financial Performance are "Return on Equity (ROE), Return on Asset (ROA) and Return on Capital Employed (ROCE)" respectively. For assessing financial status/performance, Ratio is used as a benchmark in financial analysis (IM Pandey, 2015). So to fulfil that research gap, present study is undertaken.

### Objectives

- To find out the impact of Financial Leverage on Financial Performance of Select Companies in Indian Chemical Industry.





### Rifana and Geetha

- To know the impact of Financial Leverage on Shareholders' Return of Select Companies in Indian Chemical Industry.

#### Hypothesis

H<sub>01</sub>: There is no impact of financial leverage on financial performance.

H<sub>02</sub>: There is no impact of financial leverage on shareholders' return.

#### Breusch-Pagan LM Test

H<sub>03</sub>: If P>0.05, there is no significant so Pooled OLS Regression is accepted

H<sub>3</sub>: If P<0.05, there is a significant so Random Effect Model/ Fixed Effect Model is accepted.

#### Hausman Test

H<sub>04</sub>: If P>0.05, there is no significant so Random Effect Model is accepted

H<sub>4</sub>: If P<0.05, there is a significant so Fixed Effect Model is accepted

## METHODOLOGY

#### Sample

A sample of 15 Indian Chemical Companies were selected for the research on the basis of the following criteria,

- Bombay Stock Exchange (BSE) listed companies.
- Top 15 companies based on Average Market Capitalization(AMFI).
- Dividend declared continuously for 15 years.

#### Nature

The Research include data which are in secondary nature. The Required data is composed from annual report of the respective concern/companies, websites like NSE, AMFI, Money control and Capitaline. Various other journals, internet, websites were also used to collect other related information regarding the research.

#### Period

From 2006-07 to 2020-21, 15 year period is taken for analysis.

#### Tools

The statistical tools like Descriptive statistics- Minimum range, Variance, Kurtosis, Mean value, Standard Deviation, Maximum range and Skewness were performed to know scatterings and the nature and of the selected variables. Panel Data Regression Analysis (Hausman Test, Breusch-Pagan LM Test) was applied to know the impact of respective research objectives. Structural Equation Model (SEM) was performed to know the overall relationship of the selected variables in the study. The software used are SPSS, E-views and AMOS.

**Model Framed:** To test the hypothesis, following models were framed for the study,

$$Y_{it} = \alpha + \beta X_{it} + \varepsilon_{it}$$

Where, Y represents Dependent Variable, the indices i and t refers to individuals and time,  $\alpha$  and  $\beta$  are coefficients, X means to Independent Variable and finally  $\varepsilon$  is error term.

## ANALYSIS AND INTERPRETATION

#### Descriptive Statistics

Table-4 reveals the nature and behaviour of the selected variables in the study. Total number of observation is 225 where 15 companies were analysed for 15 year period. The average of DER is 49% (0.49) which means that the selected Chemical companies use nearly half percentage of borrowed funds along with equity in its capital structure.





### Rifana and Geetha

And 19% (0.19) of debt in its assets. Minimum and maximum values for all the variables were displayed. The selected chemical companies pay off their interest at 56% (56.36) and the maximum value of Interest Coverage Ratio (ICR) is 2348.56. By this it is understood that the operating efficiency is good and this industry can pay off their debts correctly. All the selected variable averages are higher than their standard deviation, it reveals that they are closely related except ICR, NPR and EPS. Variances of all the independent and dependent variable are less than its respective Averages and so there is a consistency in dealing with Current obligations, Acquiring debt, Coverage of interest, Earnings per share, Asset turnover, Profit earnings and return for equities. The variables heterogeneous, scatterness and dispersal are suggested by kurtosis and skewness. Except TATR all the other variables are positively skewed. CR, ICR, NPR and EPS are greater than one so they are highly skewed. Again in kurtosis, the values of CR, ICR, NPR, ROE and EPS are greater than one, which means that they are close to their mean and highly peaked. Hence they are called Leptokurtic. DR and DER are negative kurtosis so they are called Platykurtic.

#### Panel Data Regression Analysis

##### Model 1

In table-5, Breusch-Pagan Lagrange Multiplier Tests shows significant [46.79487(0.0000)] only in Cross- section. "Hence  $H_{03}$  null hypothesis is rejected and alternative hypothesis, If  $P < 0.05$ , there is a significant so Random Effect Model/ Fixed Effect Model is accepted". From Hausman Test, it is understood that the p value is less than 0.05 (0.0420), again "Null hypothesis  $H_{04}$  is rejected and alternative hypothesis, If  $P < 0.05$ , there is a significant so Fixed Effect Model is accepted". In table-6, DR (-5.799060) and DER (-1.001034) is negatively significant to CR at 1% and 10% significant level. R-square value is 0.354340 which means that 35% of variation in CR is made by DR and DER. F-statistic value (7.134444) with the probability of (0.000000) shows fitness of the model at 1% significant level. "Hence  $H_{01}$  null hypothesis is rejected and alternative hypothesis, There is an impact of financial leverage on financial performance is accepted".

CR = 2.456568 - 5.799060DR - 1.001034DER

##### Model 2

Table-7 reveals that the p values are greater than 0.05 in Breusch-Pagan Statistic (0.6852 and 0.7044) which means that they are insignificant. Thus POLS Regression model is appropriate so  $H_{03}$  null hypothesis "If  $P > 0.05$ , there is no significant so Pooled OLS Regression is accepted" and rejected the alternative hypothesis  $H_3$ . From table-8, it is understood that DR (-435.5073) and DER (-38.42441) probability values are less than 0.05 and 0.10 which means significant to ICR. Financial leverage make only 15% variations in ICR as its R value (0.156112). Remaining 85% variations are made by other factors. The model fits the data well as its F-statistic value (6.598696) with the p value (0.001645) is significant at 1% significant level. "Hence  $H_{01}$  null hypothesis is rejected and alternative hypothesis, There is an impact of financial leverage on financial performance is accepted".

ICR = 121.0496 - 435.5073DR - 38.42441DER

##### Model 3

Table-9 shows that the Breusch-Pagan Statistic P- value (517.0423) is significant only in cross section. "Hence  $H_{03}$  null hypothesis is rejected and alternative hypothesis, If  $P < 0.05$ , there is a significant so Random Effect Model/ Fixed Effect Model is accepted" i.e. One way Random Effect is appropriate than POLS. From Hausman test, it is confirmed that "Null hypothesis  $H_{04}$  is rejected and alternative hypothesis, If  $P < 0.05$ , there is a significant so Fixed Effect Model is accepted". Since p value (0.0487) is less than 0.05. In Table-10, Financial leverage (-1.034341, -0.330834) is significant to TATR at 1% significant level. "Hence  $H_{01}$  null hypothesis is rejected and alternative hypothesis, There is an impact of financial leverage on financial performance is accepted". R-square value is (0.654891) i.e. 65% of variations on TATR is made by DR and DER. At 1% significant level, F-statistic (24.66926) with p value (0.000000) portrays that the data fits the model well.

TATR = 0.990552 - 1.034341DR - 0.330834DER



**Rifana and Geetha****Model 4**

Table- 11 display the Hausman Test and Breusch-Pagan test, 0.0018 is the p value for cross-section i.e.  $0.0018 < 0.05$ . "Hence  $H_{03}$  null hypothesis is rejected and alternative hypothesis, If  $P < 0.05$ , there is a significant so Random Effect Model/ Fixed Effect Model is accepted" and performed. By the Hausman Test result (prob. =  $0.0243 < 0.05$ ), it is concluded that "Null hypothesis  $H_{04}$  is rejected and alternative hypothesis, If  $P < 0.05$ , there is a significant so Fixed Effect Model is accepted". Table-12 result shows that DR (0.0039) and DER (0.0460) is significant to NPR at 1% and 5% significant level respectively. Variations in NPR by DR and DER is 22% since R-squared value is 0.226311. The performed model fits the selected data well as F- statistic is 3.802616 with p value of 0.000003 at 1% significant level. "Hence  $H_{01}$  null hypothesis is rejected and alternative hypothesis, There is an impact of financial leverage on financial performance is accepted".

$NPR = 0.198631 - 0.785605DR - 0.126015DER$

**Model 5**

Table-13 portrays that the Breusch-Pagan test p value is  $0.0000 < 0.05$ . "Hence  $H_{03}$  null hypothesis is rejected and alternative hypothesis, If  $P < 0.05$ , there is a significant so Random Effect Model/ Fixed Effect Model is accepted". Hausman test result shows p value (0.6765) greater than 0.05. Alternative hypothesis  $H_4$  is rejected and Null hypothesis " $H_{04}$ : If  $P > 0.05$ , there is no significant so Random Effect Model is accepted". From table-14, it is understood that DR (-0.144155) and DER (-0.085571) is negatively significant to ROE which means that 1% increase in debt will decrease the ROE. R-Square value is 0.148235 which means that it makes 14% variation in ROE. F- Statistic is 5.625402 with p value (0.004138) indicates the model fit. "Hence  $H_{01}$  null hypothesis is rejected and alternative hypothesis, There is an impact of financial leverage on shareholders' return is accepted".

$ROE = 0.198577 - 0.144155DR - 0.085571DER$

**Model 6**

In Table-15, p value ( $0.0000 < 0.05$ ) of cross-section is significant. "Hence  $H_{03}$  null hypothesis is rejected and alternative hypothesis, If  $P < 0.05$ , there is a significant so Random Effect Model/ Fixed Effect Model is accepted" through the Breusch-Pagan LM test. Hausman test result shows that "Alternative hypothesis  $H_4$  is rejected and Null hypothesis, If  $P > 0.05$ , there is no significant so Random Effect Model is accepted" as its p value is  $0.2293 > 0.05$ . Table-16 reveals DR and DER is negatively significant to EPS at 5% and 10% significant level. "Hence  $H_{01}$  null hypothesis is rejected and alternative hypothesis, There is an impact of financial leverage on shareholders' return is accepted". 15% of variation made by financial leverage on ROE because its R-square value is 0.158744. The model fits the data well as the F- statistic 20.94550 with the p value of 0.000000 holds at 1% significant level.

$EPS = 49.74334 - 111.8062DR - 0.170404DER$

**Structural Equation Model**

Table-17 exhibits the model fit measurement indices and goodness of the Selected variables. The Chi-square value of the model is 33.463, it is significant at 1% significance level, (Degree of freedom= 15; P value= .004). The relative chi-square value is 2.231 which is the division of Chi-square Mean and Degree of freedom (CMIN/ DF). RMSEA (.074), CFI (.979), GFI (.964), NFI (.963), AGFI (.913) and TLI (.960) are also fulfils the recommended values mentioned in the above table. Therefore the model has good fit. Table-18 displays the overall model regression weight. At 1% level of significance, all the variables estimated values are found to be significant (P value=.000, .003). Financial leverage of selected chemical companies are significantly influencing the financial performance (1.000) and Shareholders Return (-.137) at one percent level. Debt Ratio (1.000) and Debt Equity Ratio (2.890) significantly influences financial leverage at one percent level. Financial performance of selected chemical companies are influenced by Current Ratio (1.000), Interest Coverage Ratio (-154.146), Total Asset Turnover Ratio (-.351) and Net Profit Ratio (-.279) at 1% significant level. Return on Equity (1.000) and Earnings per Share (456.577) at 1% significant level influences the Shareholders Return. The result of the model testing reveals that "There is an association of financial leverage with financial performance and shareholders' return" of Selected Indian Chemical companies.





**Rifana and Geetha**

## FINDINGS AND SUGGESTIONS

In Chemical Industry, financial leverage is significantly impact its financial performance. From the analysis it is found that there present negative impact of DR and DER on CR (Liquidity), ICR (Solvency), TATR (Efficiency) and NPR (Profitability). Liquidity and solvency are affected negatively by increased debt as it makes challenge to tackle the increasing working capital requirements. Increasing debt decreases efficiency and profitability due to the incurrence of increased financial cost. The Selected Chemical Companies' quantum of borrowed capital used will decrease the financial performance in this particular Industry. One percent increase in financial leverage decrease the financial performance at the same level. Similarly DR and DER negatively affect shareholders' return (ROE and EPS) of Selected Indian Chemical companies. From this it is understood that any amount of changes in the debt will negatively affect the shareholder's return. Negative impact of financial leverage shows that the proportion of debt borrowing need to be changed or revised for this industry. Structural Equation Model (SEM) reveals that there present an overall relationship of the selected variables in this study which supports the theory. Borrowers High interest imposed on the borrowing fund may be one of the reason for financial leverage negative relationship with financial performance and shareholders' return in the Chemical Industry. Success and longevity of any organization is critical on the basis of financial leverage, so it has to be carefully dealt and management should take wise decision. Debt and equity pertinent proportion should be carried out to enhance financial performance as well as to increase its shareholders' return. Debt in Chemical companies shows negative relationship, implementation of the appropriate quantum of debt along with equity will help to increase its earnings, profit share to equity holders and overall financial performance. Better management of inventory, increasing sales etc., will also help to increase the turnover from assets which will pave way for the good financial success inspite of its borrowing funds. Interest Coverage Ratio is considered as one of the dominant aspect in measuring the company stability and solvency. Moreover short term financial health is assessed well by ICR. So the Chemical industry is advised to opt for low interest bearing fund. By this it can pay only small amount of interest from its profit and retain more for shareholder's benefit.

## CONCLUSION

The Research picturised the sensitivity of relationship between ("financial leverage- financial performance") and ("financial leverage- shareholders' return") of selected Indian Chemical Companies. The Panel Data Regression analysis shows that there is a relationship between them. This research will help manager to check and practice fair mixture (debt & equity) and helpful in increasing overall performance and provide good returns to their shareholder. It moreover brings interest and act as a source of knowledge among academicians to undertake further research in this Chemical Industry by extending the number of companies and years. This research will be largely helpful in financing decision of companies in developing countries like India and also act as a base for development. In most of the cases, compared to low leveraged company, the high leveraged company have negative relationship and see volatility changes. Employment of debt increases in capital structure, then there present strong and increased negative relationship and impacts on the performance and shareholders benefit. So the Indian Chemical Industry is suggested to reduce the debt to maximize the overall performance. This Study on "Impact of Financial Leverage on Financial Performance and Shareholders' Return of Select Companies in Indian Chemical Industry" helps to improve Financial Performance and Shareholders' Return of select Indian Chemical companies, Chemical Industry. It significantly contributes to the Economic Development of India.

## REFERENCES

1. DestaZelalem. The Impact of Financial Leverage on the Performance of Commercial Banks: Evidence from Selected Commercial Banks in Ethiopia. International Journal of Accounting, Finance and Risk Management. 5(1). 2020. pp.62-68.
2. Goel, U., Chadha, S. and Sharma, A. K. Operating liquidity and financial leverage: Evidences from Indian Machinery Industry. Procedia - Social and Behavioral Sciences 189. 2015. pp.344 – 350.





### Rifana and Geetha

3. Adenugba, A. A., Ige, A. A. and Kesinro, O. R. Financial Leverage and Firms' Value: A Study of Selected Firms in Nigeria. *European Journal of Research and Reflection in Management Sciences*. 4(1).2016. pp.14-32.
4. Kenn-Ndubuisi. Financial Leverage and Firm Financial Performance in Nigeria: A Panel Data Analysis Approach. *Global Journal of Management and Business Research: C Finance*. 19(4). 2019. pp.13-19.
5. Dr.MohdTaqi et al. Financial Leverage and Profitability: Evidence from Oil and Gas Sector of India. *GIS Business*. 15(4). 2020. pp.665-687.
6. Barakat, A. The Impact of Financial Structure, Financial Leverage and Profitability on Industrial Companies Shares Value (Applied Study on a Sample of Saudi Industrial Companies). *Research Journal of Finance and Accounting*. 5(1). 2014. pp. 55 – 66.
7. Enekwe, C. I., Agu, C. I., and Eziedo K.N. The effect of financial leverage on financial performance: evidence of quoted pharmaceutical companies in Nigeria. *IOSR Journal of Economics and Finance (IOSR-JEF)*. 5(3). 2014. pp.17-25.
8. Dr. Sanjay J. Bhayani and Dr.ButalaAjmera. An Empirical Study on Effect of Financial Leverage on Firm's Performance and Valuation of Selected Pharmaceutical Companies In India. *Indian Journal of Accounting (IJA)*. 50(2). 2018. pp.101-110.
9. Banafa, A. S, Muturi, W and Ngugi, K. The Impact of Leverage on Financial Performance of Listed Non-Financial Firm in Kenya. *International Journal of Finance and Accounting*. 4(7). 2015. pp.1-20.
10. K. Rajamani. Debt Financing and Financial Performance: Empirical Evidence of Indian SMEs Listed in BSE-SME Plat form. *Eurasian Studies in Business and book series (EBES, volume 16/1)*. 2021.
11. Dr.Josheena Jose. A Study On The Impact Of Leverage On Financial Performance Of Selected Cement Companies In India. *Asia Pacific Journal of Research in Business Management*. 8(5). 2017. pp.40-56.
12. Mohammad Ali. Relationship between Financial Leverage and Financial Performance (Evidence of Listed Chemical Companies of Pakistan). *Research Journal of finance and Accounting*. 5(23).2014. pp.46-56.
13. M. Kannadhasan, VinayGoyal and ParikshitCharan. The Role of Financial Performance as a Moderator on the Relationship Between Financial Leverage and Shareholders Return. *Journal of Modern Accounting and Auditing*. 12(7). 2016. pp.379-387.
14. Nirujah,R., Niththiya,S., Kunalan,J., Visuvarajh,T., M,V,Adams and Kinchchili,T. Impact Of Leverage On Shareholders' Return: A Study On Selected Listed Manufacturing Companies In Sri Lanka. Published and Presented in ICCM 2014, Faculty of Management Studies and Commerce, University of Jaffna, Sri Lanka. 2014. pp.1-9.
15. I M Pandey. *Financial Management*. ISBN: 978-93259-8229-1. Eleventh Edition.Vikas Publishing House Pvt Ltd. New Delhi; 2015.

**Table-1 Chemical Companies and its Average Market Capitalization**

S.No	Chemical Companies	Average Market Capitalization Amount Rs. in Crores
1	Pidilite Industries Ltd	94591.28
2	UPL Limited	49374.59
3	Aarti Industries Ltd	25107.74
4	Atul Limited	22243.86
5	Deepak Nitrite Limited	20469.18
6	Tata Chemicals Ltd	17216.03
7	Vinati Organics Ltd	15763.27
8	Navin Fluorine International Limited	14446.3
9	Alkyl Amines Chemicals Ltd	13476.94
10	Solar Industries India Limited	11935.84
11	BASF India Ltd	9168.87
12	Balaji Amines Ltd	6310.47





**Rifana and Geetha**

13	Rallis India Ltd	5606.83
14	Sudarshan Chemical Industries Ltd	4002.24
15	DhanukaAgritech Ltd	3746.36

Source: AMFI January- June 2021

**Table-2 Panel Regression Models**

S.no	Model	s.no	Model
1	$CR = \alpha + \beta_1DR + \beta_2DER + \epsilon$	4	$NPR = \alpha + \beta_1DR + \beta_2DER + \epsilon$
2	$ICR = \alpha + \beta_1DR + \beta_2DER + \epsilon$	5	$ROE = \alpha + \beta_1DR + \beta_2DER + \epsilon$
3	$TATR = \alpha + \beta_1DR + \beta_2DER + \epsilon$	6	$EPS = \alpha + \beta_1DR + \beta_2DER + \epsilon$

**Table-3 Variables Description**

Concept	Variables	Measures
Financial leverage	(DR)Debt Ratio (DER)Debt Equity Ratio	Debt to Total asset Debt to Equity
Financial Performance (Dependent variable)	(CR) Current Ratio- Liquidity (ICR)Interest Coverage Ratio - Solvency  (TATR)Total Asset Turnover Ratio- Efficiency  (NPR)Net Profit Ratio-Profitability	Current Asset to Current Liability (measures short term solvency) Earnings before Interest &Tax to Interest (measure debt servicing capacity of the firm) Sales to Total Asset (measure of firm’s ability in generating sales from asset) Net Profit to Sales (measure firm’s overall profitability).
Shareholders’ Return (Dependent variable)	(ROE)- Return on Equity (EPS)- Earnings per Share	Net Profit to Total Equity Profit after tax to Number of shares outstanding

Source: IM Pandey book

**Table-4 Descriptive Statistics**

	Observation	Mean	Standard Deviation	Variance	Minimum	Maximum	Skewness	Kurtosis
<b>DR</b>	225	0.19	0.15	0.02	0.00	0.50	0.16	-1.31
<b>DER</b>	225	0.49	0.46	0.21	0.00	1.78	0.71	-0.54
<b>CR</b>	225	1.84	1.10	1.21	0.58	7.22	2.78	9.12
<b>ICR</b>	225	56.36	201.88	4.08	-0.66	2348.56	8.77	89.06
<b>TATR</b>	225	1.03	0.30	0.09	0.20	1.86	-0.22	0.28
<b>NPR</b>	225	0.11	0.16	0.03	0.00	2.34	11.51	155.38
<b>ROE</b>	225	0.18	0.09	0.01	-0.06	0.57	0.58	1.33
<b>EPS</b>	225	28.36	38.02	1.45	-15.45	268.50	3.49	15.37

Source: Computed Data (Note: All the values are rounded to 2 decimal points)





**Rifana and Geetha**

**Table-5 Breusch-Pagan and Hausman Test for Current Ratio**

	<b>Cross-Section</b>	<b>Time</b>	<b>Both</b>
Breusch-Pagan Statistic P- value	46.79487 (0.0000)	0.264325 (0.6072)	47.05919 (0.0000)
	<b>Chi-Sq. value</b>	<b>d.o.f</b>	<b>Prob.</b>
Hausman Test "Cross-section Random"	5.911629	2	0.0420

Source: Computed Data

**Table-6 Fixed Effect Model for Current Ratio**

<b>Dependent Variable:</b> CR		
<b>Sample:</b> 2007 to 2021		
<b>Total Observations:</b> Cross-section x Period (15 x 15= 225)		
	<b>Coefficient</b>	<b>Prob.</b>
C	2.456568	0.0000
DR	-5.799060	0.0005
DER	-1.001034	0.0601
R-Sq. value		0.354340
Adjusted R-Sq.		0.304674
F-Statistic		7.134444
P-value		0.000000

Source: Computed Data

**Table-7 Breusch-Pagan and Hausman Test for Interest Coverage Ratio**

	<b>Cross-Section</b>	<b>Time</b>	<b>Both</b>
Breusch-Pagan Statistic P- value	0.164294 (0.6852)	0.143968 (0.7044)	0.308262 (0.5787)

Source: Computed Data

**Table- 8 Pooled Ordinary Least Square for Interest Coverage Ratio**

<b>Dependent Variable:</b> ICR		
<b>Sample:</b> 2007 to 2021		
<b>Total Observations:</b> Cross-section x Period (15 x 15= 225)		
	<b>Coefficient</b>	<b>Prob.</b>
C	121.0496	0.0000
DR	-435.5073	0.0493
DER	-38.42441	0.0692
R-Sq. value		0.156112
Adjusted R-Sq.		0.147608
F-Statistic		6.598696
P-value		0.001645

Source: Computed Data





**Rifana and Geetha**

**Table-9 Breusch-Pagan and Hausman Test for Total Asset Turnover Ratio**

	<b>Cross-Section</b>	<b>Time</b>	<b>Both</b>
Breusch-Pagan Statistic P- value	517.0423 (0.0000)	1.427501 (0.2322)	518.4698 (0.0000)
	<b>Chi-Sq. value</b>	<b>d.o.f</b>	<b>Prob.</b>
Hausman Test "Cross-section Random"	6.045160	2	0.0487

Source: Computed Data

**Table-10 Fixed Effect Model for Total Asset Turnover Ratio**

<b>Dependent Variable: TATR</b>		
<b>Sample: 2007 to 2021</b>		
<b>Total Observations: Cross-Section x Period (15 x 15= 225)</b>		
	<b>Coefficient</b>	<b>Prob.</b>
C	0.990552	0.0000
DR	-1.034341	0.0017
DER	-0.330834	0.0017
R-Sq. value		0.654891
Adjusted R-Sq.		0.628344
F-Statistic		24.66926
P-value		0.000000

Source: Computed Data

**Table-11 Breusch-Pagan and Hausman Test for Net Profit Ratio**

	<b>Cross-Section</b>	<b>Time</b>	<b>Both</b>
Breusch-Pagan Statistic P- value	9.767746 (0.0018)	0.177650 (0.6734)	9.945396 (0.0016)
	<b>Chi-Sq. Value</b>	<b>d.o.f</b>	<b>Prob.</b>
Hausman Test "Cross-section Random"	7.436925	2	0.0243

Source: Computed Data

**Table-12 Fixed Effect Model for Net Profit Ratio**

<b>Dependent Variable: NPR</b>		
<b>Sample: 2007 to 2021</b>		
<b>Total Observations: Cross-section x Period (15 x 15= 225)</b>		
	<b>Coefficient</b>	<b>Prob.</b>
C	0.198631	0.0000
DR	-0.785605	0.0039
DER	-0.126015	0.0460
R-Sq. value		0.226311
Adjusted R-Sq.		0.166796
F-Statistic		3.802616
P-value		0.000003

Source: Computed Data





**Rifana and Geetha**

**Table-13 Breusch-Pagan and Hausman Test for Return on Equity**

	<b>Cross-Section</b>	<b>Time</b>	<b>Both</b>
Breusch-Pagan Statistic P- value	170.6489 (0.0000)	0.934178 (0.3338)	171.5831 (0.0000)
	<b>Chi-Sq. value</b>	<b>d.o.f</b>	<b>Prob.</b>
Hausman Test "Cross-section Random"	0.781785	2	0.6765

Source: Computed Data

**Table-14 Random Effect Model for Return on Equity**

<b>Dependent Variable: ROE</b>		
<b>Sample: 2007 to 2021</b>		
<b>Total Observations: Cross-section x Period (15 x 15= 225)</b>		
	<b>Coefficient</b>	<b>Prob.</b>
C	0.198577	0.0000
DR	-0.144155	0.0262
DER	-0.085571	0.0390
R-Sq. value		0.148235
Adjusted R-Sq.		0.129660
F-Statistic		5.625402
P-value		0.004138

Source: Computed Data

**Table-15 Breusch-Pagan and Hausman Test for Earnings per Share**

	<b>Cross-Section</b>	<b>Time</b>	<b>Both</b>
Breusch-PaganStatistic P- value	114.2891 (0.0000)	0.059583 (0.8072)	114.3487 (0.0000)
	<b>Chi-Sq. value</b>	<b>d.o.f</b>	<b>Prob.</b>
Hausman Test "Cross-section Random"	2.945406	2	0.2293

Source: Computed Data

**Table-16 Random Effect Model for Earnings per Share**

<b>Dependent Variable: EPS</b>		
<b>Sample: 2007 to 2021</b>		
<b>Total Observations: Cross-section x Period (15 x 15= 225)</b>		
	<b>Coefficient</b>	<b>Prob.</b>
C	49.74334	0.0000
DR	-111.8062	0.0382
DER	-0.170404	0.0992
R-Sq. value		0.158744
Adjusted R-Sq.		0.151165
F-Statistic		20.94550
P-value		0.000000

Source: Computed Data





**Rifana and Geetha**

**Table-17 Goodness of fit index measurement model of the Selected Variables**

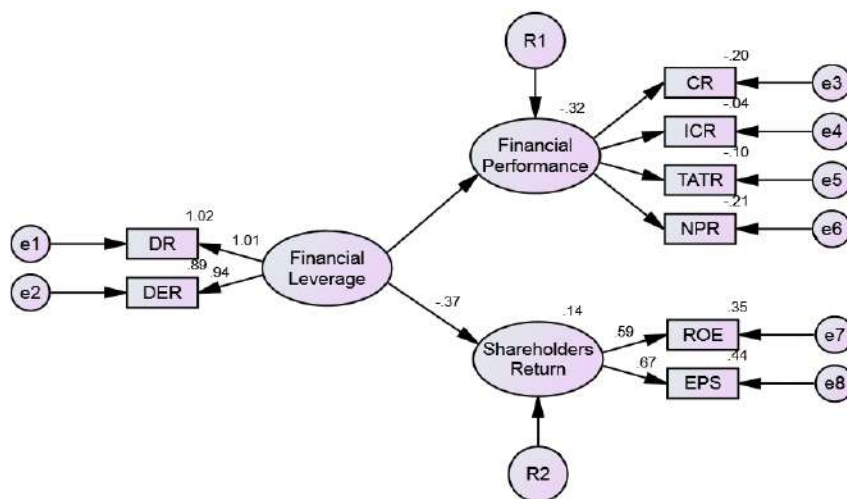
Fit indices		Model value	Recommended value
Chi-square	(x <sup>2</sup> )	33.463	-
	DF	15	-
	P value	.004	P<=0.05
	x <sup>2</sup> / Df	2.231	-
RMSEA "Root Mean square Error of Approximation"		.074	Acceptable Fit: Value between 0.05 and 0.08
CFI "Comparative Fit Indices"		.979	Value > 0.90
GFI "Goodness of Fit Index"		.964	Value close to 0.90 or 0.95
NFI "Normed Fit Index"		.963	Value > 0.90
AGFI "Adjusted Goodness of Fit Index"		.913	Value close to 0.90
TLI "Tucker-Lewis Index"		.960	Good fit when Value close to 0.90 or 0.95

Source: Computed Data

**Table-18 Regression Weights of the overall Model**

Measured Variable		Latent Variable	Estimates	SE	CR	P	Result
Financial Performance	<---	Financial	1.000				Significant
Shareholders Return	<---	Leverage	-.137	.032	-4.250	.000	Significant
Debt Ratio	<---	Financial	1.000				Significant
Debt Equity Ratio	<---	Leverage	2.890	.122	23.614	.000	Significant
Current Ratio	<---	Financial Performance	1.000				Significant
Interest Coverage Ratio	<---		-154.146	51.179	-3.012	.003	Significant
Total Asset Turnover Ratio	<---		-.351	.082	-4.271	.000	Significant
Net Profit Ratio	<---		-.279	.065	-4.287	.000	Significant
Return on Equity	<---	Shareholders	1.000				Significant
Earnings per Share	<---	Return	456.577	61.170	7.464	.000	Significant

Source: Computed Data (SE- Standard Error, CR- Critical ratio)



**Fig.1.SEM Overall Model**





## Assessment of Bioactive Phytochemicals with GC-MS Analysis Technique and Antioxidant Activity of *Ziziphus mauritiana* L. Leaves

Bhimraj Gawade\*

Assistant Professor, Department of Chemistry, Anandrao Dhonde College, Kada - 414 202, (M.S.) India.

Received: 16 Nov 2021

Revised: 24 Dec 2021

Accepted: 11 Jan 2022

### \*Address for Correspondence

#### Bhimraj Gawade

Assistant Professor,

Department of Chemistry,

Anandrao Dhonde College,

Kada - 414 202, (M.S.) India.

Email: bhimrajgawade@gmail.com



This is an Open Access Journal / article distributed under the terms of the **Creative Commons Attribution License** (CC BY-NC-ND 3.0) which permits unrestricted use, distribution, and reproduction in any medium, provided the original work is properly cited. All rights reserved.

### ABSTRACT

The aim of this study was to assess phytochemicals with GC-MS analysis technique and antioxidant activity of *Ziziphus mauritiana* L. plant leaves ethanol extract by using DPPH *in vitro* system. GC-MS analysis of ethanol extract were reported seven peaks of phytochemicals as 4-Iodo-2-Methyl-1-Butene, 3,5-Bis(1,1-Dimethylethyl)-Phenol, Neophytadiene, 2-Decen-1-ol, 6-Octen-1-ol, 3,7-Dimethyl-, Propanoate, 3,7,11,15-Tetramethyl-2-Hexadecen-1-ol and Squalene. The provided evidence of results concluded that the ethanol extract of *Ziziphus mauritiana* L. leaves are potential sources of natural bioactive phytochemicals and showed significant growth inhibition *in vitro* antioxidant activity with their IC<sub>50</sub> value 41.90±0.03 µg/mL. Therefore, bioactive phytochemicals reported in *Ziziphus mauritiana* L. medicinal plant leaves ethanol extract were responsible for effective antioxidant properties with significant advantages to human health.

**Keywords:** *Ziziphus mauritiana* L., ethanol extract, GC-MS, DPPH, Antioxidant.

### INTRODUCTION

Antioxidants are the chemical constituents that neutralize free radicals, otherwise which damages the crucial bio-molecules present in body. Free radicals are chemically active product of metabolism and include reactive oxygen species or reactive nitrogen species. Appearance of radicals originates a number of human neurologic and other metabolic disorders [1]. These different type of pathological disorders such as cancer, cataracts, chronic inflammation as well as diabetes mellitus, cardiovascular and neurodegenerative diseases believed to the associated with oxidative stress [2-3]. Artificially Synthesized antioxidants have been widely used for treatment the pathological conditions. The regular use of these synthetic antioxidants in food preparations have been questioned due to potential health risks, toxicity and carcinogenicity [4-5]. Majority of the diseases today are due to the shift in the balance of the pro-oxidant





**Bhimraj Gawade**

and the antioxidant homeostatic phenomenon in the body. Pro-oxidant conditions dominate either due to the increased generation of the free radicals or due to the excessive oxidative stress of the depletion of the dietary antioxidant [6]. The presence of bioactive phytochemicals in the widely distributed medicinal plants have been gained much attention, due to presence of various types of curative agents and their pharmacological activities were used as variety of ailments [7-8]. Many plants exhaustively studied in the last few years for their antioxidant and radical scavenging activities [9-10]. Physicochemical analysis of *Ziziphus mauritiana* L. leaves extract has been reported presence of triterpenoids, steroids, flavonoids, saponins, tannins and carbohydrate. The reported contents include phenol and flavonoids are responsible for antioxidant and anti-inflammatory and other biological activities [11]. The *Ziziphus mauritiana* L. plants leaves are one of the cheapest sources of feeding for animals having crude proteins [12]. *In vitro* antioxidant potential of the *Ziziphus mauritiana* L. leaves ethanol extract was investigated, but has less informative. Therefore, taking into consideration the vast potentiality of *Ziziphus mauritiana* L. plant leaves as source of antioxidants, a systematic investigation was undertaken to study.

## MATERIALS AND METHODS

### Plant material

The leaves of *Ziziphus mauritiana* L. plant were collected from Limbodi dam area and authenticated with the help of our institute botanist.

### Extraction

The leaves of *Ziziphus mauritiana* L. plant were dried under shade and then powdered. 10 g of powdered material was dissolved in 100 mL of ethanol and kept on a magnetic stirrer for 2 h. Thereafter, it was extracted using a soxhlet apparatus sequentially with ethanol. The extract was collected and the solvent evaporated out to dryness. The obtained material was stored in airtight bottle for further studies.

### Evaluation of DPPH radical scavenging activity

The free radical scavenging activity was measured by using stable free radical DPPH (2, 2-diphenyl-1-picrylhydrazyl) with the help of UV spectrophotometer [13-14]. A stock solution of 0.1mM DPPH was prepared in ethanol. 1.0 mL of this solution was added to 1.0 mL of extract solution in water at different concentrations (5-50 µg/mL) and final volume was adjusted to 3 mL by adding water. After 15 min., the absorbance of each concentration was measured at 517 nm. Ascorbic acid was used as standard. The decrease in absorbance of the reaction mixture indicates presence of free radical scavengers. Percentage scavenges of DPPH radical by test compound were determined as % Scavenged Activity =  $(A_{\text{Control}} - A_{\text{Test}} / A_{\text{Control}}) \times 100$   
IC<sub>50</sub> value was calculated by using graphical method.

### Phytochemical analysis

The dried extract powder was analysed by qualitative chemical test to identify bioactive phytochemical constituents present in the leaves according to the standard protocol procedures of the presence of alkaloids, glycosides, tannins, saponins, flavonoids and phenols [15-17].

### GC-MS analysis

GC-MS analysis was carried out on Shimadzu GC-MS model number QP 2010S. The column Rxi-5Sil MS, 30 meter length, 0.25 mm ID, 0.25 µm thickness was used. The organic compounds were identified by comparison of mass spectra with the inbuilt libraries NIST-11 and WILEY-8. The reported components of the test extract powder were tabulated.



**Bhimraj Gawade****Statistical analysis**

The experimental tests were performed triplicate in three sets and the results expressed in mean  $\pm$  SD. Values of  $p < 0.05$  were considered as statistically significant.

**RESULTS AND DISCUSSION**

*In vitro* antioxidant activity of *Ziziphus mauritiana* L. leaves ethanol extract was tested by DPPH assay method. The dose response curve of DPPH for ethanol extract of *Ziziphus mauritiana* L. leaves was correlated with reference standard ascorbic acid (Fig.1). The control ascorbic acid as a reference compound, shows the highest activity at all concentrations with  $IC_{50}$  value of  $15.84 \pm 0.02$   $\mu\text{g/mL}$  in DPPH assay and test samples has their  $IC_{50}$  value  $41.90 \pm 0.03$   $\mu\text{g/mL}$  (Table-1). This indicates that ethanol extract of *Ziziphus mauritiana* L. leaves has good potential as a source of natural antioxidants [18]. Phytochemical analysis of *Ziziphus mauritiana* L. leaves extract showed the presence of different chemical constituents such as phenols, tannins, flavonoids, alkaloids, saponins and terpenoids (Table-2). The researchers also reported some biological activities and phytochemical constituents like cardiac glycosides, polyphenols, saponins and tannins are presented in *Ziziphus mauritiana* L. leaves [19-20]. They were studied Sterols like  $\beta$ -sitosterol, terpenoid, phytosterols, triterpenoids, alkaloids, saponins, flavonoids, glycosides and tannins have antioxidant activity [21-22]. In GC-MS analysis (Fig. 2) of ethanol extract were reported seven peaks of phytochemical contents as 4-Iodo-2-Methyl-1-Butene, 3,5-Bis(1,1-Dimethylethyl)- Phenol, Neophytadiene, 2-Decen-1-ol, 6-Octen-1-ol, 3,7-Dimethyl-, Propanoate, 3,7,11,15-Tetramethyl-2-Hexadecen-1-ol and Squalene [23-24] (Table-3). Phenolic and flavonoid contents are responsible for antioxidant activity [25], because they are effective hydrogen donors, which make them antioxidant [26-27]. The phenolic and flavonoid compounds reported from *Ziziphus mauritiana* L. may be responsible for antioxidant activity [28-29]. The observed antioxidant activity of extract of this plant could be as a result of the presence of these bioactive chemical constituents [30-31].

**CONCLUSIONS**

The present assessment report of GC-MS analysis and antioxidant activity study of *Ziziphus mauritiana* L. leaves ethanol extract revealed presence of seven phytochemicals. Antioxidant activity assessment study of ethanol extract denotes free radical scavenging activity. The overall antioxidant activity depends on phytochemical constituents present in the leaves. That could be a source of natural antioxidant and have greater importance as therapeutic agent in preventing or slowing oxidative stress related degenerative diseases. Therefore, the result of assessment study could be useful for further research on antioxidant activity to identify natural potential bioactive molecules from ethanol extract of *Ziziphus mauritiana* L. plant.

**ACKNOWLEDGEMENTS**

Authors are thankful to the Director, KFRI, Thrissur, Kerala, Research Institute, Maulana Azad College, Principal and Head of Department of our college for motivation, support and providing necessary facilities to carry out study.

**REFERENCES**

1. Nadkarni KM. Indian Materia Medica, 3rd Edn, Dhootapapeshwar Prakashan, Ltd. Bombay 1954; 1:353.
2. Pelicano H, Carney D, Huang P. ROS stress in cancer cells and therapeutic implications. Drug Resist Update 2004; 7:97-10. doi:10.1016/j.drup.2004.01.004
3. Gonçalves C, Dinis T, Batista MT. Antioxidant properties of proanthocyanidins of *Uncaria tomentosa* bark decoction: a mechanism for anti-inflammatory activity. Phytochemistry 2005; 66:89-98. doi:10.1016/j.phytochem.2004.10.025



**Bhimraj Gawade**

4. Jeong S, Kim S, Kim D, Jo S, Nam K, Ahn D, Lee S. Effect of heat treatment on the antioxidant activity of extracts from citrus peels. *J Agric Food Chem* 2004; 52:3389-93. doi: 10.1021/jf049899k
5. Wong SP, Leong LP, Koh JHW. Antioxidant activities of aqueous extracts of selected plants. *Food Chem* 2006; 99:775-83. doi: 10.1016/j.foodchem.2005.07.058
6. Priyesh P, Narayanasamy VB, Manjunatha Setty M, Annie S. Antioxidant potential of *Clerodendron viscosum vent.* Roots. *Pharmacology online* 2007; 2: 226-35.
7. Moh San AM, Thongpraditchote S, Sithisarn P, Gritsanapan W. Total phenolics and total flavonoids contents and hypnotic effect in mice of *Ziziphus mauritiana* Lam. seed extract. *Evidence-Based Comp Alt Med* 2013; 1-4. <https://doi.org/10.1155/2013/835854>
8. Hossain MA. A phytopharmacological review on the Omani medicinal plant: *Ziziphus jujube*. *J King Saud Uni Sci* 2019; 31: 1352-57. <https://doi.org/10.1016/j.jksus.2018.12.003>
9. Arnous A, Makris DP, Kefalas P. Effect of principal polyphenolic components in relation to antioxidant characteristics of aged red wines. *J Agric Food Chem* 2001; 49:5736-42. doi: 10.1021/jf010827s
10. Gawade B, Farooqui M. Antioxidant activity from ethanol extract of *Bauhinia Racemosa Lam.* leaves. *Int J Chem Phys Sci* 2018; 7(Special Issue): 67-72.
11. Kushwaha P, Yadav SS, Singh V, Dwivedi LK. GC-MS analysis of bio-active compounds in methanolic extract of *Ziziphus mauritiana* fruit. *Int J Pharm Sci Res* 2019; 10(6): 2911-16. doi: 10.13040/IJPSR.0975-8232.10(6).2911-16
12. Abdu SB, Ehoche OW, Adamu AM, Yashim SM, Jokthan GE. Evaluation of processing methods on biochemical composition of *Ziziphus (Ziziphus mauritiana)* leaf meal. *Trop J Anim Sci* 2007; 10(1-2):441-43.
13. Blois MS. Antioxidant determination by the use of stable free radical. *Nature* 1958; 181:1199-200. doi: 10.1038/1811199a0
14. Shendge P, Patil L, Kadam V. *In vitro* evaluation antioxidant activities of *Dillenia Indica Linn.* leaf extract. *Int J Pharm Sci Res* 2011; 2(7):1814-18. [http://dx.doi.org/10.13040/IJPSR.0975-8232.2\(7\).1814-18](http://dx.doi.org/10.13040/IJPSR.0975-8232.2(7).1814-18)
15. Gawade B, Farooqui M. Screening of phytochemicals and *in vitro* antidiabetic activity of *Bauhinia racemosa lam.* leaves. *Asian J Pharm Clin Res* 2018; 11(6): 190-93. <https://doi.org/10.22159/ajpcr.2018.v11i6.24038>
16. Tiwari P, Kumar B, Kaur M. Phytochemical screening and extraction: A review. *Int Pharm Scientia* 2011; 1(1):98-06.
17. Gawade BN, Farooqui M. *In vitro* alpha amylase inhibitory activity study of *Zizyphus mauritiana* leaves ethanol extract. *J Med Chem Drug Disc* 2017; 3(3): 67-76.
18. Keita S, Wele M, Ciss C, Togola I, Diarra N, Baba-Moussa L. Phytochemistry and biological activities of leaves and pulp extracts from *Ziziphus mauritiana* (Lam.) collected in Mali. *J Adv Bio Biotech* 2020; 23(1): 1-10.
19. Emad MA, Eman RE, Abdelaziz E. Biological activities of methanolic leaf extract of *Ziziphus mauritiana*. *Biosci Biotech Res Comm* 2016; 9(4): 605-14. doi: 10.21786/bbrc/9.4/6
20. Abalaka ME, Mann A, Adeyemo SO. Studies on *in vitro* antioxidant and free radical scavenging potential and phytochemical screening of leaves of *Ziziphus mauritiana* L. and *Ziziphus spinachristi* L. compared with Ascorbic acid. *J Med Gen and Genom* 2011; 3(2): 28-34.
21. Dragland SM, Senoo H, Wake K, Holte K, Blomhoff R. Antioxidant activity of Terpenoids. *J Nutr* 2003; 133:1286-90.
22. Cai YZ, Luo Q, Sun M, Corke H. Antioxidant activity of Sterols ( $\beta$ -sitosterol). *Life Sciences* 2004; 74: 2157-84.
23. Ramar MK, Nambirajan G, Thilagar, Kandasamy R. Profiling of bioactive components present in *Ziziphus mauritiana* Lam for *In-vitro* antioxidant and *In-vivo* anti-inflammatory activities. *Int Res J Pharm* 2017; 8 (9): 19-24. doi:10.7897/2230-8407.089153
24. Patil T. and Khan S. Phytochemical Screening and Determination of Bioactive Constituents of Methanolic Leaf Extract of *Ziziphus jujuba* (Mill.). *Ind J Pure App Biosci.* 2021; 9 (2): 34-40. <http://dx.doi.org/10.18782/2582-2845.8655>
25. Zhang L, Liu P, Li L, Huang Y, Pu Y, Hou X, Song L. Identification and antioxidant activity of flavonoids extracted from xinjiang jujube (*Ziziphus jujube* Mill.) leaves with ultra-high pressure extraction technology. *Molecules* 2019; 24(122):1-14. doi: 10.3390/molecules24010122
26. Rice-Evans CA, Miller NJ, Bolwell PG, Bramley PM, Pridham JB. The relative antioxidant activity of plant derived polyphenolic flavonoids. *Free Radic Res* 1995; 22:375-83. doi: 10.3109/10715769509145649





### Bhimraj Gawade

27. Vijay C, Ramanathan M, Subburaj T, Sures B. Correlation of Phenolic Content and *in vitro* Antioxidant Activity of certain herbal extracts, Indian Drugs 2002; 3:453-55.
28. Jain P, Haque A, Islam T, Alam MA, Reza HM. Comparative evaluation of *Ziziphus mauritiana* leaf extracts for phenolic content, antioxidant and antibacterial activities. J Herbs, Spices Med Plants 2019; 25(3): 236-58. <https://doi.org/10.1080/10496475.2019.1600627>
29. Qasim M, Abideen Z, Khan MA. Antioxidant properties, phenolic compositions, bioactive compounds and nutritive value of medicinal halophytes commonly used as herbal teas. South African J Bot 2017; 110:240-50. <https://doi.org/10.1016/j.sajb.2016.10.005>
30. Khanal LN, Sharma KR, Pokharel YR and Kalauni SK. Assessment of phytochemical, antioxidant and antimicrobial activities of some medicinal plants from Kaski district of Nepal. Am J Plant Sci. 2020; 11: 1383-1397. <https://doi.org/10.4236/ajps.2020.119099>
31. Soni H and Malik JK, Sch. Phyto-Pharmacological Potential of Zizyphus jujube: A Review. Int J Biochem. 2021; 4 (2): 1-5. doi: 10.36348/sijb.2021.v04i01.001

**Table-1 DPPH free radical scavenging activities of standard and *Ziziphus mauritiana* L. leaves extract**

Concentration (µg/mL)	% Scavenged of standard	% Scavenged of extract
5	43.02±0.04	25.69±0.03
10	45.81±0.02	29.18±0.04
20	53.07±0.03	41.89±0.00
30	55.45±0.00	46.22±0.02
40	59.78±0.02	48.74±0.01
50	62.71±0.01	55.44±0.04
<b>IC<sub>50</sub> Value (µg/mL)</b>	15.84±0.02	41.90±0.03

**Table-2 Phytochemical analysis of *Ziziphus mauritiana* L. leaves extract**

Phytochemicals	Result
1. Alkaloid	+
2. Carbohydrate	-
3. Protein and amino acids	-
4. Glycoside	-
5. Tannin	+
6. Saponin	+
7. Flavonoids	+
8. Steroids	-
9. Triterpenoids	+
10. Phenolic compound	+

(+ for present and - for absent)

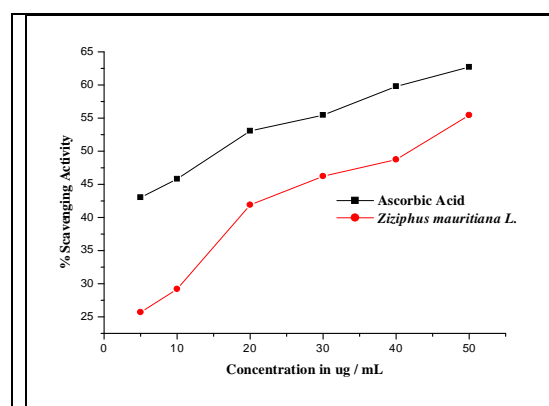




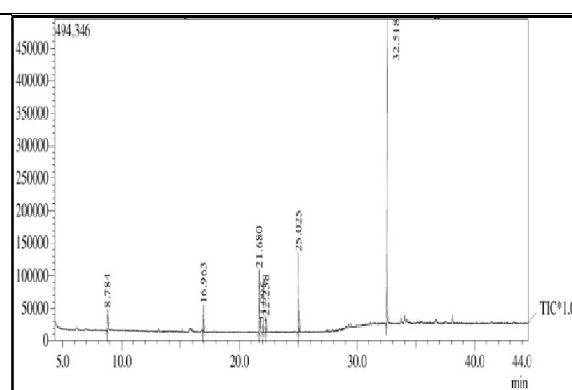
**Bhimraj Gawade**

**Table-3 Phytochemicals detected by GC-MS analysis of *Ziziphus mauritiana* L. leaves ethanol extract**

Peak#	R. Time	Compound Name	Chemical Structure	Base m/z	Molecular formula
1	8.784	4-Iodo-2-Methyl-1-Butene		43.05	C <sub>5</sub> H <sub>9</sub> I
2	16.963	3,5-Bis(1,1-Dimethylethyl)-Phenol		191.15	C <sub>14</sub> H <sub>22</sub> O
3	21.680	Neophytadiene		68.05	C <sub>20</sub> H <sub>38</sub>
4	21.996	2-Decen-1-ol		41.00	C <sub>10</sub> H <sub>22</sub> O
5	22.238	6-Octen-1-ol, 3,7-Dimethyl-, Propanoate		82.05	C <sub>13</sub> H <sub>24</sub> O <sub>2</sub>
6	25.025	3,7,11,15-Tetramethyl-2-Hexadecen-1-ol		43.05	C <sub>20</sub> H <sub>40</sub> O
7	32.518	Squalene		69.05	C <sub>30</sub> H <sub>50</sub>



**Fig. 1 DPPH Free Radical Scavenging Activity of *Ziziphus mauritiana* L. leaves extract**



**Fig. 2 GC-MS Chromatogram of *Ziziphus mauritiana* L. leaves ethanol extract**





## The Medicinal and Scientific uses of Kava Plant: A Review

Manish Yadav\*

Assistant Professor Grade - III, Department of Pharmacy, School of Medical & Allied Sciences (SoMAS), GD Goenka University, Gurugram, Haryana, India.

Received: 18 Nov 2021

Revised: 19 Dec 2021

Accepted: 17 Jan 2022

### \*Address for Correspondence

#### Manish Yadav

Assistant Professor Grade - III,  
Department of Pharmacy,  
School of Medical & Allied Sciences (SoMAS),  
GD Goenka University,  
Gurugram, Haryana, India.  
Email: rao.manish70@yahoo.co.in



This is an Open Access Journal / article distributed under the terms of the **Creative Commons Attribution License** (CC BY-NC-ND 3.0) which permits unrestricted use, distribution, and reproduction in any medium, provided the original work is properly cited. All rights reserved.

### ABSTRACT

Piper methysticum found in the Pacific island region. Kava beverages are prepared from the roots of Piper methysticum generally used as a traditional drink. The kava plant has been known for treating anxiety, dealing with depression, and its dopamine releasing quality for a long time. Even though kava plants have a phenomenal effect on health in many ways, but excess of anything leads to consequences. This paper also discusses the paradox theory related to kava plant and its extract. The research-backed health benefits of kava plant shows other benefits also and not only limited to anxiety and depression but even covers issues such as premenstrual syndrome. It also shows that there could be cases of insomnia relief with kava plant and its extract. This paper explains about the uses of kava as a sleeping aid and the cons related to its ingestion. These caveats for using kava as a sleeping aid are clearly mentioned in the paper. Kava can cause some serious problems if used for long term i.e. Hepatotoxicity. The extent upto which it is safe to use kava plants and way to consume them and different forms of kava plant available in the market for consumption. Kava plant also used for smoking induces lung cancer. There are so many health benefits but it is important to use kava after consult with physician.

**Keywords:** Piper methysticum, Kava, Anxiety, Depression, Insomnia, Hepatotoxicity, Lung cancer

### INTRODUCTION

The plant kingdom has evolved and helped human civilization for generations. The studies on different plants gave us humans the key to overcome most of the health-related problems. Kava plant holds very specific importance in the medical field and also in the lives of many people across the world (Fragoulis, 2017). The plant often goes unnoticed, but it is the remedy that many people across the world use to relieve stress, boost sleep, and relieve



**Manish Yadav**

anxiety. Studies have shown that the extract from the kava plant has a euphoric and calming effect on the body, which some people strongly argue over alcohol. Pacific Kava plant or *Piper methysticum* is used for various reasons all across the world. Kava, however, is a herbal remedy extracted from the roots of the kava plant. Kava plants are mostly found on the islands of the Pacific Ocean. This plant has been a part of tradition for centuries due to its medicinal use (Pollstri, 2009). Traditionally the locals have been consuming in the form of beverages. The remedy goes with drying the roots and then crushing the roots to powder. The powder is then added to the water before consumption. The effects of the kava plant have had significant results. The effects vary from making the brain and body relaxed, calm and happy. The kava plant triggers the release of dopamine. Apart from these effects, the plant also helps in relieving the pain and helps the muscles relax. Also, it has been used to prevent seizures (Teschke, 2011). Kava plants have been used to treat anxiety for a long time. However, a generalized anxiety disorder which most younger people suffer from. During the menstrual period, there are several things that a woman goes through. The most prominent of which is the physical and emotional symptoms (Teschke, 2021). However, there are certain cases when a woman gets these imbalances before the menstrual cycle starts. This condition is known as Premenstrual syndrome or PMS. The Kava plant has had many uses, but it has the upper hand in treating women suffering from Premenstrual Syndrome or PMS.

**The Neurobehavioral effects of Kava**

The kava plant is largely used in the South Pacific region as well as in the northern part of Australia. Due to its many medicinal properties, it is now being used in the pharmaceutical industry widely across the world. The Kava is widely known in the western hemisphere as herbal medicine or herbal supplement (Teschke, 2012). The effects of Kava on animals in the animal study have shown that the kavalactones alter neuronal excitation. The kavalactones excitation interacts with voltage-dependent ion channels. This increases the property of Kava's muscle relaxant. This neuronal excitation on interaction also increases many properties of the kava plant. Due to this, the kava plant has shown anaesthetic anticonvulsive and anxiolytic properties (Peterson, 2019). Following these discoveries, many types of research were conducted on several isolated cases of psychotic and dystonic. The results suggested that the kava plant also possesses psychoactive properties. However, there is no proof that the kava plant interferes with normal conscious intellectual activity like reasoning, thinking, etc. Kava has proven several times that it has been an effective remedy in the treatment revolving around tension, anxiety, and stress (Tengfei, 2020). This has raised several questions on the psychoactive behaviour of the plant on its users. The nature of the kava plant on neurons is not completely studied.

**Kava uses in rare Hepatotoxicity**

The pacific herb is consumed all over the world for treating anxiety. The kava plant has also been used for recreational purposes, which are again used for treating generalized anxiety. Kava has been regularly associated with rare Hepatotoxicity (Kholi, 2011). This restricted the use of traditional aqueous extracts to the western acetic and ethanolic extracts. On the other hand, several cases from the WHO report suggested that the same Hepatotoxicity can be caused due to the traditional aqueous extracts used in New Caledonia, the USA, Australia, and Germany.

**The paradox theory**

The paradox theory restricted the use of Kava, and the Pacific herb consumed all over the world for various purposes. The paradox theory was completely based on Hepatotoxicity, which is rare (Connor, 2021). The reports presented at World Health Organization suggested that the primary cause of the toxicity was not the herb. However, the poor quality of raw material caused by hepatotoxins to be the real cause of Hepatotoxicity. Regarding this, testing on the Kava raw material is advised.





Manish Yadav

### Is it safe to use Kava?

Kava plant has been a traditional plant for centuries for people living in the Pacific region. The use of kava plants has been helpful for people for various reasons (Olsen, 2011). The pacific herb has been recommended by doctors all around the world for treating anxiety and to gain calming effect. However, even the doctors and research suggest that the prescribed use of the kava plant while consuming. Usually, the Doctor suggests taking it in the smallest dose that too not extending the time limit for more than three months (Chou, 2013). The use of the kava plant can be having many adverse effects on the user if it is used while the user regularly consumes alcohol. Here is a list of common side effects that can be seen when Kava is consumed in more than the prescribed quantity.

**Headaches:** The more this plant helps us to relax, it also takes toll on itself. The headaches are very common when Kava is consumed in more than recommended quantity.

**Dizziness:** Kava plant has been used for centuries to help the muscles relax. The excessive dosage of the kava plant while relaxing muscles can cause dizziness in the body (Fasinu, 2012).

**Fatigue:** Fatigue is the most common side effects the user experience when he/she consumes the pacific herb. It is often seen in people diagnosed with anxiety and muscle-relaxing therapy.

**Depression:** Anything in excess is harmful, and this is proof that excessive use of the Kava plant can cause depression. However, the depression is caused due to long-term regular use of the kava plant.

**Diarrhoea:** Another side effect that is seen most commonly in people using Kava is the problem of diarrhoea.

**Skin problems:** People who have been using Kava for a long period with large doses have had skin problems. The dry, yellow, or scaly appearance of the skin is most commonly seen in people who use large quantities of Kava.

Apart from these, one of the serious problems that caught the attention of people all around the world was the reports of liver damage caused due to kava supplements (Kong, 2018). The herb was associated with cirrhosis, also known as liver scarring, hepatitis which is irritation on the liver, and liver failure. However, since the reports date back to 2002 and there is no specific evidence that indicated kava supplements (Lebot, 1997). Though few countries like France and Canada have banned the usage of Kava. Later after other aqueous herbs showed similar reactions, which later indicated that the problems were caused due to improper use of raw material.

### Research-Backed Health Benefits

Traditionally on the pacific islands or in the northern part of the continent of Australia, where the kava plant is found, the plant was used as a remedy to promote sleep and help the muscles relax (Ulbricht, 2005). However, here are a few research conducted over the years to prove that there are more benefits than just these.

**Anti-anxiety effects:** the major use of kava supplements was to promote sleep. However, some research proved that kava extracts could be used for treating anxiety disorders. Back in 2013, scientists' research was conducted where 75 people with anxiety disorders were treated with kava extract or a placebo drug (Christl, 2009). The timeframe for this research was around six weeks. In these six weeks, all the changes in all 75 people were observed and recorded (Sarris, 2013). After the completion of 6 weeks, the kava plant supplements have a significant effect on reducing the symptoms of stress and anxiety. Though the patients had slight short-term problems like headaches, none of the patients showed any liver problems (Foo, 1997). The other side effects that are usually seen while consuming the kava plant were not reported by the patients with an anxiety disorder (Sarris, 2012). The NIH research-backed studies prove that the kava plant's despite show mixed results but is very effective in the treatment of anxiety.

**Sleep-Promoting effects:** Kava has been traditionally used by people all around the world for promoting sleep. Kava plant extracts and their supplements have anxiolytic effects that help people to promote their sleep. The kava plant has been used as an alternative therapy for sleep disorders for a long time now (Wang, 2018). However, this claim that the kava plant can be used to cure or used as a treatment to treat sleep disorders is not proven. One of the





**Manish Yadav**

main reasons why people choose Kava for deep sleep is because it does not have any effect on restful REM sleep as a substitute for prescribed sleeping drugs kava can be used (Herberg, 2013). However, it is suggested by the doctors not to taken other prescription drugs as it makes have adverse side effects (Berry, 2019).

**How can you Kava plant for better health**

Kava supplements are available in the market, and you can even buy them online in the United States. Though countries like France, Canada, Great Britain, and Germany have stopped the usage of Kava in the countries, it does deny the fact that kava plants have many health benefits (Carmella, 2019). Traditionally, in the pacific region, the locals used to make a paste of the roots of the kava plant and mix it with water to consume it. There are many regions in the pacific islands and the northern parts of Australia that Kava is consumed in the form of tea. Many of the businesses there are also selling kava tea from stores. The kava drug comes in various forms in the market, but the most popular one is the liquid form. It is consumed while mixing it well with fruit drinks or juice (McElroy, 2019). Apart from these beverages, the extracts of the kava plant have also been used to prepare tablets and capsules. These are tables and capsules made from Kava available in powdered form. Several reports suggest consuming kava supplements or medicines from the extracts of the kava plant with a prescription from doctors. However, heavy usage can be harmful. The idea does for a person who is using Kava is 250 milligrams of Kava per day.

As there are many forms in which you can consume Kava, but here are the forms in which they are mostly available in the market

**Kava Tea:** Kava tea is one of the most commonly used methods to consume Kava if you are treating anxiety. Kava tea is abundantly available in the market and is relied upon by many people across the world. It is also one of the traditional methods to consume Kava. Along with treating anxiety, it also promotes relaxation and is often sold with other important herbs. It is consumed by brewing the tea powder in hot water (Toll, 2007). While buying kava teas, look for the "proprietary blends" in the ingredients section. This is suggested even by the experts as the consumer does not the amount of Kava he or she is consuming. Also, the kavalactone content should be found on the package of the kava tea ingredients.

**Kava Tincture or Liquid:** Other than tea, there are other ways in which you can consume Kava. The tincture or liquid form of Kava is sold in the market. The sizes in which they are sold range from 59 ml to 177 ml. It is recommended to mix it in juice (Moulds, 2003). It is not advised to drink it with alcohol, although the solution might taste like whiskey. The liquid form of Kava should be consumed in a very small quantity as the kavalactones present in the liquid is quite concentrated.

**Kava Capsules:** The last form in which Kava is available in the market is in capsule form. These capsules are also made from the powder of the kava plant's root (Stickel, 2003). Just like the other two forms, you should also check the content of kavalactones before taking the capsule. It is commended to consume Kava capsules only if they are prescribed by a doctor.

**Insomniac Relief with Kava**

Since Kava is used for promoting sleep, the question that arises that, can Kava be used for patients suffering from insomnia? Kava helps the body to calm down, and a part of that process is by getting sufficient body sleep (Johnson, 2011). People have been using this Pacific herb, Kava, for better sleep at night and those who are struggling with insomnia.

**Why does Kava use it as a sleeping aid?**

Kavalactones are found in kava plants, and these plants are quite rich in them. Kavalactones showcase sedative nature, so they can be used for promoting sleep. This has not only been effective for humans but also animals. In the year 2005, while experimenting with Kava, it was studied that Kava can help maintain a sleep cycle for rats (Cloutre, 2004). However, it does not maintain the sleep cycle but helps the animals to fall asleep faster. This study was





### Manish Yadav

published in the journal Psychopharmacology in the year 2005. Clinical trials were conducted in the year 2005. In those trials, people suffering from sleep disturbances, anxiety, or stress were chosen. Sixty-one people were diagnosed with either Kava or placebo for a time frame of 4 weeks. In those four weeks, the people treated with Kava showed significant improvement steps in the quality of sleep compared to those who were treated with a placebo. Before that, Kava was used as a significant remedy for relieving stress. This was again proved right by clinical trials conducted in the year 2001 (Tarbah, 2003). Twenty-four patients who were suffering from stress-induced insomnia were treated with Kava for a significant amount of time for six weeks. The reports found that the patients' severity of stress was reduced, and improved quality of sleep was observed (Shaik, 2009). Though the researches show that Kava improves the quality of sleep, in the year 2005, it was observed that Kava could not be a reliable treatment for treating insomnia. In those trials, people were treated with Kava, placebo, and valerian. Placebo showed exciting, effective results as compared to Kava and valerian.

#### Caveats for using Kava as a sleeping aid

Many major countries in the world have rules against the use of kava plants. Even the National Institute of Health has issued a warning stating that herb can trigger and cause liver damage (Narayanpillai, 2014). The prolonged and heavy usage can even lead to death. However, there are a few other side effects that are seen in patients who are regularly using kava remedies for sleeping aid like jaundice (where the skin and eyes turn yellow), fatigue, and Dark urine. Other side effects that are observed are indigestion, headaches, drowsiness, etc.

#### Problems that Kava can cause if used for long term

Kava tea is quite popular amongst people. There are a few people who are now used to taking Kava as medicine for treating their anxiety (Weiss, 2005). Kava has proved to have a low withdrawal risk. Meaning, if a person is using Kava for a long time, he will show very few withdrawal symptoms when the person suddenly stops the usage. Though there is no proven proof of the point, the sudden stoppage in the usage does not seem to affect the person (Schmidt, 2003). However, whenever Kava is used as medicine, then medical supervision from the Doctor is recommended. Though the kava plant might show low withdrawal risk, there can be some serious long-term effects of Kava (Peterson, 2020). There can be problems that vary from breathing to other serious chronic diseases. Here are the long-term problems that can be caused by consumption regularly:

**Breathing Difficulties:** People who have been using Kava for a long period have been suffering from breathing difficulties. These problems are quite rare and might have various reasons for the cause.

**Sensitivity to light:** Another surprising problem that people who are using Kava for an extended period is that the users have developed some sort of phobia towards the light.

**Alteration in blood cells:** When consuming various drugs for a long time then it might alter the human blood cells. A similar case is seen with people using Kava for a long period (Bachhuber, 2016).

**Weight loss:** The regular and long-term usage of Kava can be a problem as people have shown signs of appetite loss, malnutrition, etc.

**Schizophrenia:** The regular and long-term use of kava plants can lead to worsening of the situation of pre-existing mental illness. Schizophrenia is one of the cases, and the symptoms can get very serious.

**Compromised immune system:** Due to the long-term use of Kava, the immune system might be compromised due to various reasons. The kava plant might sometimes act as a catalyst (Kessler, 2005).

**Contact dermatitis:** The skin might show some problems that can be caused due to regular use of Kava. The skin might turn yellow, can get a flaky rash on the skin, and may turn scaly.

#### Why it is important to use Doctor's advice before using Kava

The kava plant has many benefits and has proven itself many times. It has been traditionally used by locals and people all around the world as a healthy beverage. However, the kava plant has shown some side effects that, if ignored, can prove to be fatal (Dai, 2015). There are very few short-term effects that are shown. Despite being rare in short-term use, there are many instances where a doctor's advice is recommended as it can lead to worsening of the



**Manish Yadav**

situation. The kava plant is used mostly to promote sleep. The compounds present in the kava plant have relaxing and calming effects on the body. As sleeping pills are not recommended by doctors, the kava plant used for the promotion of sleep is also not recommended. However, it is not due to the nature of the plant but the addictive effects of the drug. Though the kava plant is not addictive, the drugs made from it might be (Jhoo, 2006). Apart from the promotion of sleep, the kava plant is also used to treat anxiety. Anxiety has been the major concern of people all around the world. The mental health issues are increasing daily, and the kava plant has shown positive results in treating patients with anxiety (Ketola, 2015). The plant possesses unique properties, which makes it a perfect remedy to relieve stress and anxiety. As the kava plant has many uses, it also has some of the side effects that one should be aware of. Here are a few side effects that a person consuming the kava plant might show, and once shown, the person seeks medical help immediately (Li, 2014).

**Loss of appetite:** People who are consuming the extracts of the kava plant have suffered this. The loss of appetite also leads to weight loss in the patient. If symptoms like these are ignored for a long period, then the situation can get fatal.

**Fatigue:** Extreme tiredness is one of the symptoms that users using Kava for a longer time experience. It is often due to the dizziness and calming effects that the kava plant has.

**Raised body temperature:** Body temperature is extremely important to maintain the normal functioning of the body (Pan, 2020). The rise in body temperature gradually is not noticed, but once the temperature rises, it can pose a lot of health-related issues. If the person using notices a temperature rise, then he or she must consult a doctor.

**Nausea and vomiting:** Kava plant does not mix well with alcohol and many other things. Nausea and vomiting are usually indications of such things. However, due to the components present in the plant or due to the heavy usage of kava dose, nausea and vomiting can be seen (Zhongbo, 2017). Consulting a doctor is recommended as soon as the patient feels unwell due to this.

**Brown coloured urine:** The change in color of urine is another issue that kava plant consumers have to face. This is a clear indication of something being wrong, and consulting a doctor should be done as soon as possible. This coloring of urine indicates that the kidney has been affected.

**Abdominal pains:** Abdominal pains are normal in the users consuming kava supplements. However, severe abdominal pains can cause serious problems and can lead to other things.

**Jaundice:** The regular use of Kava can lead to jaundice. In jaundice, the eyes and skin of the person turn yellow or pale yellow (Wruck, 2008). Kava plant sometimes triggers the reaction and cause severe pain. There are cases where the person suffering from jaundice has undergone severe pain and closing a fatal situation.

**Unusual bruises or bleeding:** Bruises and bleeding are not common in patients consuming kava supplements. Unusual bruises and bleeding can be a sign of serious injuries in the body. Even though the kava plant is useful, bleeding and bruises can be fatal.

The Doctor's prescription is needed before consumption of the kava plant is before of the side effects that the plant has. There are many side effects too, but there is even more concern that should be worrying the people. Kava supplements like tea, capsules, etc., are available in the market. The products, however, have may or may not have the contents used in them. Improper dosage can be worrying and prove to be deadly. Apart from that, kava plants have a whiskeys-like effect on the mind and body but do not go well with any form of alcohol. If consumed with alcohol, there might be many side effects. Even after precautions are maintained, things like medical history or mental illness can prove fatal while consuming the kava plant. One of the kava plant's effects is that it has caused depression when taken for a long time and in heavy quantity.

## CONCLUSION

The kava plant is grown in the south pacific and is found in the market in various forms like tea, supplements, etc. the effects of Kava depend on many factors like body size, immunity, etc. The kava plant has been used traditionally by northern Australians and south pacific islanders to relax muscles and relieve stress. Kava plants have many useful remedies for people suffering from anxiety, sleeplessness, etc. This can be one of the main reasons why this





### Manish Yadav

traditional herb was popular. Despite their useful nature, the plants show side effects that can prove fatal. That is the reason a doctor's prescription is needed. Though a few countries have banned or restricted the use of Kava in their countries but if consumed in limited and as per prescribed amount, then the kava plant can prove very helpful.

## REFERENCES

1. Fragoulis, A., Siegl, S., Fendt, M., Jansen, S., Soppa, U., Brandenburg, L.-O., Pufe, T., Weis, J., & Wruck, C. J. (2017). Oral administration of Methysticin improves cognitive deficits in a mouse model of Alzheimer's disease. *Redox Biology*, 12, 843–853.
2. Pollastri, M. P., Whitty, A., Merrill, J. C., Tang, X., Ashton, T. D., & Amar, S. (2009). Identification and Characterization of Kava-derived Compounds Mediating TNF- $\alpha$  Suppression. *Chemical Biology & Drug Design*, 74(2), 121–128.
3. Teschke, R., Sarris, J., Glass, X., & Schulze, J. (2011). Kava, the anxiolytic herb: back to basics to prevent liver injury? *British Journal of Clinical Pharmacology*, 71(3), 445–448.
4. R. Teschke, A. Genthner, & A. Wolff. (2021). *Kava hepatotoxicity: comparison of aqueous, ethanolic, acetonetic kava extracts and kava-herbs mixtures*.
5. R. Teschke, J. Sarris, & I. Schweitzer. (2012). *Kava hepatotoxicity in traditional and modern use: the presumed Pacific kava paradox hypothesis revisited*.
6. R. Teschke. (2012). *Kava hepatotoxicity--a clinical review*.
7. G. Petersen, Yijin Tang, & Fields, C. (2019). *Chemical and in vitro toxicity analysis of a supercritical fluid extract of Kava kava (Piper methysticum)*.
8. Tengfei Bian, Corral, P., Yuzhi Wang, Botello, J. F., Kingston, R., Daniels, T., R. Salloum, E. Johnston, Z. Huo, Lu, J., Liu, A. C., & C. Xing. (2020). *Kava as a Clinical Nutrient: Promises and Challenges*.
9. El-Kholy, S. M., & S. El-Salam. (2011). *Kava extract drug: what is the actual risk of Hepatotoxicity in adult male albino rats?*
10. K. Connor, J. Davidson, & L. Churchill. (2021). *Adverse-Effect Profile of Kava*.
11. Olsen, L. R., M. Grillo, & Skonberg, C. (2011). *Constituents in kava extracts potentially involved in Hepatotoxicity: a review*.
12. Chou, T.-W., Feng, J.-H., Huang, C.-C., Cheng, Y.-W., Chien, S.-C., Wang, S.-Y., & Shyur, L.-F. (2013). A Plant Kavalactone Desmethoxyyangonin Prevents Inflammation and Fulminant Hepatitis in Mice. *PLoS ONE*, 8(10).
13. Fasinu, P. S., Bouic, P. J., & Rosenkranz, B. (2012). An Overview of the Evidence and Mechanisms of Herb-Drug Interactions. *Frontiers in Pharmacology*, 3.
14. Kong, Y., Gao, X., Wang, C., Ning, C., Liu, K., Liu, Z., Sun, H., Ma, X., Sun, P., & Meng, Q. (2018). Protective effects of yangonin from an edible botanical Kava against lithocholic acid-induced cholestasis and Hepatotoxicity. *European Journal of Pharmacology*, 824, 64–71.
15. Lebot, V., Merlin, M., & Lindstrom, L. (1997). *Kava: The Pacific Elixir: The Definitive Guide to Its Ethnobotany, History, and Chemistry*.
16. Ulbricht, C., Basch, E., Boon, H., Ernst, E., Hammerness, P., Sollars, D., Tsourounis, C., Woods, J., & Bent, S. (2005). Safety review of Kava (Piper methysticum) by the Natural Standard Research Collaboration. *Expert Opinion on Drug Safety*, 4(4), 779–794.
17. Wruck, C. J., Götz, M. E., Herdegen, T., Varoga, D., Brandenburg, L.-O., & Pufe, T. (2008). Kavalactones protect neural cells against amyloid beta peptide-induced neurotoxicity via extracellular signal-regulated kinase 1/2-dependent nuclear factor erythroid 2-related factor 2 activation. *Molecular Pharmacology*, 73(6), 1785–1795.
18. Pan, H., Liu, F., Wang, J., Zhao, M., Wang, D., Jia, C., Wang, T., Chen, Z., Fan, Y., Liang, D., & Meng, Q. (2020). Dihydromethysticin, a natural molecule from Kava, suppresses the growth of colorectal cancer via the NLR3/PI3K pathway. *Molecular Carcinogenesis*, 59(6), 575–589.
19. Zhongbo, L., U-Syn, H., Ke, Y., Chunli, W., Noriko, Y., & Xiaolin, Z. (2017). Kavalactone yangonin induces autophagy and sensitizes bladder cancer cells to flavokawain A and docetaxel via inhibition of the mTOR pathway. *The Journal of Biomedical Research*, 31(5), 408.



**Manish Yadav**

20. Weiss, J., Sauer, A., Frank, A., & Unger, M. (2005). Extracts and kavalactones of piper methysticum g. Forst (kava-kava) inhibit p-glycoprotein in vitro. *Drug Metabolism and Disposition*, 33(11), 1580–1583.
21. TARBAH, F., MAHLER, H., KARDEL, B., WEINMANN, W., HAFNER, D., & DALDRUP, T. (2003). Kinetics of kavain and its metabolites after oral application. *Journal of Chromatography B*, 789(1), 115–130.
22. Shaik, A. A., Hermanson, D. L., & Xing, C. (2009). Identification of Methysticin as a potent and non-toxic NF- $\kappa$ B inhibitor from Kava, potentially responsible for Kava's chemopreventive activity. *Bioorganic & Medicinal Chemistry Letters*, 19(19), 5732–5736. <https://doi.org/10.1016/j.bmcl.2009.08.003>
23. Narayanapillai, S. C., Leitzman, P., O'Sullivan, M. G., & Xing, C. (2014). Flavokawains A and B in Kava, Not Dihydromethysticin, Potentiate Acetaminophen-Induced Hepatotoxicity in C57BL/6 Mice. *Chemical Research in Toxicology*, 27(10), 1871–1876. <https://doi.org/10.1021/tx5003194>
24. Schmidt, M. (2003). Are Kavalactones the Hepatotoxic Principle of Kava Extracts? The Pitfalls of the Glutathione Theory. *The Journal of Alternative and Complementary Medicine*, 9(2), 183–187. <https://doi.org/10.1089/10755530360623284>
25. Peterson, L. A., Balbo, S., Fujioka, N., Hatsukami, D. K., Hecht, S. S., Murphy, S. E., Stepanov, I., Tretyakova, N. Y., Turesky, R. J., & Villalta, P. W. (2020). Applying Tobacco, Environmental, and Dietary-Related Biomarkers to Understand Cancer Etiology and Evaluate Prevention Strategies. *Cancer Epidemiology Biomarkers & Prevention*, 29(10), 1904–1919. <https://doi.org/10.1158/1055-9965.epi-19-1356>
26. Moulds, R. F. W., & Malani, J. (2003). Kava: herbal panacea or liver poison? *Medical Journal of Australia*, 178(9), 451–453. <https://doi.org/10.5694/j.1326-5377.2003.tb05289.x>
27. Kava Hepatotoxicity: Are we any Closer to the Truth? (2004). *Planta Medica*, 70(3), 193–196. <https://doi.org/10.1055/s-2004-815533>
28. Johnson, T. E., Hermanson, D., Wang, L., Kassie, F., Upadhyaya, P., O'Sullivan, M. G., Hecht, S. S., Lu, J., & Xing, C. (2011). Lung Tumorigenesis Suppressing Effects of a Commercial Kava Extract and Its Selected Compounds in A/J Mice. *The American Journal of Chinese Medicine*, 39(04), 727–742. <https://doi.org/10.1142/s0192415x11009202>
29. Stickele, F., Baumüller, H.-M., Seitz, K., Vasilakis, D., Seitz, G., Seitz, H. K., & Schuppan, D. (2003). Hepatitis induced by Kava (Piper methysticum rhizoma). *Journal of Hepatology*, 39(1), 62–67. [https://doi.org/10.1016/s0168-8278\(03\)00175-2](https://doi.org/10.1016/s0168-8278(03)00175-2)
30. Toxicology and carcinogenesis studies of kava kava extract (CAS No. 9000-38-8) in F344/N rats and B6C3F1 mice (Gavage Studies). (2012). *National Toxicology Program Technical Report Series*, 571. <https://doi.org/>
31. McElroy, J. P., Carmella, S. G., Heskin, A. K., Tang, M. K., Murphy, S. E., Reisinger, S. A., Jensen, J. A., Hatsukami, D. K., Hecht, S. S., & Shields, P. G. (2019). Effects of cessation of cigarette smoking on eicosanoid biomarkers of inflammation and oxidative damage. *PLOS ONE*, 14(6), e0218386. <https://doi.org/10.1371/journal.pone.0218386>
32. Toll, B. A., O'Malley, S. S., McKee, S. A., Salovey, P., & Krishnan-Sarin, S. (2007). Confirmatory factor analysis of the Minnesota Nicotine Withdrawal Scale. *Psychology of Addictive Behaviors*, 21(2), 216–225. <https://doi.org/10.1037/0893-164x.21.2.216>
33. Carmella, S. G., Heskin, A. K., Tang, M. K., Jensen, J., Luo, X., Le, C. T., Murphy, S. E., Benowitz, N. L., McClernon, F. J., Vandrey, R., Allen, S. S., Denlinger-Apte, R., Cinciripini, P. M., Strasser, A. A., al'Absi, M., Robinson, J. D., Donny, E. C., Hatsukami, D. K., & Hecht, S. S. (2019). Longitudinal stability in cigarette smokers of urinary eicosanoid biomarkers of oxidative damage and inflammation. *PLOS ONE*, 14(4), e0215853. <https://doi.org/10.1371/journal.pone.0215853>
34. Cloutre, D. L. (2004). Kava kava: examining new reports of toxicity. *Toxicology Letters*, 150(1), 85–96. <https://doi.org/10.1016/j.toxlet.2003.07.005>
35. Kessler, R. C., Chiu, W. T., Demler, O., & Walters, E. E. (2005). Prevalence, Severity, and Comorbidity of 12-Month DSM-IV Disorders in the National Comorbidity Survey Replication. *Archives of General Psychiatry*, 62(6), 617. <https://doi.org/10.1001/archpsyc.62.6.617>
36. Bachhuber, M. A., Hennessy, S., Cunningham, C. O., & Starrels, J. L. (2016). Increasing Benzodiazepine Prescriptions and Overdose Mortality in the United States, 1996–2013. *American Journal of Public Health*, 106(4), 686–688. <https://doi.org/10.2105/ajph.2016.303061>



**Manish Yadav**

37. Fluyau, D., Revadigar, N., & Manobianco, B. E. (2018). Challenges of the pharmacological management of benzodiazepine withdrawal, dependence, and discontinuation. *Therapeutic Advances in Psychopharmacology*, 8(5), 147–168. <https://doi.org/10.1177/2045125317753340>
38. Sarris, J., Scholey, A., Schweitzer, I., Bousman, C., LaPorte, E., Ng, C., Murray, G., & Stough, C. (2012). The acute effects of Kava and oxazepam on anxiety, mood, neurocognition; and genetic correlates: a randomized, placebo-controlled, double-blind study. *Human Psychopharmacology: Clinical and Experimental*, 27(3), 262–269. <https://doi.org/10.1002/hup.2216>
39. Wang, Y., Eans, S. O., Stacy, H. M., Narayanapillai, S. C., Sharma, A., Fujioka, N., Haddad, L., McLaughlin, J., Avery, B. A., & Xing, C. (2018). A stable isotope dilution tandem mass spectrometry method of major kavalactones and its applications. *PLOS ONE*, 13(5), e0197940. <https://doi.org/10.1371/journal.pone.0197940>
40. Berry, J., Gilbert, A., & Grodnitzky, J. (2019). Cases of Kava Impairment in Iowa Drivers. *Journal of Forensic Sciences*, 64(6), 1943–1949. <https://doi.org/10.1111/1556-4029.14130>
41. Herberg KW. (2013). [Effect of Kava-Special Extract WS 1490 combined with ethyl alcohol on safety-relevant performance parameters]. *Blutalkohol*, 30(2). <https://doi.org/>
42. Foo, H., & LEMON, J. (1997). Acute effects of Kava, alone or in combination with alcohol, on subjective measures of impairment and intoxication and on cognitive performance. *Drug and Alcohol Review*, 16(2), 147–155. <https://doi.org/10.1080/09595239700186441>
43. Sarris, J., LaPorte, E., Scholey, A., King, R., Pipingas, A., Schweitzer, I., & Stough, C. (2013). Does a Medicinal Dose of Kava Impair Driving? A Randomized, Placebo-Controlled, Double-Blind Study. *Traffic Injury Prevention*, 14(1), 13–17. <https://doi.org/10.1080/15389588.2012.682233>
44. Christl, S. U., Seifert, A., & Seeler, D. (2009). Toxic Hepatitis After Consumption of Traditional Kava Preparation. *Journal of Travel Medicine*, 16(1), 55–56. <https://doi.org/10.1111/j.1708-8305.2008.00259.x>
45. Ketola, R. A., Viinamäki, J., Rasanen, I., Pelander, A., & Goebeler, S. (2015). Fatal kavalactone intoxication by suicidal intravenous injection. *Forensic Science International*, 249, e7–e11. <https://doi.org/10.1016/j.forsciint.2015.01.032>
46. Jhoo, J.-W., Freeman, J. P., Heinze, T. M., Moody, J. D., Schnackenberg, L. K., Beger, R. D., Dragull, K., Tang, C.-S., & Ang, C. Y. W. (2006). In Vitro Cytotoxicity of Nonpolar Constituents from Different Parts of Kava Plant (*Piper methysticum*). *Journal of Agricultural and Food Chemistry*, 54(8), 3157–3162. <https://doi.org/10.1021/jf051853j>
47. Li, X., Xu, X., Ji, T., Liu, Z., Gu, M., Hoang, B. H., & Zi, X. (2014). Dietary feeding of flavokawain A, a Kava chalcone, exhibits a satisfactory safety profile and its association with enhancement of phase II enzymes in mice. *Toxicology Reports*, 1, 2–11. <https://doi.org/10.1016/j.toxrep.2014.02.002>
48. Dai, J.-Q., Huang, Y.-G., & He, A.-N. (2015). Dihydromethysticin kavalactone induces apoptosis in osteosarcoma cells through modulation of PI3K/Akt pathway, disruption of mitochondrial membrane potential and inducing cell cycle arrest. *International Journal of Clinical and Experimental Pathology*, 8(5), 4356–4366. <https://www.ncbi.nlm.nih.gov/pmc/articles/PMC4502999/>
49. Kava. (n.d.). Gaia Herbs. Retrieved August 6, 2021, from <https://www.gaiaherbs.com/blogs/herbs/kava>
50. Kava - Better Health Channel. (n.d.). [www.betterhealth.vic.gov.au](http://www.betterhealth.vic.gov.au). Retrieved August 6, 2021, from <https://www.betterhealth.vic.gov.au/health/healthyliving/kava#medicinal-uses-of-kava>
51. Kava | Michigan Medicine. (n.d.). [www.uofmhealth.org](http://www.uofmhealth.org). <https://www.uofmhealth.org/health-library/tn7356spe>
52. Kava Can Promote Healthy Sleep by Reducing Stress. (n.d.). Verywell Health. Retrieved August 6, 2021, from <https://www.verywellhealth.com/kava-for-insomnia-relief-89337>
53. Kava Kava: Benefits, Side Effects and Dosage. (2018, February 10). Healthline.
54. Teschke, R., Sarris, J., & Schweitzer, I. (2012). Kava hepatotoxicity in traditional and modern use: the presumed Pacific kava paradox hypothesis revisited. *British Journal of Clinical Pharmacology*, 73(2), 170–174.
55. Dai, J.-Q., Huang, Y.-G., & He, A.-N. (2015). Dihydromethysticin kavalactone induces apoptosis in osteosarcoma cells through modulation of PI3K/Akt pathway, disruption of mitochondrial membrane potential and inducing cell cycle arrest. *International Journal of Clinical and Experimental Pathology*, 8(5), 4356–4366.
56. Petersen, G. E., Tang, Y., & Fields, C. (2019). Chemical and in vitro toxicity analysis of a supercritical fluid extract of Kava kava (*Piper methysticum*). *Journal of Ethnopharmacology*, 235, 301–308.

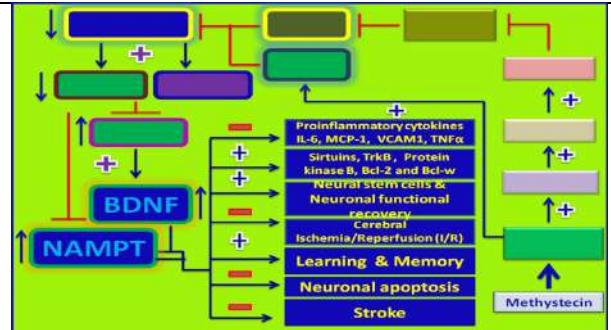




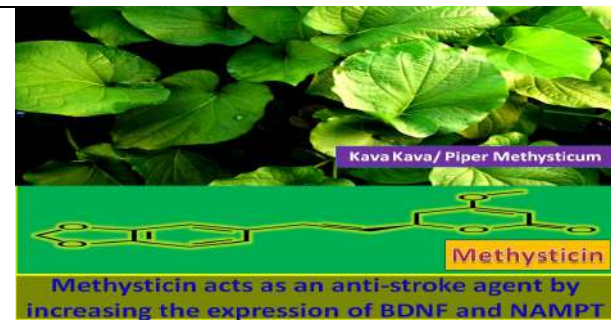
**Manish Yadav**



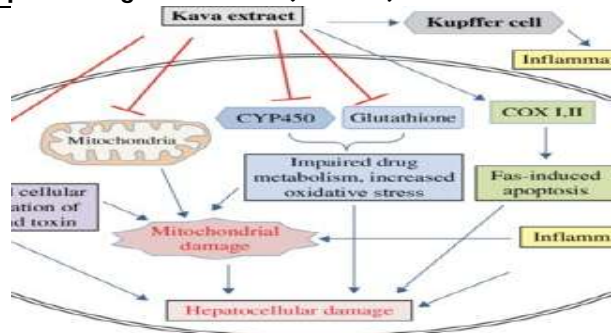
**Fig 1: Kava Plant (Foster et al.)**



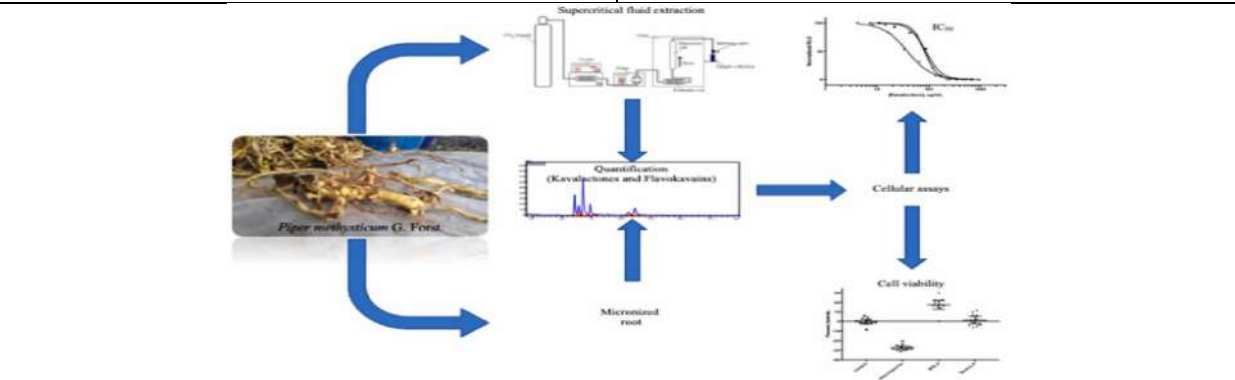
**Fig 2: Mechanistic insights into how Methysticin protects against stroke. (Bhoomi)**



**Fig 3: Kava Plant as Anti-stroke agent (Bhoomi)**



**Fig 4: Hepatotoxicity in Kava plant**



**Fig 5: Supercritical fluid extract of Kava (Peterson, 2019)**

Kava Root is one of the most useful supplements on the market, as it can help almost any physical ailment. It is a perennial plant native to the Pacific Island region, that has been used as ceremonial and medicinal herb for centuries. Kava kava is a shrub of the pepper family.

Kava herb is used for its relaxing and calming effects. It is used for treating Anxiety disorders, phobias, Stress-related anxiety, Insomnia, restlessness, jet-lag.

It is used to treat menstrual discomfort, menstrual disease, urinary problems, as anti-inflammatory agent against gout, rheumatism and bronchial congestion, muscular pain, cramping, stiffness.

Kava has analgesic and anti-inflammatory effects that it is used as pain killer to treat headache, fever, chronic fatigue syndrome and migraines.

It is also used as mouth wash for canker sores and toothache.

This herb is also applied to the skin to treat leprosy, to promote wound healing and to treat tuberculosis.

Kava is used to treat ADHD, epilepsy, psychosis and sleep related health problems.

**Fig 6: Health Benefits of Kava**





Manish Yadav



Fig 7: Use of Kava as a sleeping agent (Tara Moore)

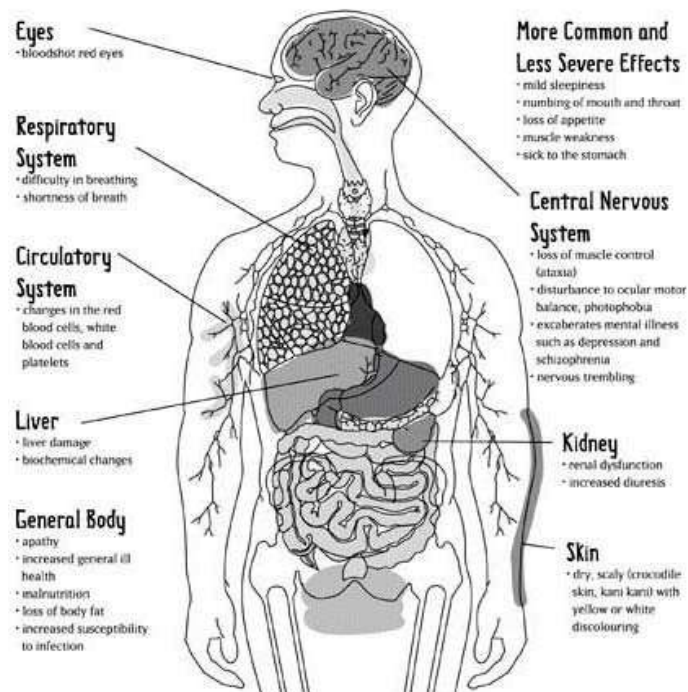


Fig 8: Side effects of Kava (Robson, 2005)







## Plant-Based AChE Inhibitors as Anti-Amnestic Agents - An Overview

Haritha P H<sup>1</sup>, V. Pavithra<sup>2</sup>, T. Lakshmi Narayanan<sup>3</sup>, Kondaveeti sreenivasulu<sup>3</sup> and Dithu Thekkekkara<sup>4\*</sup>

<sup>1</sup>M. Pharm, Dept. of Pharmacology, KMCH College of Pharmacy, Coimbatore, Tamil Nadu, India.

<sup>2</sup>Lecturer, Dept. of Pharmacology, KMCH College of Pharmacy, Coimbatore, Tamil Nadu, India.

<sup>3</sup>M. Pharm, Dept. of Pharmacology, JSS College of Pharmacy, Mysuru, Karnataka, India.

<sup>4</sup>Lecturer, Dept. of Pharmacology, JSS College of Pharmacy, Mysuru, Karnataka, India.

Received: 20 Nov 2021

Revised: 26 Dec 2021

Accepted: 13 Jan 2022

### \*Address for Correspondence

#### Dithu Thekkekkara

Lecturer, Dept. of Pharmacology,

JSS College of Pharmacy,

Mysuru, Karnataka, India.

Email: dithuthekkekkara@jssuni.edu.in



This is an Open Access Journal / article distributed under the terms of the **Creative Commons Attribution License** (CC BY-NC-ND 3.0) which permits unrestricted use, distribution, and reproduction in any medium, provided the original work is properly cited. All rights reserved.

### ABSTRACT

Generally, the common form of dementia is associated with Alzheimer's Disease (AD). AD can therapeutically deal with the inhibition of the Acetylcholinesterase enzyme (AChE). AChE works by the breakdown of ACh at cholinergic synapses on both central and peripheral nervous systems. As a result, inhibitors of AChE function help to increase the concentration and duration of action of Ach. Since synthetic drugs have more side effects, the search for unique AChE inhibitors especially from plants with fewer side effects has a great interest. In addition to AChE inhibitory potential, many of the phytochemicals possess additional anti-inflammatory and anti-oxidant activity which will help to prevent the progression of neurodegeneration, especially in AD. So, the present review article focuses on the overall picture of various plant extracts/phytoconstituents which possess AChE inhibitory activity and concluded that these plants can be used to develop new drugs for treating cognitive memory impairment.

**Keywords:** Dementia, AD, AChE inhibitors, Phytochemicals and Memory

### INTRODUCTION

Memory is defined as the ability to reproduce or remember experienced or learned content (1). Episodic memory impairment can lead to poor functional outcome, social adaptation, and quality of life (2). The major pathological reasons for this kind of disorders are mainly, damage to neuronal biomolecules through various inflammatory mechanisms including reactive microglia growth and iron buildup in a particular brain area (3) results in neuronal degeneration. World Health Organization (WHO) proposes dementia is a combination of deficiencies affecting memory, thinking, calculation, learning capacity, judgment, language, and emotional status. WHO reported



**Haritha et al.,**

2001, globally, 25% of individuals experience mental/neurological problems at a certain stage of life(4). Developed countries treat these diseases mainly with allopathic algorithms. However, in emerging and underdeveloped countries, a part of the victims, especially originating in urban areas, depending on the traditional herbal medicines. Since the use of the herbal medicines for neurological disorders has been concerned, scientific validation of medicinal plants supports their traditional uses and these evidence leads to the development of newer drugs (Sheng-Jia, 2001)(6). So, the present review article focuses on the overall picture of various plant extracts/phytoconstituents which possess AChE inhibitory activity and concluded that these plants can be used to develop potential candidates for treating Dementia. (Figure:1)

## Various Reasons for Dementia

### AD

AD is the common form of dementia (7) in geriatrics, either on its own or with other forms of pathology. It was first described over 100 years before, by German psychiatrist, Alois Alzheimer and disease is named after him(8)(9). AD affects 10% of the world's population over the age of 65(10). In early stage of AD neuronal damage occurs in the hippocampus and the depositions of intracellular neurofibrillary tangle(11) and extracellular amyloid plaques (12) are the cardinal markers of it. These abnormal plaques and tangles interfere with the normal functioning of brain cells (13). The disease is more noticeable over the microvasculature, where vessels started thinner and irregular, with numerous irregularly looped veins and string vessels appearing. In AD patients, stereological examinations reveal a decrease in hippocampus microvasculature, followed by hippocampal atrophy (14). In AD, pathological alterations like thickening of the capillary basement membrane and collagen buildup in the basement membrane have been seen.(15). The decrease of Acetylcholine(Ach) levels in the hippocampus and cortex is the major biochemical alteration in AD patients.(10). Ach is essential for cognitive performances. Hence, it's said that in AD, the cholinergic system is severely impacted.(16). Senile plaques and neurofibrillary tangles have been regarded as the pathological markers of AD. The principle molecular elements of these lesions include amyloid beta and tau. They have played a key role in both disease diagnosis and pathogenesis studies.(17). Plaques and tangles can be detected in several parts of the brain in Alzheimer's patients, including the amygdala, hippocampus, entorhinal cortex and basal forebrain(18). This causes progressive and irreversible impairment of cognitive function, resulting mainly in a loss of memory, with neurological and neuropsychiatric disorders (19). Brain ageing maybe associated with severe loss of neurons, decreased Ach level, increased oxidative stress and inflammation(20). This results in cognitive impairment, as well as reduced ability to respond to intellectual stimuli(21). Free radicals are the major principle agents responsible for causing cell alterations in disorders like AD(22). Many studies shows that in AD, brain is under elevated oxidative stress in, which leads to neuronal death and degeneration. There are many assisting evidence for the elevated oxidative stress in AD brain such as increased brain iron, aluminum, and mercury. Also, increased 4-hydroxynonenal, an aldehyde results of lipid peroxidation in AD ventricular fluid, AGE, heme oxygenase-1, SOD-1 in senile plaques, impaired energy metabolism and decline in cytochrome C oxidase in AD brain, various study reported that amyloid beta peptide has the ability to produce free radicals.(23).

### Vascular dementia

Second common form of dementia after AD is vascular dementia. It develops when arterial disease compromises the brain's blood flow, resulting in diminished neuronal function and finally, brain cell death. Hypertension, hyperlipidemia, diabetes, smoking, diet and obesity can be the risk factors for VD. Diabetes causes an increased risk of dementia not only through vascular disease but also through the cerebral deposition of compounds derived from the hormone amylin (24). Vascular dementia may develop following a stroke (25).

### Parkinson disease

Dementia is a problem in patients with the late stages of Parkinson disease (PD) (26). Sometimes, there's a chance of cognitive impairment of lesser severity in patients with PD without dementia this is called mild cognitive impairment (MCI) or PD-MCI (Yarnall *et al.*, 2014; Caviness *et al.*, 2007). According to Alison J. Yarnall *et al.*, PD-MCI is common and it can correlate with lower cerebrospinal b-amyloid 1–42 and 1–40 levels (29).



**Haritha et al.,****Huntington's disease**

Huntington's disease (HD) is a neurodegenerative disorder, associated by neuropsychiatric disturbances, involuntary movements, and cognitive impairment(30). Previous studies reported that in individuals with HD, there appears to be a significant deterioration in recalling memory happens.(31).(32)(33)(34). Currently research is ongoing towards to unfold the mystery behind memory impairment associated with HD.(35).

**Diabetes mellitus**

Diabetes mellitus(DM) is a metabolic condition characterized by high blood glucose level(36). It can affect the nervous systems, causing both anatomical and functional alteration.(37). Moderate cognitive impairment has been reported in persons with DM.(38). According to Mehmet Tuzcu *et al.*, oxidative stress may have a key-role in DM related cognitive problems(39). DM individuals possessing cognitive issues are commonly shows atrophy of the hippocampal formation.(40). Joa'õ M. N. Duarte *et al.*, provides evidence that there is a deprivation of nerve terminal markers , in type 2 diabetic mice, which is related with memory deficit.(41).

**Hypertension**

Some reports claims in hypertensive patients there is a chance to develop AD. Daniela Carnevale *et al.*, demonstrated that the vascular-induced AD pathology is mediated through high blood pressure induced RAGE (Receptor for Advanced Glycation End products mechanism)(42). High blood pressure can result in white matter hyper intensities or lacunar brain infarctions, which can induce cognitive impairment or dementia(43). Previous study reported that high prevalence of neurofibrillary tangles and brain atrophy in hypertensive patients.(44).

**Brain injury**

A head injury can also lead to memory impairment such as the "post-concussion syndrome," which is characterized by poor memory, headache, and disturbances in attention and concentration (45). Most of the patients recover these symptoms within a few weeks, but some have severe impairments in memory and cognition that they require months to years to regain normal function. A substantial Traumatic brain injury frequently disrupts basic cognitive abilities such as sustaining attention in the midst of multiple and/or conflicting stimuli, gaining new knowledge about the environment for later recollection and focused and sustained attention, which results in serious functional disability (46).

**Diagnosis**

Working memory impairments can be detected in two ways. Initially by preliminary screening by use of suitable sub-tests of standardized ability tests. If required additional memory impairment test is done by using a specialized working memory test battery. Diagnosis of AD can be made in various ways. Since the AD involve cognitive impairment, it can be supported by non-specific MRI of brain atrophy. However, in case of geriatrics or illiterate patients with Mild Cognitive Impairments, this method has less utility for the diagnosis. In recently, it has been reported that the future risk of AD can be assessed by using delayed paragraph recall.(47). Another method includes the examination between the logical connection of bio-markers and the hippocampussize, which include tau protein, abnormally processed amyloid beta and 8,12-iso-iPF2-VI isoprostane (isoprostane) accumulation. These biomarker results are highly informative (48). (Table No: 1)

**Treatments**

AD can therapeutically deal with the inhibition of AChE. This inhibition helps to elevate the Ach amount in the synaptic cleft and hence result in improving the communication between nerve cells (18). The enzyme AChE is crucial in the metabolic breakdown of Ach at the cholinergic synapses. As a result, inhibitors of AChE helps to increase Ach concentration and duration of action in synaptic cleft.(51). In earlier days the treatment has been started with precursor therapy, which includes the use of lecithin or other products which will enhance the levels of choline, one of the precursors of acetylcholine (50). Donepezil, Rivastigmine, Tacrine and Galantamine are the major drugs, which have been approved by the USFDA, to treat this disease (52). But, vomiting, diarrhea, nausea, weight loss,





Haritha et al.,

decreased appetite, muscle fatigue, muscle cramps, fatigue, dizziness and headache are the common side effects obtained for these drugs (Eumkeb, Sakdarat and Siriwong, 2010; Köse et al., 2015). However, presently there is no potential drug candidate for the treatment of AD. As a result, novel AChE inhibitors, especially from plants with fewer side effects has a great interest (50).

### Importance of Plants

Universe is a abundant source of biological diversity. Several plants were used in traditional medicine especially in Thailand for the treatment of memory impairment which is known as "rejuvenating" and "neurotonic" agents (55).Based on traditional knowledge, various plant species have yielded a vast number of natural bioactive chemicals. For example, *Ginkgo biloba* has been primarily discerned to enhance memory impairment and proved as an anti-ageing agent, it was later discovered that it had an impact on the treatment of mild to moderate AD.(56).Similarly, galanthamine, obtained from *Galanthus nivalis* is used for the treatment of AD. Galanthamine has been shown to raise Ach levels in synapsis by blocking the AChE. Around the world regions such as in Africa, Europe, America and Asia, have been screened the various plants, based on the family similarity phylogenetic analysis, or the constituents present in the plants. Some of the most recently studied plants having the inhibitory activities against AChE enzyme which can be used for the treatment of dementia based on their regional distribution are given below (Table No: 2).

### The Key Players of Anti Dementing Effect of Plants

Phytochemicals such as flavonoids, saponins, terpenoids can help in the treatment of memory impairment. Researches have been employing a variety of substances, frequently sourced from the environment (e.g. plant species), known as nutraceuticals, to better understand physiological and pathological cognitive function.(86). Many plant-derived secondary metabolite phytochemicals have been shown to improve subjective alertness and cognitive performance. Examples of these phytochemicals include —phenolics, terpenes, and alkaloids—differ in connection with plant's ecological roles, toxicity, and the amount to which they have direct impacts on brain function. (87).The various neuroprotective molecular mechanisms associated with phytochemicals explained in (Figure 2)

### Flavonoids

Flavonoids are the phytochemicals, which chemically derived from the phenyl benzopyrone nucleus. They're found abundantly in vegetables, nuts, seeds, flowers, stems and tea. It is a significant ingredient in the human diet (88). Flavonoids affects the central nervous system to produce sedation and analgesic properties (89). It shows advantageous effects on memory and prevent loss of cognition in relation to age-related dementia and AD (Xiao et al., 2010; Bate, Tayebi and Williams, 2008). The potential of flavonoids to cross the Blood Brain Barrier depends upon the lipophilicity of the compounds(92). The plant *Ginkgo biloba* is considered as the major source of triterpenoids and flavonoids mainly quercetin, which is used for the treatment of dementia. It's neuroprotective effect mainly contributed by ginkgolides A and B and bilobalide (Xiao et al., 2010; Levi-Montalcini et al., 1996; Chan et al., 2018). In the case of Ginkgolide B there is an increase in Nerve Growth Factor(NGF).(95). NGF improves the survival and maintenance of neurons generated from the neural crest, as well as cholinergic neurons of the basal forebrain, by inducing neurite outgrowth and promoting neurite outgrowth.(91). According to Gallant K. L. Chan, Quercetin enhances the effects of NGF in Cultured PC 12 Cells, as evidenced by Herbo Chips that indicate NGF binding.(96). Neurogenesis and synaptogenesis effect of *Ginkgo biloba* is explained by the presence of bilobalide and quercetin (97). Platelet Activating Factor (PAF) receptor antagonist effect of ginkgolides A and B (98). Even though PAF is required for synapse formation maintenance, the higher concentration of PAF produces deleterious effects. Also, quercetin, bilobalide, and ginkgolides A, B, and C have vasodilatory actions. (99).

**Quercetin:** *Malus domestica*(Apples),*Apis mellifera*( honey), *Rubus idaeus* (raspberries),*Allium cepa* ( onions) ,*Vitis vinifera* (red grapes), *Prunus avium*(cherries), citrus fruits, and green leafy vegetables contains high amount of quercetin. (100). Among various vegetables or fruits onion have the highest amount of Quercetin. The colouration and type of onion bulb appears to be a deciding factor for quercetin levels. Quercetin has the ability to alter synaptic plasticity



**Haritha et al.,**

and potentiation. Additionally, they involve in stimulating neuronal regeneration and revascularization (101), free radical scavenging activity, suppressing neuroinflammation, shielding neurons from neurotoxins, and improving neuronal functions (102). They can also act as AChE inhibitors. Quercetin is a lipophilic compound hence it can easily cross the BBB (103). In the APP<sup>swe</sup>/PS1<sup>dE9</sup> transgenic mice model of AD, it stimulates AMP-activated protein kinase (AMPK) activity. It's been proposed that stimulation of AMPK is one of the processes through which quercetin helps people with cognitive problems. The activation of AMPK prevents the phosphorylation of tau protein, which facilitates tubulin polymerization within the cell, leading to the development of microtubule (104). Quercetin has also been reported for its ability to reduce inflammatory indicators, NF- $\kappa$ B p65 nuclear translocation, and the production of  $\alpha$ -amyloid converting enzyme 1, resulting in a decrease in A $\beta$  levels and deposits. (105).

**Silibinin:** Milk thistle of the species *Silybum marianum* is used to extract silibinin. (106). As a result of reduction in oxidative stress by silibinin in turn it reduces the inflammatory response in the hippocampus (107). When aged animals were treated with silibinin, there was a reduction in dopamine depletion with in striatum, which resulted in improved motor behavior, lower MDA levels, and higher GSH levels in the nervous system. All of these shows that silibinin has the potential to be a neuroprotective factor, avoiding one of the symptoms of neurodegenerative disorders. That is oxidative stress. In short, silibinin works primarily on inflammatory response, oxidative stress components, and neuronal death. Thus, act as a neuroprotective agent.

**Naringin:** The flavanone naringenin and the disaccharide neohesperidose combine to form naringin, which can be found in various plants such as grapefruits and citrus fruits.(108). It shows action in anxiety, depression, schizophrenia, and Alzheimer's disease, among other neurodevelopmental and neurodegenerative disorders. (Opinion, 2011; Jeong, Jung and Kim, 2015). Naringin has been found in studies to increase discrimination and recognition while reversing scopolamine-induced short-term episodic memory impairments. (111). Since naringin has been shown antioxidant activity, it's included in the list of food additives (112). It has also been recently reported that naringin shows anti- seizure activity (113). According to Gopinath et al., 2011, naringin has been found to protect neurons against 3-nitropropionic acid-induced neurotoxicity by reducing oxidative stress and altering inflammatory responses. (114). According to studies, naringin's antioxidant properties may be accountable for shielding mitochondrial dysfunction-related oxidative damage, potentially by improving the brain's natural defense capacity to resist oxidative stress caused by i.c.v-streptozocin. (115). (116)

**Rutin:** It has reported as one of the primary flavonoids among buckwheat, apricots, cherries, grapes, plums and oranges. (117). It has a wide range of pharmacological activities such as anti-inflammatory, antioxidant, anticarcinogenic, antiallergic and antiviral(118).In AD,rutin can improve memory impairment. And also it decrease hippocampal pyramidal neuronal degeneration. (119). According to H. Javed *et. al.*, In i.c.v-streptozocin infused rats, Rutin demonstrated considerable neuroprotection, which might be due to the suppression of behavioral deficits, inflammatory indicators, PARP activity, lipid peroxidation, and elevation of endogenous antioxidant status.(120). Rutin inhibits oxidative stress, mitochondrial malfunction, and cell death in Caco-2 cells.(Spencer, 2010; Shukitt-Hale, Cheng and Joseph, 2009).

**Anthocyanins:** Anthocyanins, member of flavonoid family, which are capable of giving colors to the flowers and fruits due to the presence of phenolic groups in their structures (123). And also, be the most beneficial of flavonoid in case of neuroprotection (124). For anthocyanins, there is a clear neuroprotective action (125) along with strong antioxidants and efficient scavengers of ROS and RNS, protection of susceptible neurons from inflammation, improved blood circulation to the brain, augmentation of current neuronal function, and neurogenesis initiation in cognition-related brain regions. According to Jessié M. Gutierrez *et. Al.*,sweet cherry juice contains high amount of anthocyanins given for 12 weeks has advantage for cognitive function in older adults with Alzheimer's-type dementia, suggesting that anthocyanins can revert back the hazardous effect of i.c.v induced streptozocin model. (126)





Haritha et al.,

### Saponins

Saponins are glycosides with one or more sugar chains on the backbone of a triterpene or steroid aglycone, also known as sapogenins. Saponins can be classified as mono, di-, or tridesmosidic, according to the sugar molecules attached to their structure. Saponins are the compounds that shows variety of biological effects like anti-oxidant, anti-inflammatory, and analgesic effect(127).

**Steroidal saponins:** It is a group of oligosaccharide glycosides derived from spirostane. They have shown the ability to improve and up-regulate the number of nicotinic receptors significantly, promote the proliferation of nerve cells, cerebral circulation and metabolism, and scavenge free radicals. They can be isolated from various plants such as *Dioscorea nipponica* Makino, *Dioscorea panthaica* Prain et Burk, *Allium sativum* L., *Anemarrhena asphode loides* Bge., *Paris polyphilla*, *Polygonatum Odoratum* (Mill) Drace, *Ophiopogon japonicus*, *Agave americana* L. and *Anemarrhena asphodeloides* Bunge (AA, family Liliaceae). AA includes xantones like mangiferin as well as steroidal saponins like timosaponin AIII and sarsasapogenin, and this saponin mixture helps to improve the cognition in amyloid  $\beta$ -peptide induced rats with dementia (128)

**Ginsenoside:** Ginseng, the root of *Panax ginseng*, is the most important plant source of saponin. In brain-damaged rats, they exhibit a considerable improvement in cognition.(129). Ginseng saponins Rb1 and Rg1 are the most important ginseng saponins, and they have been shown to increase spatial learning in normal mice.(130). Ginsenoside Rb1 also has an anti-neuroinflammatory effect (131). Its mechanism might be implicated in BKCa channel activation. (132). Previous research suggests that ginsenoside Rb1 therapy reduces hippocampal pyramidal cell injury.(133). In mice, the ginsenoside compound K, a metabolite of protopanaxadiol-type saponins generated by intestinal bacteria, showed considerable recovery from amnesia, axonal atrophy, and synaptic loss.(134).

**Xanthoceraside:** It is a triterpenoid saponin, which is isolated from the husks of *Xanthoceras sorbifolia* Bunge.Xanthoceraside has been shown in several studies to increase the number of hippocampus dendritic spines and improve spatial memory deficits. (Liu et al., 2013; Lin et al., 2012). Lin zhu et al. discovered that xanthoceraside reduces learning memory impairments and increases the nesting ability of APP/ PS1 transgenic mice in a dose-dependent manner. (137). According to the study of P. Liu et. Al, xanthoceraside might alleviate learning and memory impairments caused by i.c.v- streptozocin injections by activating the insulin signaling pathway. (138)

**Onjisaponin:** Onjisaponin , a major saponin found as the main constituent of herbal plant *Radix Polygalae* (RAPO), which exhibits nootropic activity (139). *Radix Polygalae* and its active components reported to improve cognitive impairment in old mice.(140). Onjisaponin B has the ability to trigger autophagy, which might have therapeutic implications in the treatment of neurodegeneration. (141). According to An-Guo Wu et. al., *Radix Polygalae* ethanol extracts and Onjisaponin B produced from those extracts protect against neurodegenerative disorders by boosting the clearance of overexpressed mutant proteins such A53T -synuclein and huntingtin with 74 CAG repeats and lowering -synuclein oligomerization in cells.

### Terpenoids

Terpenoids are plant-derived compounds, which possess significant anti-dementic activity. The major plants, which show terpenoid contents, are rhizomes of valerian and ginseng. The rhizome of valerian (*Valerian officinalis*) possesses two pharmacologically active compounds such as valepotriates and sesquiterpenes (valerianic acid and acetoxyvalerenic acid). The crude extract of valerian has GABA uptake inhibition and GABA (B) receptor binding properties in rat synaptosomes (142). Huperzine A, a sesquiterpene alkaloid purified from *Huperia serrata*, possess neuroprotective effect. Huperzine A increased spatial working memory and improved learning and memory deficits. (143). *Centella asiatica* L. contains triterpenoid, monoterpenes,  $\beta$ -pinene and  $\gamma$ -terpinene and they are active chemical substances, which can revitalize and strengthen the nervous function (144). Ginseng helps damaged or aging brains recover their learning abilities. Also, more studies prove that by stimulating the protein kinase A/cAMP response element-binding protein signaling pathway, ginsenoside Rg1 reduces accumulated A $\beta$  and enhances cognitive



**Haritha et al.,**

function in preclinical studies. (50). Ginsenoside Rg1 also helps to enhance cognitive function by lowering A $\beta$  production via altering the APP pathway. (Vishwakarma et al., 2015; Singh and Dhawan, 1982).

**Bacoposide**

Bacoposide derived from the *Bacopa monniera* Linn (BM) of the *Scrophulariaceae* family. (147). Brahmi extract includes triterpenoids, saponins, alkaloids, glycosides, and alcohols. The major constituents include bacoposide A and B with a variety of pharmacological effects. Bacoposide A is made up of a variety of saponins, including Bacoposide A3, bacoposide, jujubogenin, and bacoposaponin C. (148). Bacoposide has been suggested to be an efficient neuroprotective drug against oxidative stress-related neuronal degeneration in a number of studies. (149). Subhash Dwivedi et al., demonstrated the activation of Nrf2 and inhibiting NF- $\kappa$ B transcription factors by bacoposide strengthens endogenous defense and protect against OKA induced memory deficit in rats. According to Debnath et al., Lower dosages of brahmi extract administration have been observed to suppress interleukin and TNF levels in LPS-induced N9 microglial cells.

**CONCLUSION**

Because 25% of people suffer from mental/neurological problems at some point in their lives, it is important to improve the treatment for this disease as soon as possible. Using AChE inhibitors to increase acetylcholine levels in the brain is one of the most promising ways to cure this condition. There are several plants contain constituents such as flavonoids, saponins, terpenoids, having AChE inhibitory activity around the world. They are more potential candidates for treatment of Dementia with lesser side effects than synthetic drugs. So, from the current review article, it is concluded that, the plants/phytochemicals containing constituents that have AChE inhibitory activity can be used to develop the new drugs for treating cognitive memory impairment. Based on this review, it is clear that the phytochemicals is producing neuronal protection through various mechanisms like stimulation of AMPK pathway, inhibition of Nf- $\kappa$ B, production of amyloid converting enzyme, activation of Nrf2 and suppression of Interleukin, free radical scavenging potential and TNF  $\alpha$  levels along with AChE inhibitory action.

**Conflict of interest**

The Authors declare that there is no conflict of interest.

**REFERENCES**

1. Arlt S. Non-Alzheimer's disease—related memory impairment and dementia. *Dialogues Clin Neurosci* [Internet]. 2013 Dec [cited 2021 Oct 25];15(4):465. Available from: /pmc/articles/PMC3898684/
2. Green MF, Kern RS, Braff DL, Mintz J. Neurocognitive deficits and functional outcome in schizophrenia: Are we measuring the "right stuff"? *Schizophr Bull.* 2000;26(1):119–36.
3. Gerlach M, Double KL, Ben-Shachar D, Zecca L, Youdim MBH, Riederer P. Neuromelanin and its interaction with iron as a potential risk factor for dopaminergic neurodegeneration underlying Parkinson's disease. *Neurotox Res.* 2003;5(1–2):35–43.
4. Ort EP. The world health report 2001 — Mental health: new understanding, new hope. *Bull World Health Organ.* 2001;79(11):1085–1085.
5. Sheng-Ji P. Ethnobotanical approaches of traditional medicine studies: Some experiences from Asia. *Pharm Biol.* 2001;39(SUPPL.):74–9.
6. Ullah I, Subhan F, Ayaz M, Shah R, Ali G, Haq IU, et al. Anti-emetic mechanisms of zingiber officinale against cisplatin induced emesis in the pigeon; behavioral and neurochemical correlates. *BMC Complement Altern Med.* 2015 Feb 26;15(1).
7. Qiu C, Kivipelto M, Von Strauss E. Epidemiology of Alzheimer's disease: Occurrence, determinants, and strategies toward intervention. *Dialogues Clin Neurosci.* 2009;11(2):111–28.
8. Maurer K, Volk S, Gerbaldo H, Auguste D and Alzheimer's disease. *Lancet.* 1997;349(9064):1546–9.





**Haritha et al.,**

9. Orhan I, Aslan M. Appraisal of scopolamine-induced anti-amnesic effect in mice and in vitro antiacetylcholinesterase and antioxidant activities of some traditionally used Lamiaceae plants. *J Ethnopharmacol.* 2009;122(2):327–32.
10. Orhan I, Kartal M, Naz Q, Ejaz A, Yilmaz G, Kan Y, et al. Antioxidant and anticholinesterase evaluation of selected Turkish *Salvia* species. *Food Chem.* 2007;103(4):1247–54.
11. Price JL, Morris JC. <Price and Morris, 1999.pdf>. 1999;358–68.
12. Arriagada P V., Marzloff K, Hyman BT. Distribution of Alzheimer-type pathologic changes in nondemented elderly individuals matches the pattern in Alzheimer's disease. *Neurology.* 1992;42(9):1681–8.
13. Dening T, Sandilyan MB. Dementia: definitions and types. *Nurs Stand.* 2015;29(37):37–42.
14. Gama Sosa MA, De Gasperi R, Rocher AB, Wang ACJ, Janssen WGM, Flores T, et al. Age-related vascular pathology in transgenic mice expressing presenilin 1-associated familial Alzheimer's disease mutations. *Am J Pathol [Internet].* 2010;176(1):353–68. Available from: <http://dx.doi.org/10.2353/ajpath.2010.090482>
15. Farkas E, De Jong GI, De Vos RAI, Jansen Steur ENH, Luiten PGM. Pathological features of cerebral cortical capillaries are doubled in Alzheimer's disease and Parkinson's disease. *Acta Neuropathol.* 2000;100(4):395–402.
16. Yu QS, Holloway HW, Utsuki T, Brossi A, Greig NH. Synthesis of novel phenserine-based-selective inhibitors of butyrylcholinesterase for Alzheimer's disease. *J Med Chem.* 1999;42(10):1855–61.
17. Armstrong RA. The molecular biology of senile plaques and neurofibrillary tangles in Alzheimer's disease. *Folia Neuropathol.* 2009;47(4):289–99.
18. Mattson MP, Maudsley S, Martin B. A neural signaling triumvirate that influences ageing and age-related disease: Insulin/IGF-1, BDNF and serotonin. *Ageing Res Rev.* 2004;3(4):445–64.
19. Adewusi EA, Moodley N, Steenkamp V. Medicinal plants with cholinesterase inhibitory activity: A review. *African J Biotechnol.* 2010;9(49):8257–76.
20. Zhao YN, Li WF, Li F, Zhang Z, Dai YD, Xu AL, et al. Resveratrol improves learning and memory in normally aged mice through microRNA-CREB pathway. *Biochem Biophys Res Commun.* 2013;435(4):597–602.
21. Cantuti-Castelvetri I, Shukitt-Hale B, Joseph JA. Neurobehavioral aspects of antioxidants in aging. *Int J Dev Neurosci.* 2000;18(4–5):367–81.
22. Li J, Wuliji O, Li W, Jiang ZG, Ghanbari HA. Oxidative stress and neurodegenerative disorders. *Int J Mol Sci.* 2013;14(12):24438–75.
23. Markesbery WR. Oxidative stress hypothesis in Alzheimer's disease. *Free Radic Biol Med.* 1997;23(1):134–47.
24. Jackson K, Barisone GA, Diaz E, Jin LW, DeCarli C, Despa F. Amylin deposition in the brain: A second amyloid in Alzheimer disease? *Ann Neurol.* 2013;74(4):517–26.
25. Tatemichi TK, Paik M, Bagiella E, Desmond DW, Stern Y, Sano M, et al. Risk of dementia after stroke in a hospitalized cohort. *Neurology [Internet].* 1994 Oct 1;44(10):1885 LP – 1885. Available from: <http://n.neurology.org/content/44/10/1885.abstract>
26. Williams-Gray CH, Evans JR, Goris A, Foltynie T, Ban M, Robbins TW, et al. The distinct cognitive syndromes of Parkinson's disease: 5 year follow-up of the CamPaIGN cohort. *Brain.* 2009;132(11):2958–69.
27. Yarnall AJ, Breen DP, Duncan GW, Khoo TK, Coleman SY, Firkbank MJ, et al. Characterizing mild cognitive impairment in incident Parkinson disease: The ICICLE-PD Study. *Neurology.* 2014;82(4):308–16.
28. Caviness JN, Driver-Dunckley E, Connor DJ, Sabbagh MN, Hentz JG, Noble B, et al. Defining mild cognitive impairment in Parkinson's disease. *Mov Disord.* 2007;22(9):1272–7.
29. Cox C, Martin A, Chase T, Fedio P. Differential Perceptual-Spatial Impairment in Huntington's and Alzheimer's Dementias. 2015;4–7.
30. Beatty WW, Salmon DP, Butters N, Heindel WC, Granholm EL. Retrograde amnesia in patients with Alzheimer's disease or Huntington's disease. *Neurobiol Aging.* 1988;9(C):181–6.
31. Biessels GJ, Kappelle AC, Bravenboer B, Erkelens DW, Gispen WH. Cerebral function in diabetes mellitus. *Diabetologia [Internet].* 1994;37(7):643–50. Available from: <https://doi.org/10.1007/BF00417687>
32. Brandt J, Bylisma FW, Aylward EH, Rothlind J, Gow CA. Impaired Source Memory in Huntington's Disease and its Relation to Basal Ganglia Atrophy. *J Clin Exp Neuropsychol.* 1995;17(6):868–77.
33. Butters N, Sax D, Montgomery K, Tarlow S. Comparison of the Neuropsychological Deficits Associated With Early and Advanced Huntington's Disease. *Arch Neurol.* 1978;35(9):585–9.





**Haritha et al.,**

34. Zakzanis KK. The subcortical dementia of Huntington's disease. *J Clin Exp Neuropsychol.* 1998;20(4):565–78.
35. Gispen WH, Biessels GJ. Cognition and synaptic plasticity in diabetes mellitus. *Trends Neurosci.* 2000;23(11):542–9.
36. Reaven GM, Thompson LW, Nahum D, Haskins E. Relationship between hyperglycemia and cognitive function in older NIDDM patients. *Diabetes Care.* 1990;13(1):16–21.
37. Tuzcu M, Baydas G. Effect of melatonin and vitamin E on diabetes-induced learning and memory impairment in rats. *Eur J Pharmacol.* 2006;537(1–3):106–10.
38. Gold SM, Dziobek I, Sweat V, Tirsi A, Rogers K, Bruehl H, et al. Hippocampal damage and memory impairments as possible early brain complications of type 2 diabetes. *Diabetologia.* 2007;50(4):711–9.
39. Duarte JMN, Agostinho PM, Carvalho RA, Cunha RA. Caffeine consumption prevents diabetes-induced memory impairment and synaptotoxicity in the hippocampus of nonczno10/ltj mice. *PLoS One.* 2012;7(4):1–10.
40. Carnevale D, Mascio G, D'Andrea I, Fardella V, Bell RD, Branchi I, et al. Hypertension induces brain  $\beta$ -amyloid accumulation, cognitive impairment, and memory deterioration through activation of receptor for advanced glycation end products in brain vasculature. *Hypertension.* 2012;60(1):188–97.
41. Kalaria RN. The role of cerebral ischemia in Alzheimer's disease. *Neurobiol Aging.* 2000;21(2):321–30.
42. Sparks DL, Scheff SW, Liu H, Landers T, Danner F, Coyne CM, et al. Increased density of senile plaques (SP), but not neurofibrillary tangles (NFT), in non-demented individuals with the apolipoprotein E4 allele: Comparison to confirmed Alzheimer's disease patients. *J Neurol Sci.* 1996;138(1–2):97–104.
43. Korf ESC, White LR, Scheltens P, Launer LJ. Midlife blood pressure and the risk of hippocampal atrophy: The Honolulu Asia aging study. *Hypertension.* 2004;44(1):29–34.
44. Rao V, Lyketsos CG. Psychiatric aspects of traumatic brain injury. *Psychiatr Clin North Am.* 2002;25(1):43–69.
45. Soble JR, Critchfield EA, O'Rourke JF. Neuropsychological Evaluation in Traumatic Brain Injury. *Phys Med Rehabil Clin N Am* [Internet]. 2017;28(2):339–50. Available from: <http://dx.doi.org/10.1016/j.pmr.2016.12.009>
46. Gathercole SE, Alloway TP. Practitioner review: Short-term and working memory impairments in neurodevelopmental disorders: Diagnosis and remedial support. *J Child Psychol Psychiatry Allied Discip.* 2006;47(1):4–15.
47. Kluger A, Ferris SH, Golomb J, Mittelman MS, Reisberg B. Neuropsychological prediction of decline to dementia in nondemented elderly. *J Geriatr Psychiatry Neurol.* 1999;12(4):168–79.
48. Di Giovanni S, Borloz A, Urbain A, Marston A, Hostettmann K, Carrupt PA, et al. In vitro screening assays to identify natural or synthetic acetylcholinesterase inhibitors: Thin layer chromatography versus microplate methods. *Eur J Pharm Sci.* 2008;33(2):109–19.
49. Ingkaninan K, Temkitthawon P, Chuenchom K, Yuyaem T, Thongnoi W. Screening for acetylcholinesterase inhibitory activity in plants used in Thai traditional rejuvenating and neurotonic remedies. *J Ethnopharmacol.* 2003;89(2–3):261–4.
50. Singh H., Dhawan BN. NEUROPSYCHOPHARMACOLOGICAL EFFECTS OF THE AYURVEDIC NOOTROPIC. *Indian J Pharmacol.* 1997;29:S359–65.
51. Whitehouse PJ. Cholinergic therapy in dementia. *Acta Neurol Scand.* 1993;88(149 S):42–5.
52. Jiang L, Su L, Cui H, Ren J, Li C. Ginkgo biloba extract for dementia: a systematic review. *Shanghai Arch Psychiatry.* 2013;25(1):10–21.
53. Eumkeb G, Sakdarat S, Siriwong S. Reversing  $\beta$ -lactam antibiotic resistance of *Staphylococcus aureus* with galangin from *Alpinia officinarum* Hance and synergism with ceftazidime. *Phytomedicine* [Internet]. 2010;18(1):40–5. Available from: <http://dx.doi.org/10.1016/j.phymed.2010.09.003>
54. Köse LP, Gülçin I, Gören AC, Namiesnik J, Martinez-Ayala AL, Gorinstein S. LC-MS/MS analysis, antioxidant and anticholinergic properties of galanga (*Alpinia officinarum* Hance) rhizomes. *Ind Crops Prod.* 2015;74:712–21.
55. Shekhar C, Kumar S. Kinetics of Acetylcholinesterase Inhibition by an Aqueous Extract of *Mentha longifolia* Leaves. *Int J Pharm Sci Drug Res.* 2014;6(4):348–50.
56. Dalai MK, Bhadra S, Chaudhary SK, Chanda J, Bandyopadhyay A, Mukherjee PK. Anticholinesterase activity of *Cinnamomum zeylanicum* L. leaf extract. *Tang* [Humanitas Med. 2014;4(2):11.1-11.6.
57. Basri AM, Taha H, Ahmad N. A Review on the Pharmacological Activities and Phytochemicals of *Alpinia*



**Haritha et al.,**

- officinarum (Galanga) Extracts Derived from Bioassay-Guided Fractionation and Isolation. *Pharmacogn Rev* [Internet]. 2017;11(21):43–56. Available from: <https://pubmed.ncbi.nlm.nih.gov/28503054>
58. Mikaili P, Mojaverrostami S, Moloudizargari M, Aghajanshakeri S. Pharmacological and therapeutic effects of *Mentha Longifolia L.* and its main constituent, menthol. *Anc Sci Life* [Internet]. 2013 Oct;33(2):131–8. Available from: <https://pubmed.ncbi.nlm.nih.gov/25284948>
59. Cheenpracha S, Raksat A, Ritthiwigrom T, Laphookhieo S. Monoterpene indole alkaloids from the twigs of *kopsia arborea*. *Nat Prod Commun*. 2014;9(10):1441–3.
60. Kim JK, Kim CR, Lim HJ, Nam SH, Joo OS, Shin DH, et al. An optimized extraction technique for acetylcholinesterase inhibitors from the *Camellia japonica* seed cake by using response surface methodology. *Biosci Biotechnol Biochem*. 2014;78(7):1237–41.
61. Mandegary A, Soodi M, Sharififar F, Ahmadi S. Anticholinesterase, antioxidant, and neuroprotective effects of *Tripleurospermum disciforme* and *Dracocephalum multicaule*. *J Ayurveda Integr Med*. 2014;5(3):162–6.
62. Esmaili MA, Sonboli A, Mirjalili MH. Oxidative stress protective effect of *Dracocephalum multicaule* essential oil against human cancer cell line. *Nat Prod Res*. 2014;28(11):848–52.
63. Samling BA, Assim Z, Tong W-Y, Leong C-R, Ab Rashid S, Nik Mohamed Kamal NNS, et al. *Cynometra cauliflora L.*: An indigenous tropical fruit tree in Malaysia bearing essential oils and their biological activities. *Arab J Chem* [Internet]. 2021;14(9):103302. Available from: <https://www.sciencedirect.com/science/article/pii/S1878535221003178>
64. Dung HV, Cuong TD, Chinh NM, Quyen D, Kim JA, Byeon JS, et al. Compounds from the aerial parts of *Piper bavinum* and their anti-cholinesterase activity. *Arch Pharm Res*. 2015;38(5):677–82.
65. Mogana R, Adhikari A, Debnath S, Hazra S, Hazra B, Teng-Jin K, et al. The antiacetylcholinesterase and antileishmanial activities of *canarium patentinervium* Miq. *Biomed Res Int*. 2014;2014.
66. Krejčová P, Kučerová P, Stafford GI, Jäger AK, Kubec R. Antiinflammatory and neurological activity of pyriithione and related sulfur-containing pyridine N-oxides from Persian shallot (*Allium stipitatum*). *J Ethnopharmacol*. 2014;154(1):176–82.
67. Ma QY, Chen YC, Huang SZ, Guo ZK, Dai HF, Hua Y, et al. Two new guaiane sesquiterpenoids from *Daphne holosericea* (Diels) Hamaya. *Molecules*. 2014;19(9):14266–72.
68. Song CW, Lunga PK, Qin XJ, Cheng GG, Liu YP, Luo XD. Chemical Constituents from the Stems of *Ecdysanthera rosea*. *Nat Products Bioprospect*. 2014;4(6):319–23.
69. Tan WN, Khairuddean M, Wong KC, Khaw KY, Vikneswaran M. New cholinesterase inhibitors from *Garcinia atroviridis*. *Fitoterapia* [Internet]. 2014;97:261–7. Available from: <http://dx.doi.org/10.1016/j.fitote.2014.06.003>
70. Zhang DB, Chen JJ, Song QY, Zhang L, Gao K. Lycodine- Type alkaloids from *Lycopodium casuarinoides* and their acetylcholinesterase inhibitory activity. *Molecules*. 2014;19(7):9999–10010.
71. Chuong NN, Trung BH, Luan TC, Hung TM, Dang NH, Dat NT. Anti-amnesic effect of alkaloid fraction from *Lycopodiella cernua* (L.) Pic. Serm. on scopolamine-induced memory impairment in mice. *Neurosci Lett* [Internet]. 2014;575:42–6. Available from: <http://dx.doi.org/10.1016/j.neulet.2014.05.031>
72. Zhang J, Fan P, Zhu R, Li R, Lin Z, Sun B, et al. Marsupellins A-F, ent -longipinane-type sesquiterpenoids from the chinese liverwort *marsupella alpine* with acetylcholinesterase inhibitory activity. *J Nat Prod*. 2014;77(4):1031–6.
73. Ayaz M, Junaid M, Ahmed J, Ullah F, Sadiq A, Ahmad S, et al. Phenolic contents, antioxidant and anticholinesterase potentials of crude extract, subsequent fractions and crude saponins from *Polygonum hydropiper L.* *BMC Complement Altern Med*. 2014;14:1–9.
74. Kuanhut W, Aree T, Pornpakakul S, Sawasdee P. Novel cucurbitane triterpenoids and anti-cholinesterase activities of constituents from *Momordica charantia L.* *Nat Prod Commun*. 2014;9(6):765–9.
75. Ghosh K, Bhattacharya TK. Chemical constituents of *Piper betle* Linn. (Piperaceae) roots. *Molecules* [Internet]. 2005 Aug 31;10(7):798–802. Available from: <https://pubmed.ncbi.nlm.nih.gov/18007349>
76. Kiendrebeogo M, Coulibaly AY, Nebie RCH, Zeba B, Lamien CE, Lamien-Meda A, et al. Antiacetylcholinesterase and antioxidant activity of essential oils from six medicinal plants from Burkina Faso. *Rev Bras Farmacogn*. 2011;21(1):63–9.
77. Liew SY, Khaw KY, Murugaiyah V, Looi CY, Wong YL, Mustafa MR, et al. Natural indole butyrylcholinesterase



**Haritha et al.,**

- inhibitors from *Nauclea officinalis*. *Phytomedicine* [Internet]. 2015;22(1):45–8. Available from: <http://dx.doi.org/10.1016/j.phymed.2014.11.003>
78. Zhao B, Mochhala SM, Tham SY. Biologically active components of *Physostigma venenosum*. *J Chromatogr B Anal Technol Biomed Life Sci*. 2004;812(1-2 SPEC. ISS.):183–92.
79. Shahwar D, Ahmad N, Yasmeen A, Khan MA, Ullah S, Atta-Ur R. Bioactive constituents from *Croton sparsiflorus* Morong. *Nat Prod Res*. 2015;29(3):274–6.
80. Hacibekiroğlu I, Yılmaz PK, Hacımi N, Kiliç E, Tolan V, Kolak U. In vitro biological activities and fatty acid profiles of *Pistacia terebinthus* fruits and *Pistacia khinjuk* seeds. *Nat Prod Res*. 2015;29(5):444–6.
81. Boğa M, Yılmaz PK, Cebe DB, Fatima M, Siddiqui S, Kolak U. Chemical constituents and biological activities of *Cirsium leucopsis*, *C. sipyleum*, and *C. eriophorum*. *Zeitschrift für Naturforsch - Sect C J Biosci*. 2014;69(9–10):381–90.
82. Boudouda HB, Zeghib A, Karioti A, Bilal AR, Öztürk M, Aouni M, et al. Antibacterial, antioxidant, anti-cholinesterase potential and flavonol glycosides of *Biscutella raphanifolia* (Brassicaceae). *Pak J Pharm Sci*. 2015;28(1):153–8.
83. Al-Qudah M, Al-Jaber H, Mayyas A, Abu-Orabi S, Abu-Zarga M. Chemical Compositions of the Essential Oil From the Jordanian Medicinal Plant *Dittrichia Viscosa*. 2010;5(4):343–8.
84. Nassiri-Asl M, Hosseinzadeh H. Review of the Pharmacological Effects of *Vitis vinifera* (Grape) and its Bioactive Constituents: An Update. *Phyther Res*. 2016;(April):1392–403.
85. Porres-Martínez M, González-Burgos E, Carretero ME, Gómez-Serranillos MP. Protective properties of *Salvia lavandulifolia* Vahl. essential oil against oxidative stress-induced neuronal injury. *Food Chem Toxicol* [Internet]. 2015;80:154–62. Available from: <http://dx.doi.org/10.1016/j.fct.2015.03.002>
86. Kang TH, Jeong SJ, Kim NY, Higuchi R, Kim YC. Sedative activity of two flavonol glycosides isolated from the flowers of *Albizia julibrissin* Durazz. *J Ethnopharmacol*. 2000;71(1–2):321–3.
87. Joseph JA, Shukitt-Hale B, Denisova NA, Bielinski D, Martin A, McEwen JJ, et al. Reversals of age-related declines in neuronal signal transduction, cognitive, and motor behavioral deficits with blueberry, spinach, or strawberry dietary supplementation. *J Neurosci*. 1999;19(18):8114–21.
88. Joseph JA, Shukitt-Hale B, Denisova NA, Prior RL, Cao G, Martin A, et al. Long-term dietary strawberry, spinach, or vitamin E supplementation retards the onset of age-related neuronal signal-transduction and cognitive behavioral deficits. *J Neurosci*. 1998;18(19):8047–55.
89. Abbott NJ. Astrocyte – endothelial interactions and blood – brain barrier permeability \*. 2002;629–38.
90. Xiao Q, Wang C, Li J, Hou Q, Li J, Ma J, et al. Ginkgolide B protects hippocampal neurons from apoptosis induced by beta-amyloid 25-35 partly via up-regulation of brain-derived neurotrophic factor. *Eur J Pharmacol* [Internet]. 2010;647(1–3):48–54. Available from: <http://dx.doi.org/10.1016/j.ejphar.2010.08.002>
91. Bate C, Tayebi M, Williams A. Ginkgolides protect against amyloid- $\beta$ . *Mol Neurodegener*. 2008;3(1):1–9.
92. Shi C, Wu F, Yew DT, Xu J, Zhu Y. Bilobalide prevents apoptosis through activation of the PI3K/Akt pathway in SH-SY5Y cells. *Apoptosis*. 2010;15(6):715–27.
93. Levi-Montalcini R, Skaper SD, Dal Toso R, Petrelli L, Leon A. Nerve growth factor: From neurotrophin to neurokine. *Trends Neurosci*. 1996;19(11):514–20.
94. Chan GKL, Hu WWH, Zheng ZX, Huang M, Lin YXY, Wang CY, et al. Quercetin Potentiates the NGF-Induced Effects in Cultured PC 12 Cells: Identification by HerboChips Showing a Binding with NGF. *Evidence-based Complement Altern Med*. 2018;2018.
95. Tchantchou F, Lacor PN, Cao Z, Lao L, Hou Y, Cui C, et al. Stimulation of neurogenesis and synaptogenesis by bilobalide and quercetin via common final pathway in hippocampal neurons. *J Alzheimer's Dis*. 2009;18(4):787–98.
96. Howes MJR, Perry E. The role of phytochemicals in the treatment and prevention of dementia. *Drugs and Aging*. 2011;28(6):439–68.
97. Hollman PCH, Katan MB. Dietary flavonoids: Intake, health effects and bioavailability. *Food Chem Toxicol*. 1999;37(9–10):937–42.
98. Havsteen BH. The biochemistry and medical significance of the flavonoids. Vol. 96, *Pharmacology and Therapeutics*. 2002. 67–202 p.



**Haritha et al.,**

99. Vafeiadou K, Vauzour D, Spencer J. Neuroinflammation and its Modulation by Flavonoids. *Endocrine, Metab Immune Disord Targets*. 2008;7(3):211–24.
100. Barreca D, Bellocco E, D'Onofrio G, Fazel Nabavi S, Daglia M, Rastrelli L, et al. Neuroprotective Effects of Quercetin: From Chemistry to Medicine. *CNS Neurol Disord - Drug Targets*. 2016 Aug 17;15(8):964–75.
101. Wang DM, Li SQ, Wu WL, Zhu XY, Wang Y, Yuan HY. Effects of long-term treatment with quercetin on cognition and mitochondrial function in a mouse model of Alzheimer's disease. *Neurochem Res*. 2014;39(8):1533–43.
102. Mart PB, Morentin D, Gonz CR. AMP-activated protein kinase: ' a cup of tea ' against cholesterol-induced neurotoxicity. 2010;(October):329–34.
103. Švagera Z, Škottová N, Váňa P, Večeřa R, Urbánek K, Belejová M, et al. Plasma lipoproteins in transport of silibinin, an antioxidant flavonolignan from *Silybum marianum*. *Phyther Res*. 2003;17(5):524–30.
104. Song X, Zhou B, Cui L, Lei D, Zhang P, Yao G, et al. Silibinin ameliorates A $\beta$ 25-35-induced memory deficits in rats by modulating autophagy and attenuating neuroinflammation as well as oxidative stress. *Neurochem Res*. 2017;42(4):1073–83.
105. Chen H, Wang X, Wang M, Yang L, Yan Z, Zhang Y, et al. Behavioral and neurochemical deficits in aging rats with increased neonatal iron intake: Silibinin's neuroprotection by maintaining redox balance. *Front Aging Neurosci*. 2015;7(OCT).
106. Ben-Azu B, Nwoke EE, Umukoro S, Aderibigbe AO, Ajayi AM, Iwalewa EO. Evaluation of the Neurobehavioral Properties of Naringin in Swiss Mice. *Drug Res (Stuttg)*. 2018;68(8):465–74.
107. Qin S, Chen Q, Wu H, Liu C, Hu J, Zhang D, et al. Effects of naringin on learning and memory dysfunction induced by gp120 in rats. *Brain Res Bull* [Internet]. 2016;124:164–71. Available from: <http://dx.doi.org/10.1016/j.brainresbull.2016.04.020>
108. Ramalingayya GV, Nampoothiri M, Nayak PG, Kishore A, Shenoy RR, Rao CM, et al. Naringin and rutin alleviates episodic memory deficits in two differentially challenged object recognition tasks. *Pharmacogn Mag*. 2016;12(45):S63–70.
109. Opinion S. Scientific Opinion on the safety and efficacy of naringin when used as a sensory additive for all animal species. *EFSA J*. 2011;9(11):1–12.
110. Jeong KH, Jung UJ, Kim SR. Naringin Attenuates Autophagic Stress and Neuroinflammation in Kainic Acid-Treated Hippocampus In Vivo. *Evidence-based Complement Altern Med*. 2015;2015.
111. Gopinath K, Sudhandiran G. Naringin modulates oxidative stress and inflammation in 3-nitropropionic acid-induced neurodegeneration through the activation of nuclear factor-erythroid 2-related factor-2 signalling pathway. *Neuroscience* [Internet]. 2012;227:134–43. Available from: <http://dx.doi.org/10.1016/j.neuroscience.2012.07.060>
112. Sachdeva AK, Kuhad A, Chopra K. Naringin ameliorates memory deficits in experimental paradigm of Alzheimer's disease by attenuating mitochondrial dysfunction. *Pharmacol Biochem Behav* [Internet]. 2014;127:101–10. Available from: <http://dx.doi.org/10.1016/j.pbb.2014.11.002>
113. Manchope MF, Calixto-Campos C, Coelho-Silva L, Zarpelon AC, Pinho-Ribeiro FA, Georgetti SR, et al. Naringenin inhibits superoxide anion-induced inflammatory pain: Role of oxidative stress, cytokines, Nrf-2 and the no-cGMP-PKG-KATP channel signaling pathway. *PLoS One*. 2016;11(4):1–20.
114. Kyoung HK, Ki WL, Dong YK, Hyung HP, Ik BK, Hyong JL. Optimal recovery of high-purity rutin crystals from the whole plant of *Fagopyrum esculentum* Moench (buckwheat) by extraction, fractionation, and recrystallization. *Bioresour Technol*. 2005;96(15):1709–12.
115. Kamalakkannan N, Prince PSM. Rutin improves the antioxidant status in streptozotocin-induced diabetic rat tissues. *Mol Cell Biochem*. 2006;293(1–2):211–9.
116. Koda T, Kuroda Y, Imai H. Rutin supplementation in the diet has protective effects against toxicant-induced hippocampal injury by suppression of microglial activation and pro-inflammatory cytokines: PProtective effect of rutin against toxicant-induced hippocampal injury. *Cell Mol Neurobiol*. 2009;29(4):523–31.
117. Javed H, Khan MM, Ahmad A, Vaibhav K, Ahmad ME, Khan A, et al. Rutin prevents cognitive impairments by ameliorating oxidative stress and neuroinflammation in rat model of sporadic dementia of Alzheimer type. *Neuroscience* [Internet]. 2012;210:340–52. Available from: <http://dx.doi.org/10.1016/j.neuroscience.2012.02.046>



**Haritha et al.,**

118. Islam F, Khan MM, Raza SS, Javed H, Ahmad A, Khan A, et al. Rutin protects dopaminergic neurons from oxidative stress in an animal model of parkinson's disease. *Neurotox Res.* 2012;22(1):1–15.
119. Carrasco-Pozo C, Mizgier ML, Speisky H, Gotteland M. Differential protective effects of quercetin, resveratrol, rutin and epigallocatechin gallate against mitochondrial dysfunction induced by indomethacin in Caco-2 cells. *Chem Biol Interact [Internet].* 2012;195(3):199–205. Available from: <http://dx.doi.org/10.1016/j.cbi.2011.12.007>
120. Veitch NC, Grayer RJ. Flavonoids and their glycosides, including anthocyanins. *Nat Prod Rep.* 2008;25(3):555–611.
121. Spencer JPE. The impact of fruit flavonoids on memory and cognition. *Br J Nutr.* 2010;104(SUPPL.3):40–7.
122. Shukitt-Hale B, Cheng V, Joseph JA. Effects of blackberries on motor and cognitive function in aged rats. *Nutr Neurosci.* 2009;12(3):135–40.
123. Kähkönen MP, Hopia AI, Heinonen M. Berry phenolics and their antioxidant activity. *J Agric Food Chem.* 2001;49(8):4076–82.
124. Vauzour D, Vafeiadou K, Rodriguez-Mateos A, Rendeiro C, Spencer JPE. The neuroprotective potential of flavonoids: A multiplicity of effects. *Genes Nutr.* 2008;3(3–4):115–26.
125. Gutierrez JM, Carvalho FB, Schetinger MRC, Marisco P, Agostinho P, Rodrigues M, et al. Anthocyanins restore behavioral and biochemical changes caused by streptozotocin-induced sporadic dementia of Alzheimer's type. *Life Sci [Internet].* 2014;96(1–2):7–17. Available from: <http://dx.doi.org/10.1016/j.lfs.2013.11.014>
126. Hu Y, Xia Z, Sun Q, Orsi A, Rees D. A new approach to the pharmacological regulation of memory: Sarsasapogenin improves memory by elevating the low muscarinic acetylcholine receptor density in brains of memory-deficit rat models. *Brain Res.* 2005;1060(1–2):26–39.
127. Zhao R, McDaniel WF. Ginseng improves strategic learning by normal and brain-damaged rats. *Neuroreport.* 1998;9(7):1619–24.
128. Mook-Jung I, Hong HS, Boo JH, Lee KH, Yun SH, Cheong MY, et al. Ginsenoside Rb1 and Rg1 improve spatial learning and increase hippocampal synaptophysin level in mice. *J Neurosci Res.* 2001;63(6):509–15.
129. Sung HH, Chae MR, So I, Jeon JH, Park JK, Lee SW. Effects of ginsenoside on large-conductance K Ca channels in human corporal smooth muscle cells. *Int J Impot Res.* 2011;23(5):193–9.
130. Shin D, Moon HW, Oh Y, Kim K, Kim DD, Lim CJ. Defensive properties of ginsenoside re against UV-B-induced oxidative stress through Up-regulating glutathione and superoxide dismutase in HaCaT keratinocytes. *Iran J Pharm Res.* 2018;17(1):249–60.
131. Tohda C, Matsumoto N, Zou K, Meselhy MR, Komatsu K. A $\beta$ (25-35)-induced memory impairment, axonal atrophy, and synaptic loss are ameliorated by MI, A metabolite of protopanaxadiol-type saponins. *Neuropsychopharmacology.* 2004;29(5):860–8.
132. Jin G, Wang LH, Ji XF, Chi TY, Qi Y, Jiao Q, et al. Xanthoceraside rescues learning and memory deficits through attenuating beta-amyloid deposition and tau hyperphosphorylation in APP mice. *Neurosci Lett [Internet].* 2014;573:58–63. Available from: <http://dx.doi.org/10.1016/j.neulet.2014.04.032>
133. Li Y, Xu J, Xu P, Song S, Liu P, Chi T, et al. Xanthoceras sorbifolia extracts ameliorate dendritic spine deficiency and cognitive decline via upregulation of BDNF expression in a rat model of Alzheimer's disease. *Neurosci Lett.* 2016;629:208–14.
134. Zhu L, Yang L, Zhao X, Liu D, Guo X, Liu P, et al. Xanthoceraside modulates NR2B-containing NMDA receptors at synapses and rescues learning-memory deficits in APP/PS1 transgenic mice. *Psychopharmacology (Berl).* 2018;235(1):337–49.
135. Liu P, Zou L, Jiao Q, Chi T, Ji X, Qi Y, et al. Xanthoceraside attenuates learning and memory deficits via improving insulin signaling in STZ-induced AD rats. *Neurosci Lett [Internet].* 2013;543:115–20. Available from: <http://dx.doi.org/10.1016/j.neulet.2013.02.065>
136. Lin Z, Gu J, Xiu J, Mi T, Dong J, Tiwari JK. Traditional Chinese medicine for senile dementia. Evidence-based Complement Altern Med. 2012;2012.
137. Zhang H, Han T, Zhang L, Yu CH, Wan DG, Rahman K, et al. Effects of tenuifolin extracted from radix polygalae on learning and memory: A behavioral and biochemical study on aged and amnesic mice. *Phytomedicine.* 2008;15(8):587–94.
138. Zhao Z, Fang M, Xiao D, Liu M, Fefelova N, Huang C, et al. Potential antiarrhythmic effect of methyl 3,4,5-





**Haritha et al.,**

- trimethoxycinnamate, a bioactive substance from roots of polygalae radix: Suppression of triggered activities in rabbit myocytes. *Biol Pharm Bull.* 2013;36(2):238–44.
139. Karakida F, Ikeya Y, Tsunakawa M, Yamaguchi T, Ikarashi Y, Takeda S, et al. Cerebral protective and cognition-improving effects of sinapic acid in rodents. *Biol Pharm Bull.* 2007;30(3):514–9.
140. Wu AG, Wong VKW, Xu SW, Chan WK, Ng CI, Liu L, et al. Onjisaponin b derived from radix polygalae enhances autophagy and accelerates the degradation of mutant  $\alpha$ -synuclein and huntingtin in PC-12 cells. *Int J Mol Sci.* 2013;14(11):22618–41.
141. Ortiz JG, Nieves-Natal J, Chavez P. Effects of Valeriana Officinalis extracts on [3H]flunitrazepam binding, synaptosomal [3H]GABA uptake, and hippocampal [3H]GABA release. *Neurochem Res.* 1999;24(11):1373–8.
142. Chen F, Eckman EA, Eckman CB, Chen F, Eckman EA, Eckman CB. Reductions in levels of the Alzheimer's amyloid  $\beta$  peptide after oral administration of ginsenosides. *FASEB J.* 2006;20(8):1269–71.
143. Fang F, Chen X, Huang T, Lue LF, Luddy JS, Yan SS Du. Multi-faced neuroprotective effects of Ginsenoside Rg1 in an Alzheimer mouse model. *Biochim Biophys Acta - Mol Basis Dis [Internet].* 2012;1822(2):286–92. Available from: <http://dx.doi.org/10.1016/j.bbadis.2011.10.004>
144. Liang W, Ge S, Yang L, Yang M, Ye Z, Yan M, et al. Ginsenosides Rb1 and Rg1 promote proliferation and expression of neurotrophic factors in primary Schwann cell cultures. *Brain Res [Internet].* 2010;1357:19–25. Available from: <http://dx.doi.org/10.1016/j.brainres.2010.07.091>
145. Vishwakarma RK, Patel K, Sonawane P, Kumari U, Singh S, Ruby, et al. Squalene Synthase Gene from Medicinal Herb Bacopa monniera: Molecular Characterization, Differential Expression, Comparative Modeling, and Docking Studies. *Plant Mol Biol Report 2015 336 [Internet].* 2015 Mar 11 [cited 2021 Oct 25];33(6):1675–85. Available from: <https://link.springer.com/article/10.1007/s11105-015-0864-z>
146. Singh HK, Dhawan BN. Effect of Bacopa monniera Linn. (Brāhmi) extract on avoidance responses in rat. *J Ethnopharmacol.* 1982;5(2):205–14.
147. Russo A, Izzo AA, Borrelli F, Renis M, Vanella A. Free radical scavenging capacity and protective effect of Bacopa monniera L. on DNA damage. *Phyther Res.* 2003;17(8):870–5.
148. Dwivedi S, Nagarajan R, Hanif K, Siddiqui HH, Nath C, Shukla R. Erratum: Standardized Extract of Bacopa monniera Attenuates Okadaic Acid Induced Memory Dysfunction in Rats: Effect on Nrf2 Pathway (Evidence-based Complementary and Alternative Medicine). *Evidence-based Complement Altern Med.* 2014;2014.
149. Debnath T, Kim DH, Lim BO. Natural products as a source of anti-inflammatory agents associated with inflammatory bowel disease. *Molecules.* 2013;18(6):7253–70.

**Table No 1: Inclusionary and Exclusionary Criteria for Diagnosing Short-Term and Working Memory Deficits**

Criteria	Preliminary assessment		Follow-up assessment	
	Assessment	Criterion	Assessment	Criterion
<b>Inclusionary: Verbal Short-term memory</b>	Ascending digit span	>1SD <mean	At least a further measure is required. e.g., word recall. (49)	>1SD <mean
<b>Verbal Working memory</b>	Descending digit span	>1SD < mean	At least one further measure is required e.g., listening span, (49)	>1SD < mean
<b>Exclusionary: Hearing</b>	Non-formal	hearing difficulties	Standard audiology	Impaired
<b>Speech-motor Restricted</b>	Non-formal	Pronunciation difficulties	Naming of pictures(50)	Phonological system





Haritha et al.,

Table No 2: Various plants having AChE inhibitory activity

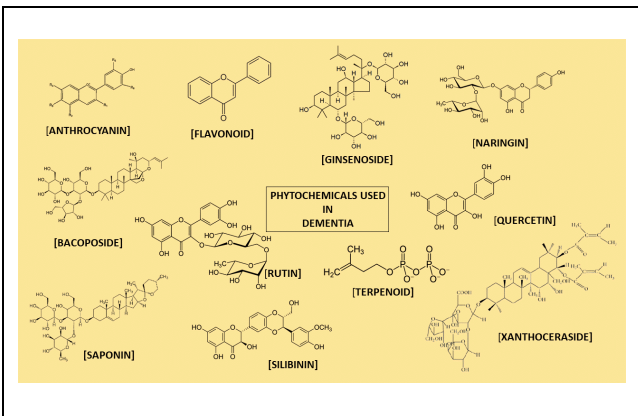
SI. No.	PLANTS	FAMILY	ACTIVE PARTS	CONSTITUENTS
<b>ASIA</b>				
1.	<i>Alpinia officinarum</i>	Zingiberaceae family	Rhizomes	flavonoids, and glycosides(57)
2.	<i>Mentha longifolia</i>	Lamiaceae family	Leaf extracts	Flavonoids and their glycosides, phenolic compounds, triterpenoids, steroids, and lignans, linarin(58)
3.	<i>Cinnamomum zeylanicum</i>	Lauraceae family	Fruit, dried leaves ad oil	Eugenol and cinnamaldehyde(56)
4.	<i>Kopsia arborea</i>	Apocynaceae family	Twigs	monoterpene and indole alkaloids.(59)
5.	<i>Camellia japonica</i>	Theaceae family	Seed cakes	Seed cakes(60)
6.	<i>Tripleurospermum disciforme</i>	Asteraceae family	Flowering tops	artemisia ketone, terpinen-1,8-cineole, sabinene and tricosane(61)
7	<i>Dracocephalum multicaule</i>	Lamiaceae family	Flowering part	Ferulic acid, apigenin, acacetin, luteolin, chlorogenic acid, caffeic acid, oleanolic acid, quercetin (62)
8	<i>Cynometra cauliflora</i>	Fabaceae family	Leaf extracts	Saponins, tannins and flavonoids(63)
9	<i>Piper bavinum</i>	Piperaceae family		bavinol, ampelisin and violanthin(64)
10	<i>Canarium patentinervium</i>	Burseraceae family	Leaves and the bark	vomifoliol, Scopoletin, syringic acid and scoparone(65)
11	<i>Allium stipitatum</i>	Amaryllidaceae family		Pyrithione and related sulfur-containing pyridine N-oxides(66)
12	<i>Daphne holosericea</i>	Thymelaeaceae family	Bark	holosericin A and holosericin B(67)
13	<i>Excoecaria acertiflia</i>	Euphorbaceae family	Stem	exocarinol F, 1,2- bis (4-hydroxy-3-methoxyphenyl) propane-1,3-dioland (7S,8S)-nitidanin, (7S,8S)-5-hydroxynitidanin (68)
14	<i>Garcinia atroviridis</i>	Clusiaceae family	Stem	garcineflavanone A and garcineflavanol A(69)
15	<i>Lycopodiastrum casuarinoides</i>	Licopodiaceae family	Whole plant	huperzine C , N-demethyl huperzine.(70)
16	<i>Lycopodiella cernua</i>	Licopodiaceae family		alkaloid VLC(71)
17	<i>Garcinia mangostana</i>	Clusiaceae family	Fruit	$\alpha$ Mangostin, $\gamma$ Magostin and Garcinone C
18	<i>Marsupella alpine</i>	Gymnomitriaceae family	Whole plant	Sesquiterpenoids(72)
19	<i>Polygonum hydropiper</i>	Polygonaceae family	Crude plant	Saponins, n-hexane, crude extract(73)
20	<i>Momordica charantia</i>	Cucurbitaceae family	Fruits	Triterpenoids(74)
21	<i>Piper betle</i>	Piperaceae family	Leaves	phenylpropanes and a few terpenes (75)



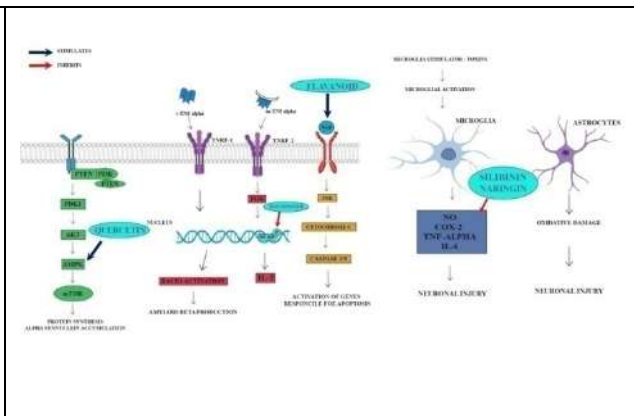


**Haritha et al.,**

22	Essential oils			(76)
<b>AUSTRALIA</b>				
1.	<i>Nauclea officinalis</i>	Rubiaceae family	Bark	angustine, nauclefine, angustidine, harmene and angustoline(77)
<b>AFRICA</b>				
1.	<i>Physostigma venenosum</i>	Fabaceae family	Seeds	Alkaloids(78)
2.	<i>Croton species</i>	Euphorbiaceae family	Leaves	Terpenes (79)
3.	<i>Pistacia terebinthus and Pistacia khinjuk</i>	Anacardiaceae family	Fruits and seeds	Flavonoids(80)
<b>EUROPE</b>				
1.	<i>Cirsium leucopsis, C. sipyleum and C. erioplurum</i>	Asteraceae family	Whole plant	Taraxa-terol(81)
2.	<i>Biscutella raphanifolia</i>	Brassicaceae family	aerial parts	Flavonoid glycosides(82)
3.	<i>Dittrichia viscose</i>	Asteraceae family	Flower, Leaves, Roots and Stem	Quercetin, bufadienolides(83)
4.	<i>Vitis vinifera</i>	Vitaceae family	Leaves	Anthocyanin(84)
5.	<i>Salvia lavandulaefolia</i>	Lamiaceae family	Flowers	essential oil and terpenes(85)
<b>SOUTHAFRICA</b>				
1.	<i>Jacaranda acutifoliatis</i>	Bignoniaceae family	Leaves	Tannins, flavonoids, alkaloids, quinones and traces of saponins



**Figure1: Phytochemicals used in dementia**



**Figure 2: The various neuroprotective molecular mechanisms associated with phytochemicals**







## Antibacterial Activity of Methanolic Extract of Selected Seaweeds against Gram Positive and Gram Negative Organisms

Muruganantham V<sup>1</sup>, Preetha Mathew<sup>2\*</sup>, Venkateswarlu B.S<sup>3</sup> and Muhammed KS<sup>4</sup>

<sup>1</sup>Professor, Department of Pharmaceutics, Vinayaka Missions College of Pharmacy, Salem, Tamil Nadu, India.

<sup>2</sup>Research Scholar, Vinayaka Mission's Research Foundation, Salem, Tamil Nadu, India.

<sup>3</sup>Principal, Vinayaka Missions College of Pharmacy, Salem, Tamil Nadu, India.

<sup>4</sup>Student, Department of Pharmaceutical Sciences, Regional Institute of Medical Science and Research, Puthuppally, Kerala, India.

Received: 07 Dec 2021

Revised: 29 Dec 2021

Accepted: 13 Jan 2022

### \*Address for Correspondence

**Preetha Mathew**

Research Scholar,

Vinayaka Mission's Research Foundation,

Salem, Tamil Nadu, India.

Email: preetha.ammu1@gmail.com



This is an Open Access Journal / article distributed under the terms of the **Creative Commons Attribution License** (CC BY-NC-ND 3.0) which permits unrestricted use, distribution, and reproduction in any medium, provided the original work is properly cited. All rights reserved.

### ABSTRACT

Marine organisms are rich source of structurally novel and biologically active secondary metabolites which leads in the development of new pharmaceutical agents. Seaweeds are marine macro algae which having various nutritional as well as medicinal values. The present work is aimed to evaluate the antibacterial activity of four selected seaweeds against gram positive and gram negative organisms. Four seaweeds namely, *Sargassum cinereum*, *Turbinaria ornata*, *Padina boergesenii* and *Kappaphycus alvarezii* were collected from Rameswaram coast, Tamilnadu, India. Methanolic extracts of four seaweeds were prepared by soxhlet extraction. The antibacterial studies were conducted against *Escherichia coli*, *Klebsiella pneumonia* and *Staphylococcus aureus* by well diffusion method. All the seaweed extracts have shown moderate antibacterial activity. The maximum zone of inhibition ( $23 \pm 0.57$ ) was shown by methanolic extract of *Sargassum cinereum* against *Escherichiacoli* and minimum ( $9 \pm 0.57$ ) shown by methanolic extract of *Turbinaria ornata* against *Klebsiella pneumonea*

**Keywords:** Antibacterial activity, *Sargassum cinereum*, *Padina boergesenii*, *Turbinaria ornata*, *Kappaphycusalvarezii*, well diffusion method

### INTRODUCTION

Traditional and modern medicines have relatively exhausted most of their resources in land plants. However the marine environment by dint of its biological and chemical diversity can be a source of new types of agents against



**Muruganantham et al.,**

cancer and infectious diseases (Zbakh, Chiheb et al. 2012). Marine organisms are source material for structurally unique natural products with pharmacological and biological activities (El Gamal 2010). Among the marine organisms, the macroalgae (seaweeds) occupy an important place as a source of biomedical compounds (Christabell, Lipton et al. 2011). Algae are defined as the photosynthetic nonvascular plants that contain chlorophyll-a and accessory pigments and have simple reproductive structures. They differ from the higher plants in that do not possess true roots, stems or leaves (Jeeva, Marimuthu et al. 2012). However, some of the larger species possess attachment organs called holdfasts that have appearance of roots and there may also be a stem-like portion called a stipe, which flattens out into a broad leaf-like portion called lamina. Some species consists simply of a flat plate of tissue while in others, the plant body, or thallus, is composed of a narrow, compressed or tubular axis with similar branches arising from it. Smaller species are mainly filamentous. Algae vary in size from microscopic unicellular forms (phytoplankton) to the giant benthic macrophytes (e.g., macrocystis), which are attached to solid substrata such as rocks or boulders. The phytoplankton dominates the water column, while the rocky shores are abundantly covered almost exclusively with macroalgae. Muddy and sandy areas have fewer macroalgae because most species cannot anchor there (Adaikalaraj, Patric et al. 2012, Janarthanan and Senthil Kumar 2013).

Algae are located at the base of the food chain for marine organisms. Since the oceans occupy about 71% of the earth's surface area, the role of algae in supporting aquatic life is essential. All marine organisms ultimately depend upon algae for their existence. In addition to directly and indirectly supplying organic molecules for different organisms, algae produce oxygen as a by-product of photosynthesis. They may supply about 30-50% of the net global oxygen. Algae function as chemical modulators in marine ecosystems and also provide habitats for many marine organisms such as snails, limpets, sea urchins etc. Macroalgae can be classified as red algae (rhodophyta), brown algae (pheophyta) or green algae (chlorophyta) depending on their nutrient and chemical composition (Vijayabaskar and Shiyamala 2011, Adaikalaraj, Patric et al. 2012). Red and brown algae are mainly used as human food sources (Manivannan, Anantharaman et al. 2011).

Over the past several decades, seaweeds have generated an enormous amount of interest in the pharmaceutical industry as a fresh source of bioactive compounds with immense medicinal potential (Widowati, Susanto et al. 2014). The first investigation on antibiotic activity of algae was carried out by Pratt *et al.*, (1944). Since algae have been used in traditional medicine for a long time and also some algae have bacteriostatic, bactericidal, antifungal, antiviral and antitumor activity, they have been extensively studied by several researchers (Widowati, Susanto et al. 2014). Marine algae are exploited mainly for the industrial production of phycocolloids such as agar, alginate and carrageen, not for health aspects. Biostimulant properties of seaweeds are explored for use in agriculture and the antimicrobial activities for the development of novel antibiotics. Seaweeds have some of the valuable medicinal components such as antibiotics, laxatives, anticoagulants, antiulcer products, neurotoxins and suspending agents in radiological preparations (Rebecca, Dhanalakshmi et al. 2012, Viswanathan and Nallamuthu 2013). The use of antimicrobial drugs against infectious diseases has certain limitations due to changing patterns of resistance in pathogens and side-effects they produce. These limitations demand for improved pharmacokinetic properties, which necessitates continued research for new antimicrobial compounds for the development of drugs. So, accordingly pharmaceutical industries are giving importance to compounds derived from traditional sources like soil and plants and less traditional sources like marine organisms. Special attention has been reported for antimicrobial and antifungal activities related to marine algae against several pathogens (Viswanathan and Nallamuthu 2013).

The levels of antimicrobial activities of marine algae have showed seasonal and geographical variation. The coastal region of Tamilnadu, South India produces a rich vegetation of marine algae. Many studies have reported a great diversity in the macroalgal community of the marine algal vegetation in the region. Among the seaweeds in the region, the brown algae, *Padina* species and a red algae, *Kappaphycus* species grow in abundance as dominant communities in the shores of Kanyakumari and Ramanathapuram districts of Tamilnadu state, South India (Karthikaidevi, Manivannan et al. 2009, Manivannan, Anantharaman et al. 2011). The present work is aimed to evaluate the efficiency of methanolic extracts of *Sargassum cinereum*, *Turbinaria ornata*, *Padina Boergesenii* and *Kappaphycus alvarezii*, as antibacterial agents collected from the coastal region of Rameswaram, Tamilnadu state.





## MATERIALS AND METHODS

### Collection of Samples

Samples of *Sargassum cinereum*, *Padina boergesenii*, *Turbinaria ornata* and *Kappaphycus alvarezii* were collected from the coastal region of Rameswaram, Tamilnadu state, India. Algae were thoroughly washed in sea water to remove the macroscopic epiphytes, sand particles and other extraneous matters. Then it rinsed with fresh water and spread out at room temperature for drying. Taxonomic identification of the collected seaweeds was done in Department of Marine Biology, Cochin University of Science and Technology, Kerala, India.

### Preparation of Extracts

Collected algae samples were dried at room temperature in shady place. The dried seaweeds were crushed to make coarse powder by an electric grinder. Each sample of seaweed powders were separately extracted by Soxhlet extraction. 5g of powder sample were packed in Soxhlet extractor and extraction was carried out by using 200ml methanol for 24hours. The crude extract was collected and concentrated. The concentrated extracts of seaweeds were stored in -20°C until tested.

### Bacterial Strains

Bacterial strains used in this study were *Staphylococcus aureus*, *Escherichia coli* and *Klebsiella pneumoniae*. These strains were collected from the Department of microbiology, Regional Institute of Medical Science and Research, Puthupally, Kottayam, Kerala, India.

### Antibacterial Activity Test

Ciprofloxacin infusion (Cipla Ltd. Inida) was used as the standard antibiotic for compare the antibacterial efficacy of the samples under test. Antibacterial activity studies were conducted by using well diffusion method in sterile petri dishes. Plates were prepared by pouring the nutrient agar medium, seeding them with test organisms and allowed to set. Wells made in the medium using a sterile cork borer about 10mm in diameter. 50µl of the samples and standard antibiotic solution (10µg) were filled in the wells made on the plates. Plates were left at room temperature for 1-2 hours as period of pre-incubation diffusion. After that plates were incubated for about 18 hours at 37°C and diameter or area of the circular inhibition zone was measured using zone reader.

## RESULTS

Antibacterial activity of the standard drug, Ciprofloxacin and the methanolic extracts of selected seaweeds such as *Sargassum cinereum*, *Padina boergesenii*, *Turbinaria ornata* and *Kappaphycus alvarezii* against gram negative organisms such as *Escherichia coli* & *Klebsiella pneumonia* and gram positive *Staphylococcus aureus* compressed as zone of inhibition shown in Table:1. The zone of inhibition shown by the methanolic extract of *Sargassum cinereum* against *Staphylococcus aureus* (24.60±0.33) is larger than that against *Escherichia coli* (23.00±0.57) and *Klebsiella pneumonia* (22.60±0.33). Extract of *Padina boergesenii* shows maximum zone of inhibition against *Staphylococcus aureus* (12.60±0.33) & *Klebsiella pneumonia* (12.60±0.33) and minimum zone of inhibition against *Escherichia coli* (12.30±0.33). *Turbinaria ornata* shows large zone of inhibition against *Staphylococcus aureus* (11.60±0.33) than that against *Escherichia coli* (10.30±0.33) and *Klebsiella pneumonia* (9.00±0.57). *Kappaphycus alvarezii* shows more zone of inhibition against *Escherichia coli* (19.00±0.57) than that against *Klebsiella pneumonia* (15.60±0.33) and *Staphylococcus aureus* (14.30±0.33).

## DISCUSSION

There is high expectation that organisms from the marine environment will yield a vast array of new pharmaceutical compounds with novel activities that will provide new drugs in the fight against a number of microbial pathogens currently developing resistance to conventional antibiotic therapies (Ramalingam and Amutha 2013, Djinni, Defant



**Muruganantham et al.,**

et al. 2014). Seaweeds provide a rich source of structurally diverse secondary metabolites (Bibiana, Nithya et al. 2012). These secondary metabolites offers defence against herbivores, fouling organisms and pathogens (Shanmughapriya, Manilal et al. 2008, Karthikaidevi, Manivannan et al. 2009). The ability of seaweeds to produce secondary metabolites of antimicrobial value, such volatile components as phenols and terpenes, steroids, phlorotannins, lipids, etc.(Oumaskour, Boujaber et al. 2013).Antimicrobial activity of seaweeds may be influenced by some factors such as the habitat and season of algal collection (Choi, Ha et al. 2014), different growth stages of plant, experimental methods, etc. A few researchers tried using different solvents for screening of antimicrobial activity of seaweeds and made comparison (Manivannan, Anantharaman et al. 2011). A.Ramalingam and C.Amutha (2013) found that methanol is the suitable solvent in extracting majority of the seaweeds, and (Rhimou, Hassane et al. 2013) reported that extracts prepared with methanol showed the best activity.In the present study antibacterial activity of selected seaweeds from the class of Pheophyceae and Rhodophyceae against gram negative and gram positive pathogens were tested. A number of previous studies have revealed the antibiotic importance of seaweeds. In this study red alga, *Kappaphycus alvarezii* had exhibit higher inhibition activity against gram negative organisms than gram positive organism. But brown algae like *Sargassum cinereum*, *Padina boergesenii* and *Turbinaria ornata* had exhibit higher inhibition activity against gram positive organism than gram negative organisms. Previous investigations revealed higher antibacterial activity in the extract of brown algae than red algae extract (Sujatha, Govardhan et al. 2012, Ramalingam and Amutha 2013). Present study also indicating that higher inhibition activity of *Sargassum cinereum* (brown alga) than *Kappaphycus alvarezii* (Red alga). *Sargassum cinereum* had shown larger zone of inhibition than other brown algae chosen in this study, ie, *Padina boergesenii* and *Turbinaria ornata*.Methanolic extracts of all seaweeds tested in this study exhibited a broad spectrum of antibacterial activity with inhibition of diameters ranging from 9.00±0.57 to 24.60±0.33. In the present investigation, higher activity was recorded from *Sargassum cinereum* followed by *Kappaphycus alvarezii*, *Padina boergesenii* and *Turbinaria ornata*.

## CONCLUSION

Seaweeds have been shown to possess number of biological activities. The seaweed extract of *Sargassum cinereum*, *Padina boergesenii*, *Turbinaria ornata* and *Kappaphycus alvarezii* were tested for its antibacterial effect significantly showed zone of inhibition against all the three tested microorganisms; *Escherichia coli*, *Klebsiella pneumonia* and *Staphylococcus aureus*. The maximum zone of inhibition was shown by the methanolic extract of *Sargassum cinereum* against *Escherichia coli*. The investigations and exploitation of the wide medicinal potentials of marine algae will have significant health implications for current and future generations. The scopes of using seaweeds in the development of new pharmaceutical agents are having new hope in the present study.

## REFERENCES

1. Adaikalaraj, G., R. D. Patric, M. Johnson, N. Janakiraman and A. Babu (2012). "Antibacterial potential of selected red seaweeds from Manapad coastal areas, Thoothukudi, Tamil Nadu, India."Asian Pacific Journal of Tropical Biomedicine2(2): S1077-S1080.
2. Bibiana, M. A., K. Nithya, M. Manikandan, P. Selvamani and S. Latha (2012). "Antimicrobial evaluation of the organic extracts of *Sargassum wightii* (brown algae) and *Kappaphycus alvarezii* (red algae) collected from the coast of Meemesal, Tamilnadu."Int. J. Pharm. Chem. Biol. Sci2(4): 439-446.
3. Choi, J.-S., Y.-M. Ha, B.-B. Lee, H. E. Moon, K. K. Cho and I. S. Choi (2014). "Seasonal variation of antibacterial activities in the green alga *Ulva pertusa* Kjellman."Journal of Environmental Biology35(2): 341.
4. Christabell, J., A. Lipton, M. Aishwarya, A. Sarika and A. Udayakumar (2011). "Antibacterial activity of aqueous extract from selected macroalgae of southwest coast of India."Seaweed Research Utilization33(1 & 2): 67-75.
5. Djinni, I., A. Defant, M. Kecha and I. Mancini (2014). "Metabolite profile of marine-derived endophytic *Streptomyces sundarbansensis* WR1L1S8 by liquid chromatography–mass spectrometry and evaluation of culture conditions on antibacterial activity and mycelial growth."Journal of applied microbiology116(1): 39-50.
6. El Gamal, A. A. (2010). "Biological importance of marine algae."Saudi Pharmaceutical Journal18(1): 1-25.





**Muruganatham et al.,**

7. Janarthanan, M. and M. Senthil Kumar (2013). "Qualitative and Quantitative Analysis of Phytochemical Studies on Selected Seaweeds *Acanthopora Spicifera* and *Sargassum Wightii*." *International Journal of Engineering Research and Development* e-ISSN: 11-15.
8. Jeeva, S., J. Marimuthu, C. Domettila, B. Anantham and M. Mahesh (2012). "Preliminary phytochemical studies on some selected seaweeds from Gulf of Mannar, India." *Asian Pacific Journal of Tropical Biomedicine*2(1): S30-S33.
9. Karthikaidevi, G., K. Manivannan, G. Thirumaran, P. Anantharaman and T. Balasubramanian (2009). "Antibacterial properties of selected green seaweeds from Vedalai coastal waters; Gulf of Mannar marine biosphere reserve." *Global J Pharmacol*3(2): 107-112.
10. Manivannan, K., P. Anantharaman and T. Balasubramanian (2011). "Antimicrobial potential of selected brown seaweeds from Vedalai coastal waters, Gulf of Mannar." *Asian Pacific journal of tropical biomedicine*1(2): 114-120.
11. Oumaskour, K., N. Boujaber, S. Etahiri and O. Assobhei (2013). "Anti-inflammatory and antimicrobial activities of twenty-three marine red algae from the coast of sidi bouzid (el jadida-morocco)." *International Journal of Pharmacy and Pharmaceutical Sciences*5: 145-149.
12. Ramalingam, A. and C. Amutha (2013). "Antibacterial Activity of Four Seaweeds Collected from Thondi Coast, Tamilnadu, India." *International Journal of Research in Biological Sciences*3(1): 60-64.
13. Rebecca, L. J., V. Dhanalakshmi and C. Shekhar (2012). "Antibacterial activity of *Sargassum Illicifolium* and *Kappaphycus alvarezii*." *J. Chem. Pharm. Res*4(1): 700-705.
14. Rhimou, B., R. Hassane, M. José and B. Nathalie (2013). "The antibacterial potential of the seaweeds (*Rhodophyceae*) of the Strait of Gibraltar and the Mediterranean Coast of Morocco." *African Journal of Biotechnology*9(38): 6365-6372.
15. Shanmughapriya, S., A. Manilal, S. Sujith, J. Selvin, G. S. Kiran and K. Natarajaseenivasan (2008). "Antimicrobial activity of seaweeds extracts against multiresistant pathogens." *Annals of Microbiology*58(3): 535-541.
16. Sujatha, L., T. L. Govardhan and G. S. Rangaiah (2012). "Antibacterial activity of green seaweeds on oral bacteria." *Indian journal of Natural products and Resources*3(3): 328-333.
17. Vijayabaskar, P. and V. Shiyamala (2011). "Antibacterial activities of brown marine algae (*Sargassum wightii* and *Turbinaria ornata*) from the Gulf of Mannar Biosphere Reserve." *Advances in Biological Research*5(2): 99-102.
18. Viswanathan, S. and T. Nallamuthu (2013). "Screening of Phytochemical and Antibacterial activity of three different seaweeds from Gulf of Mannar, Tamilnadu."
19. Widowati, I., A. Susanto, M. Puspita, V. Stiger-Pouvreau and N. Bourgougnon (2014). "Antibacterial and Antioxidant Properties of The Red Alga *Gracilaria verrucosa* from The North Coast of Java, Semarang, Indonesia." *International Journal of Latest Research in Science and Technology*3(3): 179-185.
20. Zbakh, H., H. Chiheb, H. Bouziane, V. Motilva and H. Riadi (2012). "Antibacterial activity of benthic marine algae extracts from the Mediterranean coast of Morocco." *J Microbiol Biotechnol Food Sci*2(1): 219-228.

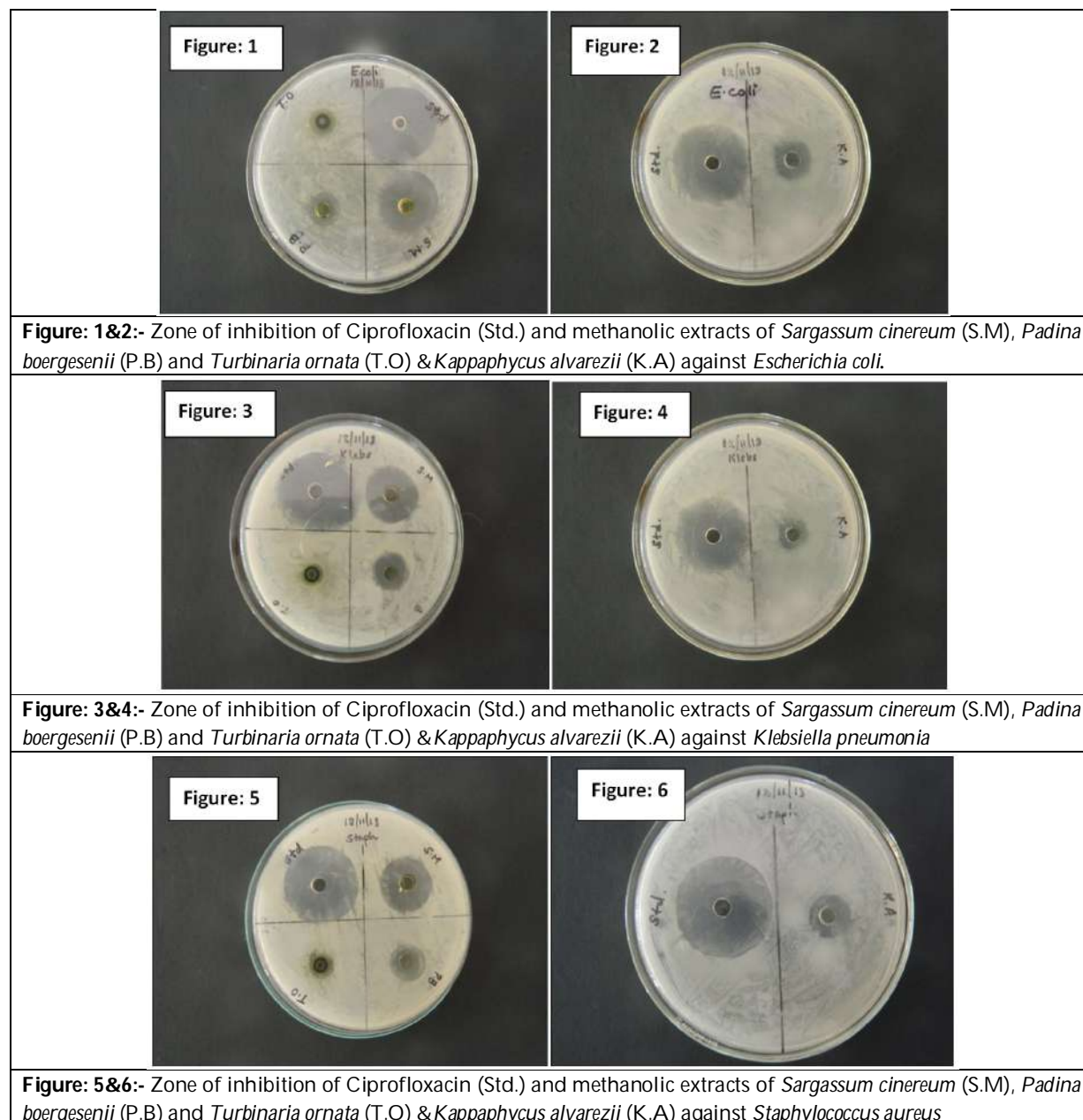
**Table: 1. Zone of inhibition shown by methanolic extract of selected seaweeds against gram +ve and gram –ve microorganisms.**

Treatment	Antibacterial activity against human pathogens compressed as zone of inhibition in mm		
	<i>Escherichia coli</i>	<i>Klebsiella pneumonia</i>	<i>Staphylococcus aureus</i>
Ciprofloxacin	33.60±0.33	31.00±0.57	31.60±0.33
<i>Sargassum cinereum</i>	23.00±0.57	22.60±0.33	24.60±0.33
<i>Padina boergesenii</i>	12.30±0.33	12.60±0.33	12.60±0.33
<i>Turbinaria ornata</i>	10.30±0.33	9.00±0.57	11.60±0.33
<i>Kappaphycus alvarezii</i>	19.00±0.57	15.60±0.33	14.30±0.33





Muruganatham et al.,





## Basics of Palliative Care

Malathi.S<sup>1</sup> and Dhanalakshmi.J<sup>2\*</sup>

<sup>1</sup>Professor and HOD, Department of Community Health Nursing, Vinayaka Missions Research Foundation, Salem, Tamil Nadu, India.

<sup>2</sup>Research Scholar in Nursing, Vinayaka Missions Research Foundation, Salem, Tamil Nadu, India.

Received: 08 Nov 2021

Revised: 14 Dec 2021

Accepted: 17 Jan 2022

### \*Address for Correspondence

#### Dhanalakshmi.J

Research Scholar in Nursing,  
Vinayaka Missions Research Foundation,  
Salem, Tamil Nadu, India.



This is an Open Access Journal / article distributed under the terms of the **Creative Commons Attribution License** (CC BY-NC-ND 3.0) which permits unrestricted use, distribution, and reproduction in any medium, provided the original work is properly cited. All rights reserved.

### ABSTRACT

A World Health Organization statement describes palliative care as "An approach that improves the quality of life of patients and their families dealing with problems associated with life-threatening illness by preventing and alleviating suffering through early detection, accurate assessment, and treatment of pain and other psychosocial, physical and spiritual problems." Palliative care includes all aspects of a person's health, including their body, mind, and spirit, as well as their heart and soul. Palliative care is appropriate for people of all ages who are suffering from serious illnesses, and it can be administered as a main goal of care or in addition with curative treatment.

## INTRODUCTION

### Issues Addressed In Palliative Care

Palliative care is important with a wide range of issues by incorporating individual, unique needs into treatment. Cancer's physical and emotional impacts, as well as its treatment, can differ widely from person to person.

Physical

Emotional and coping

Practical

Spiritual

**Physical:** Pain, fatigue, loss of appetite, vomiting, nausea, shortness of breath and insomnia are all physical symptoms that can be treated with medications or other ways such as nutrition therapy, physical therapy or deep breathing techniques.

**Emotional and coping:** Palliative care can help people with anxiety, depression and fear. Counseling, support groups, family meetings and referrals to mental health specialists are all possibilities.





### Malathi and Dhanalakshmi

**Practical:** Financial and legal issues, insurance questions, work concerns and concerns about completing advance directives are all common concerns among patients. The complex language and specific details of regulations and forms are difficult to understand for many patients and families.

**Spiritual:** A palliative care professional can assist people in exploring their beliefs and values in order to find a sense of peace or acceptance that is appropriate for their situation.

#### Goals

The goals of palliative care are:

- To improve one's quality of life.
- To provide pain and other bodily problems relief.
- To offer psychosocial and spiritual assistance.
- To offer support to the patient's family during their illness and subsequent bereavement.

#### Principles

Palliative care honors the dying person's goals, preferences and choices, as well as those of his or her loved ones. Assisting them in comprehending the sickness and what to expect from it, as well as determining what is most important during this time.

Palliative care attends to a dying person's physical, emotional, social and spiritual needs, with a focus on ensuring that he or she is comfortable, not alone, and able to reflect on his or her life and find meaning.

Palliative care meets the requirements of family members, assisting them with care giving chores and even providing emotional support while they grieve.

Palliative care facilitates access to essential health care professionals and suitable care settings...involving a variety of trained providers in a variety of locations, all tailored to the patient's and family's requirements.

Palliative care develops methods for providing quality end-of-life care...through provider education, suitable health policies and adequate funding from insurers and the government.

#### Settings

Palliative care is available in a variety of settings, including

Hospitals,  
Outpatient,  
Skilled-nursing, and  
Home settings.

#### Indications

People of any age who are suffering from a serious or life-threatening illness may be eligible for palliative treatment. It can assist adults and children who are suffering from illnesses such as:

- Cancer
- Blood and bone marrow disorders requiring stem cell transplant
- Heart disease
- Kidney failure
- Lung disease
- Cystic fibrosis
- Dementia
- End-stage liver disease
- Stroke
- Parkinson's disease







**Malathi and Dhanalakshmi**

Symptoms that may be improved by palliative care include:

- Pain
- Nausea or vomiting
- Difficulty breathing
- Anorexia
- Fatigue
- Anxiety or nervousness
- Depression or sadness
- Constipation
- Trouble sleeping

**Elements**

Palliative treatments vary widely and often include:

- Symptom control
- Patient education
- Family education and support
- Recognition of spiritual suffering
- Emotional and spiritual support
- Psychological support
- Nutritional changes
- Relaxation techniques
- Medication
- Advance care planning

**Components of Service**

1. In –patient palliative care service
2. Out –patient palliative care service,
3. Consultative palliative care service in general wards
4. Consultative palliative care service in other hospitals
5. Palliative care units.
6. Community palliative care service
7. Day palliative care service.

**Team**

**General care professionals**

Palliative care is provided to people on a daily basis through general health and social care professionals.

- District or community nurses
- Social workers
- Care workers
- Spiritual care professionals.

**Specialist care professionals**

Specialist palliative care professionals are trained and experienced in delivering palliative care and are experts in this field. They may be involved in the management of more complex care issues. Specialists frequently work in groups to provide coordinated care, and if you're referred to them, you may see one or more of them.

**Specialist teams include**

- Palliative care doctors
- Nurse specialists
- Counsellors
- Specialist health professionals, such as physiotherapists, dieticians, occupational therapists and social workers.





### Malathi and Dhanalakshmi

#### Stages of Palliative Care

Stage 1: This is where the initial plan is created; it should be flexible to provide the right care as your illness evolves. Health care professionals, patient and family, are involved in making this plan.

Stage 2: Medical social workers, interdisciplinary teams and chaplains provide emotional and spiritual care for you and your family.

Stage 3: At this phase in the treatment plan, nurses and physicians collaborate to ensure that you preserve as much independence as feasible. Placing home health aides and accepting support from carers with daily routines that you are beginning to struggle with may be necessary at this point.

Stage 4: This stage arranging inpatient care at a hospital or hospice if wanted. If you don't want this but still need more medical assistance than before, live-in care can be arranged so that you always get the attention you need without having to leave your home. This stage might also include care for those who are nearing the end of their lives.

Stage 5: This involves bereavement support for your family and friends and is usually utilized for a year.

#### Philosophy and Practice

The world health organization (2006) summarizes palliative care philosophy and practice as follows:-

- o Affirms life and regards dying as a normal process
- o Neither hastens nor postpones death
- o Provides relief from pain and other distressing symptoms
- o Integrates psychological and spiritual aspects of patients care
- o Offers a support system to help patients live as active as possible until death
- o Offers a support system to help families cope during the patients illness and their own bereavement
- o Enhance the quality of life
- o Uses a team approach to meet the needs of patients and families.

#### Palliative Care

- Includes physical difficulties such as pain and other painful symptoms, psychological anguish, spiritual distress, and social requirements, as well as prevention, early detection, full assessment, and management. These interventions must be evidence-based whenever possible.
- Assists patients in living as completely as possible until death by encouraging efficient communication and assisting them and their families in determining care objectives.
- Can be used at any time throughout an illness, depending on the needs of the patient.
- When necessary, is used in conjunction with disease-modifying therapies.
- Has the potential to impact the course of an illness in a good way.
- Has no intention of hastening or postponing death, affirms life, and accepts death as a natural process.
- Supports the patient's family and carers during the patient's illness and mourning.
- Is given while taking into account and honoring the patient's and family's cultural values and beliefs.
- Can be used in all types of health care settings (homes and institutions) and at all levels (primary to tertiary).
- Professionals with basic palliative care training can deliver it.
- Referral of difficult cases necessitates specialised palliative care from a multi professional team.

#### REFERENCES

1. Carol R.Taylor,(2008)"Fundamentals of nursing", Volume II, 6th edition, wolters kluwer/Lippincott Williams &wilkin's, Newdelhi, page No.989.
2. Prof. Sowmyakurian, (2019) "A text book of Nursing foundation", 1st edition, All win medical books publishers, Banglore, page no.742
3. Potter-Perry, "Basic nursing", 7th edition, published by Elsevier, New Delhi, Page no:667-668
4. Zhukovskiy D (2019). "Primer of Palliative Care". American Association of Hospice and Palliative Medicine



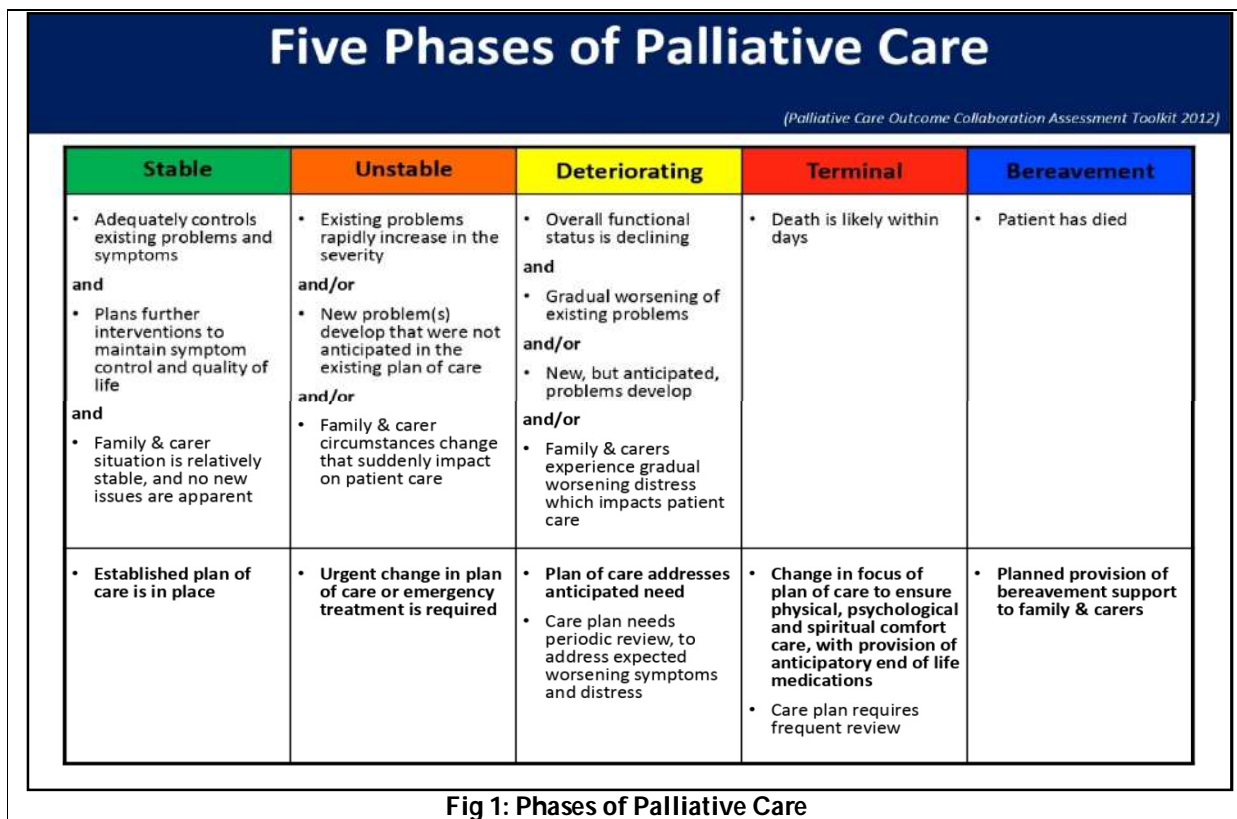


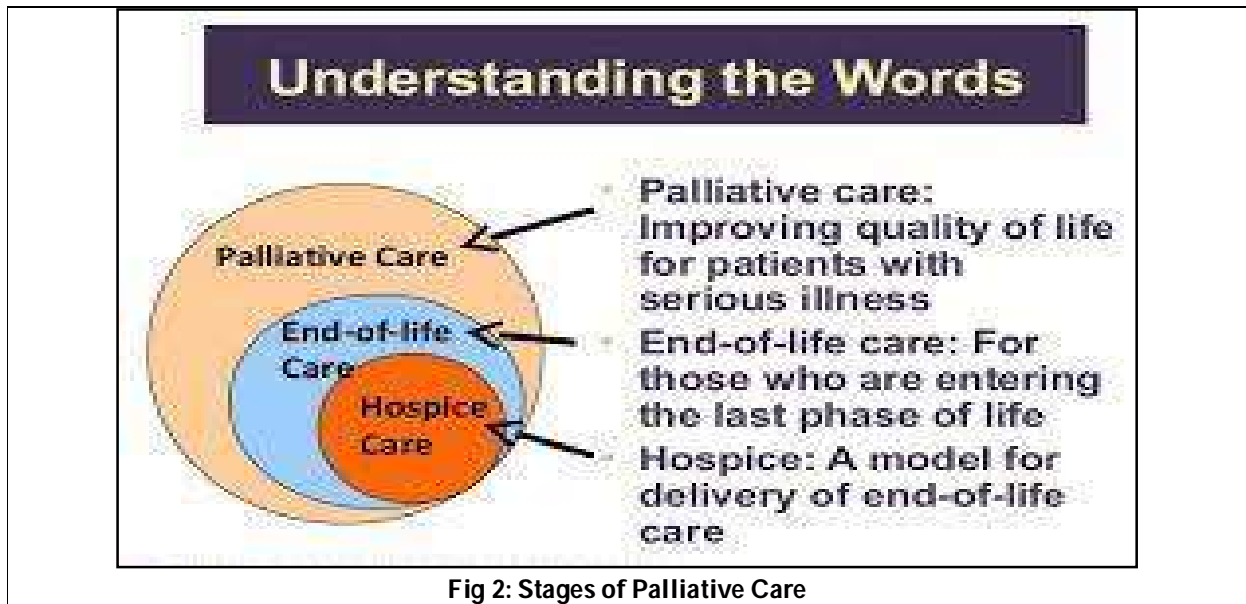
**Malathi and Dhanalakshmi**

5. <https://aci.health.nsw.gov.au/palliative-care-blueprint/the-blueprint/principles>
6. <https://www.mayoclinic.org/tests-procedures/palliative-care/about/pac-20384637>
7. <https://hospicecare.com/what-we-do/publications/getting-started/what-is-palliative-care/>
8. <https://www.mariecurie.org.uk/help/support/diagnosed/recent-diagnosis/palliative-care-end-of-life-care#who>
9. <https://www.fouroakhealthcare.co.uk/blog/5-stages-of-palliative-care/>

**Table 1: Palliative Care Vs Hospice Care**

Palliative care	Hospice care
Chronic or progressive illness but seeking curative treatment	Chronic or progressive illness –focusing on comfort NOT a cure
No life expectancy requirements to receive palliative services	Requires life expectancy of 6 months or less
Manages symptoms and assists with advance care planning WHILE receiving aggressive/invasive treatment	Manages symptoms and helping patients/family transition with end of life care
Care is provided in conjunction with primary physician or specialist	Hospice physician and care team take over care.







## Effect of Plyometrics on Various Biochemical Variables in Obese Adults

Nandakumar R<sup>1\*</sup>, Anand V<sup>2</sup>, Alagappan Thiyagarajan<sup>3</sup>, Vanitha R<sup>4</sup> and Aswinkumar S<sup>5</sup>

<sup>1</sup>Ph.D Scholar, Madhav University, Rajasthan, Principal and Professor, Shree Venkateshwara College of Paramedical Sciences, Gobichettipalayam, Erode. Tamil Nadu, India

<sup>2</sup>Professor, Madhav University, Rajasthan. India.

<sup>3</sup>Department of Sports Medicine, Chettinad Hospital and Research Institute, Chennai, Tamil Nadu, India.

<sup>4</sup>Associate Professor, Shree Venkateshwara College of Paramedical Sciences, Gobichettipalayam, Erode, Tamil Nadu, India.

<sup>5</sup>Assistant Professor, Shree Venkateshwara College of Paramedical Sciences, Gobichettipalayam, Erode, Tamil Nadu, India

Received: 10 Nov 2021

Revised: 20 Dec 2021

Accepted: 13 Jan 2022

### \*Address for Correspondence

#### Nandakumar R

Ph.D Scholar, Madhav University, Rajasthan,  
Principal and Professor,  
Shree Venkateshwara College of Paramedical Sciences,  
Gobichettipalayam, Erode, Tamil Nadu, India.



This is an Open Access Journal / article distributed under the terms of the **Creative Commons Attribution License** (CC BY-NC-ND 3.0) which permits unrestricted use, distribution, and reproduction in any medium, provided the original work is properly cited. All rights reserved.

### ABSTRACT

Obesity is an abnormal accumulation of fat in the body, which risk to health. Obesity is always associated with diabetes, cardiac disease, stroke, and some forms of cancer. Obesity causes a huge increase in biochemical values in the serum. Controlling these biochemical variables is important in managing obesity. Common treatment includes proper diet, physical activity, and lifestyle modification. Exercises play a major role in reducing obesity. Various forms of exercises are available, but none of them are found to be effective. Plyometric training is a form of short-stretch drill which always used in sports activities. This study aims to find out the effect of plyometric exercises on various biochemical variables in obese adults. An Experimental study includes 48 obese adults who volunteered to participate in this study and selected based on selection criteria. Explanation about the study was given to all the volunteers, randomization methods. Group A was trained with Plyometric exercises for upper and lower limbs for 45 minutes. Group B participants were trained with aerobic exercises for 45 minutes, added five minutes of warming up and ten minutes of cooldown. The outcome measure for this study was Blood pressure, HDL, LDL, and Random blood sugar levels (RBS). Blood pressure was assessed using a Sphygmomanometer, RBS, HDL & LDL were assessed using serum analysis. Statistical analysis was performed using SPSS 20.0. The results of the study show that Group A has 't' values of  $30.08 \pm 3.01$ ,  $40.27 \pm 0.85$ ,  $12.89 \pm 1.38$ ,  $23.02 \pm 1.13$ , for RBS, SBP, HDL & LDL respectively and for the Group B has 't' values of  $24.04 \pm 2.33$ ,  $18.60 \pm 1.17$ ,  $09.33 \pm 0.995$ ,  $17.84 \pm 0.69$ . This study concluded that a significant difference was obtained between the plyometric exercises and aerobic exercises on various biochemical variables. It also identified that Plyometric exercises are superior in reducing the SBP, RBS, LDL, and increase in HDL levels compared with aerobic exercises.

**Keywords:** Obese adults, Plyometrics, Aerobics, Systolic blood pressure, Random blood sugar, High-density lipoproteins, Low-density lipoproteins. :



**Nandakumar et al.,**

## INTRODUCTION

Obesity is one of the most neglected health problems that lead to cardiovascular disorders and diabetes. Overweight and obesity are rapidly increasing in India [1]. There are 1.9 billion overweight adults and 650 million obese adults in the world. WHO stated that globally one in every six adults is obese, according to the WHO statistics in 2012. Overweight and obesity are becoming major health problems in developing and developed countries [2]. The transitional stage of undernutrition due to poverty and obesity due to the industrialization and rapid urbanization in India may pronounce more obesity. There are about 135 million were affected by obesity in India [3]. Obesity is strongly associated with various metabolic disorders, including hypertension, diabetes mellitus, dyslipidemia, cardiovascular diseases, and some forms of cancers [4]. Obesity is an excess accumulation of fatty tissues to impair physical and psychological health. Obesity is considered a healthcare disaster in developing countries [5]. The risk of obesity starts to appear when the body mass index is above 30 kg/m<sup>2</sup> [6]. The study predicted that around 20% of rural Indian adults will be overweight or obese by 2030 [7]. Nutritional transition is the cause of the higher risk of overweight in rural Indian adults, especially among individuals with high socioeconomic status.

Overweight or obese children often become overweight adults. A child with a high BMI has a higher risk of being overweight or obese at 35 years, and the risk increases with age [8]. Deposition of the fat in the subcutaneous tissues could cause atherosclerosis at 36 years [9]. Insulin resistance in the body is commonly seen when fat accumulation is central. The amount of body fat and its distribution, also known as adiposity, is a health risk factor [10]. Obesity is associated mainly with the alteration of blood pressure, cholesterol, and blood sugar values. There is a strong relationship between metabolic health and obesity [11]. It is estimated that metabolically healthy obesity is between 10% to 51% [12]. Obesity can be controlled with a combination of lifestyle therapies such as diet, physical activity, behavioral change, and healthy eating [13]. Obesity management relies heavily on lifestyle changes and counseling [14]. Exercising is one of the most effective ways to manage overweight and obesity. Exercises play an integral part in weight loss management [15]. There are different types of exercises prescribed in managing obesity. Some studies support aerobic exercises for weight reduction [16,17,18], and few other supports resistance training [19,20]; as management, some studies endorse a combination of aerobics and resistance in reducing obesity [21]. Plyometric exercises are short stretch drills with a rapid cycle of movements that involves high-intensity eccentric contractions immediately after an immediate and powerful concentric contraction [22]. It is designed to enhance muscular power and explosiveness. It consists of fast and powerful movements [23]. Studies show that plyometrics cause calories burn and improve metabolism, which facilitates weight loss [24]. Exercises play a significant role in reducing obesity, and plyometrics are not much studied on the effects on managing obesity. Since there are no such studies on plyometrics on obesity in adults, this study aimed to identify the impact of various biochemical variables in obese adults. This study hypothesized that there would be no significant difference in applying plyometric exercises on obese adults.

## MATERIALS AND METHODS

The study was approved by the institutional ethical committee, Madhav University, Rajasthan. A survey was conducted on the college campus, which has around 800 students, to identify the sample for the study. One hundred forty volunteers were picked up from the population, and they were given appointments for further evaluations. Explanation about the study was given to all the selected samples, and those who were willing were involved in this study for further evaluation. Eighty participants were selected based on the predetermined selection criteria; from that population, fifty-two were selected randomly and assigned into two groups by using computer-assisted randomization methods, and they were divided into two equal groups, twenty-four participants in each group. Selection criteria for this study are age group of 21—35 years, both genders involved (Male =34, female =14), participants with BMI More than 25 kg/mg<sup>2</sup>, (Overweight & Obese), Blood sugar level of random blood sugar level is 155, Blood pressure of above 155 in systolic, able to walk 10 meters without breathlessness, participants without any recent musculoskeletal injuries around the lower limbs, without any cardiovascular problems, not participating or



**Nandakumar et al.,**

doing any weight reduction programs, and without any psychological issues. Written consent was obtained from all the participants before the study. Before the survey, a bit of clear advice was given on diet modifications, home programs, and lifestyle changes to all the participants. The study was conducted three times a week for eight weeks. WhatsApp group was created for each group and advised them to post their queries related to exercises and home programs. Participants in Group A were trained with Plyometric exercises for upper and lower limbs for 45 minutes, warm-up session for 5 mins and cool down for 10 mins also added. Group B participants were trained with aerobic exercises for 45 minutes. A session of warm-up for 5 mins and cool down for 10 mins also added. Plyometric training includes three sets based on weeks, week 1—3, double leg jump exercises, medicine ball overhead throw, medicine ball single-leg dip. Week 4—6, hurdle hops, zig-zag jump drill, medicine ball backward throws, week 6—8, single-leg cone hops, zig-zag jump drills, and medicine ball backward throws. Initially, the training starts with basic movements and progresses to complex ones [25]. Each exercise was maintained for 2 mins, between each block or a new exercise recovery period of 2 mins was given.

Aerobic exercises include walking for 10 minutes at an average pace in the ground, arm crank ergometer for 10 mins, bicycle ergometer for 10 min, elliptical trainer for 10 mins, and 5 mins of slow walking. The exercise was done with 60% of heart rate reserve (HRR) with ten beats per min. HRR was estimated using the Karvonen equation (220-age-resting heart rate) [26]. Outcome measures of this study include Blood pressure, HDL, LDL, and Random blood sugar levels (RBS). The same evaluator collected all the participant's baseline measurements and the end of 8 weeks of intervention measurement of biochemical variables. Participants' blood samples at the baseline and the end of 8 weeks of training were collected. Blood sugar levels, High-density lipoprotein (HDL)- cholesterol, and Low-density Lipoprotein (LDL) were analyzed by the NABL certified laboratory. Blood pressure is measured using a Sphygmomanometer by a trained professional three times; it was estimated with a subsequent rest period, and their mean values were taken for analysis. Statistical analysis was performed once the data were collected, sample size calculation was based on a minimum predicted 15% change in fasting blood glucose levels and total cholesterol levels, a sample of 20 participants per group was expected to provide sufficient power (80%) to detect significant changes at the 5% of significance levels. However, this study recruited 26 participants to accommodate an attrition rate of 20%. As predicted, 2 participants in group A and 2 participants in group B withdrew from the study in the 2nd week and 4th week. The authors completed this study with 24 participants in each group.

## RESULT

Results were calculated using SPSS 20.0, and the demographic characteristics were displayed in Table I. The interventions were analyzed and demonstrated in Table II. It was shown that the critical value is  $p < 0.05$ . While comparing the Random blood sugar (RBS) values within the groups, they show significant differences. The calculated 't' value is 30.08 with SD (3.01), with a p-value of 0.459, in group A and the 't' value is 24.04 (2.33), with a p-value of 0.2156 for group B, which signifies there is a fewer chance of type I error. The observed effect size in comparing the group is 3.36, indicating that the difference between the average and  $\mu_0$  is significant. So, the p-value  $< \alpha$ ,  $H_0$  is rejected. When comparing the groups, it was identified that group A shows more significance than group B. While comparing the Systolic blood pressure (SBP) values within the groups, they show significant differences. The calculated 't' value is 40.27 (0.85), with a p-value of 0.254, in group A and the 't' value is 18.60 (1.17), with a p-value of 0.337 for group B signifies there is a fewer chance of type I error. The observed effect size in comparing the group is 5.09, indicating that the difference between the average and  $\mu_0$  is significant. So, the p-value  $< \alpha$ ,  $H_0$  is rejected. When comparing the groups, it was identified that group A shows more significance than group B. While comparing the High-density lipoproteins (HDL) values within the groups, they show significant differences. The calculated 't' value is 12.89 (1.38), with a p-value of 0.125, in group A and the 't' value is 9.33 (0.995), with a p-value of 0.075 for group B signifies there is a fewer chance of type I error. The observed effect size in comparing the group is 2.05, indicating that the difference between the average and  $\mu_0$  is significant. So, the p-value  $< \alpha$ ,  $H_0$  is rejected. When comparing the groups, it was identified that group A shows more effectiveness than group B. While comparing the Low-density lipoproteins (LDL) values within the groups, they show significant differences. The



**Nandakumar et al.,**

calculated 't' value is 23.02 (1.13), with a p-value of 0.215, in group A and the 't' value is 17.84 (0.69), with a p-value of 0.336 for group B signifies there is a fewer chance of type I error. The observed effect size in comparing the group is 3.65, indicating that the difference between the average and  $\mu_0$  is significant. So, the p-value  $< \alpha$ ,  $H_0$  is rejected. When comparing the groups, it was identified that group A shows more significance than group B. Based on the analysis, this study's findings show that the magnitude of the differences between the average is  $\mu_0$  significant, which means there is an incredible difference between the interventions.

## DISCUSSION

The purpose of the study was to identify the effect of plyometrics on various biochemical variables in obese adults. Obesity is a complex disease that involves the accumulation of excess fat in the body [27]. Obesity causes multiple metabolic syndromes such as high blood pressure, atherosclerosis, diabetes, heart diseases, and some form of cancers [28]. Management of obesity includes physical activity and diet [29]. Physical activity is essential in managing weight; it impacts body weight and composition [30]. This study compares plyometric exercises with aerobic exercises on various biochemical variables like systolic blood pressure, random blood sugar levels, High-density lipoproteins, and Low-density lipoproteins. Studies supported a reduction of systolic blood pressure of 4.1mm hg following resistance training interventions [31]. Lewington has identified a decrease of 2mm hg, preventing stroke mortality by around 10% and heart disease by 7% [32]. Resistance exercises control the SBP by increasing nitric oxide levels in the central and peripheral areas by increasing blood flow and reducing the inflammatory markers and autonomic regulations [33,34,35]. Plyometrics has a profound impact on the changes in cholesterol levels. There is an increase of lecithin-cholesterol acyltrans (LCAT), the enzyme responsible for the transfer of the HDL cholesterol level, and it is increased following exercises [36]. There is a notable increase in lipoprotein lipase activity, which is rapidly following resistance exercises [37]. Few meta-analyses strongly support the resistance exercises reduce the total cholesterol levels, LDL & HDL [38,39]. A study by Tomeleri et al., 2016 shows that HDL-C is increased by 13.2% following 8 weeks of resistance exercises [40]. Plyometrics cause skeletal muscles energy substrates that originate from either glucose or triglyceride compounds [41]. There is a breakdown of glycogen which is increased. either by utilizing the type II muscle fibers with an increase in glycogen synthesis. There is glycogen depletion, and a reduction of blood glucose levels in the blood is identified [42]. Application of this form of exercise increases muscle mass. It suggests an enhanced number of mitochondria, which improves the ability of the muscles to oxidize substrates and thus reduces plasma glucose concentrations [43].

Aerobic exercises have also been found to improve insulin sensitivity, glucose concentration, and the concomitants of physical fitness among individuals with diabetes [44]; aerobic exercises also reduce blood pressure. A recent meta-analysis has shown a marked reduction of 8mm hg of systolic and 5mm Hg of the diastolic following regular exercises [45]. Reduction of blood pressure is not apparent following aerobic exercises; however, the hypothesis is that there is an antihypertensive mechanism that affects the beta-blockers, which reduces the blood pressure [46,47]. There is a blockage of the calcium channel blockers, and diuretics reduce the blood pressure [48]. Regular aerobic exercise modestly increases HDL levels [49]. Durstine 2001, identified that a minimum exercise might help in developing the HDL levels [50]. There is a modest elevation in the HDL levels following aerobic exercises, demonstrated by various meta-analyses [51]; they identified that a minimum of 1.2mg/dL to 1.9 mg/dL is elevated following exercises [52]. This study has significance in comparing plyometrics, which corresponds to aerobic exercises. Group A, who underwent plyometrics, produces a significant reduction in SBP, RBS, and LDL, whereas there is an increase in HDL levels. These changes are more profound in group A when compared with group B. This study concluded that a significant difference was obtained between the plyometric exercises and aerobic exercises on various biochemical variables. It also identified that the Plyometric exercises are more superior in reducing the SBP, RBS, LDL and improving HDL levels compared with aerobic exercises.





**Nandakumar et al.,**

## ACKNOWLEDGEMENT

The authors would like to thank Management of Shree Venkateshwara college of Paramedical sciences, Gopichettipalyam, Erode, Tamil Nadu, for their logistic support and technical support in conducting this study.

**Financial support and Sponsorship:** Nil

**Conflict of Interest** : There are no conflicts of interest.

## REFERENCES

1. Pradeepa R, Anjana RM, Joshi SR, Bhansali A, Deepa M, et al., ICMR-INDIAB Collaborative Study Group. Prevalence of generalized & abdominal obesity in urban & rural India--the ICMR-INDIAB Study (Phase-I) [ICMR- NDIAB-3]. Indian J Med Res. 2015 Aug;142(2):139-50.
2. Ahiwar R, Mondal PR. Diabetes and Metabolic syndrome. Clinical review and research. 2019; 13: 318—321.
3. Das M, Bose K. Presence of high rates of overweight and obesity among adult Marwaris of Howrah, West Bengal, India. Coll Antropol 2006;30(1):81-86.
4. Hruby A, Hu FB. The Epidemiology of Obesity: A Big Picture. Pharmacoeconomics. 2015;33(7):673-689.
5. Gallagher D, Heymsfield SB, Heo M, Jebb SA, Murgatroyd PR, Sakamoto Y. Healthy percentage body fat ranges: an approach for developing guidelines based on body mass index. Am J Clin Nutr. 2000;72(3):694-701.
6. Flegal KM, Kit BK, Orpana H, Graubard BI. Association of all-cause mortality with overweight and obesity using standard body mass index categories: a systematic review and meta-analysis. JAMA. 2013; 309: 71-82
7. Swain S. & Chowdhury S. Trends of nutritional status among rural adults in six states of India: findings from national survey data. Clin. Epidemiol. Glob. Heal. 2018; 6: 181-187.
8. Guo, S.S., W. Wu, W.C. Chumlea, and A.F. Roche. Predicting overweight and obesity in adulthood from body mass index values in childhood and adolescence. The American Journal of Clinical Nutrition.2002; 76: 653-658.
9. Ferreira, I., J.W.R. Twisk, W. van Mechelen, H.C.G. Kemper, J.C. Seidell, and C.D.A. Stehouwer. Current and adolescent body fatness and fat distribution: Relationships with carotid intima-media thickness and large artery stiffness at the age of 36 years. Journal of Hypertension.2004; 22: 145-155.
10. Engin, A. The Definition and Prevalence of Obesity and Metabolic Syndrome. Advances in Experimental Medicine and Biology, 2017: 1-17.
11. Blüher, M. The distinction of metabolically “healthy” from “unhealthy” obese individuals. Current Opinion in Lipidology.2010; 21: 38-43.
12. Rey-López, J.P., L.F. de Rezende, M. Pastor-Valero, and B.H. Tess. The prevalence of metabolically healthy obesity: A systematic review and critical evaluation of the definitions used. Obesity Reviews: An Official Journal of the International Association for the Study of Obesity.2014; 15: 781-790.
13. Bardia A, Holtan SG, Slezak JM, Thompson WG. Diagnosis of obesity by primary care physicians and impact on obesity management. Mayo Clin Proc. 2007;82(8):927-932.
14. Bleich SN, Pickett-Blakely O, Cooper LA. Physician practice patterns of obesity diagnosis and weight-related counselling. Patient Educ Couns. 2011;82(1):123-129.
15. Niemi GM, Rewane A, Algotar AM. Exercise and Fitness Effect On Obesity. [Updated 2021 Jun 8]. In: StatPearls [Internet]. Treasure Island (FL): StatPearls Publishing; 2021 Jan-. Available from: <https://www.ncbi.nlm.nih.gov/books/NBK539893/>
16. Donnelly JE, Honas JJ, Smith BK, et al. Aerobic exercise alone results in clinically significant weight loss for men and women: mid-west exercise trial 2. Obesity (Silver Spring). 2013;21(3):E219-E228.
17. Suman C. Aerobic exercise programme and reduction in body weight and body mass index (BMI). Galore International Journal of Health Sciences & Research. 2016; 1(1): 41-44.
18. Jakicic JM, Powell KE, Campbell WW, Dipietro L, Pate RR, Pescatello LS, et al. Physical activity and the prevention of weight gain in adults: a systematic review. Med Sci Sports Exerc. 2019;51:1262-9.



**Nandakumar et al.,**

19. Wilson JM, Marin PJ, Rhea MR, Wilson SM, Loenneke JP, Anderson JC. Concurrent training: a meta-analysis examining interference of aerobic and resistance exercises. *J Strength Cond Res* 2012;26:2293-2307.
20. Brellenthin AG, Lee D-c, Bennie JA, Sui X, Blair SN. Resistance exercise, alone and in combination with aerobic exercise, and obesity in Dallas, Texas, US: A prospective cohort study. *PLoS Med*.2021; 18(6)
21. Bennie JA, De Cocker K, Pavey T, Stamatakis E, Biddle SJ, Ding D, Muscle strengthening, aerobic exercise, and obesity: a pooled analysis of 1.7 million US adults. *Obesity*, 2020; 28 :371-378
22. Kotzamanidis, C. Effect of plyometric training on running performance and vertical jumping in prepubertal boys. *J Strength Cond Res* 20: 441–445, 2006.
23. Shah, S. Plyometric exercises. *Int J Health Sci Res*.2012; 2: 115–126.
24. Jebaraj FA, Alexander CR, Effect of plyometric and aerobic exercise on obesity among school students. *IJPESH*. 2016; 3(2): 83-85.
25. Myer, G., Ford, K., Palumbo, J., Hewitt, T. Neuromuscular training improves performance and lower extremity biomechanics in female athletes. *J. Strength. Cond Res*. 2005; 19(1): 51-60.
26. Ho, S.S., Dhaliwal, S.S., Hills, A.P. The effect of 12 weeks of aerobic, resistance or combination exercise training on cardiovascular risk factors in the overweight and obese in a randomized trial. *BMC Public Health*.2012; 12: 704.
27. Kelley GA, Kelley KS: Impact of progressive resistance training on lipids and lipoproteins in adults: A meta-analysis of randomized controlled trials. *Preventive Medicine*. 2009, 48: 9-19.
28. Djalalinia S, Qorbani M, Peykari N, Kelishadi R. Health impacts of Obesity. *Pak J Med Sci*. 2015;31(1):239-242.
29. Jensen MD, Ryan DH, Apovian CM, Ard JD, Comuzzie AG, Donato KA, Hu FB, Hubbard VS, Jakicic JM, Kushner RF, Loria CM, Millen BE, Nonas CA, Pi-Sunyer FX, Stevens J, Stevens VJ, Wadden TA, Wolfe BM, Yanovski SZ; American College of Cardiology/American Heart Association Task Force on Practice Guidelines; Obesity Society. 2013 AHA/ACC/TOS guideline for the management of overweight and obesity in adults: a report of the American College of Cardiology/American Heart Association Task Force on Practice Guidelines and The Obesity Society. *J Am Coll Cardiol*. 2014 Jul 1;63(25 Pt B):2985-3023.
30. Cameron N, Nichols JF, Hilll, PatrickK. Associations between physical activity and BMI, body fatness, and visceral adiposity in overweight or obese Latino and non-Latino adults. *Int J Obes*. 2017 :41: 873– 7
31. Cornelissen VA, Fagard RH, Coeckelberghs E, Vanhees L. Impact of resistance training on blood pressure and other cardiovascular risk factors: a meta-analysis of randomized, controlled trials. *Hypertension* 2011;58:950–8.
32. Lewington S, Clarke R, Qizilbash N, Peto R, Collins R; Prospective Studies Collaboration. Age-specific relevance of usual blood pressure to vascular mortality: a meta-analysis of individual data for one million adults in 61 prospective studies. *Lancet*. 2002 Dec 14;360(9349):1903-13.
33. Taylor AC, McCartney N, Kamath MV, Wiley RL. Isometric training lowers resting blood pressure and modulates autonomic control. *Med Sci Sports Exerc* 2003;35(2):251-6.
34. de Salles BF, Simão R, Fleck SJ, Dias I, Kraemer-Aguiar LG, Bouskela E. Effects of resistance training on cytokines. *Int J Sports Med*. 2010 Jul;31(7):441-50.
35. Phillips MD, Flynn MG, McFarlin BK, Stewart LK, Timmerman KL. Resistance training at eight-repetition maximum reduces the inflammatory milieu in elderly women. *Med Sci Sports Exerc* 2010;42(2):314-25
36. Calabresi L, Franceschini G. Lecithin:cholesterol acyltransferase, high-density lipoproteins, and athero-protection in humans. *Trends Cardiovasc Med*. 2010;20(2):50–53
37. Harrison M, Moyna NM, Zderic TW, et al. Lipoprotein particle distribution and skeletal muscle lipoprotein lipase activity after acute exercise. *Lipids Health Dis*. 2012;11:64.
38. Kelley GA, Kelley KS, Tran ZV. Walking, lipids, and lipoproteins: a meta-analysis of randomized controlled trials. *Prev Med* 2004;38:651- 661
39. Hsu CS, Chang ST, Nifor ON, Lee KJ, Lee SS, Liaw YP. Effects of Regular Aerobic Exercise and Resistance Training on High-Density Lipoprotein Cholesterol Levels in Taiwanese Adults. *Int. J. Environ. Res. Public Health* 2019, 16, 2003.
40. Tomeleri, C.M.; Ribeiro, A.S.; Souza, M.F.; Schiavoni, D.; Schoenfeld, B.J.; Venturini, D.; Barbosa, D.S.; Landucci, K.; Sardinha, L.B.; Cyrino, E.S. Resistance training improves inflammatory level, lipid and glycemic profiles in obese older women: A randomized controlled trial. *Exp. Gerontol*. 2016, 84, 80–87.
41. Mul JD, Stanford KI, Hirshman MF, Goodyear LJ. Exercise and regulation of carbohydrate metabolism. *Prog Mol Biol Transl Sci*. 2015;135:17–37.





## Nandakumar et al.,

42. Barillas SR, Watkins CM, Wong MA, et al. Repeated Plyometric Exercise Attenuates Blood Glucose in Healthy Adults. *Int J Exerc Sci.* 2017;10(7):1076-1084.
43. Akindede M, Buari M, Uloko A. Effects of plyometric exercise on concomitants of fitness and metabolic profile in type 2 diabetes patients. *International Journal of Physiotherapy*, 2016; 3(2), 208-213.
44. Larose J, Sigal RJ, Boulé NG, Wells GA, Prud'homme D, Fortier MS, Reid RD, Tulloch H, Coyle D, Phillips P, Jennings A, Khandwala F, Kenny GP. Effect of exercise training on physical fitness in type II diabetes mellitus. *Med Sci Sports Exerc.* 2010 Aug;42(8):1439-47.
45. Cornelissen VA, Buys R, Smart NA. Endurance exercise beneficially affects ambulatory blood pressure: a systematic review and meta-analysis. *J Hypertens.* 2013 Apr;31(4):639-48.
46. Martinez DG, Nicolau JC, Lage RL, Toschi-Dias E, de Matos LD, Alves MJ et al. Effects of long-term exercise training on autonomic control in myocardial infarction patients. *Hypertension* 2011; 58 (6): 1049–1056.
47. Nelson L, Jennings GL, Esler MD, Korner PI. Effect of changing levels of physical activity on blood-pressure and hemodynamics in essential hypertension. *Lancet* 1986; 2 (8505): 473–476.
48. Webb AJ, Rothwell PM. Effect of dose and combination of antihypertensives on interindividual blood pressure variability: a systematic review. *Stroke* 2011; 42 (10): 2860–2865.
49. Kodama S, Tanaka S, Saito K, Shu M, Sone Y, Onitake F, Suzuki E, Shimano H, Yamamoto S, Kondo K, Ohashi Y, Yamada N, Sone H. Effect of aerobic exercise training on serum levels of high-density lipoprotein cholesterol: a meta-analysis. *Arch Intern Med.* 2007 May 28;167(10):999-1008.
50. Durstine JL, Grandjean P, Davis P, Ferguson M, Alderson M, DuBose K, Blood lipid and lipoprotein adaptations to exercise: a quantitative analysis. *Sports Med* 2001;31:1033- 1062
51. Halbert JA, Silagy CA, Finucane P, Withers RT, Hamdorf PA. Exercise training and blood lipids in hyperlipidemic and normolipidemic adults: a meta-analysis of randomized, controlled trials. *Eur J Clin Nutr* 1999;53:514- 522.
52. Kelly T, Yang W, Chen CS, Reynolds K, He J. Global burden of obesity in 2005 and projections to 2030. *Int J Obes (Lond).* 2008 Sep;32(9):1431-7.

Table I :Demographic Data

	Mean (S.D)	p value
Age	27.19 ± 3.86	0.007
Male	27.18 ± 3.64	0.004
Female	27.21 ± 4.51	0.005
Height	164.56 ± 14.37	0.006
Weight	98.61 ± 8.34	0.004
Hours of Sitting	8.35 ± 1.64	0.009

Table II: Analysis of the variables

Outcome	N	Plyometrics (Mean/SD)		Aerobics (Mean/SD)		Percentage of Change	Effect Size	P value	Unpaired 't' value
		Before	After	Before	After				
Random Blood Sugar	24	239.38 ± 6.65	148.83 ± 11.96	240.38 ± 8.36	184.46 ± 9.05	12.52%	6.14	0.459	11.64
HDL levels	24	49.04 ± 3.44	66.79 ± 4.82	49.88 ± 3.52	59.17 ± 2.10	24.65%	2.63	0.125	7.11
LDL levels	24	155.08 ± 2.93	128.83 ± 4.47	155.08 ± 2.83	142.71 ± 2.99	7.41%	4.76	0.215	12.64
SBP	24	154.29 ± 4.34	119.96 ± 1.08	156.00 ± 3.71	134.21 ± 3.81	15.82%	8.22	0.254	17.62





## Analysis of Mining the Data Streams using Adaptive Batch Weighted Based Hybrid Machine Learning Model for Handling the Concept Drift

S. Meera\* and M.Sasikala

Assistant Professor, Department of Computer Science (PG), PSGR Krishnammal College for Women, Coimbatore, Tamil Nadu, India.

Received: 22 Oct 2021

Revised: 16 Dec 2021

Accepted: 10 Jan 2022

### \*Address for Correspondence

**S. Meera**

Assistant Professor,  
Department of Computer Science (PG),  
PSGR Krishnammal College for Women,  
Coimbatore, Tamil Nadu, India.  
Email: meerakrishnammal123@gmail.com



This is an Open Access Journal / article distributed under the terms of the **Creative Commons Attribution License** (CC BY-NC-ND 3.0) which permits unrestricted use, distribution, and reproduction in any medium, provided the original work is properly cited. All rights reserved.

### ABSTRACT

This research paper suggests a new method to spot and process conceptual changes with an enhanced backup vector machine for in-depth learning for effective performance. This method has a clear theoretical inspiration and does not need the parameterization of complex parameters. After studying other tasks that support altering concepts and briefly describing an improved backup vector device, here describes a new method for window coordination and assesses it in three conceptual operational scenarios simulated on real-time text data. Experiments show that this method effectively selects the proper window size and leads to a low forecast error rate. Therefore, an adaptive batch-based machine learning model (ABWHML) was established based on the integration of performance detectors in development groups. The proposed ABWHML model includes classifiers such as advanced support vector machines and in-depth learning models for assessing the performance of conceptual operational classifiers.

**Keywords:** learning, development groups, ABWHML, Experiments

### INTRODUCTION

Extracting and analysing flow of information is important for numerous applications and this field of research has attracted a lot of attention over the last decade. Also, there are some unique challenges that endure to contest modern hardware and algorithmic solutions. Cases of such difficulties include unlimited size of objects entering the data stream, different speeds, and unfamiliar data features. The purpose of this study is to describe the main problems with algorithmic keys for flow withdrawals. In particular, it focuses on the general problem of the concept's operation. A broad conversation of conceptual operating concepts and unique information in flow mining is

38095



**Meera and Sasikala**

provided along with an important and in-depth analysis of the relevant literature. We also examine current issues related to the method of evaluating concept performance detectors, and acme issues such as the deficiency of a defined set and the effect of time dependence on concept performance detection. By revealing breaks in the present literature, this study provides endorsements for upcoming research that helps river disturbance and algorithms for detecting conceptual performance. Through the use of a multitude of different devices, networks and usual tasks such as transactions and cell phones, data is now generated at an almost constant and unlimited speed. Data that goes online sequentially and continuously is called a data stream. These streams are a latent source of numerical and qualitative data, provided they can be accessed in a judicious manner. Adaptive machine learning methods can be used to gather fascinating data from a stream in a procedure known as streaming analysis. However, the volume, speed, and timing of incoming data can be a trial for streaming data analysis. Distinct static data in typical batch training situations, streaming information can only be viewed once and is not limited in magnitude. This is an intrinsic issue in streaming and a trial for real-time dispensation. Concept drift is other intrinsic issue caused by the change or evolution of data transmission over the time. It also occurs with changing degrees of sternness. A change in the causal supply can reason the feature vectors of incoming cases to no longer reproduce the class label. This negatively affects the reliability and accuracy of the classifier predictions using the present distribution.

**LITERATURE SURVEY**

A global database is a virtual atmosphere where the generated data is available all over the world. As said by Reinselatal. The exponential development is owing in portion to hardware improvements and increased user retrieval. Literature and techniques, including unverified methods such as Seti and Kantarzc and de Melv at al not modified. It is different from existing releases like Gama et al. , this article reviews modern and new methods of managing conceptual operations and methods identified in previous studies. Dietzler et al. offers a summary of learning trials and methods to static and growing data flows. But his study lacks the detail and depth describe and instead, describe the technology. Likewise, a new review of Krawczyketal. The timing of this analysis is particular importance. Successful data flow extraction can potentially provide numerical and qualitative data.

The Hinckley test page (PHT) is a CUSUM change and can detect data variation effectively. This method detects data changes by passing a custom threshold value along with the input constraint. If the average of the new records exceeds the set threshold value, an eccentricity from notion alarm is activated. Also, distinct ADWIN, DDM and EDDM , it will not recognize the warning area. A descending window to detect conceptual performance in the data used by the Adaptive Wind Algorithm (ADWIN). ADWIN must be resized because the input data string is limited to. ADWIN draws a static window for detecting changes in incoming data. Every time two sub-windows show different objects in the new view, the oldest pane is excluded. This happens with the Hoeffding limit. An alert is activated to detect conceptual derivations from used-defined thresholds. If the complete change among the two media surpasses a predetermined threshold, a concept deviation detection warning is generated. Also, a warning is activated if the threshold is not surpassed but close to the value.

The Operation Deviation Detection Method (DDM) is a conceptual deviation technique grounded on the assumption (PAC). If the sample distribution is constant, the student error rate decreases as the number of samples increases. If the distribution of the sample is infinite, the error may be Bayesian error. The DDM detects an increase in of 4358 Smart City Error that surpasses the calculated threshold in 2021 and advices that concept operations have been discovered. A warning zone is detected, if the error rate is not exceeded, but it may occur in the future. Concept speed of conceptual deviations can be classified into one of three different ways. Sudden operation, gradual operation and frequent operation. Brzezinski and Stefanovski briefly label these types of conceptual operation. Sudden operation occurs when the original distribution is suddenly completely replaced by another, gradual operation occurs much more slowly, and repeated operation occurs when the previous concept returns after a while. The operation can also be described as an increase that contains a sharp mid-way change in the operation. For example: network sensors are degraded and less accurate.





### Meera and Sasikala

#### CONTRIBUTION OF PROPOSED RESEARCH

The difference among traditional techniques and data flow are discussed in Babcock et al. Transfer data items attain online. The system does not control over the order in which data items in or between data streams. The size of the data stream is potentially unlimited. As elements in the data stream are processed, they are either deleted or archived. It is not possible to retrieve easily unless it is stored explicit memory. These are reasons intended to help eliminate existing snags in the current study. This study provides a possible pathway for upcoming research gaps in the prevailing literature. This article is designed as follows. An outline of switching, its main variances from old batch learning, and design needs for switching algorithms. A section 3 emphasis on research break in prevailing procedures and classifies and criticizes prevailing conceptual operation detection methods. Section 4 discusses conceptual operation, its descriptions and algorithm requirements, and section 5 highlights the concept of time and discusses evaluation methods dependent. section 6 accomplishes the article with suggestions for further research.

#### PROPOSED METHODOLOGY

The goal is to implement a design that recognizes itself and adapts to changes in data over time. This study provides a new infrastructure for handling two main types of conceptual operation. Sudden and gradual change of data that has a definite property. Training samples are handled in batches of the same size. This new structure, called the ABWHML (Combined Machine Learning) model based on adaptive classification, is based on the integration of operation detectors into development groups. The proposed ABWHML model includes classifiers such as advanced support vector machines and deep learning models to evaluate the performance of the conceptual operational classifier.

#### Definition of Concept Drift

Assume that the data stream is a categorization where  $X$  is a vector belonging to the following resource space and  $y$  is a target variable belonging to a set of multiple classes. As data streams evolve, the distribution of data generated from a sequence of samples changes from time to time. A conceptual change between time and 1 is defined as

$$(1) \exists X: Pr_t(X, y) \neq Pr_{t+1}(X, y) \quad (1)$$

Where is the common probability distribution among the set of input variables  $X$  and the time of the target variable? Classification decisions are made according to the back probabilities of the classes whose back probabilities are expressed as classy given  $X$ .

$$Pr(y|X) = \frac{Pr(y)Pr(X|y)}{Pr(X)} \quad (2)$$

where represents the former probability of the class,  $Pr(X | y)$  represents the class-dependent probability density function of the given class  $X$ , and  $PrX = k = 1nPrkPr(X | yk)$ .

#### Prequential Error

Object sequence  $(X_i, y_i)$  where  $i = 1, 2$ , the object is used to exam the design before training and the error is intended grounded on the sum of the accumulated loss functions. Among the predicted and observed values are

$$p_i = \frac{1}{i} \sum_{k=1}^i L(y_k, \hat{y}_k) \quad (3)$$

This prediction error is called as a sequence error or prediction error. In fact, the previous error of the sequential learning algorithm decreases and becomes the optimal error as the probability of training cases increases when the distribution of the input data is fixed. If there is an increase in error rate after examining a large enough cases, it means that the inference hypothesis is unreliable because the distribution of the input data is not fixed. These characteristics of previous failures are fundamental for the implementation of the proposed deviation detection





**Meera and Sasikala**

method. Thereby we study the conceptual operational problem for pattern recognition problems in the following structures. Each example contains a function vector and a tag that indicates the ranking. Data are obtained gradually in batches. Without losing the whole, these categories are considered to be of the same size, each containing m Example:

$$\vec{z}_{(1,1)}, \dots, \vec{z}_{(1,m)}, \vec{z}_{(2,1)}, \dots, \vec{z}_{(2,m)}, \vec{z}_{(t,1)}, \dots, \vec{z}_{(t,m)}, \vec{z}_{(t+1,1)}, \dots, \vec{z}_{(t+1,m)} \quad (4)$$

$\vec{z}_{(i,j)}$  denotes the j-th example of batch i. For each category, the data is distributed independently equal to the  $Pri(x, y)$  distribution. Depending on the extent and type of conceptual deviation, the sample distributions  $Pri(x, y)$  and  $Pri(x+1, y)$  vary between different numbers. Student L's goal is to predict the labels for the next category in a row. For example, after lot t, the student can predict the labels of lot t+1 using a subset of instructional examples from lot 1 to t. The student's goal is to minimize the cumulative amount of prediction errors. Changed concepts in machine learning are often used in fixed or consistent time windows of training data or weighted data or parts of hypotheses, depending on age and/or usefulness of classification tasks. The last approach in the weighted example has been used already to filter information in the relevant feedback method. In this work, we examine the first approach to maintaining an adjustable sized window. You can find detailed descriptions of the techniques described above and other methods. Selecting a Good "window size for a fixed-size window is a cooperation among fast compatibility (small windows) and good generalization of steps without conceptual changes (large windows). Current conceptual operational scope The task of learning the concept of operation or time shift has also been calculated in computer learning theory. Although it is impossible to learn a changing concept if there are no restrictions on the type of conceptual change that is acceptable, operating concepts have proven to be teachable (at least for a certain concept class) when the operating speed is particularly limited.

**Adaptive Batch Weighted based hybrid machine learning (ABWHML)**

The research study work introduces change detectors in the growing set of classifiers. Variation detectors are suitable for data that fluctuates naturally. Sets, on the other side, easily familiarize to gradual changes, but can slow down in response to sudden deviations. Thus, the mixture of two reinforced support vector machines (ISVM) and deep learning models can create a set that is suitable for the two main types of change. This set also does not create a new classification for sustainable conceptual categories. Batch drift detection methods are included in the batch weight group. If the dataset is empty, BWE will create a new classifier on the existing dataset. Otherwise, BWF initiates a BDDM to track the trend of the current. If BDDM indicates a warning level, a new category is created in the category and supplementary to the set. As the detector signal moves, a new classification is recreated on the handle and added to the set. Then, the heft of each constituent category is determined. Finally, BWE removes all parent classifiers if their weight is zero. An extended version of the BWE framework creates 10 default classifications on the Bootstrap instance that are created from the most recent set of data if the size is zero. The category-based blended learning process (ABWHML) is described in the following sections..

This study offers a new technique for detecting and manipulating conceptual variations with an enhanced deep learning support vector machine for effective performance. After studying other data for variation to changing concepts and briefly explaining an improved support vector machine, this method describes a new method of window fitting in three conceptual operational scenarios simulated on textual data. Real evaluates. Experiments have shown that this method effectually picks the suitable window size and reduces the amount of prediction error.

**Improved Support Vector Machine (ISVM)**

The window setting method labeled in this paper uses a backup vector machine as its main learning algorithm. Support vector machines are grounded on the principle of minimizing structural risk in statistical learning concept. In its original form, the SVM learns linear decision-making rules.

$$h(\vec{x}) = \text{sign}(\vec{w} \cdot \vec{x} + b) = \begin{cases} +1, & \text{if } \vec{w} \cdot \vec{x} + b > 0 \\ -1, & \text{else} \end{cases} \quad (5)$$





### Meera and Sasikala

The idea is to minimize the structural risk of finding hypothesis  $H$  that can be guaranteed with a minimum probability of error. For SVM, this shows that this aim can be interpreted into finding the hyperplane with the maximum smooth margin. Figuring this hyperplane is corresponding to resolving the subsequent optimization problem:

#### Optimization Problem 1 (SVM (primal))

$$\text{minimize: } V(\vec{w}, b, \xi) = \frac{1}{2} \vec{w} \cdot \vec{w} + C \sum_{i=1}^n \xi_i \quad (6)$$

$$\text{subject to: } \begin{cases} \forall_{i=1}^n y_i [\vec{w} \cdot \vec{x}_i + b] \geq 1 - \xi_i \\ \forall_{i=1}^n \xi_i > 0 \end{cases} \quad (7)$$

In this optimization issue, the Euclidean extent of the weight direction with reverse reaction is proportionate to the flattening boundary of the decision law. The (7) restraint needs that all instructional examples be aligned correctly to loosen slightly. If the training case is on the incorrect part of the "plane hyper, its equivalent is greater than or equal to 1. Therefore, it is a high limit on the training errors. Factor  $C$  in (6) versus training error Model complexity. For computational reasons, solving optimization issue 1 is useful instead of resolving optimization issue directly.

#### Optimization Problem 2 (SVM (dual))

$$\text{minimize: } W(\vec{\alpha}, ) = - \sum_{i=1}^n \alpha_i + \frac{1}{2} \sum_{i=1}^n \sum_{j=1}^n y_i y_j \alpha_i \alpha_j (\vec{x}_i \cdot \vec{x}_j) \quad (8)$$

$$\text{subject to: } \begin{cases} \sum_{i=1}^n y_i \alpha_i = 0 \\ \forall_{i=1}^n 0 \leq \alpha_i \leq C \end{cases} \quad (9)$$

Support vectors are those training examples  $\vec{x}_i$  with  $\xi_i > 0$  at the solution. From the solution of optimization problem 2 the decision rule can be computed,

$$\vec{w} \cdot \vec{x} = \sum_{i=1}^n \alpha_i y_i (\vec{x}_i \cdot \vec{x}) \quad (10)$$

To solve the problem of optimization 2 and apply the cultured decision law, it is enough to be able to calculate the point-by-point between resource vectors. He used this feature to familiarize the use of cores to study nonlinear decision rules. Depending on the main function, SVM teaches a polynomial classifier, a ht (RBF) radial polarization function classifier, or a two-layer sigmoid neural network. These cores compute the point product in some resource sources and substitute the point product in the above formula.

#### Window Adjustment by Optimizing Performance

To address deviations in sample distribution, this method uses the sample data window. This window must only contain examples Enough "in the sense of the current goal. Suppose the amount of operations increases over time, this window contains the latest training examples. I used a strategy, its disadvantages These include: resizing the window or using sophisticated exploratory methods. The fixed size of the window makes a strong assumption about how quickly concepts change. Exploratory methods can be adapted to different speeds and operating values, but contain many constraints that are hard to adjust. Here we offer a way to choose the right window size that does not require difficult parameters. The main clue is to pick the window size to reduce the simplification error that is estimated in the new example. We use a special form of to get a general error estimate. -Computing Estimation is an effective technique for estimating SVM performance.

#### Window adjustment using Deep Learning Algorithm

The window configuration algorithm should resolve the following transactions: Large windows gives students with a lot of training data and simplify well because the concepts have not changed. However, great window may contain outdated data that is no longer pertinent (or confusing) for your current purpose. Finding the correct size means changing the number and quality of training samples. To reply this, the window mounting procedure is used in the following cases: It is especially appreciated. In category t, we basically test different window sizes and take the SVM for each training set.







**Meera and Sasikala**

Here we present a DNN-based technique that uses a loaded automatic encoder (SAE) to classify conceptual operation to improve the projected scale. Figure 2. shows the structure of the DNN model. Parameters are derived as input to the input stage. In general, DNNs are made with 2 layers of SAE. This network consists of two concealed neuronal layers. Also, a softmax layer is joined along with the final hidden layer to do sorting work. Thus, the initial layer provides the classmark capabilities for application letters. Suppose  $N$  input vectors are considered for training the AE as  $\{x_{(1)}, x_{(2)}, \dots, x_{(N)}\}$ . The reformation of input is processed by training AE as:

$$x' = F_D(W', b'; f_E(W, b; x)),$$

which is represented as:

$$x' = F_{AE}(W, b, W', b'; x),$$

Deep learning optimizer (DL) has a predefined learning speed by default. In the practical case, however, the DL model is a non-arched problem. An application that calculates the learning rate to reach maximum classification performance to determine the actual learning rate for a DNN model. The main objective of this model is to avoid Adagrad's vulnerability by collecting the sharp drop in the learning rate generated by the previous squared gradient in the denominator. The current gradient of Adadelat handled in a limited period of time is used to measure the learning rate. The accelerator is applied considering previous updates, Adadelat apprise rules are given below:

The gradient  $E^{(t)}$  is computed.

$$E^{(t)} = \frac{\delta l(\hat{X}^{(t)})}{\delta \hat{X}^{(t)}} \quad (11)$$

$$= (1 - H) \odot (\hat{X}^{(t)} \cdot ((\hat{X}^{(t)})^T \cdot \hat{X}^{(t)} + \epsilon \times I)^{-0.5}) \quad (12)$$

The local average  $\tilde{G}^{(t)}$  of existing value is determined  $E^{(t)2}$ . New term accumulating updates are estimated (momentum: acceleration term)

$$Z^{(t)} = \rho \times Z^{(t-1)} + (1 - \rho) \times (W^{(t-1)})^2 \quad (13)$$

Finally, the update expression is applied below.

$$W^{(t)} = \frac{\sqrt{Z^{(t)} + \epsilon \times I}}{\alpha \sqrt{\tilde{G}^{(t)} + \epsilon \times I}} \odot E^{(t)} \quad (14)$$

Eventually, the idea of manipulation changed with the introduction of adaptive (ABWHML) hybrid machine learning. This technique unswervingly implements the area of neglecting irrelevant data to minimize generalization errors.  $W(t)$  - Controls a particular function in SVM to estimate problems with window size selection. This new technique is simpler to use in applications because it has fewer constraints than complex heuristics. Trials in data filtering displays that this projected new method achieves low error rates and picks suitable window sizes in very dissimilar conceptual diversity scenarios.

**EXPERIMENTAL RESULTS**

The experiments show that the approach effectively selects an appropriate window size and results in a low predictive error rate. Thence, Adaptive Batch Weighted based Hybrid Machine Learning (ABWHML) model, is developed based on incorporating drift detector into the evolving group. This proposed ABWHML model involves the classifiers like Improved Support Vector Machine and Deep Learning model for evaluating the performance of the classifier along with concept drift.

All experiments were carried out on 3 different data sets: elec2, hyperplane and STAGGER. Electricity is a real data set containing energy prices from the electricity market in the Australian state of New South Wales. These prices



**Meera and Sasikala**

were affected by market demand, supply, season, weather and time of day. From the original data set I selected only a time period with no missing values. Hyperplane is a popular generator that creates streams with gradual concept drift by rotating the decision boundary for each concept. STAGGER is a data generator that creates streams with sudden concept drift. In my data set sudden drift occurs in every 10000 examples. Detailed characteristics of this datasets are given in Table 1. The experimental setup is performed along parameters like Accuracy, Memory size and time consumption. Figure 3,4,5 explores the sample result attained in STAGGER dataset samples taken for proposed methodology Adaptive Batch Weighted based Hybrid Machine Learning against prevailing methodologies as simple Batch Weight Ensemble (BWE) and Batch Weight Ensemble with Bootstrapping(BWE+BS).

**CONCLUSION**

The unexploited data streams source in either quantitative or qualitative information enhances profit and efficiency in all sectors. As concluding, proposed research results in optimised performance accordingly with high accuracy, low costs, less time consumption and memory consumption. The existing methodology enjoys the slight advantage over other algorithms in terms of accuracy. Unfortunately, it is also the costliest strategy in terms of processing time, as it requires estimating each component's predictive performance after each instance. Experiments show that this method effectively selects the proper window size and leads to a low forecast error rate. this method is explored for window coordination and assesses it in three conceptual operational scenarios simulated on real-time text data. Thence, Adaptive Batch Weighted based Hybrid Machine Learning (ABWHML) model incorporating improved support vector machines and Deep Learning for efficient performance without complicated parameter tuning.

**REFERENCES**

1. Charu C Aggarwal, Jiawei Han, Jianyong Wang, and Philip S Yu. A framework for clustering evolving data streams. In Proceedings of the 29th International Conference on Very Large Data Bases-Volume 29, pages 81–92. VLDB Endowment, 2003.
2. Dana Angluin. Queries and concept learning. *Machine Learning*, 2(4):319–342, 1988.
3. Brian Babcock, Mayur Datar, and Rajeev Motwani. Sampling from a moving window over streaming data. In Proceedings of the Thirteenth Annual ACM-SIAM Symposium on Discrete Algorithms, pages 633–634. Society for Industrial and Applied Mathematics, 2002.
4. Manuel Baena-García, José del Campo-Avila, Raúl Fidalgo, Albert Bifet, Ricard Gavaldà, and R Morales-Bueno. Early drift detection method. In Fourth International Workshop on Knowledge Discovery from Data Streams, volume 6, pages 77–86, 2006.
5. Peter L Bartlett, Shai Ben-David, and Sanjeev R Kulkarni. Learning changing concepts by exploiting the structure of change. *Machine Learning*, 41(2): 153–174, 2000.
6. Bifet, J. Gama, M. Pechenizkiy, and I. Zliobaite. Handling concept drift: Importance, challenges and solutions. PAKDD-2011 Tutorial, Shenzhen, China, 2011.
7. Albert Bifet and Ricard Gavaldà. Adaptive learning from evolving data streams. In *Advances in Intelligent Data Analysis VIII*, pages 249–260. Springer, 2009.
8. Albert Bifet, Geoff Holmes, Richard Kirkby, and Bernhard Pfahringer. Moa: Massive online analysis. *The Journal of Machine Learning Research*, 11: 1601–1604, 2010a.
9. Albert Bifet, Geoff Holmes, and Bernhard Pfahringer. Leveraging bagging for evolving data streams. In *Machine Learning and Knowledge Discovery in Databases*, pages 135–150. Springer, 2010b.
10. R.P. Jagadeesh Chandra Bose, Wil M.P. van der Aalst, Indre Zliobaite, and Mykola Pechenizkiy. Handling concept drift in process mining. In Haralambos Mouratidis and Colette Rolland, editors, *Advanced Information Systems Engineering*, volume 6741 of *Lecture Notes in Computer Science*, pages 391–405. Springer Berlin Heidelberg, 2011. ISBN 978-3-642-21639-8. doi: 10.1007/978-3-642-21640-4\_30.



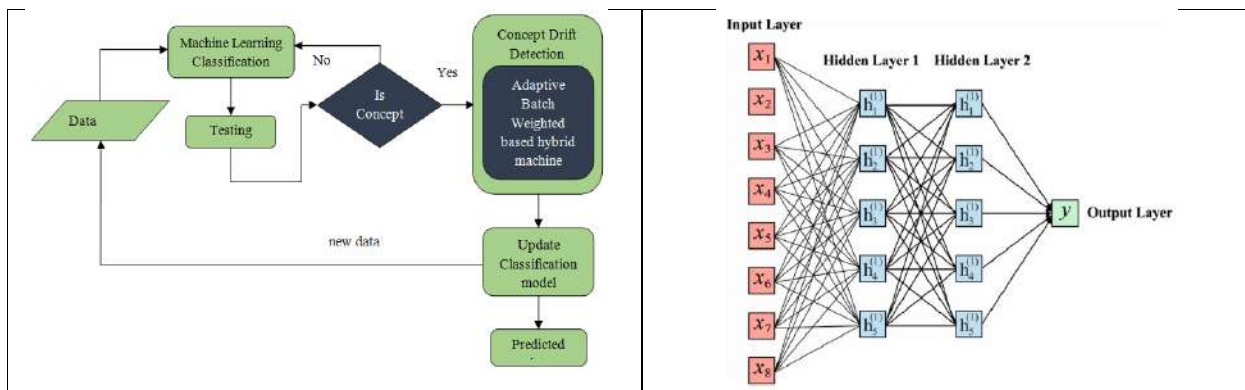


**Meera and Sasikala**

11. D. Brzezinski and J. Stefanowski. Reacting to different types of concept drift: The accuracy updated ensemble algorithm. *Neural Networks and Learning Systems, IEEE Transactions on*, 25(1):81–94, Jan 2014a. ISSN 2162-237X. doi: 10.1109/TNNLS.2013.2251352.
12. Dariusz Brzeziński. Mining data streams with concept drift. Master’s thesis, Poznan University of Technology, 2010.
13. F. Fdez-Riverola, E. L. Iglesias, F. D’iaz, J. R. M’endez, J. M. Corchado, Applying lazy learning algorithms to tackle concept drift in spam filtering, *Expert Systems with Applications* 33 (1) (2007) 36–48., URL <http://dx.doi.org/10.1016/j.eswa.2006.04.011>
14. C.-J. Tsai, C.-I. Lee, W.-P. Yang, Mining decision rules on data streams in the presence of concept drifts, *Expert Systems with Applications* 36 (2, Part 1) (2009) 1164–1178. URL <http://dx.doi.org/10.1016/j.eswa.2007.11.034>
15. J. Z. Kolter, M. A. Maloof, Dynamic weighted majority: An ensemble method for drifting concepts, *Journal of Machine Learning Research* 8 (2007) 2755–2790.

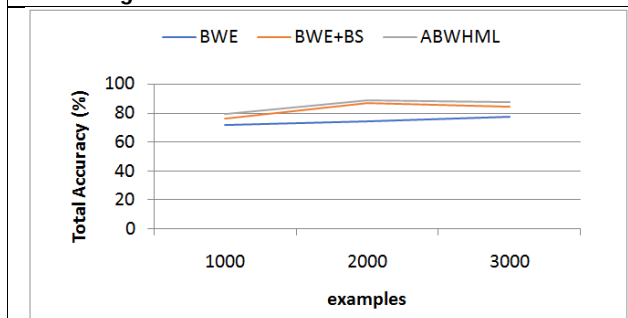
**Table 1. Characteristics of data sets**

Dataset	Objects	Attributes	Classes
elec2	27600	6	2
Hyperplane	32000	10	2
STAGGER	32000	3	2

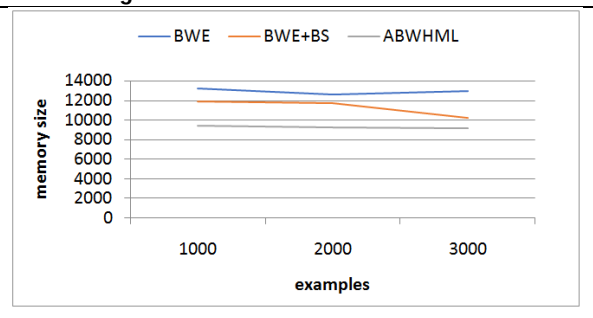


**Figure 1. Architecture of ABWHML model**

**Figure 2 The basic structure of DNN**



**Figure 3 Accuracy Classification results for Stagger dataset**

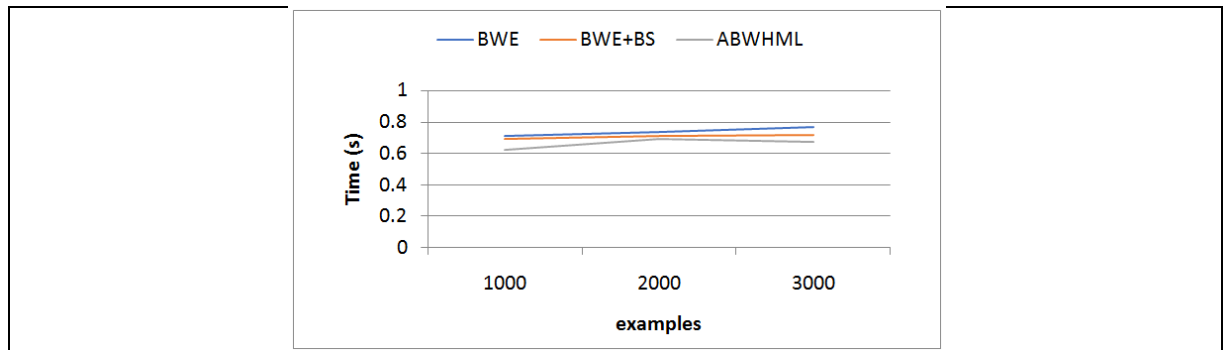


**Figure 4 Results of memory usage for Stagger dataset**





**Meera and Sasikala**



**Figure 5 Results of Processing time for Stagger dataset**





## A Study on Physico-Chemical Parameters and Water Quality Index (WQI) of Varuna Lake, Mysore, Karnataka, India

H. R. Abhilash<sup>1</sup> and M. Mahadevaswamy<sup>2\*</sup>

<sup>1</sup>Research Scholar, Department of Zoology, Yuvaraja's College (Autonomous), University of Mysore, Mysore -570005, Karnataka, India.

<sup>2</sup>Professor of Zoology, Department of Zoology, Yuvaraja's College (Autonomous), University of Mysore, Mysore - 570005, Karnataka, India.

Received: 09 Nov 2021

Revised: 15 Dec 2021

Accepted: 11 Jan 2022

### \*Address for Correspondence

#### M. Mahadevaswamy

Professor of Zoology,  
Department of Zoology,  
Yuvaraja's College (Autonomous), University of Mysore,  
Mysore - 570005, Karnataka, India.  
Email: maadhuycm@gmail.com



This is an Open Access Journal / article distributed under the terms of the **Creative Commons Attribution License** (CC BY-NC-ND 3.0) which permits unrestricted use, distribution, and reproduction in any medium, provided the original work is properly cited. All rights reserved.

### ABSTRACT

Water is the most vital and necessary item for all life forms. The quality of freshwater resources is greatly impacted by anthropogenic activities especially those in the urban vicinities, which are frequently utilized as dumping stations for urban sewage. The Varuna Lake is located on the outskirts of Mysore city and is undergoing rapid transformation as several residential projects are springing up in the vicinity. This study aims to determine the physico-chemical quality of Varuna Lake water. The study period was divided into three seasons: post-monsoon (October-January), pre-monsoon (February-May) and monsoon (June-September) seasons. Surface water samples from three locations were collected and various water quality parameters were analyzed following standard methods. The mean values of all parameters were compared with drinking water quality standard given by BIS and ICMR. The data was statistically treated using one way ANOVA to find out seasonal variation in different water quality parameters. Pearson correlation analysis was performed to analyze relationship between water quality variables. There was a significant seasonal variation in some of the physico-chemical parameters as revealed by high values of pH, conductivity, turbidity, chemical oxygen demand and biological oxygen demand during pre-monsoon season. From the correlation analysis conductivity was found to have a positive relationship with water temperature and total dissolved solids. Most of the water quality parameters had a substantial negative correlation with pH. The overall WQI index was 80.27, which indicates poor water quality. The lake water was found to be more polluted than previous studies on the same lake.

**Keywords:** Varuna Lake, seasonal variation, water quality, water quality index (WQI).



**Abhilash and Mahadevaswamy****INTRODUCTION**

Fresh water ecosystems are more vulnerable to degradation than their terrestrial or marine counterparts [1]. Since the beginning of civilization, man has used aquatic resources for various purposes such as agriculture, hydropower, industries, fisheries, municipal supplies, recreational use and have put severe strain on water bodies by dumping untreated sewage, industrial, and technical wastes, in the hopes that a massive column of water, through dilution and the action of numerous detoxifying agents, would render the toxic substances harmless [2, 3]. India, like many other countries throughout the world, is facing severe crises of water shortages and pollution issues on a vast scale as a result of fast growing cities, flourishing industry, and an increase in its population [4]. Studies have shown that increase in anthropogenic activities in and around water bodies harms aquatic ecosystems and exacerbates environmental issues [5-7]. Therefore, regular monitoring of physicochemical properties of a water body is critical for both long and short term studies [8]. There are several methods to analyze water quality data that vary depending on informational goals, the type of samples, and the size of the sampling area [9]. Physico-chemical analysis is the most significant aspect when assessing the quality of water for its best utilization like drinking, irrigation, fisheries, and industrial purpose and helpful in understanding the complex processes, interaction between the climatic and biological processes in the water [10]. Furthermore, the data obtained from physicochemical properties can be used to calculate the water quality index (WQI). The WQI can condense a large amount of data to a single number, allowing it to express data in a more logical and simplified form, and also reveal annual cycles, spatial and temporal variation, and trends in water quality at low concentrations [11].

Several studies have been undertaken in Mysore city to assess water quality of freshwater lakes using water quality index. Mahesha and Balasubramanian [12] studied the impact of urbanization and industrialization on the water quality of Dalvoy Lake and found out that the WQI was 47.72 during pre-monsoon and 42.75 in post-monsoon and suggested that the lake water was suitable for agriculture purpose. However, when the same lake was studied six years later by Upadhyay and Chandrakala [13], it was found out that the lake was heavily impacted by untreated urban sewage which resulted in higher water quality index value of 158, these results shows the continuing deterioration of urban water bodies. In another study the WQI of Kukkarahalli Lake was studied by Mamatha [14] and reported that lake water quality was very poor with a WQI of 81.09. Similarly the WQI and abundance of zooplanktons in three contrasting lakes (Varuna, Madappa and Giribetta) of Mysore district was undertaken by Deepthi and Yamakanamardi [15] and they reported that Varuna Lake was moderately polluted (WQI-69), while Madappa and Giribetta lakes were severely polluted with a WQI of 83 and 93 respectively. In the current investigation an attempt is made to evaluate the water quality of Varuna Lake. The main aim of this study was to describe the seasonal variation of physico-chemical parameters and to investigate causes and factors which are responsible for such variation. Furthermore, to compute water quality index (WQI) in order to determine the overall quality of the lake from a pollution standpoint.

**MATERIALS AND METHODS****Study area**

Varuna Lake is located 13.3km from Mysore district, Karnataka state, India (76°74'58.72" E latitude, 12°27'50.31" N, longitude and 719 meters above the mean sea level). The lake is adjacent to Mysore - Trichy road and it is surrounded by Varuna, Chikkalli and Varakodu village (Fig. 1). The lake is commercially used for water sports by Outback adventures. The surrounding areas of the lake have lately been developed into residential areas, making it a desirable real estate destination. The lake is connected to the Varuna canal, which delivers Cauvery water and serves as a primary source of water, and it is supplemented by rain and runoff from the surrounding watershed.

**Water sample collection and physico-chemical analysis**

Sampling was done monthly for 1 year (October 2017 – September 2018) from three sampling sites. Surface water samples were collected (between 8.00 am and 10.00 am) by dipping 1 L labeled polythene plastic bottles. Parameters





### Abhilash and Mahadevaswamy

like water temperature and pH were measured on site, using a mercury thermometer and Hanna HI98107 pH meter, respectively. Further analysis of various physico-chemical parameters such as dissolved oxygen, electrical conductivity, total dissolved solids, salinity, turbidity, free carbon dioxide, total alkalinity, total hardness, nitrate, phosphate, sulphate, chloride, biological oxygen demand (BOD) and chemical oxygen demand (COD) were carried out in the laboratory as per standard methods [16, 17]. The mean values of the measured parameters for each season were compared with BIS and ICMR standards and pollution status was determined using water quality index (WQI) method. Data on physico-chemical variables were subjected to one way ANOVA ( $p < 0.05$ ), and where significant difference existed, means were separated using Tukey's test. Pearson correlation analysis was also performed to establish whether there existed a relationship among the measured physicochemical water quality variables. This was calculated after  $\log_{10}$  transformation of all variables after scaling so that all values were  $>1$ . All the statistical analysis was performed using SPSS (version 16) software.

#### Water quality index computation

The water quality index was calculated using twelve parameters based on their importance in water quality analysis. These parameters are pH, conductivity, total dissolved solids, dissolved oxygen, calcium, hardness, total alkalinity, BOD, nitrate, sulphate, chloride and turbidity. The values used for each parameter were the mean value of each season investigated during the study period. The standards for drinking water used in this study are recommended by BIS and ICMR [18, 19]. The relative weights calculated for each parameter is shown in the Table 1. The calculation of WQI was performed by following the 'weighted arithmetic index method' as described by Brown et al. [20], using the equation:

$$WQI = \frac{\sum Q_n W_n}{\sum W_n}$$

Where  $Q_n$  is the quality rating of  $n^{\text{th}}$  water quality parameter,  $W_n$  is the unit weight of  $n^{\text{th}}$  water quality parameter.

The quality rating  $Q_n$  is calculated using the equation:

$$Q_n = 100[(V_n - V_i) / (S_n - V_i)]$$

Where  $V_n$  is the actual value of the parameter obtained,  $V_i$  represents the ideal value of that parameter. [ $V_i = 0$ , except for pH ( $V_i = 7$ ) and DO ( $V_i = 14.6$  mg/l)],

$S_n$  is the standard permissible value for the  $n^{\text{th}}$  water quality parameter.

Unit weight ( $W_n$ ) is calculated using the formula:

$$W_n = K/S_n$$

Where  $K$  is the constant of proportionality and it is calculated using the equation:

$$K = [1/\sum 1/V_s = 1, 2, \dots, n]$$

The water quality status (WQS) according to WQI is shown in Table 2.

## RESULTS AND DISCUSSION

**Physico-chemical parameters:** The mean values of surface water quality parameters of the Varuna Lake are grouped into three seasons, post-monsoon (October to January), pre-monsoon (February to May) and monsoon (June to September). The seasonal variation of different physico-chemical variables from October 2017 to September 2018 are shown in the Table 3. There was a statistically significant difference between seasons in water temperature ( $F(2, 9) = 7.96, p = .010$ ), COD ( $F(2, 9) = 8.88, p = .007$ ) and BOD ( $F(2, 9) = 7.25, p = .013$ ). As with rest of the parameters there was no significant difference between the seasons ( $p > 0.05$ ).

**Water temperature:** The water temperature values of Varuna Lake varied according to the seasonal rhythm, seasonally the highest average value of water temperature was observed during pre-monsoon season. As revealed by the Tukey's post hoc test there was significant difference in temperature b/w pre-monsoon and post-monsoon seasons ( $p = .007$ ), while there was no statistically significant difference between the post-monsoon vs monsoon ( $p = .188$ ) or between pre-monsoon vs monsoon ( $p = .151$ ). Water temperature is crucial because it strongly influence many physical and chemical characteristics of water including the solubility of oxygen and other gases, rates of chemical reaction, toxicity and microbial activity[22]. The highest temperature was recorded during pre-monsoon (30.73 °C)



**Abhilash and Mahadevaswamy**

which could be due to high solar radiation, clear atmosphere and low water level [23] and the lowest was recorded during post-monsoon season (26.92°C) which can be attributed to low ambient temperature.

**pH:** The pH defines the concentration of protonions (H<sup>+</sup>) found in the water. The optimal pH for drinking water is described in the range of 6.5 to 8.5 by BIS standards. The water was alkaline in nature throughout the year. According to Gupta et al., [24] when pH exceeds 8.5, the taste of water becomes more salty, causing eye discomfort and skin disorders. The average mean value of pH during the investigation was 8.18 during post-monsoon, 8.98 during pre-monsoon and 8.24 during monsoon. There was no significant difference in pH throughout the study period, which was in accord to the previous study in the same lake [15].

**Electrical conductivity:** Electrical conductivity (EC) is the ability of water to conduct electric current and is also a measure of total number of dissolved salts or ions [7]. The electrical conductivity in Varuna Lake was 250.67 µS during post-monsoon, 273.67µS during pre-monsoon season and 260.17 µS during monsoon season. Seasonal variations in conductivity especially in lakes where inflow of water is marginal the fluctuation primarily depends on temperature and evaporation[25]. The highest value of 273.67 µS during pre-monsoon corresponds with the highest water temperature recorded during the same season.

**Total dissolved solids:** The total dissolved solid (TDS) in water is a measurement of the combined contents of all inorganic and organic components present in water as molecules, ions, or micro-granular suspended forms[26]. The observed average total dissolved solids value was 139.5 mg /L during post-monsoon, 142.67 mg/L during pre-monsoon and 132 mg/L during monsoon season. The mean value of TDS was found below the prescribed limit (500 mg/L) of BIS, and there was no significant seasonal variation during the study period. Pearson correlation matrix revealed a strong connection between conductivity and TDS as revealed by correlation test ( $p < 0.01$ ). The highest conductivity (273.67 S/cm) and TDS (142.67 mg/L) values were found in the pre-monsoon period, which corresponds to a decrease in water levels, which is associated with an increase in dissolved solids concentration [25].

**Turbidity:** Turbidity is a function of light dispersing and absorbing properties of water caused by the occurrence of suspended matters like clay, silt, colloidal organic particles and plankton [27]. Suspended particles absorb heat which causes water temperature to increase and it holds less oxygen than cold-water [28]. In the present study, high turbidity was recorded during pre-monsoon season (8.12 NTU) which was slightly higher than the acceptable limit (5 NTU).

**Dissolved oxygen:** Dissolved oxygen is a critical measure in water quality assessment since it indicates whether or not a water body is polluted. The concentration of DO depends upon the water temperature, water agitation, types and number of aquatic plants, light penetration and amount of dissolved or suspended solids [7]. The mean values of DO recorded during the entire study period were well above the prescribed limit (5 mg/L) of BIS standards. The highest mean value of 5.4 mg/L was recorded during the monsoon season, while the lowest average (5.2 mg/L) was obtained during the post-monsoon and pre-monsoon seasons, which was slightly different from the monsoon season. Concentrations of less than 5 mg/L may disrupt the functioning and survival of biological communities, whereas concentrations of less than 2 mg/L may result in fish mortality [29].

**Free carbon dioxide:** Carbon dioxide in water is produced by the breakdown of organic materials and the respiratory activity of aquatic plants and animals [27]. In the present investigation the mean concentration of free carbon dioxide during the post-monsoon and monsoon seasons in the lake was less than 4 mg/L, and it was completely absent during the pre-monsoon season.

**Calcium:** Calcium is the most abundant divalent ion in fresh water and is necessary for shell formation, bone formation, and plant lime precipitation [30]. Calcium is found in all natural waters; however it is augmented by the discharge of various sewage and waste water [31]. The observed mean value of calcium was 22.20mg/L during post-monsoon, 16.49mg/L during pre-monsoon and 17.63mg/L during monsoon. The values recorded in all seasons were within the permissible limit (75mg/L) of BIS standards.





**Abhilash and Mahadevaswamy**

**Hardness:** Hardness of the water is a feature resulting from the presence of alkaline earth metals in natural waters, particularly calcium and magnesium [32]. The dissolution of soil minerals and rocks causes this feature, but it can also be induced by direct contamination by trash from a variety of anthropogenic sources [33]. Kannan [34] divided water into three categories based on hardness values: 0 – 60 mg/L soft, 61 – 120 mg/L moderately hard, 121–160 mg/L is hard, while greater than 180 mg/L as very hard. The highest concentration of hardness in the water sample was recorded during post-monsoon 101.83mg/L, which was well within the permissible limit (300mg/L) of the BIS standards. The results were parallel to the values reported previously for this lake [15].

**Alkalinity:** Alkalinity is a measure of the capacity of water to neutralize a strong acid [35]. Surface water alkalinity is predominantly determined by carbonate and hydroxide concentration, but also includes contributions from borates, phosphates, silicates, and other bases [36]. The highest alkalinity was recorded during pre-monsoon 107.5 mg/L and the lowest during monsoon (93.17mg/L) season. The low alkalinity value in surface waters during the monsoon was most likely due to rainwater dilution [29].

**Chemical oxygen demand (COD):** Chemical oxygen demand is a metric that accounts for both biologically oxidizable and chemically inert organic materials[30]. In the present investigation the highest amount was recorded during pre-monsoon season (42.93mg/L) which may be due to decrease in water level, increase in salinity, temperature and microbial utilization of oxygen during the time of decomposition [37]. The concentration of COD decreased during monsoon season probably because of inflow of rainwater, decreased temperature and salinity. Increased COD levels suggest a higher concentration of organic and inorganic pollutants that requires more oxygen to oxidize in thermal conditions [38]. The statistical data from ANOVA revealed a significant difference ( $p < 0.05$ ) among various seasons. Further, the Tukey post hoc test showed there was significant difference in COD between post-monsoon and pre-monsoon seasons ( $p = .011$ ) and pre-monsoon vs monsoon ( $p = .015$ ). There was no statistically significant difference between the post-monsoon vs monsoon ( $p = .89$ ).

**Biological oxygen demand:** BOD is the measure of quantity of oxygen required by bacteria and other microorganisms under aerobic condition in order to biochemically degrade and transform organic matter present in the water bodies [39]. It indicates the amount of perishable organic matter present in water. As a result, a low BOD indicates good water quality, whereas a high BOD suggests contaminated water [40]. The BOD of Varuna Lake was found within the permissible limit (5mg/L) of ICMR during the study period.

**Nitrate:** Nitrate is a vital nutrient that influences the productivity of aquatic ecosystems and speeds up the growth of algae and macrophytes [7]. Nitrates enter freshwater through the discharge of sewage and industrial wastes and run off from agricultural fields[41]. Nitrate value recorded in the study was 1.40mg/l during post-monsoon, 0.59mg/L during pre-monsoon and 1.68mg/L during monsoon season. The values recorded from all the seasons showed low concentration of nitrate, which was well within the permissible levels as per the standards.

**Phosphate:** Phosphate is an essential micronutrient for living organisms that is found in trace amounts in natural water bodies and is a major limiting factor that regulates primary productivity. Phosphate in natural waters is the result of the degradation of organic phosphorus contained in wastewaters by bacteria. Runoff from agricultural fields loaded with phosphate fertilizers can also introduce them in large quantities into the water bodies [42]. The concentration of phosphate measured in Varuna Lake was less than 0.1mg/L throughout the study period.

**Sulphate:** Sulphate is a common anion present in low concentration in natural waters. Sulphate sources in water bodies include rainfall run-off, fertilizers, sewage effluents, and dissolution of sulphide minerals present in granite [43]. The mean concentration of sulphate in the present investigation was found in the range of 4.9mg/L to 10.92mg/L, which was way below the acceptable range of BIS standards.



**Abhilash and Mahadevaswamy**

**Chloride:** Chloride occurs in all surface natural waters, but in very low concentration in freshwater bodies. The presence of a high chloride concentration is thought to be a sign of pollution caused by a large amount of organic waste from animal origin [31]. Chloride value obtained in the study was 21.47mg/L during post-monsoon, 30.40mg/L in pre-monsoon and 26.37mg/L in monsoon season. The chloride concentration in the Varuna Lake was found within the acceptable limit of 250mg/L.

**Correlation among physico-chemical variables**

Correlation matrix among the various physico-chemical parameters of Varuna Lake from October 2017 to September 2018 is represented in Table 4. The correlation analysis revealed that temperature was positively correlated ( $r = 0.790$ ,  $p < 0.01$ ) with electrical conductivity. Studies have shown that electrical conductivity depends on the amount and composition of ions and temperature [44, 45]. Similarly there was a strong positive correlation between TDS and EC ( $r = 0.718$ ,  $p < 0.01$ ), calcium and hardness ( $r = 0.761$ ,  $p < 0.01$ ), COD vs BOD ( $r = 0.961$ ,  $p < 0.01$ ). The results showed that TDS was positive correlated with hardness ( $r = 0.614$ ,  $p < 0.05$ ) and total alkalinity ( $r = 0.660$ ,  $p < 0.05$ ). Calcium and magnesium, which occur naturally in water bodies, are among the most highly available alkali metals in the environment responsible for the hardness in water [46]. The pH showed a negative correlation with calcium ( $r = -0.661$ ,  $p < 0.05$ ) and nitrate ( $r = -0.753$ ,  $p < 0.01$ ). Dadgar [47] discovered a clear inverse linear correlation between nitrate and water pH, where he showed that increasing nitrate levels in water causes pH values to decline.

**Water quality index (WQI)**

The summary of WQI values for all seasons are given in the Table 5. The calculated WQI implies that the lake water quality was “Poor” during post-monsoon and monsoon and “Unsuitable” during pre-monsoon season. The high WQI score during the Pre-monsoon season can be attributed to a higher pollution load during summer than during the rainy and winter seasons, which is also attributed by high conductivity, pH, and chloride concentrations [48]. Several workers have reported high water quality index during pre-monsoon seasons [15, 49, 29]. The overall WQI of Varuna Lake fell within the ‘very poor’ category of WQI classification and is not suitable for daily needs. These values were found to higher than what was previously reported (WQI- 69) by other workers in the same lake [15]. This indicates that the lake's water quality is steadily degrading over time. The major source of pollution was from agriculture runoff and domestic sewage inputs. Overall it can be concluded that the water quality of the lake Varuna is poor and needs to be treated before human usage; however it is suitable for agriculture and fisheries with proper treatment. The findings of this study may aid decision-makers in the sustainable management and protection of the lake.

**ACKNOWLEDGEMENT**

The authors are thankful to the Principal of Yuvaraja's College, Mysore for providing laboratory facilities. In addition the researchers want to appreciate the help of Dr.Goutham.S and Mr.Lokesh.D for their assistance during the field work.

**CONFLICT OF INTEREST**

The author(s) declares no conflict of interest.

**REFERENCES**

1. Dudgeon, D, Arthington, AH, Gessner, MO, Kawabata, ZI, Knowler, DJ, Lévêque, C, et.al. Freshwater biodiversity: importance, threats, status and conservation challenges. *Biol. Rev. Camb. Philos. Soc.*, 2006; 81(2): 163–182.
2. Jindal R, Sharma C. Studies on water quality of Sutlej River around Ludhiana with reference to physicochemical parameters. *Environ. Monit. Assess*, 2011; 174(4): 417–425.




**Abhilash and Mahadevaswamy**

3. Ramachandra MM. Water Quality Monitoring of Magadi Hill Range Lakes and Reservoirs of India. *Hydrology*, 2018; 6 (1): 18.
4. Rakhecha PR. Water environment pollution with its impact on human diseases in India. *Int. J. Hydrol*, 2020; 4(4)152–158.
5. Upadhyay P, Mishra, Gupta AK. Studies on the physico-chemical status of two ponds at Varanasi and Bhadohi under biotic stress. *Plant Arch*, 2010; 10 (2): 691–693.
6. Verma P, Purohit A, Patel N. Pollution Status of Chandlodia Lake Located In Ahmedabad- Gujarat. *Int J Eng Res Appl*, 2012; 2 (4): 1600–1606.
7. Bhat S, Mahesh M, Ramachandra TV. Assessment of Seasonal Variation in Water Quality and Water Quality Index (WQI) of Hebbal Lake, Bangalore, India. *J. Ecol. Environ*, 2019; 37: 309–317.
8. Wood A. Constructed wetlands in water pollution control: Fundamentals to their understanding. *Water Sci. Technol.*, 1995; 32 (3):21–29.
9. Alobaidy AHMJ, Abid HS, Maulood BK. Application of Water Quality Index for Assessment of Dokan Lake Ecosystem, Kurdistan Region, Iraq. *J. Water Resour. Prot*, 2010; 2 (9): 792–798.
10. Salve BS, Hiware CJ. Studies on water quality of Wanparkalpa reservoir, Nagapur, Near Parli Vaijnath, Dist Beed, Marathwada region. *J. Aquat. Biol*, 2006; 21 (2):113–117.
11. Tyagi S, Sharma B, Singh P, Dobhal R. Water Quality Assessment in Terms of Water Quality Index. *Am. J. Water Resour*, 2013; 1(3): 34–38.
12. Mahesha, Balasubramanian A. Analysis of Water Quality Index (WQI) in Dalvoy Lake, Mysore City, India. *Nat. Environ. Pollut. Technol*, 2010; 9(4): 663–670.
13. Upadhyay A, Chandrakala M. Water quality assessment of Dalvoy Lake water, Mysore, Karnataka, India. *Int. J. Sci. Environ. Technol*, 2016; 5(5): 3254–3261.
14. Mamatha M. Water Quality Assessment of Kukkarahalli Lake Water Mysore, Karnataka, India. *Int. Res. J. Eng. Technol*, 2017; 4(3): 2303–2307.
15. Deepthi S, Yamakanamardi SM. Abundance of Cladoceran zooplankton in Varuna, Madapa and Giribettethelakes of Mysore, Karnataka state, India. *Int. J. Sci. Environ. Technol*, 2014; 3(3):885–900.
16. Eaton AD, Standard methods for the examination of water and wastewater, Washington, D.C; 2005.
17. Trivedy RK, Goel PK, "Chemical and biological methods for water pollution studies.," *Environ. Publ. India*; 1986.
18. BIS, Specifications for Drinking Water-Indian Standard: IS 10500. New Delhi, India; 2012.
19. ICMR, Manual of standards of quality for drinking water supplies. New Delhi, India; 1975.
20. Brown RM, McClelland NJ, Deininger RA, O'Connor MF. A Water Quality Index—Crossing the Psychological Barrier. *Proceedings of the International Conference on Water Pollution Research*. Jerusalem, 1972; 787–797.
21. Chatterjee C, Raziuddin M. Determination of water quality index (WQI) of a degraded river in Asanol Industrial area, Raniganj, Burdwan, West Bengal. *Nat. Environ. Pollut. Technol*. 2002;1.
22. Dallas H, Day J. The Effect of Water Quality Variables on Aquatic Ecosystems: A Review. *Water Res. Comm. Pretoria South Afr*, 2004.
23. Latha NS, Rai NA. Ecological studies of Banjara lake with reference to water pollution. *J. Environ. Biol.*, 1998; 19: 179–186.
24. Gupta N, Pandey P, Hussain J. Effect of physicochemical and biological parameters on the quality of river water of Narmada, Madhya Pradesh, India. *Water Sci*, 2017; 31(1): 11–23.
25. Pal M, Samal N, Roy P, Biswas Roy M. Electrical Conductivity of Lake Water as Environmental Monitoring –A Case study of Rudra sagar Lake. *J. Environ. Sci. Food Technol*, 2015.
26. Sharma S, Chhipa RC. Seasonal variations of ground water quality and its agglomerates by water quality index. *Glob. J. Environ. Sci. Manag*, 2016; 2(1): 79–86.
27. Hussain BA, Chandra BR, Amalash D. A Study of the Limnology and Ichthyology of Dhir Beel at Dhubri, Assam, India. *Int. Res. J. Biol. Sci*, 2015; 4(8): 40–48.
28. Kalaiarasi M, Paul P, Lathasumathi C, Stella C. Seasonal variations in the physico-chemical characteristics of the two coastal waters of Palk-strait in Tamil Nadu, India. *Glob. J. Environ. Res*, 2012; 6(2):66–74.





### Abhilash and Mahadevaswamy

29. Thakor FJ, Bhoi DK, Dabhi HR, Pandya SN, Nikitaraj BC. Water Quality Index (W.Q.I.) of Pariyej Lake Dist. Kheda - Gujarat. *Curr. World Environ*, 2011;6: 225–231.
30. Saluja DS. Physico-Chemical Analysis of Potable Water Quality of Machna River at District Betul (M.P.). *Int. J. Sci. Res*, 2018; 9(4):1294-1296.
31. Singh A, Jayakumar S. Water Quality Assessment of Kanwar Lake, Begusarai, Bihar, India. *Imp. J. Interdiscip. Res*, 2016;2(4):793-803.
32. Oliveira-Filho EC, Caixeta NR, Simplício NCS, Sousa SR, Aragão TP, Muniz DHF. Implications of water hardness in ecotoxicological assessments for water quality regulatory purposes: a case study with the aquatic snail *Biomphalaria glabrata* (Say, 1818). *Braz. J. Biol*, 2014;74:175–180.
33. Wurts W. Understanding Water Hardness. *World Aquac*, 1993; 24:18.
34. Kannan K, Fundamentals of Environmental Pollution. New Delhi:S. Chand and Company Ltd., 1991.
35. Wetzel RG, *Limnology*, 2nd ed. Philadelphia. U.S.A: Saunders College Publishing, 1983.
36. Qureshimatva MR, Maurya RR, Gamit SB, Patel RD, Solanki HA. Determination of Physico-Chemical Parameters and Water Quality Index (Wqi) of Chandlodia Lake, Ahmedabad, Gujarat, India. *J. Environ. Anal. Toxicol*, 2015; 5(4):288.
37. Dhinamala K, Pushpalatha M, Samuel T, Raveen R. Spatial and temporal variations in the water quality parameters of Pulicat Lake, Tamil Nadu, India. *Int. J. Fish. Aquat. Stud*, 2015; 3(2): 255-259.
38. Koushik S, Saksena DN, Physico-chemical limnology of certain fresh water bodies of Central India, in fresh water eco-system of India. New Delhi, India: Daya Publ. House, 1999. p.1-58.
39. Kaur S, Kaur J. Assessment of Seasonal variations in oxygen demanding parameters (DO, BOD, COD) along Sirhind Canal passing through Moga, Punjab, India. *Int. J. Innov. Sci. Eng. Technol*, 2015; 2(5): 697-700
40. Unadkat K, Parikh P. Water Quality Index of Harni Pond, District Vadodara, Gujarat. *Res. Rev*, 2018; 1:6–15.
41. Solanki AH, "Status of soils and water reservoirs near industrial areas of Baroda: pollution and soil - water chemistry," Lap Lambert Acad. Publ. Germany; 2012.
42. Lazizi A, Laifa A. Assessment of the Surface Water Quality: A Case of Wadi El-Kébir West Watershed, Skikda, North-East Algeria. *Nat. Environ. Pollut. Technol*, 2020; 19(5): 1977–1985.
43. Khatri N, Tyagi S. Influences of natural and anthropogenic factors on surface and groundwater quality in rural and urban areas. *Front. Life Sci*, 2015; 8(1): 23–39.
44. Smith SH. Temperature Correction in Conductivity Measurements1. *Limnol. Oceanogr*, 1962; 7(3):330–334.
45. Hayashi M. Temperature-Electrical Conductivity Relation of Water for Environmental Monitoring and Geophysical Data Inversion. *Environ. Monit. Assess*, 2004; 96 (3):119–128.
46. Potaszniak A, Szymczyk S. Magnesium and calcium concentrations in the surface water and bottom deposits of a river-lake system. *J. Elem*, 2015; 20(3):677–692.
47. Dadgar P, Payandeh PE. Investigation of Nitrate Concentration and Its Correlation with Water pH in Drinking Water Distribution Network of the City of Tabriz. *Int. J. Sci. Std*, 2017;5(4):726-731.
48. Yogendra K, Puttaiah ET. Determination of water quality index and suitability of an urban waterbody in Shimoga Town, Karnataka. *Proceedings of Taal2007: The 12th World Lake Conference*, 2008; 342–346.
49. Kulkarni VS, Tapase BS. Physico-chemical parameters and water quality index of Gandhisagar Lake of Umrer in Nagpur District. *J. Biosci*, 2011; 2(3):366–369.

**Table 1: Relative weight (W<sub>n</sub>) of parameters used for WQI calculation.**

Parameters	Standard (Sn)	Recommended agency	W <sub>n</sub> =K/Sn
pH	8.5	ICMR/BIS	0.15163
Cond.(μS)	300	BIS	0.00430
TDS	500	ICMR/BIS	0.00258
DO	5	ICMR/BIS	0.25778
Calcium	75	ICMR/BIS	0.01719
Hardness	300	ICMR/BIS	0.00430





**Abhilash and Mahadevaswamy**

TA	200	BIS	0.00644
BOD	5	ICMR	0.25778
Nitrate	45	BIS	0.02864
Sulphate	200	BIS	0.00644
Chloride	250	ICMR/BIS	0.00516
Turbidity	5	BIS	0.25778
		$\sum W_n =$	1.00000

BIS: Bureau of Indian Standard and ICMR: Indian Council of Medical Research

**Table 2: Water quality index grading [20, 21]**

WQI	Water quality status	Possible usage
0-25	Excellent	Drinking, irrigation and industrial
26-50	Good	Drinking, irrigation and industrial
51-75	Poor	Irrigation and industrial
76-100	Very poor	Irrigation
Above 100	Unsuitable for drinking and fish culture	Proper treatment required before use

**Table 3: Seasonal fluctuation in physicochemical parameters at Varuna Lake from October 2017 to September 2018**

Parameters	Post-monsoon (Mean ± SD)	Pre-monsoon (Mean ± SD)	Monsoon (Mean ± SD)	F-Value <sup>1</sup>	p-value
Water temp. (°C)	26.92 ± 0.07	30.73 ± 0.16	28.76 ± 0.88	7.9676	0.0102*
pH	8.18 ± 0.04	8.98 ± 0.26	8.24 ± 0.25	3.9227	0.0596
E.C. (µS cm <sup>-1</sup> )	250.67 ± 7.00	273.67 ± 8.42	260.17 ± 31.57	1.1954	0.3464
T.D.S (mg L <sup>-1</sup> )	139.5 ± 4.92	142.67 ± 4.04	132 ± 15.74	2.1301	0.1748
Turbidity (NTU)	3.83 ± 0.73	8.12 ± 1.63	3.51 ± 0.56	1.9486	0.1981
DO (mg L <sup>-1</sup> )	5.27 ± 0.14	5.28 ± 0.1	5.4 ± 0.22	0.0921	0.9129
FCO <sub>2</sub> (mg L <sup>-1</sup> )	3.98 ± 2.17	0	3.85 ± 2.91	1.8593	0.2109
Calcium (mg L <sup>-1</sup> )	22.20 ± 0.86	16.49 ± 0.59	17.63 ± 2.10	2.4069	0.1454
Hardness (mg L <sup>-1</sup> )	101.83 ± 2.08	91.50 ± 3.12	93.17 ± 13.14	1.6741	0.2409
TA (mg L <sup>-1</sup> )	101.92 ± 3.74	107.50 ± 1.09	93.17 ± 8.89	2.0348	0.1866
COD (mg L <sup>-1</sup> )	20.34 ± 1.14	42.93 ± 2.66	21.47 ± 2.82	8.8825	0.0074*
BOD (mg L <sup>-1</sup> )	1.57 ± 0.13	3.81 ± 0.27	1.85 ± 0.24	7.2554	0.0133*
Nitrate (mg L <sup>-1</sup> )	1.40 ± 0.26	0.59 ± 0.14	1.68 ± 0.19	0.8587	0.4557
Phosphate (mg L <sup>-1</sup> )	< 0.1	< 0.1	< 0.1	-	-
Sulphate (mg L <sup>-1</sup> )	9.1 ± 0.76	10.92 ± 0.75	4.9 ± 0.32	1.6602	0.2434
Chloride (mg L <sup>-1</sup> )	21.47 ± 2.17	30.40 ± 0.54	26.37 ± 0.46	2.5784	0.1302

<sup>1</sup>value obtained from one way - ANOVA test; \* = Significant (p<0.05).

Note: E.C – Electrical conductivity; T.D.S – Total Dissolved Solids; DO – Dissolved Oxygen; FCO<sub>2</sub> – Free Carbon-di-Oxide; TA – Total Alkalinity; COD – Chemical Oxygen Demand; BOD – Biological Oxygen Demand;





**Abhilash and Mahadevaswamy**

**Table 4: Correlation coefficient between water quality parameters in Varuna Lake**

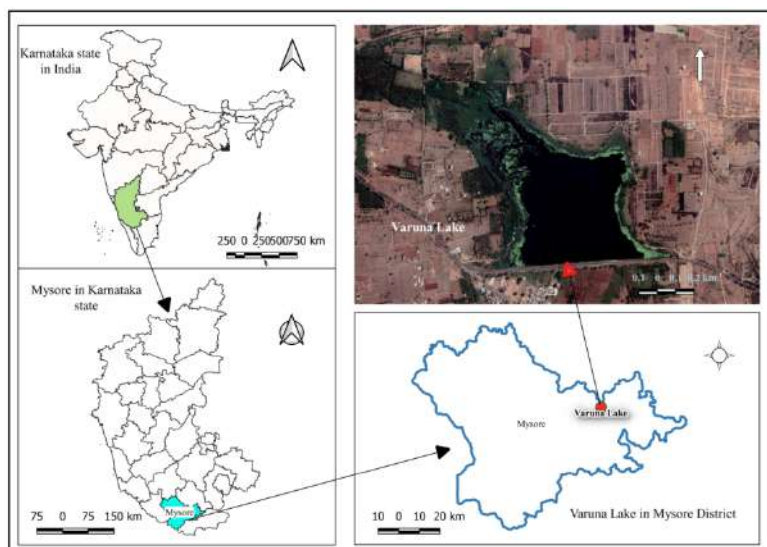
	WT	pH	EC	TDS	DO	Ca	Hard.	TA	COD	BOD	NO <sub>3</sub>	SO <sub>2-4</sub>	Cl-	Tur.
WT	1.00													
pH	0.28	1.00												
EC	.790**	-0.14	1.00											
TDS	0.37	-0.04	.718**	1.00										
DO	-0.05	0.28	-0.17	-0.37	1.00									
Ca	-0.33	-.661*	0.22	0.50	-0.25	1.00								
Hard.	-0.10	-0.51	0.41	.614*	0.03	.761**	1.00							
TA	0.35	-0.05	0.43	.660*	-0.24	0.27	0.37	1.00						
COD	0.56	0.53	0.27	0.15	0.03	-0.47	-0.41	0.25	1.00					
BOD	0.51	0.50	0.21	0.02	0.10	-0.48	-0.47	0.25	.961**	1.00				
NO <sub>3</sub>	-0.15	-.753**	0.22	0.14	0.00	0.41	.680*	0.18	-0.52	-0.50	1.00			
SO <sub>2-4</sub>	0.11	-0.02	0.16	0.46	-0.24	0.42	0.18	0.50	0.29	0.18	-0.29	1.00		
Cl-	0.25	0.17	0.14	0.03	-0.13	-0.16	-0.35	0.30	0.41	0.56	-0.28	0.08	1.00	
Tur.	0.20	0.48	0.05	0.21	-0.16	-0.55	-0.24	0.13	0.24	0.15	-0.08	-0.36	-0.01	1.00

\*\* Correlation is significant at the 0.01 level (2-tailed). \*Correlation is significant at the 0.05 level (2-tailed).

Note: WT – Water temperature; E.C – Electrical conductivity; T.D.S – Total Dissolved Solids; DO – Dissolved Oxygen; Ca - calcium; Hard. – Hardness; TA – Total Alkalinity; COD – Chemical Oxygen Demand; BOD – Biological Oxygen Demand; NO<sub>3</sub>– Nitrate; SO<sub>2-4</sub>– Sulphate; Cl- Chloride; Tur. - Turbidity

**Table 5: Summary of water quality index of Varuna Lake.**

Seasons	WQI	WQS
Post-monsoon	66.35	Poor
Pre-monsoon	107.92	Unsuitable
Monsoon	66.55	Poor
Overall WQI	80.27	Very Poor



**Fig. 1: Map of Mysore district showing the location of Varuna Lake**





## Regular Semiopen Sets in Neutrosophic Topological Spaces

R.Vijayalakshmi<sup>1\*</sup> and R. R. Praveena<sup>2</sup>

<sup>1</sup>Department of Mathematics, Arignar Anna Government Arts College, Nammakkal, Tamil Nadu-637 002, India.

<sup>2</sup>Research Scholar, Department of Mathematics, Annamalai University, Annamalai Nagar, Tamil Nadu – 608 002, India.

Received: 15 Dec 2021

Revised: 02 Jan 2022

Accepted: 18 Jan 2022

### \*Address for Correspondence

**R.Vijayalakshmi**

Department of Mathematics,  
Arignar Anna Government Arts College,  
Nammakkal, Tamil Nadu-637 002, India.  
Email: viji\_lakshmi80@rediffmail.com



This is an Open Access Journal / article distributed under the terms of the **Creative Commons Attribution License** (CC BY-NC-ND 3.0) which permits unrestricted use, distribution, and reproduction in any medium, provided the original work is properly cited. All rights reserved.

### ABSTRACT

In this paper, we introduce and study the concept of neutrosophic regular semiopen (semiclosed) sets in neutrosophic topological spaces. By using neutrosophic regular semiopen (semiclosed) sets, we define a new neutrosophic closure operator namely neutrosophic regular semi interior (closure) operator and neutrosophic regular semi neighborhood. Also the relation between these sets and counter examples for the reverse relation are given.

**Keywords:** Neutrosophic regular semiopen, Neutrosophic regular semiclosed sets, neutrosophic regular semi interior, neutrosophic regular semi closure operator and neutrosophic regular semi neighborhood.

### INTRODUCTION

Smarandache [3, 4, 5] introduced the notion of Neutrosophic set, it is classified into three independent functions namely, membership, indeterminacy and non membership function that are independently related. In 2012, Salama and Alblowi [7, 8, 9] introduced the concept of Neutrosophic topology, neutrosophic closed sets and neutrosophic continuous functions. Ishwarya and Bageerathi [6] introduced the notion of neutrosophic semi-open sets in neutrosophic topological spaces. In general topology, the notion of regular semiopen set was introduced by Cameron [1] in 1978. In this concept has been generalized to neutrosophic setting. This paper introduce and study the concept of neutrosophic regular semiopen (semiclosed) sets in neutrosophic topological spaces. By using neutrosophic regular semiopen (semiclosed) sets, we define a new neutrosophic closure operator namely neutrosophic regular semi closure (interior) operator and investigate their properties which are important for further research on neutrosophic topology.

### Preliminaries

We recall some basic definitions that are used in the sequel.





**Vijayalakshmi and Praveena**

**Definition 2.1.** [7] Let  $X$  be a non-empty fixed set. A Neutrosophic set [for short,  $Ns$ ]  $R$  is an object having the form  $R = \{(x, \mu_R(x), \sigma_R(x), \gamma_R(x)) : x \in X\}$  where  $\mu_R(x)$ ,  $\sigma_R(x)$  and  $\gamma_R(x)$  which represents the degree of membership, indeterminacy and non-membership function of each element  $x \in X$  to the set  $R$ .

**Remark 2.1.** [7] A  $Ns$   $R = \{(x, \mu_R(x), \sigma_R(x), \gamma_R(x)) : x \in X\}$  can be identified to an ordered triple  $R = \langle x, \mu_R(x), \sigma_R(x), \gamma_R(x) \rangle$  in  $]0, 1^+[$  on  $X$ .

**Definition 2.2.** [7] A  $Ns$ 's  $R$  and  $S$  of the form  $R = \{(x, \mu_R(x), \sigma_R(x), \gamma_R(x)) : x \in X\}$  and  $S = \{(x, \mu_S(x), \sigma_S(x), \gamma_S(x)) : x \in X\}$  of  $X$ . Then

$$0_N = \{(x, 0, 0, 1) : x \in X\} \text{ and } 1_N = \{(x, 1, 1, 0) : x \in X\}$$

$$R^c = \{(x, \mu_R(x), 1 - \sigma_R(x), \gamma_R(x)) : x \in X\}$$

$$R \subseteq S \Leftrightarrow \{ \mu_R(x) \leq \mu_S(x), \sigma_R(x) \leq \sigma_S(x), \gamma_R(x) \geq \gamma_S(x) \forall x \in X \}$$

$$R \cup S = \langle x, \mu_R(x) \vee \mu_S(x), \sigma_R(x) \vee \sigma_S(x), \gamma_R(x) \wedge \gamma_S(x) \rangle$$

$$R \cap S = \langle x, \mu_R(x) \wedge \mu_S(x), \sigma_R(x) \wedge \sigma_S(x), \gamma_R(x) \vee \gamma_S(x) \rangle$$

**Definition 2.3.** [7] A Neutrosophic topology (for short,  $NT$  or  $nt$ ) is a non-empty set  $X$  is a family  $\tau_N$  of neutrosophic subsets in  $X$  satisfying

$$0_N, 1_N \in \tau_N,$$

$$G_1 \cap G_2 \in \tau_N \text{ for any } G_1, G_2 \in \tau_N,$$

$$\cup G_j \in \tau_N \text{ for every } \{G_j : j \in J\} \subseteq \tau_N.$$

Throughout this paper, the pair of  $(X, \tau_N)$  is called a neutrosophic topological space (for short,  $nts$ ). The elements of  $\tau_N$  or  $\tau$  are called neutrosophic open set (for short,  $nos$ ). A  $Ns$   $F$  is  $nos$  if and only if  $F^c$  is  $ncs$ .

**Definition 2.4.** [7] Let  $(X, \tau)$  be  $nts$ ,  $R = \langle x, \mu_R(x), \sigma_R(x), \gamma_R(x) \rangle$  be a  $Ns$  in  $X$ . Then the neutrosophic closure and neutrosophic interior of  $R$  are defined by  $NCl(R) = \cap \{K : R \subseteq K \text{ and } K \text{ is a } ncs \text{ in } X\}$  and  $NInt(R) = \{G : G \subseteq R \text{ and } G \text{ is a } nos \text{ in } X\}$ .

**Definition 2.5.** [10] A  $nts$   $(X, \tau)$ , and a  $Ns$   $R = \langle x, \mu_R(x), \sigma_R(x), \gamma_R(x) \rangle$  of  $X$ . Then  $R$  is called:

neutrosophic regular open (for short,  $nro$ ) iff  $R = NInt(NCl(R))$ .

neutrosophic semi-open (for short,  $nso$ ) iff  $R \subseteq NInt(NCl(R))$ .

The complement of  $nro$ ,  $nso$  sets are called  $nrc$ ,  $nsc$  sets.

**Definition 2.6.** [2] Let  $X$  be a nonempty set. If  $r, t, s$  be real standard or non standard subsets of  $]0, 1^+[$ , then the  $Ns$   $x_{r,t,s}$  is called neutrosophic point (briefly  $np$ ) of  $X$  given by  $x_{r,t,s}(x_p) = r, t, s$  if  $x = x_p$  and  $x_{r,t,s}(x_p) = (0, 0, 1)$  if  $x \neq x_p$  for  $x_p \in X$  is called the support of  $x_{r,t,s}$ , where  $r$  denotes the degree of membership value,  $t$  the degree of indeterminacy and  $s$  the degree of non-membership value of  $x_{r,t,s}$ .

**Neutrosophic Regular Semiopen and Neutrosophic Regular Semiclosed Sets**

**Definition 3.1.** A  $nts$   $(X, \tau)$ , then  $R$  is called:

(i) neutrosophic regular semiopen set (for short,  $nrsos$ ) if  $\exists$  an  $nro$  set  $S \ni S \subseteq R \subseteq NCl(S)$ .

(ii) neutrosophic regular semiclosed (for short,  $nrscs$ ) set if  $\exists$  an  $nrc$  set  $S \ni NInt(S) \subseteq R \subseteq S$ .

We shall denote the family of all  $nrsos$  ( $nrscs$ ) of a  $nts$   $(X, \tau)$  by  $NRSOS(X)$ ,  $NRSCS(X)$ .

**Example 3.1** Let  $X = \{a, b\}$ ,  $R, S$ , and  $T$  are  $Ns$ 's of  $X$  defined as follows:

$$R = \langle (\mu_a/0.4, \mu_b/0.5), (\sigma_a/0.5, \sigma_b/0.5), (\gamma_a/0.6, \gamma_b/0.5) \rangle$$

$$S = \langle (\mu_a/0.4, \mu_b/0.5), (\sigma_a/0.5, \sigma_b/0.5), (\gamma_a/0.4, \gamma_b/0.5) \rangle$$

$$T = \langle (\mu_a/0.5, \mu_b/0.5), (\sigma_a/0.5, \sigma_b/0.5), (\gamma_a/0.6, \gamma_b/0.5) \rangle$$







Vijayalakshmi and Praveena

Clearly  $\tau = \{0_N, 1_N, R, S\}$  is a nt on X. The Ns T is nrso set of  $(X, \tau)$ , since  $\exists$  a nro set  $S \ni S \subseteq T \subseteq NCI(S)$ .

**Example 3.2** In Example 3.1, the Ns T is nrso set but not nro set.

**Example 3.3** Let  $X = \{a, b\}$ , R, S, and T are Ns 's of X defined as follows:

$$R = ((\mu_a/0.3, \mu_b/0.5), (\sigma_a/0.5, \sigma_b/0.5), (\gamma_a/0.6, \gamma_b/0.5))$$

$$S = ((\mu_a/0.6, \mu_b/0.5), (\sigma_a/0.5, \sigma_b/0.5), (\gamma_a/0.5, \gamma_b/0.5))$$

$$T = ((\mu_a/0.4, \mu_b/0.5), (\sigma_a/0.5, \sigma_b/0.5), (\gamma_a/0.6, \gamma_b/0.5))$$

Clearly  $\tau = \{0_N, 1_N, R, S\}$  is a nt on X. The Ns T is nso set of  $(X, \tau)$ , but T is not nrso set.

**Remark 3.1.** From definition of nrso (nrsc) sets and Examples 3.1, 3.2 and 3.3 it is clear that every nrso (nrsc) is a nrso (nrsc) but not conversely.  
every nrso is a nso set but not conversely.

**Remark 3.2.**  $0_N$  and  $1_N$  are always nrsc and nrso sets.

**Theorem 3.1.** Arbitrary union of nrso sets is a nrso set.

**Proof.** Let  $\{R_i \mid i \in I\}$  be a family of nrso  $(X, \tau)$ . Then  $\exists$  a nro sets  $B_i$  such that  $S_i \subseteq R_i \subseteq NCI(S_i)$  for each i. Thus  $\cup S_i \subseteq \cup R_i \subseteq \cup NCI(S_i)$  and  $S_i$  is nrso. So  $R_i$  is a nrso set.

**Remark 3.3.** Arbitrary intersection of nrsc sets is a nrsc set.

**Theorem 3.2.** If a nrso R is such that  $R \subseteq T \subseteq NCI(R)$ , then T is also nrso.

**Proof.** As R is nrso set,  $\exists$  an nro set  $S \ni S \subseteq R \subseteq NCI(S)$ . Then, by hypothesis,  $S \subseteq T$  and  $NCI(R) \subseteq NCI(S)$ . So  $T \subseteq NCI(R) \subseteq NCI(S)$  i.e.,  $S \subseteq T \subseteq NCI(S)$ . Hence T is nrso set.

**Theorem 3.3.** If a nrsc R is such that  $NInt(R) \subseteq S \subseteq R$ , then S is also nrsc set.

**Definition 3.2.** Let  $(X, \tau)$  be a nts. Then

- (i) the neutrosophic regular semiclosure of R defined by  $nrsc(R) = \{S \mid R \subseteq S \text{ and } S \in NRSCS(X, \tau)\}$  is a ns.
  - (ii) the neutrosophic regular semiinterior of R defined by  $nr sint(R) = \{S \mid S \subseteq R \text{ and } S \in NRSOS(X, \tau)\}$  is a ns.
- Clearly,  $nrsc(R)$  is the smallest nrsc containing R and  $nr sint(R)$  is the largest nrso contained in R.

**Theorem 3.4.** Let  $(X, \tau)$  be a nts, R, S are Ns's of X. Then

- (i)  $R \in NRSCS(X) \Leftrightarrow R = nrsc(R)$ ,
- (ii)  $R \in NRSOS(X) \Leftrightarrow R = nr sint(R)$ ,
- (iii)  $(nrsc(R))^c = nr sint(R^c)$ ,
- (iv)  $(nr sint(R))^c = nrsc(R^c)$ ,
- (v)  $R \subseteq S \Rightarrow nr sint(R) \subseteq nr sint(S)$ ,
- (vi)  $R \subseteq S \Rightarrow nrsc(R) \subseteq nrsc(S)$ ,
- (vii)  $nrsc(0_N) = 0_N$  and  $nrsc(1_N) = 1_N$ ,
- (viii)  $nr sint(0_N) = 0_N$  and  $nr sint(1_N) = 1_N$ ,
- (ix)  $nrsc(R \cup S) = nrsc(R) \cup nrsc(S)$ ,
- (x)  $nr sint(R \cap S) = nr sint(R) \cap nr sint(S)$ ,
- (xi)  $nrsc(R \cap S) \subseteq nrsc(R) \cap nrsc(S)$ ,
- (xii)  $nr sint(R \cup S) \subseteq nr sint(R) \cup nr sint(S)$ ,
- (xiii)  $nrsc(nrsc(R)) = nrsc(R)$ ,
- (xiv)  $nr sint(nr sint(R)) = nr sint(R)$ .

**Proof.** Let R and S be two Ns's of X.

- (i) Let R be a nrsc set. Then it is the smallest nrsc set containing itself Thus  $R = nrsc(R)$ . On the other hand, let  $R = nrsc(R)$  and  $nrsc(R) \in NRSCS(X)$ . Then  $R \in NRSCS(X)$ .





Vijayalakshmi and Praveena

- (ii) Similar to (1).
- (iii)  $(nr scl(R))^C = (\cap\{S | R \subseteq S \ \& \ S \in NRSCS(X)\})^C = U\{S^C | R \subseteq S \ \& \ S \in NRSCS(X)\} = U\{S^C | S^C \subseteq R^C \ \& \ S^C \in NRSOS(X)\} = nr sint(R^C)$ .
- (iv) Similar to (iii).
- (v) Follows from definitions.
- (vi) Follows from definitions.
- (vii) Since  $0_N$  and  $1_N$  are nrsc sets so  $nr scl(0_N) = 0_N$  and  $nr scl(1_N) = 1_N$ .
- (viii) Since  $0_N$  and  $1_N$  are nrso sets so  $nr sint(0_N) = 0_N$  and  $nr sint(1_N) = 1_N$ .
- (ix) We have  $R \subseteq RUS$  and  $S \subseteq RUS$ . Then by (vi),  $nr scl(R) \subseteq nr scl(RUS)$  and  $nr scl(S) \subseteq nr scl(RUS)$ . Thus  $nr scl(S) \cup nr scl(R) \subseteq nr scl(RUS)$ . Since,  $nr scl(R), nr scl(S) \in NRSCS(X)$ ,  $nr scl(S) \cup nr scl(R) \in NRSCS(X)$ . Then  $R \subseteq nr scl(R)$  and  $S \subseteq nr scl(S)$  imply that  $RUS \subseteq nr scl(R) \cup nr scl(S)$ . Thus,  $nr scl(R) \cup nr scl(S)$  is nrsc set containing  $RUS$ . But  $nr scl(RUS)$  is the smallest nrsc set containing  $RUS$ . So  $nr scl(RUS) \subseteq nr scl(R) \cup nr scl(S)$ . Hence  $nr scl(RUS) = nr scl(R) \cup nr scl(S)$ .
- (x) Similar to (ix).
- (xi) We have  $R \cap S \subseteq R$  and  $R \cap S \subseteq S$ . Then  $nr scl(R \cap S) \subseteq nr scl(R)$  and  $nr scl(R \cap S) \subseteq nr scl(S)$ . Thus  $nr scl(R \cap S) \subseteq nr scl(R) \cap nr scl(S)$ .
- (xii) Similar to (xi).
- (xiii) Since  $nr scl(R) \in NRSCS(X)$  so by (i),  $nr scl(nr scl(R)) = nr scl(R)$ .
- (xiv) Since  $nr sint(R) \in NRSOS(X)$  so by (ii),  $nr sint(nr sint(R)) = nr sint(R)$ .

**Definition 3.3.** A nts  $(X, \tau)$ , and a Ns  $R$  is said to be neutrosophic semi-regular if it is both nso set and nsc set. Equivalently, a Ns  $R$  is said to be neutrosophic semi regular open if  $R = nr sint(nr scl(R))$ . The family of all neutrosophic semi-regular set of  $(X, \tau)$  is denoted by  $NSRS(X)$ .

**Theorem 3.5.** If  $R$  is any Ns in a nts  $(X, \tau)$  then following are equivalent:

- (i)  $R \in NSRS(X)$ ,
- (ii)  $R = nr sint(nr scl(R))$ ,
- (iii)  $\exists$  a nro set  $S \ni S \subseteq R \subseteq NCI(S)$ .

**Proof.** (i)  $\Rightarrow$  (ii) If  $R \in NSRS(X)$ , then  $nr sint(nr scl(R)) = nr sint(R) = R$ .

(ii)  $\Rightarrow$  (iii) Suppose  $R = nr sint(nr scl(R))$ . Since  $NInt(NCI(R)) \subseteq nr scl(R)$  for any Ns  $R$  of  $X$ ,  $NInt(NCI(R)) \subseteq nr sint(nr scl(R)) = R$ . Since  $R \in NSOS(X)$  we have  $R \subseteq NCI(nr sint(R))$ . Then, we obtain  $NInt(NCI(R)) \subseteq R \subseteq NCI(NInt(R)) \subseteq NCI(NInt(NCI(R)))$ . Since  $NInt(NCI(NInt(NCI(R)))) = NInt(NCI(R))$ ,  $NInt(NCI(R))$  is nro set.

(iii)  $\Rightarrow$  (i) It is obvious that  $R \in NSOS(X)$ . We have  $NInt(NCI(R)) = NInt(NCI(S)) = S \subseteq R$ . Then  $R$  is nsc set. Thus, we obtain  $R \in NSRS(X)$ .

**Proposition 3.1.** If  $R \in NSOS(X)$ , then  $nr scl(R) \in NSRS(X)$ .

**Proof.** Since  $nr scl(R)$  is nsc set, we show that  $nr scl(R) \in NSOS(X)$ . Since  $R \in NSOS(X)$ ,  $S \subseteq R \subseteq NCI(S)$  for nos  $S$  of  $X$ . Then, we have  $S \subseteq nr scl(S) \subseteq nr scl(R) \subseteq NCI(S)$ . Thus  $nr scl(R) \in NSRS(X)$ .

**Proposition 3.2.** If  $R$  is nrso set in  $(X, \tau)$ , then  $R^C$  is also nrso set.

**Proof.** Follows from the Definition 3.1.

**Proposition 3.3.** In a nts  $(X, \tau)$ , the nrc, nro and nrclopen sets are nrso sets.

**Definition 3.4.** A Ns  $R$  in a nts  $(X, \tau)$  is called neutrosophic regular semi neighborhood (briefly, nrnsbd) of the neutrosophic point  $x_{r,t,s} \in X$  if  $\exists$  a nrso set  $S$  such that  $x_{r,t,s} \in S \subseteq R$ . The neutrosophic regular semi neighborhood system of a neutrosophic point  $x_{r,t,s}$ , denoted by  $NRSN(x_{r,t,s})$ , is the family of all its neutrosophic regular semi neighborhoods.

**Definition 3.5.** A Ns  $R$  in a nts  $(X, \tau)$  is called a neutrosophic regular semi neighborhood (briefly, nrnsbd) of the neutrosophic set  $S$  if  $\exists$  a nrso set  $T \ni S \subseteq T \subseteq R$ .





### Vijayalakshmi and Praveena

**Theorem 3.6.** The neutrosophic regular semi neighborhood system  $NRSN(x_{r,t,s})$  at  $x_{r,t,s}$  of a nts  $(X, \tau)$  has the following:

(i) If  $R \in NRSN(x_{r,t,s})$ , then  $x_{r,t,s} \in R$ .

(ii)  $R \in NRSN(x_{r,t,s})$  and  $R \subseteq S$ , then  $S \in NRSN(x_{r,t,s})$ .

(iii)  $R, S \in NRSN(x_{r,t,s})$ , then  $R \cap S \in NRSN(x_{r,t,s})$ .

(iv)  $R \in NRSN(x_{r,t,s})$ , then  $\exists$  a  $S \in NRSN(x_{r,t,s})$  such that  $R \in NRSN(y_{r,t,s})$  for each  $y_{r,t,s} \in S$ .

**Proof.** (i) If  $R \in NRSN(x_{r,t,s})$ , then  $\exists$  a  $S \in NRSOS(X)$  such that  $x_{r,t,s} \in S \subseteq R$ . Then, we have  $x_{r,t,s} \in R$ .

(ii) Let  $R \in NRSN(x_{r,t,s})$  and  $R \subseteq S$ . Since  $R \in NRSN(x_{r,t,s})$ , then  $\exists$  a  $T \in NRSOS(X)$  such that  $x_{r,t,s} \in T \subseteq R$ . Then, we have  $x_{r,t,s} \in T \subseteq R \subseteq S$ . Thus  $S \in NRSN(x_{r,t,s})$ .

(iii) If  $R, S \in NRSN(x_{r,t,s})$ , then  $\exists$   $T, U \in NRSOS(X)$  such that  $x_{r,t,s} \in T \subseteq R$  and  $x_{r,t,s} \in U \subseteq S$ . Thus  $x_{r,t,s} \in T \cap U \subseteq R \cap S$ . Since  $T \cap U \in \tau$ , we have  $R \cap S \in NRSN(x_{r,t,s})$ .

(iv) If  $R \in NRSN(x_{r,t,s})$ , then  $\exists$  a  $U \in NRSOS(X)$  such that  $x_{r,t,s} \in U \subseteq R$ . Put  $T=U$ . Then for every  $y_{r,t,s} \in T$ ,  $y_{r,t,s} \in T \subseteq U \subseteq R$ . This implies  $R \in NRSN(y_{r,t,s})$ .

## CONCLUSION

In this paper, we have studied the concept of nrso and nrsc sets in nts's. By using nrso (nrsc) sets, we define a new neutrosophic interior, closure operators namely neutrosophic regular semi interior, neutrosophic regular semi closure operator. Also the relation between these sets and counter examples for the reverse relation are given. In future, we can be extended to neutrosophic regular semi continuous, neutrosophic regular semi irresolute and neutrosophic regular semi contra continuous in nts.

## REFERENCES

1. Cameron, D. E. (1978). Properties of S-closed spaces, Proc. Amer. Math. Soc., 72, 581–586.
2. Dhavaseelan D and Jafari, S. Generalized neutrosophic contra-continuity submitted.
3. Smarandache F, A Unifying Field in Logic: Neutrosophic Logic. Neutrosophy, Neutrosophic set, Neutrosophic Probability, Ameican Research Press, Rehoboth, NM, 1999.
4. Smarandache F, Neutrosophy and Neutrosophic Logic, First International Conference on Neutrosophy, Neutrosophic Logic, Set, Probability, and Statistics, University of New Mexico, Gallup, NM 87301, USA, 2002.
5. Smarandache F, (2010). Neutrosophic Set: A Generalization of Intuitionistic Fuzzy set, Journal of Defense Resources Management, 1, 107–116.
6. Ishwarya P and Bageerathi K. (2016). On Neutrosophic semi-open sets in Neutrosophic topological spaces, International Jour. of Math. Trends and Tech. 214-223.
7. Salama A. A, and Alblowi, S. A. (2012). Neutrosophic set and Neutrosophic topological space, ISOR J. Mathematics, 3(4), 31–35.
8. Salama A. A, and Alblowi, S. A. (2012). Generalized Neutrosophic Set and Generalized Neutrosophic Topological Spaces, Journal computer Sci. Engineering, 2(7), (2012), 12–23.
9. Salama, A. A. Florentin Smarandache and Valeri Kroumov, (2014). Neutrosophic Closed set and Neutrosophic Continuous Function, Neutrosophic Sets and Systems, 4, 4–8.
10. Wadel Faris Al-omeri and Florentin Smarandache, (2016). New Neutrosophic Sets via Neutrosophic Topological Spaces, New Trends in Neutrosophic Theory and Applications, 2 June 2016.





## Trivariate Stochastic Modeling for Tumor Cell Growth using First Order Moments in the Presence of Oncolytic Virotherapy

S.Vijaya<sup>1</sup> and S.Savitha<sup>2\*</sup>

<sup>1</sup>Department of Mathematics, Annamalai University, Chidambaram – 608002, Tamil Nadu, India.

<sup>2</sup>PG and Research Department of Mathematics, Sacred Heart College (Autonomous), Tirupattur - 635601, Tamil Nadu, India.

Received: 29 Oct 2021

Revised: 21 Nov 2021

Accepted: 07 Jan 2022

### \*Address for Correspondence

**S.Savitha**

PG and Research Department of Mathematics,

Sacred Heart College (Autonomous),

Tirupattur - 635601, Tamil Nadu, India.

Email: ss2davs@gmail.com



This is an Open Access Journal / article distributed under the terms of the **Creative Commons Attribution License** (CC BY-NC-ND 3.0) which permits unrestricted use, distribution, and reproduction in any medium, provided the original work is properly cited. All rights reserved.

### ABSTRACT

In this study, a stochastic model is created for evaluating the direct effect of viral infusion on disease cell improvement. The first order statistical measures of the cells were estimated using a trivariate Probability function derived from the difference differential circumstances. This evaluation model might aid in the development of a new treatment time for oncolytic virotherapy.

**Keywords:** Stochastic model, Oncolytic virotherapy, Poisson process, First order statistical measures.

### INTRODUCTION

Cancer is an illness in which a portion of the body's cells develop out of control and spread to other tissues. Malignancy can begin anywhere in the human body's billions of cells. Human cells create and segment (an association known as cell division) to make new cells as the body requires. At the point when cells die or become harmed, they are supplanted by new ones. When this deliberate cycle separates, strange or harmed cells arise and increase when they shouldn't. These cells might frame tissue developments. Growths can be harmful or non-carcinogenic (harmless). Carcinogenic malignancies can move into or attack nearby tissues, as well as travel to distant parts of the body to frame new growths (a cycle called metastasis). Dangerous cancers are another name for destructive growths. Many cancers form powerful growths, while blood cancers, such as leukemias, do not.

Oncolytic virotherapy is a cancer treatment approach that employs skilled replicating infections to eradicate cancer cells. This research has progressed from previous perceptions of unintended viral diseases, resulting in a decrease in the number of malignancies caused by infection medications that target and kill malignant growth cells. The concept of using infections to treat tumours has been around for more than a century. Kendal (1960)[1] used an immediate birth and passing cycle to portray an advancement of growth by expecting the probabilities of birth and ruin are





**Vijaya and Savitha**

consistent and are independent. In 1986 [2], Birkhead proposed stochastic model using birth and passing collaboration with unconstrained mutation. In 2004, [3] Rao K.S and Rao P.T developed a stochastic Model for sickness cell improvement with unconstrained change and duplication. In 2006, Rao K.S and Rao P.T developed a Two stage stochastic Model for Cancer cell improvement. In the paper of Rao P.T, K.Madhavi and S.K Masthan Babu [4](2011), they have made stochastic model for freak cell advancement under chemotherapy with the assumption that the impact of medicine has particular reasonability scales and basically stochastic during t in view of various records. The similar dispute is contacted the Normal, Malformed and Malignant cells under the presence of OV. A Trivariate stochastic Model for the advancement of growth cell under the presence of viral therapy is made using the first order moments and the effect on the cancer cell inside seeing the viral implantation is explored.

**ASSUMPTIONS OF THE STOCHASTIC MODEL**

The following assumptions are considered to develop the stochastic model. Let us suppose that the trials considered without overlapping be statistically independent. Let  $\Delta\tau$  be an infinitesimal interval of time. At time  $\tau$ , suppose there are ' $\mu$ ' normal cells, ' $\omega$ ' malformed cells, and ' $\theta$ ' malignant cells. Let  $\alpha_{ab}$  be the growth rate,  $\beta_{bc}$  be the speed with which cells convert from c to c+1 stage,  $\gamma_{ab}$  be the death rate of cells, where 'a' be the stage of cells, a=1,2,3 for normal, malformed, malignant cells respectively, 'b = 1' be the presence of the viral injection and 'c' be the cell transformation from c to c+1 stage, c = 1,2. Assume that all of the above occurrences are governed by the Poisson Process.

**ANALYSIS OF THE MODEL**

Let  $\{P(\tau), \tau \geq 0\}, \{Q(\tau), \tau \geq 0\}, \{R(\tau), \tau \geq 0\}$  be the individual stochastic processes of Normal cells, Malformed cells and Malignant cells such that  $P\{P(\tau) = \mu\} = P_\mu(\tau)$ ,  $P\{Q(\tau) = \omega\} = P_\omega(\tau)$  and  $P\{R(\tau) = \theta\} = P_\theta(\tau)$  and the joint process will be  $P\{P(\tau), Q(\tau), R(\tau) = (\mu, \omega, \theta)\} = p_{\mu, \omega, \theta}(\tau)$ . In the presence of viral injection, the likelihood of production of one normal cell to another normal cell, the likelihood of production of one normal cell to one malformed cell, the likelihood of production of one malformed cell to another malformed cell, the likelihood of production of one malformed cell to one malignant cell, the likelihood of production of one malignant cell to another malignant cell at the time  $\tau$  be

$$\begin{aligned} &\mu\alpha_{11}\Delta\tau + o(\Delta\tau), \mu\beta_{11}\Delta\tau + o(\Delta\tau), \\ &\omega\alpha_{21}\Delta\tau + o(\Delta\tau), \omega\beta_{21}\Delta\tau + o(\Delta\tau), \\ &\theta\alpha_{31}\Delta\tau + o(\Delta\tau) \end{aligned}$$

respectively.

- One normal cell's probability of dying during  $\Delta\tau = \mu\gamma_{11}\Delta\tau + o(\Delta\tau)$ .
- One malformed cell's probability of dying during  $\Delta\tau = \omega\gamma_{21}\Delta\tau + o(\Delta\tau)$ .
- One malignant cell's probability of dying during  $\Delta\tau = \theta\gamma_{31}\Delta\tau + o(\Delta\tau)$ .

Probability of no generation of normal cell to normal cell, from normal to malformed, from normal cell to malignant cell, from malformed to malformed, from malformed to malignant, from malignant cell to malignant cell, no death of normal cell, malformed cell, malignant cell is

$$1 - [\mu(\alpha_{11} + \beta_{11} + \gamma_{11}) + \omega(\alpha_{21} + \beta_{21} + \gamma_{21}) + \theta(\alpha_{31} + \gamma_{31})]\Delta\tau + o(\Delta\tau).$$

Other events have a chance to happen with  $o(\Delta\tau)^2$ . The difference differential equation of the model is

$$\begin{aligned} p'_{\mu, \omega, \theta}(\tau) = & -[\mu(\alpha_{11} + \beta_{11} + \gamma_{11}) + \omega(\alpha_{21} + \beta_{21} + \gamma_{21}) + \theta(\alpha_{31} + \gamma_{31})]p_{\mu, \omega, \theta}(\tau) + (\mu - 1)\alpha_{11}p_{\mu-1, \omega, \theta}(\tau) + (\mu \\ & + 1)\gamma_{11}p_{\mu+1, \omega, \theta}(\tau) + (\omega - 1)\alpha_{21}p_{\mu, \omega-1, \theta}(\tau) + (\omega + 1)\gamma_{21}p_{\mu, \omega+1, \theta}(\tau) + (\theta - 1)\alpha_{31}p_{\mu, \omega, \theta-1}(\tau) \\ & + (\theta + 1)\gamma_{31}p_{\mu, \omega, \theta+1}(\tau) + (\mu + 1)\beta_{11}p_{\mu+1, \omega-1, \theta}(\tau) + (\omega + 1)\beta_{21}p_{\mu, \omega+1, \theta-1}(\tau) \end{aligned}$$





Vijaya and Savitha

$$\text{for } \mu, \omega, \theta \geq 1. \tag{1}$$

At  $\mu = 1, \omega = 0, \theta = 0$

$$p'_{1,0,0}(\tau) = -[(\alpha_{11} + \beta_{11} + \gamma_{11})]p_{1,0,0}(\tau) + 2\gamma_{11}p_{2,0,0}(\tau) + \gamma_{21}p_{1,1,0}(\tau) + \gamma_{31}p_{1,0,1}(\tau). \tag{2}$$

At  $\mu = 0, \omega = 1, \theta = 0$

$$p'_{0,1,0}(\tau) = -[(\alpha_{21} + \beta_{21} + \gamma_{21})]p_{0,1,0}(\tau) + \gamma_{11}p_{1,1,0}(\tau) + 2\gamma_{21}p_{0,2,0}(\tau) + \gamma_{31}p_{0,1,1}(\tau) + \beta_{11}p_{1,0,0}(\tau). \tag{3}$$

At  $\mu = 0, \omega = 0, \theta = 1$

$$p'_{0,0,1}(\tau) = -[(\alpha_{31} + \gamma_{31})]p_{0,0,1}(\tau) + \gamma_{11}p_{1,0,1}(\tau) + \gamma_{21}p_{0,1,1}(\tau) + 2\gamma_{31}p_{0,0,2}(\tau) + \beta_{21}p_{0,1,0}(\tau). \tag{4}$$

At  $\mu = 1, \omega = 1, \theta = 0$

$$p'_{1,1,0}(\tau) = -[(\alpha_{11} + \beta_{11} + \gamma_{11}) + (\alpha_{21} + \beta_{21} + \gamma_{21})]p_{1,1,0}(\tau) + 2\gamma_{11}p_{2,1,0}(\tau) + 2\gamma_{21}p_{1,2,0}(\tau) + \gamma_{31}p_{1,1,1}(\tau) + 2\beta_{11}p_{2,0,0}(\tau). \tag{5}$$

At  $\mu = 1, \omega = 0, \theta = 1$

$$p'_{1,0,1}(\tau) = -[(\alpha_{11} + \beta_{11} + \gamma_{11}) + (\alpha_{31} + \gamma_{31})]p_{1,0,1}(\tau) + 2\gamma_{11}p_{2,0,1}(\tau) + \gamma_{21}p_{1,1,1}(\tau) + 2\gamma_{31}p_{1,0,2}(\tau) + \beta_{21}p_{1,1,0}(\tau). \tag{6}$$

At  $\mu = 0, \omega = 1, \theta = 1$

$$p'_{0,1,1}(\tau) = -[(\alpha_{21} + \beta_{21} + \gamma_{21}) + (\alpha_{31} + \gamma_{31})]p_{0,1,1}(\tau) + \gamma_{11}p_{1,1,1}(\tau) + 2\gamma_{21}p_{0,2,1}(\tau) + 2\gamma_{31}p_{0,1,2}(\tau). \tag{7}$$

At  $\mu = 0, \omega = 0, \theta = 0$

$$p'_{0,0,0}(\tau) = \gamma_{11}p_{1,0,0}(\tau) + \gamma_{21}p_{0,1,0}(\tau) + \gamma_{31}p_{0,0,1}(\tau). \tag{8}$$

with  $P_{P_0, Q_0, R_0}(\tau) = 1, p_{a,b,c}(\tau) = 0, \forall a \neq P_0, b \neq Q_0, c \neq R_0$ , where  $P_0, Q_0, R_0$  are the initial sizes of normal, malformed and malignant cells.

Let  $p(u, v, w, \tau)$  be the joint probability generating function of  $p_{\mu,\omega,\theta}(\tau)$ .

$$p(u, v, w, \tau) = \sum_{\theta=0}^{\infty} \sum_{\omega=0}^{\infty} \sum_{\mu=0}^{\infty} u^{\mu} v^{\omega} w^{\theta} p_{\mu,\omega,\theta}(\tau) \tag{9}$$

$$\begin{aligned} \frac{\partial}{\partial \tau} p(u, v, w, \tau) &= u \sum_{\theta=1}^{\infty} \sum_{\omega=1}^{\infty} \sum_{\mu=1}^{\infty} u^{\mu} v^{\omega} w^{\theta} \left[ -[\mu(\alpha_{11} + \beta_{11} + \gamma_{11}) + \omega(\alpha_{21} + \beta_{21} + \gamma_{21}) + \theta(\alpha_{31} + \gamma_{31})] \right] p_{\mu,\omega,\theta}(\tau) + \\ &(\mu - 1)\alpha_{11} p_{\mu-1,\omega,\theta}(\tau) + (\mu + 1)\gamma_{11} p_{\mu+1,\omega,\theta}(\tau) + (\omega - 1)\alpha_{21} p_{\mu,\omega-1,\theta}(\tau) \\ &(\omega + 1)\gamma_{21} p_{\mu,\omega+1,\theta}(\tau) + (\theta - 1)\alpha_{31} p_{\mu,\omega,\theta-1}(\tau) + (\theta + 1)\gamma_{31} p_{\mu,\omega,\theta+1}(\tau) \\ &(\mu + 1)\beta_{11} p_{\mu+1,\omega-1,\theta}(\tau) + (\omega + 1)\beta_{21} p_{\mu,\omega+1,\theta-1}(\tau) \end{aligned} \tag{10}$$





Vijaya and Savitha

$$\begin{aligned} \frac{\partial}{\partial \tau} p(u, v, w, \tau) &= (\alpha_{11} + \beta_{11} + \gamma_{11})u \sum_{\theta=1}^{\infty} \sum_{\omega=1}^{\infty} \sum_{\mu=1}^{\infty} -\mu u^{\mu-1} v^{\omega} w^{\theta} p_{\mu, \omega, \theta}(\tau) - (\alpha_{21} + \beta_{21} + \gamma_{21})v \sum_{\theta=1}^{\infty} \sum_{\omega=1}^{\infty} \sum_{\mu=1}^{\infty} \omega u^{\mu} v^{\omega-1} w^{\theta} p_{\mu, \omega, \theta}(\tau) \\ &+ (\alpha_{31} + \gamma_{31})w \sum_{\theta=1}^{\infty} \sum_{\omega=1}^{\infty} \sum_{\mu=1}^{\infty} -\theta u^{\mu} v^{\omega} w^{\theta-1} p_{\mu, \omega, \theta}(\tau) + \alpha_{11}u^2 \sum_{\theta=1}^{\infty} \sum_{\omega=1}^{\infty} \sum_{\mu=1}^{\infty} (\mu - 1)u^{\mu-2} v^{\omega} w^{\theta} p_{\mu-1, \omega, \theta}(\tau) + \\ &\gamma_{11} \sum_{\theta=1}^{\infty} \sum_{\omega=1}^{\infty} \sum_{\mu=1}^{\infty} (\mu + 1)u^{\mu} v^{\omega} w^{\theta} p_{\mu+1, \omega, \theta}(\tau) + \alpha_{21}uv \sum_{\theta=1}^{\infty} \sum_{\omega=1}^{\infty} \sum_{\mu=1}^{\infty} (\omega - 1)u^{\mu-1} v^{\omega-1} w^{\theta} p_{\mu, \omega-1, \theta}(\tau) + \\ &\gamma_{21} \sum_{\theta=1}^{\infty} \sum_{\omega=1}^{\infty} \sum_{\mu=1}^{\infty} (\omega + 1)u^{\mu} v^{\omega} w^{\theta} p_{\mu, \omega+1, \theta}(\tau) + \alpha_{31}v^2 \sum_{\theta=1}^{\infty} \sum_{\omega=1}^{\infty} \sum_{\mu=1}^{\infty} (\theta - 1)u^{\mu} v^{\omega} w^{\theta} p_{\mu, \omega, \theta-1}(\tau) + \\ &\gamma_{31} \sum_{\theta=1}^{\infty} \sum_{\omega=1}^{\infty} \sum_{\mu=1}^{\infty} (\theta + 1)u^{\mu} v^{\omega} w^{\theta} p_{\mu, \omega, \theta+1}(\tau) + \beta_{11}vw \sum_{\theta=1}^{\infty} \sum_{\omega=1}^{\infty} \sum_{\mu=1}^{\infty} (\mu + 1)u^{\mu} v^{\omega-1} w^{\theta} p_{\mu+1, \omega-1, \theta}(\tau) \\ &+ \beta_{21}w^2 \sum_{\theta=1}^{\infty} \sum_{\omega=1}^{\infty} \sum_{\mu=1}^{\infty} u^{\mu} v^{\omega} w^{\theta-2} p_{\mu, \omega+1, \theta-1}(\tau) \end{aligned}$$

Rearranging the terms,

$$\begin{aligned} \frac{\partial}{\partial \tau} p(u, v, w, \tau) &= \\ [- (\alpha_{11} + \beta_{11} + \gamma_{11})u + \alpha_{11}u^2 + \gamma_{11} + \alpha_{21}uv] \frac{\partial}{\partial u} p(u, v, w, \tau) &+ [ - (\alpha_{21} + \beta_{21} + \gamma_{21})v + \gamma_{21} + \\ \alpha_{31}v^2] \frac{\partial}{\partial v} p(u, v, w, \tau) + [ - (\alpha_{31} + \gamma_{31})w + \beta_{21}w^2] \frac{\partial}{\partial w} p(u, v, w, \tau) & \end{aligned} \tag{11}$$

Using the joint cumulant generating functions of  $p_{\mu, \omega, \theta}(\tau)$ , to obtain its properties,

Take  $u = e^x, v = e^y, w = e^z$  and let  $K(x, y, z, \tau)$  be the joint cumulant generating functions of  $p_{\mu, \omega, \theta}(\tau)$ .

From (11)

$$\begin{aligned} \frac{\partial}{\partial \tau} K(x, y, z, \tau) &= [ - (\alpha_{11} + \beta_{11} + \gamma_{11}) + \alpha_{11}e^x + \gamma_{11}e^{-x} + \alpha_{21}e^y + \\ \gamma_{21}e^{-y} + \beta_{11}e^{z-y}] \frac{\partial K}{\partial y} + [ - (\alpha_{31} + \gamma_{31}) + \beta_{21}e^z] \frac{\partial K}{\partial z} &+ [ - (\alpha_{21} + \beta_{21} + \gamma_{21}) + \alpha_{31}e^y + \end{aligned} \tag{12}$$

Let  $S_{a,b,c}(\tau)$  denotes orderly moments and a,b,c denotes normal, malformed and malignant cells at time  $\tau$ .

Equating the coefficients of x's, y's and z's. We get

$$\frac{\partial}{\partial \tau} S_{1,0,0}(\tau) = (\alpha_{11} - \gamma_{11} - \beta_{11})S_{1,0,0}(\tau) \tag{13}$$

$$\frac{\partial}{\partial \tau} S_{0,1,0}(\tau) = \beta_{11}S_{1,0,0}(\tau) + (\alpha_{21} - \gamma_{21} - \beta_{21})S_{0,1,0}(\tau) \tag{14}$$

$$\frac{\partial}{\partial \tau} S_{0,0,1}(\tau) = \beta_{21}S_{0,1,0}(\tau) + (\alpha_{31} - \gamma_{31})S_{0,0,1}(\tau) \tag{15}$$

Solving the above equations, we get

Average number of normal cells at ' $\tau$ ':

$$S_{1,0,0}(\tau) = N_0 e^{A\tau}$$

$$S_{1,0,0}(\tau) = N_0 e^{(\alpha_{11} - \beta_{11} - \gamma_{11})\tau} \tag{16}$$

where  $N_0$  is the initial size of normal cells and  $A = \alpha_{11} - \beta_{11} - \gamma_{11}$





Vijaya and Savitha

Average Number of malformed cells at time 'τ':

$$S_{0,1,0}(\tau) = \frac{\beta_{11}N_0}{A-B} [e^{A\tau} - e^{B\tau}] + M_0 e^{B\tau}$$

$$S_{0,1,0}(\tau) = \frac{\beta_{11}N_0}{\alpha_{11}-\beta_{11}-\gamma_{11}-\alpha_{21}+\beta_{21}+\gamma_{21}} [e^{(\alpha_{11}-\beta_{11}-\gamma_{11})\tau} - e^{(\alpha_{21}-\beta_{21}-\gamma_{21})\tau}] + M_0 e^{(\alpha_{21}-\beta_{21}-\gamma_{21})\tau} \tag{17}$$

Average Number of malignant cells at time 'τ':

$$S_{0,0,1}(\tau) = \frac{\beta_{11}\beta_{21}N_0 e^{c\tau}}{\alpha_{11}-\beta_{11}-\gamma_{11}-\alpha_{21}+\gamma_{21}+\beta_{21}} \left[ \frac{e^{(A-C)\tau}}{A-C} - \frac{e^{(B-C)\tau}}{B-C} \right] + \frac{\beta_{21}M_0 e^{B\tau}}{B-C} + \frac{\beta_{21}e^{c\tau}}{\alpha_{21}-\gamma_{21}-\beta_{21}-\alpha_{31}+\gamma_{31}} \tag{18}$$

where  $A = \alpha_{11} - \beta_{11} - \gamma_{11}$ ,  $B = \alpha_{21} - \beta_{21} - \gamma_{21}$ ,  $C = \alpha_{31} - \gamma_{31}$

**ILLUSTRATION**

The values accepted here are taken arbitrarily under specific suspicions and it tends to be changed. The aftereffect of the moments depends correspondingly. For the particular values of the parameters and varying the normal cells under virotherapy, the analysis has been done and given below. In the first figure, all the parameters values are fixed and the values of normal cells were varied, and the moment for the normal cells were plotted. The second figure represents the variation of the death of the malformed cells keeping all the other parameters fixed, the moment of the number of the malformed cells were evaluated. The third figure represents the variation of the death of the malignant cells keeping all the other parameters fixed, the moment of the number of the malignant cells were evaluated.

**CONCLUSION**

The average number of Normal cells grows at time 't' under the continuous observation of virotherapy, as shown in the preceding analysis. With the continual presence of Oncolytic virotherapy, the number of malformed and malignant cell deaths also increases. It has been discovered that the spread of cancerous cells can be slowed. The virotherapy can be investigated and analysed by researchers in the developing era of cancer therapeutics to lower the threat of cancer, and this model might be extended to further study with the analysis conducted using the second order moments.

**REFERENCES**

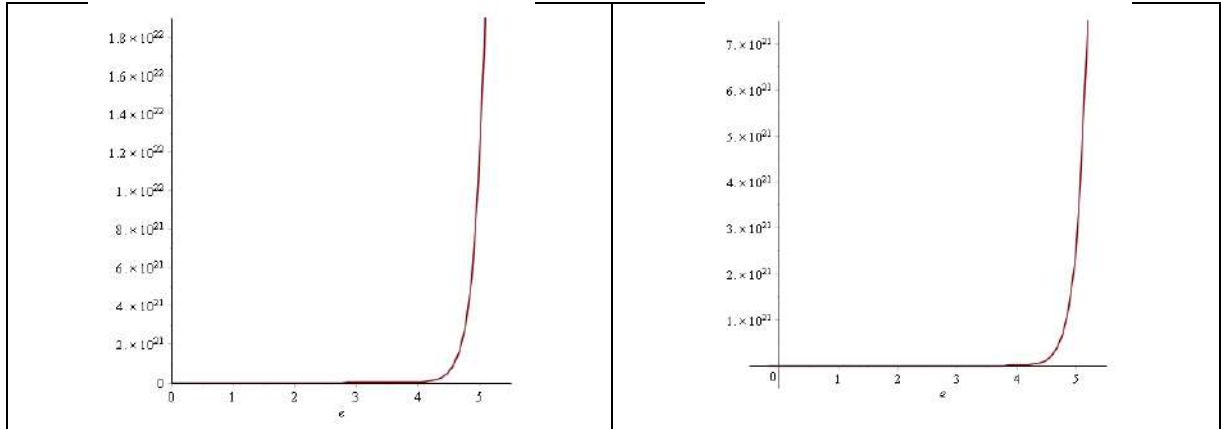
1. D.G. Kendall.,(1960),"Birth and Death Processes and the theory of Carcinogenesis",Biometrics,47,13-121.
2. B.G. Birkhead.,(1986),"The Transient Solution of the linear Birth, Death Process with Random Spontaneous Mutation", Math.BioSci.,82,193-200.
3. P.T.Rao., and K.S.Rao.,(2004), "Stochastic Model for Cancer Cell Growth and Spontaneous Mutation and Proliferation", International Journal of Management and Systems, 20(1),85-93.
4. P.T.Rao., and K.S.Rao.,(2006), "Two Stage Stochastic Model for Cancer Cell Growth", Indian Journal of Mathematics and Mathematical Sciences, 2(2),153-168.
5. P.T.Rao., S.K.Masthan Babu.,and K.Madhavi.,(2011), "Bivariate Stochastic Modeling for Malformed cell Growth under Chemotherapy", International Journal of Mathematics and Applications, 4(1),1-12.
6. Abundo, M., Rossi, C: Numerical simulation of a stochastic model for cancerous cells submitted to chemotherapy. Journal of Mathematical Biology. 27, 81-90 (1989)
7. John Carl Panetta: A mathematical model of drug resistance: Heterogeneous tumors. Mathematical Biosciences. 147, 41-61 (1998).





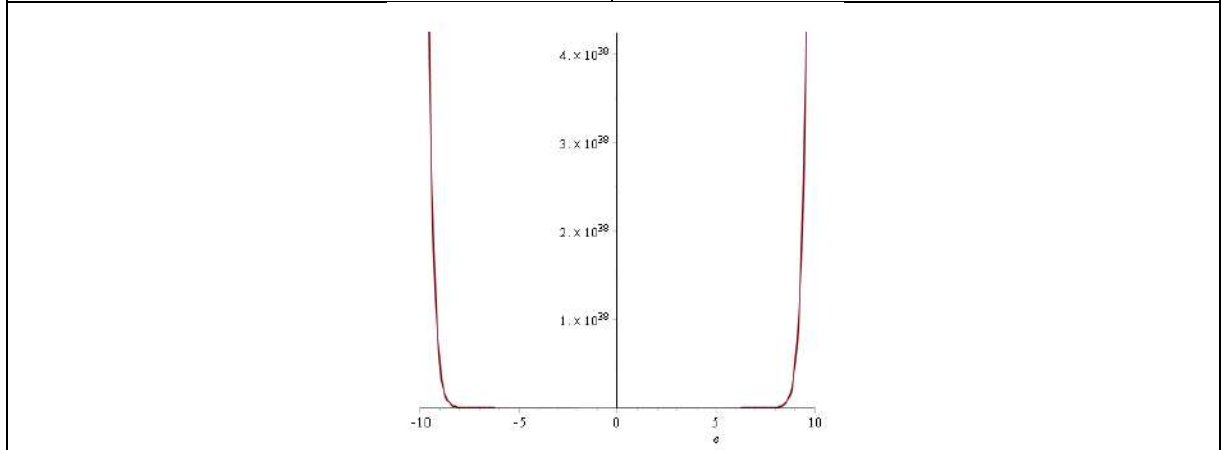


**Vijaya and Savitha**



**Figure 1. Average Number of Normal cells**

**Figure 2. Average Death of Malformed cells**



**Figure 3. Average Death of Malignant cells**





## An Application of Nanobots for Improving the Quality of Medical Treatments

A.Vignesh<sup>1</sup> and N.Vijayalakshmi<sup>2\*</sup>

<sup>1</sup>Assitant Professor, Department of Computer Science, Faculty of Science and Humanities, SRM Institute of Science and Technology, Ramapuram - 89, Tamil Nadu, India.

<sup>2</sup>Assistant Professor, Department of Computer Applications, Faculty of Science and Humanities, SRM Institute of Science and Technology, Ramapuram - 89, Tamil Nadu, India.

Received: 08 Nov 2021

Revised: 15 Dec 2021

Accepted: 11 Jan 2022

### \*Address for Correspondence

#### N.Vijayalakshmi

Assistant Professor,  
Department of Computer Applications,  
Faculty of Science and Humanities,  
SRM Institute of Science and Technology,  
Ramapuram - 89, Tamil Nadu, India.  
Email: vijayaln@srmist.edu.in



This is an Open Access Journal / article distributed under the terms of the **Creative Commons Attribution License** (CC BY-NC-ND 3.0) which permits unrestricted use, distribution, and reproduction in any medium, provided the original work is properly cited. All rights reserved.

### ABSTRACT

The aim of this analysis is to analyze the phenomenon of nano robotics at a global level. Nano robotics can still be applicable to micro and tiny robotics. These nanobots offer a variety of advantages, including access to previously inaccessible and constrained areas, enhanced flexibility, usefulness, and endurance, and inexpensive, flexible, and distributed deployment. More specifically. To become much more specific Nano robots are now a conceptual idea since no artificial non-biological Nano robots have been developed. Nanobots, ganoids, nanites, and nanomites are all terms that have been used to characterise these hypothetical devices. The main objective of this work is to examine certain nanorobotics applications, such as micro robots, developing drug delivery applications, health care, and biomedical applications

**Keywords:** Nano robotics, artificial, applications, robotics, biomedical.

### INTRODUCTION

The construction of a fully mechanical machine having physical or component properties on the nanoscale scale is known as nanotechnology. Nanorobotics is a word used to describe this sort of technology. Everything which exists are ideas. Morph is the name given to these types of mobile phones. Robotics is frequently employed in a variety of areas, including communication, transportation, the military, commerce, and medicine A nano robot is a computer-



**Vignesh and Vijayalakshmi**

controlled robotic device that is microscopic in size and constructed of nanoscale components using molecular precision. We can utilize this technology to the design of splitting mechanics and human safety measures. Robotics is a promising development today, as Nanotechnology progresses and continues to study, construct, and create new robots for a range of different uses, whether household or military.

**Overview and Application of Nanorobots**

Richard Smalley enlarged his vision in the 1980s that included carbon nano tubes, and has envisioned that the upcoming generations will be connected through tiny devices. Nanotechnology has definitely assisted in the manipulation of elements to prepare different and largely successful structures. Micro robotics, emerging drug delivery applications, health care, bio-medical applications, cancer therapy, brain aneurysm, communication system, and new future Nano technologies are among some of the usage of Nano robotics Etc.

**Application of Nanomedicine**

The much more major development in nano medicine has been molecular nanotechnology or nanorobotics. Likewise to how biotechnology expands the range and efficacy of treatments available from nanomaterials, the introduction of nanotechnology biomolecules will significantly increase the success, precision, and speed of future medical treatments while significantly decreasing their risk, cost, and invasiveness. The nano robots have been injected into the patient to perform treatment. In future these nano medicine will play an vital role.

**Nanorobotics uses In Healthcare**

Nano robots are expanding at a rapid pace in the medical field. As a response, the domains of human safety and health care are expanding. There seem to be numerous senior ill individuals who are survived because to the nanorobotical treatment method. At the cellular level, Nano robots will treat and find disease, and also rebuild missing tissue. It could be used to monitor, detect, and manage sickness. Nanorobotics is doing good treatment through biological in the health care field. That is, the technology of therapeutic interventions is being improved. We'll see a decrease in massive diseases in the future.

**Nano Robots In Cancer Treatment**

With the use of nanorobotics, cancer can often be successfully treated using established health technologies and therapy methods. The invention and implementation of tailored medication delivery to prevent chemotherapy side effects is another crucial component in achieving a successful treatment for patients. Embedded Nano sensors are generally used to evaluate the intensity of E-cadherin signals. As a result, for the deployment of Nano robots for cancer therapy, a hardware architecture has been developed and performed the task successfully. Salmonella bacteria have been genetically engineered to attract cancer cells by releasing contaminants. When the bacteria reach the tumour, microscopic robots with a width of around 3 micrometres release capsules containing drugs. The invention and implementation of customized drug delivery to reduce chemotherapy side effects is another critical factor in achieving a successful treatment for patients. Nano robots will be able to assist with such essential role in cancer treatment due to their ability to traverse as blood-borne electronics.

**Nanorobots For Biomedical Applications**

Nano-Robots' enormous physiological potential, and hence the imprecision and fewer side effects of today's medical therapies, made them especially appealing. Nonetheless, we recommend Nano medical robots today since they will have no trouble detecting target site cells at any point, which is unachievable with primary therapy, and will be able to track them down and eliminate them or where they are expanding in the future.

**Nano Robots In Genetherapy**

Biomedical the molecular structures of DNA and proteins found within the cell are get analyzed to identify the desired reference structures. For identifying these we use the nano robots with genetic disorders. In some circumstances, chromosomal replacement therapy is more effective at replacing genomes than micro array therapy. A genetic maintenance vessel created by discrete components hovers inside the nucleus of a person's cell. The Nano



**Vignesh and Vijayalakshmi**

machine gently clears the wound and analysis the minute partials with the help of robot arms. At the molecular level, cancer, viral infections, and arteriosclerosis may be depleted. The lot of human diseases are caused by defects that are observed in the cellular level.

**Brain Aneurysm Nanorobot**

They're using computational nanotechnology for medical device prototyping using the Nano robot for brain aneurysm prognosis. This is made up of 3 primary pieces of equipment

1. Prototyping
2. Manufacturing
3. inside-body transduction.

Computational nanotechnology is a crucial tool for the rapid and successful development of Nano robots, and it aids research into major parts of medical instruments and device prototype.

**Demerits of Nanobots**

The Nano robot's design is extremely difficult. Electrical systems can generate stray fields that can trigger molecular recognition systems that are based on bioelectrics. In the field of terrorism, nano robots pose a serious threat. Terrorism and anti-groups can employ Nano robots to kill populations instead of torturing them, since nanotechnology has the capacity to eliminate the physical body at the molecular level. Nano robots could also pose a threat to privacy. Since Nano robots are engaged in the construction of small and compact electronics, there is the potential for even greater eavesdropping than is already feasible. It consumes high cost

**Merits of Nanobots**

At this current situation there is no proper vaccination is available to cure the disease. They are only providing treatment to extend the life span of the patient. The development of this Nano robot will inspire people to seek treatment in order to cure their ailment. There are no negative impacts because the Nano robot does not generate any harmful activities. It only works at a specified location

**CONCLUSION**

Recent advances in nanoscale science, on the other hand, give cause to expect that this technology will be effective in medicine. With an overview of nano robots and their significance as seen by various technologists. Nanotechnology as a cancer and diabetes diagnostic and treatment tool demonstrated how current advances in nanotechnology have benefited cancer and diabetes patients. Manufacturing technologies are enabling new research that will aid in the most efficient development and application of Nano robots for biomedical applications. As a result, the pharmaceutical, biotechnology, diagnostic, and healthcare industries will have more product and marketing contacts. Sensitive new diagnostics will be employed in healthcare in the future to improve personal risk evaluation

**REFERENCES**

1. A source of the e-book "The Future with Nanotechnology
2. Micro- and Nano-Scale Robotics, Metin Sitti, Member, IEEE, ASME. Proceeding of the 2004 American Control Conference Boston, Massachusetts June 30-July 2, 2004.
3. NANOROBOTS: CURRENT STATE AND FUTURE PERSPECTIVES, \*Sonal Mazumder and Saket Bhargava, Department of Chemical Engineering, Birla Institute of Technology and Science- Pilani, Pilani Campus, Rajasthan 333031.
4. Nano-robotics-"a hope for future", smriti mathur, anshulagarwal, National Conference on Synergetic Trends in Engineering and Technology (STET-2014) International Journal of Engineering and Technical Research ISSN: 2321-0869, Special Issue





**Vignesh and Vijayalakshmi**

5. Nanomachines and Robots Developments and Applications, By Lindsey Armstrong, Christopher Arnold, Kamal Banjara, Ahmad Al-douah,
6. The role of engineering in nanotechnology, Dr. Michael Haji-Sheikh Electrical Engineering, Department Northern Illinois University
7. Current Status of Nanomedicine and Medical Nanorobotics , Robert A. Freitas, Jr. Institute for Molecular Manufacturing, Palo Alto, California, USA.
8. Anti-HIV using Nano Robots, Shrutthi Harrsha, V. Venkateswarra Rao, <sup>1</sup>Tata Consultancy Services, India. <sup>2</sup>Department of Electrical Engineering, Texas Tech University, U.S.A.
9. Nanorobots, Abhilash M, Department of Biotechnology, The Oxford college of Engineering, Bangalore, INDIA

<p><b>Fig 1. structure of aids virus</b></p>	<p><b>Fig : 2. Interaction of HIV with CD4 images</b></p>
<p><b>Fig 3. Cancer Tumor Killed By Nanobots</b></p>	<p><b>Fig 4. : Working of Nanorobot on Brain aneurysm</b></p>





## Current Scenario of Generic Drug Regulation and Registration Process in Latam (Latin American) Countries

Deeksha K S<sup>1</sup>, Balamuralidhara V<sup>2\*</sup> and M D Abbas Alam<sup>3</sup>

<sup>1</sup>Research Scholar, Department of Pharmaceutics, Regulatory Affairs Group, JSS College of Pharmacy, Mysuru, Karnataka, India

<sup>2</sup>Associate Professor, Department of Pharmaceutics, JSS College of Pharmacy, Mysuru Karnataka, India.

<sup>3</sup>M.Pharm, Department of Pharmaceutics, Regulatory Affairs Group, JSS College of Pharmacy, Mysuru, Karnataka, India.

Received: 14 Dec 2021

Revised: 29 Dec 2021

Accepted: 13 Jan 2022

### \*Address for Correspondence

#### Balamuralidhara V

Associate Professor,  
Department of Pharmaceutics,  
JSS College of Pharmacy,  
Mysuru Karnataka, India.



This is an Open Access Journal / article distributed under the terms of the **Creative Commons Attribution License** (CC BY-NC-ND 3.0) which permits unrestricted use, distribution, and reproduction in any medium, provided the original work is properly cited. All rights reserved.

### ABSTRACT

In spite of endeavours at territorial harmonization, the administrative procedure to get showcasing authorisation (MA) for drugs in Latin American (LATAM) nations is amazingly nation explicit. Mind boggling and evolving specially appointed solicitations from purchasers should be taken care of proactively to keep away from exorbitant postponements or show-stops to nearby item dispatches. This article offers a pharmaceutical administrative condition in LATAM to guarantee a fruitful worldwide administrative system, coming because of over a time of involvement with a biotech firm. The information on quality, wellbeing, and viability in the enlistment dossier has its own significance. Markets are developing in business significance internationally. It is significant for the pharmaceutical business to satisfy the administrative necessities for quality security and to guarantee its situation in the commercial center. Despite the fact that the Common Technical Document (CTD) of the International Conference on Harmonization (ICH) may fill in as a guide for most nearby MA Applications (MAA), it isn't really required completely. Moreover, a lot of compulsory & exceptionally nation explicit documentation requires vital arranging and designation for fruitful and opportune neighbourhood endorsements. Thorough recognizable proof of genuine prerequisites can show difficulties because of regular arrangement changes, vague desires and so on. Getting as a lot of early perceivability and control of LATAM nation explicit prerequisites and wellbeing specialists desires would enable the pharmaceutical business to improve groundwork for worldwide MAA, handle interior desires ideally,



**Deeksha et al.,**

and in particular furnish patients in the territory with quicker access to treatments and better personal satisfaction.

**Keywords:** Marketing authorization, Latin America (LATAM), Emerging markets, Pan American Network for Drug Regulatory Harmonization (PANDRH), Certificate of Pharmaceutical Product (CPP), Chemistry, Manufacturing and controls (CMC).

## INTRODUCTION

An growing of medicines are accessible in the world wide. Pharmaceuticals are needed to humans. Because in this world Human are widely affected by the numerous diseases. So to reduce that medicines are dedicated to make people alive & reduce the diseases [1]. Medicines are not available for poor people, because it is costly. So the other way to use the medicines is Generic medicines [2]. Through the availability and reasonableness of present day pharmaceuticals in worldwide social insurance frameworks, it assumes a crucial job in the treatment of ailment. Without the cost distinction for future and fundamental conventional medications are accessible to the same number of patients to guarantee security. The advantages of a solid and dynamic conventional prescriptions industry – truly and later on - are obvious. As of now over portion of the volume of prescriptions are provided as generics medications yet this speaks to only 18% in esteem terms [3].

### LATAM (Latin American) Pharmaceutical Market

Through the availability and reasonableness of present day pharmaceuticals in worldwide social insurance frameworks, it assumes a crucial job in the treatment of ailment. Without the cost distinction for future and fundamental conventional medications are accessible to the same number of patients to guarantee security. The advantages of a solid and dynamic conventional prescriptions industry – truly and later on - are obvious. As of now over portion of the volume of prescriptions are provided as generics medications yet this speaks to only 18% in esteem terms [4].

### Brazil

Brazil isn't only one of Latin America's biggest pharmaceutical markets however the entire world. Current development evaluates over the most recent few years have driven them to turn into a significant player on the world stage [5]. Brazil's medication industry is presently 6th in the nation and is relied upon to rank in the main 5 by 2021. Brazil, as a pharmaceutical market, is beating the UK, Italy, Canada and Spain and is required to pass France soon. The aggregate drug market in Brazil is expected to grow between 7 and 9.3 percent in 2018. Various companies have described Brazil as one of the world's most lucrative pharmaceutical markets. One principle forecast gauges Brazil's pharmaceutical market all in all to develop from \$25.3 billion of every 2016 to \$29.9 billion out of 2021 [6].

### Argentina

Albeit a significant part of the Brazil's economy has been ascending as of late, Argentina has been in recuperation mode, and right now pharmaceutical industry is the same. Argentina's pharmaceutical industry is anticipated to see a 1 percent expansion in deals in 2018, as indicated by ongoing appraisals. Argentine pharmaceutical fares are required to develop by 7 percent. Argentina's pharmaceutical market turnover is anticipated to increment by 20 percent more than 2017. Prescription drugs are additionally on the ascent in Argentina, with a figure increment of 27 percent for 2018. all in all, there is a developing interest for gifted representatives in pharmaceutical research, advancement, microbiology, quality control and research [7].



**Deeksha et al.,****Mexico**

Like Brazil, Mexico isn't only a huge pharmaceutical player in Latin America yet the whole world. A couple of figures point to the country to make colossal gains in the coming years. Mexico currently represents the world's 11th largest pharmaceutical market. At the 2017 Economic Outlook, one gauge anticipated that Mexico's medication industry should create from \$17 billion to over \$20 billion by 2020. Generics are a huge piece of the medication business in Mexico, representing 9 out of each 10 deals of medications. Conventional deals of medications in Mexico have grown 11 percent every year throughout the most recent 5 years [8].

**Colombia**

In spite of the fact that not as enormous with everything taken into account as a portion of the other Latam markets, Colombia is one of a kind in that it has incredible potential for development in coming years. For all Latin American countries its development is anticipated to be close the top. Overall, between 2017 and 2019 the Colombian pharmaceutical sector is expected to grow by 25 percent. Prescription drugs contribute essentially towards this sum, 83 percent of the all out market. Overall, the Pharmaceutical area in Colombia is evaluated at \$4.9 billion of every 2018. The sector is responsible for developing 25,000 jobs in the country [9]. Geographically LATAM Pharmaceutical Market is distributed in following three regions.

**Caribbean region**

North American region

South American region[10]

Countries in Caribbean region

1. Cuba
2. Haiti
3. Dominican Republic
4. Jamaica
5. Trinidad & Tobago
6. Bahamas
7. Barbados
8. Saint Lucia
9. Grenada
10. St. Vincent & Grenadines
11. Antigua & Barbuda
12. Dominica
13. Saint kitts & Nevis

**Countries in North American region**

1. Mexico
2. Guatemala
3. Honduras
4. Nicaragua
5. El Salvador
6. Costa Rica
7. Panama
8. Belize

**Countries in South American region**

1. Brazil
2. Colombia
3. Argentina
4. Peru







Deeksha et al.,

5. Venezuela
6. Chile
7. Ecuador
8. Bolivia
9. Paraguay
10. Uruguay
11. Guyana
12. Suriname

### **The Latin American regulatory framework (LATAM) can be separated into 3 categories**

1. Nations that have created rules (Brazil, Chile, Mexico, and Venezuela) to show the adequacy, security by means of clinical examinations, and restorative derivation tries different things with proper administrative endorsement forms.
2. The locales (Argentina, Columbia, Ecuador, Paraguay) that have the standards for enlisting another medication or biosimilars yet not as severe as the primary gathering [11].
3. The locales (Guatemala, Barbados, Bolivia, Nicaragua, and Peru) that have not entirely evolved tranquilize endorsement rules. Key Drivers of LATAM Pharmaceutical market are:

1. Brazil
2. Mexico
3. Argentina
4. Venezuela
5. Chile
6. Colombia
7. Peru

### **Generic Drug Registration Process in Dominican Republic**

The Dominican Republic has a National Medicines Policy (Politica Farmaceutica Nacional) officially approved, dated 2005. A public sector implementation plan is available, and a regionalseminar is arranged for this year to develop the private sector implementation plan. The National Medicines Policy provides a detailed pharmaceutical industry situation study. The three main goals are: ensuring accessibility to appropriate drugs for the population, focusing on those of public health importance and the Dominican Social welfare system to promise the quality, safety and efficacy of medicines circulating in the country; Promoting and developing strategies to promote the growth of a culture of legitimate medicinal use.[12]

#### **Licensing**

##### **Licensing of Premises**

Within the DGDF the department for pharmaceutical establishments is responsible for registration and authorization of pharmaceutical establishments. Conditions are established in the Medicines Regulations and partially available on the Ministry of Health webpage ([www.sespas.gov.do](http://www.sespas.gov.do)). The system is deconcentrated to the provincial Ministry of Health directorates. These directorates are supervised monthly. Inspections are conducted before licenses are issued, and for renewal of licenses. The Pharmacy Board, an external advisory committee<sup>14</sup>, advises on issues related to authorization of pharmacies. Farmacias del Pueblo operated under PROMESE/CAL are authorized automatically. Approximately 70% of these pharmacies operate under the direction of a pharmacist. [13]

##### **Import Permits**

Import permits are required for the import of pharmaceutical products. These are issued subject to presentation of the written acknowledgement by DGDF that the importing agency is registered as a pharmaceutical establishment, and that the product to be imported is included in the medicines register ("Reconocimiento Sanitario para los Fines





Deeksha et al.,

Aduanales”), and a GMP certificate for the manufacturing plant and a Certificate of Free Sale provided by the importer. As per Medicines Regulations the DGDF also authorizes imports of unregistered medicines for use for a specific patient, for investigational use, for donations, and in cases of emergencies [13].

**Applications for registration** have to be submitted on standard application forms (available on the Ministry of Health website). Applications have to be accompanied by samples of the finished product. The following technical information/documentation is currently required to accompany the application for 'known' products:

- GMP Certificate (plus Free Sale Certificate for imported products)
- INN and declaration of exchange mark (if appropriate)
- Complete qualitative and quantitative composition
- Pharmacological classification (ATC)
- Dosage structure, technique for organization, and bundle
- Indication, contraindications, alerts, and precautionary measures
- For each active ingredient: INN, chemical formula, molecular weight and information regarding the manufacturer(s)
- Chemical, pharmaceutical and biological information
- Complete composition including active ingredients, excipients, coating material etc.
- Monograph
- Method of manufacturing
- Quality control methods (including starting materials, in-process, and final product)
- Packaging material specifications
- Shelf-life and storage conditions (including stability studies) Original quality control certificate of finished product
- Documentation on how to dispose of unused product
- Conditions for use and dispensing
- Original quality control certificate of finished product
- Documentation on how to dispose of unused product
- Conditions for use and dispensing

**For new products the following additional information is required**

- Clinical studies and preliminaries (distributed and non-distributed) including study conventions (counting reads for adequacy a wellbeing)
- Clinical pharmacology establishing pharmacodynamic and pharmacokinetic properties (active ingredient and metabolites), interactions, and clinical efficacy and safety
- Instant of method of act
- Toxicity data, studies establishing carcinogen and mutagen potential, and effects on the reproductive system

Specific additional requirements are documented for biological products.

Except for biological products samples are analyzed at the National Public Health Laboratory Dr Defillo. Registration will only be granted if a positive test result is obtained. Registration is subject to renovation every 5 years.

Fees are charged for registration related services. Examples are provided ( Table 2). There is no independent appellate body. Applicants can submit an official complaint to the Director General DGDF. If the conflict is not being resolved further complaints will proceed using the established administrative procedures [13].

**Generic Drug Registration Process in Jamaica**

The focal office of the Ministry of Health is answerable for approaches, standard setting, examination and observing, and the improvement of projects. Wellbeing segment decentralization started with the formation of 4 Regional Health Authorities in 1996. Hence, the limit with respect to dynamic was expelled from singular medical clinics and areas and moved to the specialists. Numerous jobs at the focal level were allotted to the Authorities. The wellbeing



**Deeksha et al.,**

administration gives essential, optional, and tertiary consideration. Network level mobile consideration is conveyed by means of a system of 343 wellbeing places. Optional and tertiary consideration is offered through 23 government emergency clinics and the University of the West Indies educating medical clinic. Numerous jobs at the focal level were allocated to the Authorities. The wellbeing administration gives essential, auxiliary, and tertiary consideration. Network level walking care is conveyed through a system of 343 wellbeing places. Optional and tertiary consideration is offered through 23 government emergency clinics and the University of the West Indies educating medical clinic [14].

**Licensing****Licensing of Premises**

The Pharmacy Council issues licenses to pharmaceutical producers, nearby pharmaceutical merchants (counting the administration's acquirement and dispersion organization – HCL), private revenue driven drug stores and approved venders of toxic substances. GMP inspection, conducted by Drug Inspectors employed to the PRAB, is a requirement for licensing of manufacturers and distributors, although the PRAB admitted that sometimes inspections are not conducted for renewal of licenses. The Pharmacy Council meets at least once per month to approve licenses based, in part, on the inspection reports submitted by the Council's Drug Inspectors. Premises licensed to store, distribute and sell pharmaceuticals must be under the control of a registered pharmacist. Importers are not licensed but all persons and establishments importing pharmaceuticals must apply for an import permit from the PRAB. Rules and criteria on pre-authorizing prerequisites are distributed and known by candidates. A portion of the criteria are characterized in the enactment and some are the consequence of details set by the Pharmacy Council every once in a while. Licenses are not issued for dispensing doctors [15].

**Import Permits**

Medicines cannot be imported into Jamaica without an import permit issued by the PRAB. The PRAB has decentralized the issuing of import permits with the Western Regional Authority also fulfilling that function on behalf of the PRAB. Unregistered medicines cannot be imported into the island except for limited amounts imported by HCL for emergency use in the public sector or in accordance with a special request from a physician for one-off emergency use by an individual patient. In such cases, a Certificate of Analysis for the product must be submitted as a requirement for issuing the import permit. Investigational products require import permits. Requirements for importation of drugs, including a flow chart outlining the process for application of an import permit, are published on the MOH's website. For 2006 and 2007, there was approximately 18,000 and 20,000 import permits issued, respectively. There were in excess of 18,000 permits issued during 2008. There were no revocations or withdrawal of permits for the past three years [16].

**Product Assessment and Registration**

There is an operational product assessment and registration system in Jamaica as stipulated under the Food and Drug Act 1964, the Food & Drug Regulations 1975 and other gazetted amendments. This applies for all medicines for human and veterinary use. Herbal medicines and medical devices and applications were recently included as items requiring registration. Donated pharmaceuticals must meet registration requirements. Enforcement of medicines registration started prior to 1975 although records only started to be maintained in that year. As at February 2009, there were 12,124 medicines on the register. It is not known how many of those products are actually marketed in Jamaica. The proportion of the registered products that are generic products could not be easily determined. Applications for registration are submitted using standard application forms that are available at the PRAB and online from the MOH's website. The same form is used for both new products and known products. For assessment purpose the list of requirements are [17].



**Deeksha et al.,**

## CONCLUSION

The LATAM district comes up short on an incorporated or reliable medication enrollment technique. Urgent contrasts exist in the territory between nations. Likewise, most nations require extra documentation that isn't a piece of CTD Modules 2–5 which may likewise be trying to get. An assortment of administrative bodies have gone into exchange understandings to help reduce a portion of those challenges and encourage exchange between Latam American nations. One of those understandings became effective between wellbeing experts in Argentina, Brazil, Colombia and Cuba. This understanding permits Good Manufacturing Practices (GMP) investigation reports for the part nations to be the premise of GMP authentications in any of the other part nations, permitting controllers to consume assets somewhere else. The administrative pharmaceutical area at LATAM is probably going to be affected by numerous different changes in the coming years. In spite of the fact that the world is as yet overwhelming, the administrative condition is becoming increasingly adaptable and offering global pharmaceutical organizations more prominent chances.

## ACKNOWLEDGEMENT

I acknowledge to Dr. Balamuralidhara V, who helped me in proof reading article, helped me in writing this review article with good scientific merit and language support. This work was carried out in collaboration between the three authors. The authors Deeksha K S, Dr Balamuralidhara V, who carried out the literature search, performed statistical analysis, carried out the work and wrote article. All together read and approved this final manuscript.

## CONFLICT OF INTEREST

There are no conflict of interest about the publication on this manuscript among all the authors and not currently being considered for publication by another journal.

## REFERENCES

1. Prevention and Treatment - What You Need to Know About Infectious Disease - NCBI Bookshelf [Internet]. [cited 2021 Nov 10]. Available from: <https://www.ncbi.nlm.nih.gov/books/NBK209704/>
2. Generic Drugs: Questions & Answers | FDA [Internet]. [cited 2021 Nov 10]. Available from: <https://www.fda.gov/drugs/questions-answers/generic-drugs-questions-answers>
3. Measuring medicine prices, availability, affordability and price components 2ND EDITION. 2008;
4. Pharma industry market value Latin America 2020 | Statista [Internet]. [cited 2021 Nov 10]. Available from: <https://www.statista.com/statistics/418021/revenue-from-pharmaceutical-industry-in-latin-america-by-major-country/>
5. Pharmaceutical industry in Brazil - Statistics & Facts | Statista [Internet]. [cited 2021 Nov 10]. Available from: <https://www.statista.com/topics/5107/pharmaceutical-industry-in-brazil/>
6. Latin America Pharma Market 9% Growth | Global Health Intelligence [Internet]. [cited 2021 Nov 10]. Available from: <https://globalhealthintelligence.com/ghi-analysis/latin-americas-pharmaceutical-market-growing-by-9-a-year/>
7. Economy of Argentina - Wikipedia [Internet]. [cited 2021 Nov 10]. Available from: [https://en.wikipedia.org/wiki/Economy\\_of\\_Argentina](https://en.wikipedia.org/wiki/Economy_of_Argentina)
8. Pharmaceutical industry in Mexico - Statistics & Facts | Statista [Internet]. [cited 2021 Nov 10]. Available from: <https://www.statista.com/topics/6074/pharmaceutical-industry-in-mexico/>
9. Pharmaceutical sector | Invest in Colombia [Internet]. [cited 2021 Nov 10]. Available from: <https://investincolombia.com.co/en/sectors/healthcare-services-and-life-sciences/pharmaceutical-sector>
10. Valverde JL. Latin American pharmaceutical overview. Pharm Policy Law. 2014;16(3–4):179–206.





Deeksha et al.,

11. Regulatory Frameworks for Digital Health in Latin American and the Caribbean: Electronic Health Records: Progresses and Next Steps | Publications [Internet]. [cited 2021 Nov 10]. Available from: <https://publications.iadb.org/publications/english/document/Regulatory-Frameworks-for-Digital-Health-in-Latin-American-and-the-Caribbean-Electronic-Health-Records-Progresses-and-Next-Steps.pdf>
12. Regulatory Consulting, Dominican Republic, 510k file Application [Internet]. [cited 2021 Nov 10]. Available from: <https://www.freyrsolutions.com/regulatory-services-in-dominican-republic>
13. Bannenberg W, Kerr V, Schürmann M, Sigonda M, Van Spengler V, Verhoeven P. CARICOM Regional Assessment of Drug Registration and Regulatory Systems-Volume II HERA / Final Report / Regional Assessment of Drug Registration and Regulatory Systems of CARICOM Member States and the Dominican Republic Final Report-Volume II: Countries and Regional Quality Control Laboratory Consultant Team. 2009;
14. Jamaica - Register Pharmaceutical Product [Internet]. [cited 2021 Nov 10]. Available from: [https://www.wikiprocedure.com/index.php/Jamaica\\_-\\_Register\\_Pharmaceutical\\_Product](https://www.wikiprocedure.com/index.php/Jamaica_-_Register_Pharmaceutical_Product)
15. Jamaica Trade Information Portal - View1 SearchProcedure [Internet]. [cited 2021 Nov 10]. Available from: <https://jamaicatradeportal.gov.jm/index.php?r=searchProcedure/view1&id=47>
16. VOLUME 5 SECTION 5 APPROVAL PROCESS FOR FOOD, DRUGS COSMETICS, MEDICAL DEVICES, PRECURSOR CHEMICALS AND NARCOTICS The Responsibility of the Ministry of Health 2-4 Kings Street Kingston.
17. Registration/Assessment Guidelines, Forms & Lists – Ministry of Health & Wellness, Jamaica [Internet]. [cited 2021 Nov 10]. Available from: <https://www.moh.gov.jm/divisions-agencies/divisions/standards-and-regulation-division/guidelines-forms-lists/>

**Table 2. Licensing of Premises**

Type of license issued	Fee in Dominican Pesos	Fee in USD
Opening of pharmacy	6000	168
Renewal of pharmacy license	2000	56
Moving of pharmacy	2000	56
Opening of manufacturing business	7000	197
Renewal of manufacturing license	6000	168

**Table 2. Registration Fees**

Type of license	Fee in Dominican Pesos	Fee in USD
New Product	7000	197
Natural Product	3000	168
Variations	3000	168
Renewal (every 5 years)	7000	197





Deeksha et al.,

Table 3. Product Assessment and Registration

a.	Summarized statement of 3 copies (not package insert) giving on: 1. In the formulation; all ingredients are present 2. Dose, dose schedule, route of administration; 3. Therapeutic / diagnostic claims; 4. Description of dosage form being registered; 5. Contraindication / precautions; 6. Side effects; 7. Toxic effects, and protocol for treating toxicity or where applicable, antidote.
b.	Details of the tests conducted to control the potency, purity, and stability.
c.	Summary of: 1. Clinical pharmacology: pharmacodynamics; pharmacokinetics; bioavailability. Bioequivalence studies including not less than twelve (12) subjects for all generic preparations. 2. Efficacy: controlled studies; uncontrolled studies; 3. Safety: adverse drug reactions in volunteers and where a new chemical moiety has been marketed for less than five (5) years, adverse drug reactions in patients.
d.	A Certificate of analysis (original, not photocopy) or certified report containing: 1. Assay report on a recent batch of the product analyzed; 2. The method of analysis used.
e.	Five (5) copies of a draft of every label bearing the address of the manufacturer proposed to be used in connection with the product, a batch/lot number and expiry date of the product.
f.	Five (5) samples of the new drug in the finished pharmaceutical form in which it is to be sold along with adequate amounts of appropriate chemical and / or biological reference standards of active ingredients necessary to perform analyses described in (c) two.
g.	A “Certificate of a Pharmaceutical Product” (original, not photocopy) bearing information as recommended by W.H.O. from the competent health authority in the country of manufacture (authenticated by the Jamaican Embassy or Jamaican Consulate in the country) certifying that the drug is approved for use and registered in that country and the conditions under which it may be sold in that country.
h.	A statement showing: 1. The countries in which the product is approved for sale other than the country in which it is manufactured.





## Role of MBI on Executive Functions: A Review

Poonam Garg<sup>1</sup>, Gargi Sharma<sup>2\*</sup> and Charu Dhankar<sup>2</sup>

<sup>1</sup>Research Scholar, Department of Psychology, Manipal University Jaipur, Jaipur, India.

<sup>2</sup>Assistant Professor, Department of Psychology, Manipal University Jaipur, Jaipur, India.

Received: 28 Nov 2021

Revised: 20 Dec 2021

Accepted: 13 Jan 2022

### \*Address for Correspondence

#### Gargi Sharma

Assistant Professor,

Department of Psychology,

Manipal University Jaipur,

Jaipur, India.

Email: gargi.sharma@jaipur.manipal.edu



This is an Open Access Journal / article distributed under the terms of the **Creative Commons Attribution License** (CC BY-NC-ND 3.0) which permits unrestricted use, distribution, and reproduction in any medium, provided the original work is properly cited. All rights reserved.

### ABSTRACT

Many new hurdles and challenges have been faced by adolescents these days. They have been overburdened with the pressure of performing well academically, in addition to maintaining complicated social relationship both online and offline. Such difficulties carry issues like dealing with stress, anxiety and everyday complications in student's life which in turn comes out in impulsive, aggressive, and agitated behavior. These frequent rising in such behavioral issues gives rise to the increasing juvenile activities. The literature suggests that the leading causes of such behavior can be the lack of cognitive flexibility, poor decisions making, emotional dysfunctional and deficient executive functioning. The main objective of this paper is to find the solution to such a problem. This paper will provide the prevention model for assessing an individual by stepping on the different aspects of mindfulness-based intervention. The paper is an attempt to help individuals in strengthening the executive functioning and to evaluate the impact of mindfulness-based intervention on executive functioning.

**Keywords:** Executive functioning, Mindfulness, Impulsive behavior.

## INTRODUCTION

Adolescence is a very crucial period in an individuals' life for sociopsychological development as they are more prone to mental health issues due to many physical, emotional, social changes and exposure. The impulsive and aggressive behaviour is visible on smaller issues which, later, becomes the leading cause of the criminal behaviour among adolescents. Executive functions are the intellectual strategies that enable us to plan, pay attention, consider instructions, and juggle more than one obligation correctly. These skills are associated with focus and corporation. Some individuals seem to usually have their lives in order, with the correct lists and an appropriate schedule. They are the ones with sturdy executive functioning capabilities. Some human beings have difficulty focusing, dealing with time, switching attention, and controlling their impulses. According to Umbach, Raine and Leonard (2017), executive functioning is effected if a person (aged 16 to 18) attempts any crime and gets custody, research shows that custody aggravates a known risk factor for crime. Adolescents' capacities of awareness, decision-making, and





**Gargi Sharma et al.,**

problem-solving, which are highly affected by cognitive skills, emotional, social, and physical situations also vary. As a result, it is theorized that the development of executive functions in adolescence may be modulated in an emotional or social context. In this stage of life there is a noticeable change in the grey and white matter of the cortex. Variation in brain structure in this age effect social awareness and expectations. Proper secretion of hormones improves the communication between the individual and the environment. Kessler et al., (2005), reported that teens are vulnerable for the inception of mental health issues, with over 50% of mental illness being visible before the age of 14.

As reported by riggs et al., 2006; bierman et al., 2008 the socioemotional and educational abilities of an adolescent enhance due to appropriate functioning of executive functioning. A vital aspect of executive functioning is to deal with situations causing hasty, impulsive, and imprudent actions or judgement. This is more relevant in adolescence period as executive functioning continues to develop in this phase (best and miller, 2010; taylor et al., 2015). study by burnett et al., 2013 shows that the transition from adolescence to adulthood encapsulates challenging responsibilities and self-regulatory demands, it requires high dependence on cognitive aspects. Diamond, 2013, elaborated on the importance in childhood and adolescence, thus it is impeccable to observe, test and intercede of problems in early life .Previous study showed that impaired executive function can be predisposing to criminal behavior in early age (Miura, Fuchigum, 2016).Ramirez, Marrero and Rodriguez, 2018 completed a study to see executive functioning in sex- offenders & they found the significant impairment. A previous study suggested that people who have poor coping mechanisms, interpersonal skill, unhealthy problem-solving skills, lack of cognitive flexibility, poor decisions making, emotional dysfunctional, and the other poor executive functioning are the leading factors for this such type of behavior.

For controlling adolescent's impulses & maladaptive behavior specialist use various type of psychotherapeutic intervention, like, cognitive behavior therapy, RATIONAL behavior therapy, dialectical behavior therapy etc. Mindfulness is also a psychotherapeutic intervention which was invented for the recurrent depressive disorder, rumination, worry or anxiety. Gradually it is also used to manage emotional disturbances, which is very effectual. There are various studies which showed a significant impact of mindfulness program on executive functioning in different age groups. Desai, (2015) reported youths face a lot of social, emotional pressure that affects negatively, as a result it develops several social and behavioral problem. According to Zinn (1994),mindfulness is defined in psychological terms as being characterized by paying total attention to the present moment with a non-judgmental awareness of the inner and outer experiences. Hence, mindfulness is an effective technique to overcome with social and behavioral problems.

An increasing frame of literature helps us to understand that Mindfulness Based Intervention (MBI) is impactful in selling fitness improvement in psychophysiological health. (Fjorback, Arendt, Ornbol, Fink, & Walach, 2011; Khoury, Sharma, Rush, & Fournier, 2015).It enhances the cognitive functioning in early childhood (Zelazo, A., Forston, J., Masten, A., and Carison, S., 2018). Several studies show improvement in self-compassion, worrying, through MBSR (Mallya, S., & Alexandra, J., 2015). Current evidence suggests that Mindfulness could significantly improve kids' executive functions, emotional regulation, strain, and pedagogical attainment (Hanceroglu,2015).Mindfulness based intervention was found effective in the adolescents with chronic disease in the clinical settings. It improved stress, depression, anxiety and the chronic pain in this group of age (Abujaradeh, Safadi, Sereika, Kahle & Cohen, 2018). Research shows that MBI supports individuals with and without disabilities with aspects of cognition such as stress and executive function. Mindfulness has been found beneficial in stress reduction (Bergen-Cico, Possemato, & Cheon, 2013), with increased attention and improvement in the self-regulation skills (Tang, 2007).Psychological researchers have established that mindfulness effects dual distress routes in cortex, modifying brain formation and action in areas connected with consciousness and affect regulation. They too found proof that homo sapiens administered on MBCT reacted comparatively fewer to their pessimism in stressful situations and were able to focus on current situation. A study reveals that the feasibility attitude towards the result of a five-week mindfulness meditation intervention on teenagers was identified with the learning impairment. Result showed as significant







Gargi Sharma et al.,

decrement in situational and trait-anxiety, improved sociability, and upgraded academic outcome (Beauchemin, Hutchins and Patterson, 2008).

### OBJECTIVE OF THE STUDY

To review the impact of Mindfulness based intervention on executive functioning in adolescents. Impact of Mindfulness Based intervention on Executive Function in adolescents The aim of the current research work was to review the effect of Mindfulness Based Intervention on executive functions including attention, memory, decision-making, planning, mental shifting, verbal fluency, and the other related executive functions. Several meaningful results are observed. We hypothesized that Mindfulness based intervention or brief intervention of mindfulness can improve executive functions. The review evaluated the existing evidence that mindfulness training improves executive functioning in youth (Chiesa, Calati, & Serretti, 2011). Studies showed that MBSR enhances ethical reasoning and judgements in adults. (Shapiro, S., Jazaieri, H., Goldin, P., 2012). The literature also suggest that brief mindfulness training used as a tool to improve visual-spatial processing, working memory and executive functioning, reduces fatigue, anxiety & increases mindfulness in students (Zeidan, Johnson, Diamond, David & Goolkasian; 2010).

Research supports the previous research shows that the Short-term mindfulness practice improved working memory capacity and other cognitive functions in adolescents (Quach, Mano & Alexander, 2016). It helps to improve coping mechanisms and promotes healthy problem-solving skills to deal with the daily life stress with depression or anxiety, maintain effective interpersonal skills, cognitive flexibility, and emotional functioning to maintain healthy relationship to the others (Dunning, Griffiths, Kuyken, Crane & Parker, 2019). A study reveals that the mindfulness improved executive functioning in adolescent with autism spectrum disorders (Turner, 2016). It also shows positive effects in female adolescents with the advancements in ADHD signs (Kiani, Hadlanfard & Mitchell, 2017). A study also supports that mindfulness have positive impact in treatment of teens with ADHD (Zylowska, 2008). Mindfulness training improved executive functioning in white-collar criminals. It enhanced their information processing, social cognition good decision making and emotional regulations (Umbach, Raine & Leonard, 2017). American-Spanish adolescents face up to stress related culture shock, differentiation & assimilation. These experiences create psychological problems like depression, anxiety, suicidal ideation. Result shows that after mindfulness practice they work effectively on these aspects of psychological problems and it also improves their executive functioning (Huang, Chen, Cheung, Lu, Rios & Wei, 2018).

There is a growing body of research suggested that mindfulness programme nurture executive function and effective in emotional control, self-monitoring, anxiety, and depression. (Lam, Seidan, 2019, Janz, Dawe & Wyllie, 2019). A study reviewed that children between the age of 9 to 12 years, experienced greatest improvements in behavioral regulation, meta-cognition and executive function due to the mindfulness--skills (Flook, 2010).

### CONCLUSION

It is worth mentioning that mindfulness-based intervention has strong impact on executive functions in adolescents. It enhances the attention, working memory capacity and improves decision making, visual-spatial processing & planning which gets affected in this age. Mindfulness training is even effective in adolescents with Autism spectrum disorder & ADHD symptoms, which improves symptoms of these disorders. The limitation of this study is the limited numbers of studies, due to which generalization is difficult. Furthermore, other contributing factors like socio- environmental, personality traits, upbringing of an adolescent should be explored. Besides, a standard neuropsychological battery for cerebral function assessment could be used to check the cognitive deficits accurately.





**Gargi Sharma et al**

## REFERENCES

1. Best, J. R., Miller, P. H., & Jones, L. L. (2009). Executive functions after age 5: Changes and correlates. *Developmental review, 29*(3), 180-200.
2. Bierman, K.L., Domitrovich, C.E., Nix, R.L., Gest, S.D., Welsh, M. T., Greenberg, C.B., et al. (2008). Promoting academic and social-emotional school readiness: The head start REDI program. *Child Dev, 79*(6):1802-17.
3. Chiesa, A., Calati, R., & Serretti, A. (2011). Does mindfulness training improve cognitive abilities? A systematic review of neuropsychological findings. *Clinical psychology review, 31*(3), 449-464.
4. Desai, P. (2015). *Exploring the impact of mindfulness on adolescents: A mixed methods approach* (Doctoral dissertation, Loyola University Chicago).
5. Hanceroglu, L. (2017). Investigating the Effects of Mindfulness on Children's Executive Function, Emotional Regulation, Stress, and Academic Performance Compared to a Control Condition.
6. Janz, P., Dawe, S., & Wyllie, M. (2019). Mindfulness-based program embedded within the existing curriculum improves executive functioning and behavior in young children: A waitlist-controlled trial. *Frontiers in Psychology, 10*, 2052.
7. Kessler, R.C., Berglund, P., Demler, O., Jin, R., Merikangas, K.R., & Walters, E.E. (2005). Lifetime prevalence and age-of-onset distributions of DSM-IV disorders in the National Comorbidity Survey Replication. *Arch Gen Psychiatry, 62*, (6), 593–602.
8. Lam, K., & Seiden, D. (2020). Effects of a brief mindfulness curriculum on self-reported executive functioning and emotion regulation in Hongkong adolescents. *Mindfulness, 11*(3), 627-642.
9. Leonard, N. R., Jha, A. P., Casarjian, B., Goolsarran, M., Garcia, C., Cleland, C. M., & Massey, Z. (2013). Mindfulness training improves attentional task performance in incarcerated youth: A group randomized controlled intervention trial. *Frontiers in psychology, 4*, 792.
10. Mallya, S., & Fiocco, A. J. (2016). Effects of mindfulness training on cognition and well-being in healthy older adults. *Mindfulness, 7*(2), 453-465.
11. Riggs, N.R., Laudan, J., Razza, R., Janean, D.B., & Ulrich, M. (2006). Executive function and the promotion of social-competence. *Journal of Applied Developmental Psychology, 27*. 300-309.
12. Ritter, A., & Alvarez, I. (2020). Mindfulness and executive functions: making the case for elementary school practice. *European journal of investigation in health, psychology and education, 10*(1), 544-553.
13. Taylor, S. J., Barker, L. A., Heavey, L., & McHale, S. (2015). The longitudinal development of social and executive functions in late adolescence and early adulthood. *Frontiers in behavioral neuroscience, 9*, 252.
14. Umbach, R., Raine, A., & Leonard, N. (2017). Cognitive Decline as a Result of Incarceration and the Effects of a CBT/Mindfulness Training Intervention: A Cluster-Randomized Controlled Trial. *Criminal Justice and Behavior, 45*(01), 009385481773634.
15. Zeidan, F., Johnson, S. K., Diamond, B. J., David, Z., & Goolkasian, P. (2010). Mindfulness meditation improves cognition: Evidence of brief mental training. *Consciousness and cognition, 19*(2), 597-605.
16. Zelazo, P. D., Forston, J. L., Masten, A. S., & Carlson, S. M. (2018). Mindfulness plus reflection training: Effects on executive function in early childhood. *Frontiers in psychology, 9*, 208.





## Initiation of Apoptosis through Activation of Caspase and DNA Fragmentation by Organo Synthesized Thiophene Derivative using Diazane and *Averrhoa bilimbi*

Ancy Devadas<sup>1\*</sup>, N. Shiny<sup>1\*</sup> and S. Jasmin Sugantha Malar<sup>2</sup>

<sup>1</sup>Research Scholar, Women's Christian College, Affiliated to Manonmaniam Sundaranar University, Abishekapatti, Thirunelveli – 627012, Tamil Nadu, India

<sup>2</sup>Assistant Professor, Women's Christian College, Nagercoil, Tamil Nadu, India.

Received: 08 Dec 2021

Revised: 30 Dec 2021

Accepted: 13 Jan 2022

### \*Address for Correspondence

#### Ancy Devadas

Research Scholar,

Women's Christian College,

Affiliated to Manonmaniam Sundaranar University,

Abishekapatti, Thirunelveli – 627012,

Tamil Nadu, India

Email: ancydevadas@gmail.com



This is an Open Access Journal / article distributed under the terms of the **Creative Commons Attribution License** (CC BY-NC-ND 3.0) which permits unrestricted use, distribution, and reproduction in any medium, provided the original work is properly cited. All rights reserved.

### ABSTRACT

Sulphur is the key atom existing in the thiophene derivative. All are familiar of heterocyclic compounds and their application in different sectors. The hetero atoms such as O, N and S have lot of importance in biological industries. Nowadays diseases increases in an alarming rate and all the chemist are busy innovating new drug in order to kill the pathogenic bacteria and virus. Cancer is also a deadly disease, which has been very common in the society. So in order to overcome these diseases we have to originate new drugs. In the present analysis, ethyl-2 amino-4,5,6,7-tetrahydro benzothiophene-3-carboxyhydrazide (B) was synthesized using hydrazine hydrate and bilimbi extract was added to enhance the biological activity. The compound was under study for the determination of apoptosis by acridine orange (ao) and ethidium bromide (etbr) double staining and caspase 7 protein activation. The DNA fragmentation assay was also studied. The logical and new informational evidences, presented in the current study have rendered thiophene derivative with the effect of *Averrhoa* have wide choice of applications in ever challenging chemotherapy of various ailments and infections.

**Keywords:** Thiophene, *Averrhoabilimbi*, Synthesis, caspase 7, Apoptosis, ethidium bromide, DNA fragmentation and acridine orange.





Ancy Devadas et al.,

## INTRODUCTION

Add some extra sunshine and warmth to your diet by eating more citrus fruits. Fruits are the natural gift given by nature. Health authorities know that fruit is highly nutritious, delightful and suitable addition to any diet. Citrons have a superficial effect on human health by both direct and indirect means and also hold gigantic medicinal properties. Early medication revolved around the therapy of nutrients for certain illnesses. The proposal of remedy fragments doubtfully offers some of the extreme confidences for achievement in current and upcoming era. Heterocyclic compounds are extensively dispersed in environment and are vital for life. Chemists has exposed that the ion compounds has a wide range of pharmacological activities anti-bacterial, anti-allergic, antifungal, cytotoxic, anti-inflammatory, analgesic, anti-diabetics, anticancer activities etc. *Averrhoa bilimbi* is the fruit of the tree which covers huge of organic activity. The fruit skin colour ranges from greenish yellow to yellow and is crunchy and sour in taste. It may or may not be full with two to five tiny eatable seeds. It has great quantities of antioxidants like polyphenolic compounds, quercetin, gallic acid and epicatechin. The citric acid present in the fruit gives Vitamin C content. By keeping all the biological activity of fruit and knowing the importance of heterocyclic atom in medicinal industry, the theion carbohydrazide was prepared using hydrazine hydrate and *Averrhoa bilimbi*.

### Experimental method

#### Preparation of *Averrhoa* fruit extract (P)

Citrus fruit extracts were used as a catalyst to improve the effectiveness of synthesized compounds. *Averrhoa bilimbi* (bilimbi) was extracted using ethanolic solvent by separation method. About 50 g of each grinded fruit was taken in a 500 mL round bottom flask with 250 mL ethanol. After extraction, the fruit extract was filtered and concentrated using a distillation process. The extract was taken for further conjugation approaches with synthesized derivatives.

#### Synthesis of ethyl-2 amino-4,5,6,7-tetrahydro benzothiophene-3-carboxyhydrazide using bilimbi fruit ethanolic extracts (B1)

The synthesized ethyl-2 amino-4,5,6,7-tetrahydrobenzothiophene-3-carboxylate (S-I) derivative was mixed with 5 mL of fruit extract in 20 mL ethanol and stirred magnetically for 30 minutes. Then hydrazine hydrate was added to the reaction mixture and heated under reflux on the water bath for 4 hours. After that, each preparative was poured onto ice and colorless crystalline solids were separated to re-crystallize from ethanol. The entire above synthesized chemical and plants based derivatives were processed for further spectral characterization studies.

## RESULT AND DISCUSSION

### DNA fragmentation assay of compound B1

HOS (Osteoblast) cells were preserved with compound B2 and a control in order to know how the oncogenic cells were tainted. The isolated DNA was exposed to gel electrophoresis in 1.5% Agarose gel (Lonza) pertained with ethidium bromide. The gel was observed and shot under a standard gel documentation system (E gel imager, Invitrogen USA). DNA fragmentation assay was analyzed to check the cleavage of DNA. Human Osteosarcoma cells were treated with compound B1 at LD 50 concentration (20 µg/ml) and control cells are not treated with B1. Control cells shows band width value 2000bps and human osteosarcoma cell treated with compound B1 shows band width value 1500 bps. This shows that degradation of chromosomal DNA of HOS cell line has been cleaved. As a result, Apoptotic nuclease activity was studied in the cells treated with sample B1(Lane 2) this indicate that the cells undergo apoptosis. Control cells without any action did not show disintegration.

### Caspase-7 assay

Caspase 7 assay is used to regulate the action of Caspase 7 protein which has a vital role in initiation of apoptosis. The concentration of protein in the caspase-7 showed high once treated with sample (1.038536). The caspase 7 level is found very high in the Human osteosarcoma cells treated with sample B1 (0.635782 Units/mg protein) but in the control untreated cell caspase 7 activity is found very low (0.426353Units/mg protein) this is because of the lack of



**Ancy Devadas et al.,**

caspase 7 protein in the control. From the above study it is clear that the sample is active against the carcinogenic cells and the sample does not affect the normal cells. With the sample the protein concentration has been higher in the HOS cell and the sample has been proved that it contains many pharmacological screening effects.

#### **Determination of apoptosis by acridine orange (ao) and ethidium bromide (etbr) double staining**

Apoptosis was confirmed by observing the nuclear morphology by AO/EB staining. Apoptosis has a dynamic part in abolishing cells which are selectively avoidable or that extant a danger to the integrity of an organism, thereby controlling the growth and/or spread of malignancy. The most important apoptotic paths are intrinsic and extrinsic. The intrinsic (or mitochondrial) path can be persuaded through intracellular stresses such as DNA damage or oxidative stress leading to the release of mitochondrial cytochrome c creating the apoptosome complex. DNA-binding dyes Acridine Orange (AO) and Ethidium Bromide (EtBr) (Sigma, USA) were used for the morphological recognition of apoptotic and necrotic cells. AO is taken up by both viable and non-viable cells and produces green fluorescence if interpolated into double stranded nucleic acid (DNA). EtBr is occupied up only by non-viable cells and radiates red fluorescence by intercalation into DNA. The stained cells were washed twice with 1X PBS and observed by a fluorescence microscope in blue filter of fluorescent microscope (Olympus CKX41 with Optika Pro5 camera)

In the current study, the cells were separated into four groups as follows: living cells (normal green nucleus) (1), early apoptotic (bright green nucleus with compressed or fragmented chromatin) (2), late apoptotic (orange-stained nuclei with chromatin condensation or fragmentation) (3) and necrotic cells (uniformly orange-stained cell nuclei) (4). The AO and EtBr staining famed the dead cells as an apoptotic bodies and necrotic bodies stained in orange nuclei showed in figure 3. In the figure c the arrows specified the apoptotic cells which are in orange colour and the green cells are the normal living cell. In the figure d the arrow specifies the occurrence of necrotic cells, while the live cells persist in green fluorescent colour. The HOS cells revealed the apoptosis programme after action with compound and leads to the degradation of chromatin and nucleus fragmentation. From the above studies, it is verified that the compound is extremely active against the HOS cell line and the sample did not kill the normal living cells.

## **CONCLUSION**

In conclusion, an appropriate method for the synthesis of ethyl-2 amino-4,5,6,7-tetrahydro benzothiophene-3-carboxyhydrazide using *Averrhoa bilimbi* fruit ethanolic extracts (B1) in good yield and assessed their DNA fragmentation assay, caspase 7 assay and apoptosis assay was studied. The compound was subjected to DNA fragmentation assay, it was proved that the DNA of HOS cell line treated with the sample has cleaved into smaller fragments. This shows that compound B1 has the ability to degrade the carcinogenic cells. Caspase study with the compound was done and the protein concentration has been noticed higher in the HOS cell treated with compound B1. It is verified that the compound is extremely active against the HOS cell line and the sample did not kill the normal living cells. From the current examination, so far, we were able to prove that the ions are expressively important class of heterocyclic compounds and they have an extensive range of tenders in ever challenging chemotherapy of numerous ailments, infections.

## **REFERENCES**

1. Isloor. A. M, Kalluraya .B, Sridhar Pai. K, 2009, synthesis characterization and biological activities of some new benzo [b] thiophene derivatives. European journal of medicinal chemistry, vol. 45, no. 2, pp. 825 – 830.
2. SihamLahasasni, Dunya A. M. Al – Hemyari, Hazem A. Ghabbour&Asma. A. Alothman, 2018, synthesis, characterization and antibacterial and anti-inflammatory activities of new pyrimidine and thiophene derivatives, journal of chemistry, vol. 10, pp. 1055.



**Ancy Devadas et al.,**

3. Archana, Shelly Pathania, 2020, Thiophene based derivatives as anticancer agents: An overview on decade's work, Bio-organic chemistry, vol. 10, pp. 1055.
4. Dos Santos, FlavianaAlves; Pereira, MichellyCristiny, 2018, Anticancer properties of thiophene derivatives in breast cancer MCF-7 cells, Anti-Cancer Drugs, Vol. 29, pp. 157-166(10)
5. Dina I.A. Othman, Khalid B. Selim, Magda A.-A.El-Sayed, 2019, Design, Synthesis and Anticancer Evaluation of New Substituted Thiophene-Quinoline Derivatives, Bioorganic & Medicinal Chemistry, Vol. 27, Issue 19.
6. Matteo Mori, Giovanni Stelitano, Laurent R. Chiarelli, 2021, Synthesis, Characterization, and Biological Evaluation of New Derivatives Targeting Mtb1 as Anti tubercular Agents, journal of Pharmaceuticals, Vol 14, Issue 2, pp. 10
7. Mastoura M. Edrees, Sraa Abu- Melha, Amirah M. Saad, 2018, Eco-Friendly Synthesis, Characterization and Biological Evaluation of Some Novel Pyrazolines Containing Thiazole Moiety as Potential Anticancer and Antimicrobial Agents, Molecules, Vol 23, Issue 11.
8. Alisha Valsan, Regi Raphael K, 2016, Pharmacognostic profile of Avertroabilimbi Linn. Leaves. Phytosynthesis of Iron Nanoparticle from Avertroabilimbi Lin, South Indian Journal Of Biological Sciences; vol. 2(1); pp.75-80.
9. I. R. Rosli, H. I. Zulhaimi, S. K. M. Ibrahim, 2018, Development of fruit jam from Avertroabilimbi L. journal of food processing and preservation, Materials Science and Engineering, Vol. 318, pp. 318 012012
10. NurAmilahAnuar, RabetaMohdSalleh, 2020, Antibacterial Activity of Various Extracts of Avertroabilimbi against Multidrug Resistant Bacteria, journal of biology and biology education, Vol 12, No 2
11. Muhammad EvyPrastiyanto, FandhiAdiWardoyo, Wildiani Wilson, Sri Darmawati, 2010, Journal of Medical Microbiology & Diagnosis Antimicrobial Properties of Avertroabilimbi Extracts at Different Maturity Stages, Volume 43, Issue 4.
12. Sitanggang AB, Alexander R, Budijanto S, 2020, The utilization of bilimbi (Avertroabilimbi) and lime (Citrus aurantifolia) juices as natural acid coagulants for tofu production. Journal of Food Science and Technology, vol. 57(12): pp.4660-4670.
13. Alhassan Muhammad Alhassan and QamarUddin Ahmed, 2016, Avertroabilimbi Linn: A review of its ethnomedicinal uses, phytochemistry and pharmacology, J Pharm Bioallied Sci. vol. 8(4): pp. 265–271.
14. Sri Utami, Susi Endrini, Said Nafik, IntanMeilaTria Lestari, 2019, In vitro Antioxidant and Anti-obesity Activities of Freeze-dried Canarium sp., Avertroabilimbi L. and Malus domestica, Vol 11, No 3.
15. Katrina A. Madarangsabela 2020 Go natural: development of cleaner and disinfectant from cucumber tree (avertroabilimbi), Journal of Critical Reviews, Vol 7, Issue 11, pp. 2394-5125.
16. Nakyinsige, K., Abdul Rahman, N.S., Sazili, A.Q, 2016, Effect of belimbingbuluh (Avertroabilimbi) juice extract on oxidative stability and microbiological quality of spent chicken meat, International Food Research Journal, vol. 23(6), pp. 2675-2680.
17. Albi Francis, YogendraNayak, 2017, A multifaceted peer reviewed journal in the field of Pharmacy Modulation of Doxorubicin-Induced Cardio toxicity by Avertroabilimbi extract, J Young Pharm, vol. 9(1), pp. 69-77.
18. S. Murugavel, C. Ravikumar, G.Jaabil, PonnuswamyAlagusundaram, 2019, Synthesis, computational quantum chemical study, in silico ADMET and molecular docking analysis, in vitro biological evaluation of a novel sulfur heterocyclic thiophene derivative containing 1,2,3-triazole and pyridine moieties as a potential human topoisomerase II $\alpha$  inhibiting anticancer agent, Computational Biology and Chemistry, Vol. 79, pp.73-82
19. Mishra, Raghav; Kumar, Nitin; Mishra, Isha; Sachan, Neetu, 2020, A Review on Anticancer Activities of Thiophene and Its Analog, mini reviews in medicinal chemistry, vol. 20, pp. 1944-1965
20. Menghui Zhao, YaxinCui, Lang Zhao, 2019, Thiophene Derivatives as New Anticancer Agents and Their Therapeutic Delivery Using Folate Receptor-Targeting Nanocarriers, ACS Omega, vol. 4, pp. 8874–8880
21. MetinKonus, DoğanÇetin, Can Yılmaz, SevkiArslan, DogukanMutlu, 2020, Biological Chemistry & Chemical Biology Synthesis, Biological Evaluation and Molecular Docking of Novel Thiophene-Based Indole Derivatives as Potential Antibacterial, GST Inhibitor and Apoptotic Anticancer Agents Chemistry Select, vol. 5, pp.5809 – 5814
22. El-Metwally, Souad A., Khalil, Ali K., 2020, 5-Nitro-Thiophene-Thiosemicarbazone Derivatives Present Antitumor Activity Mediated by Apoptosis and DNA Intercalation, Current Topics in Medicinal Chemistry, Vol. 19, Number 13, pp. 1075-1091.



**Ancy Devadas et al.,**

23. ThaisLisboa, Daiana Silva, Sâmia Duarte, 2020, Toxicity and Antitumor Activity of a Thiophene–Acridine Hybrid. *Molecules*, vol. 25(1), pp.64;
24. BetülKayaÇavuşoğlu, LeylaYurttaş, ZerrinCantürk, 2018, The synthesis, antifungal and apoptotic effects of triazole-oxadiazoles against *Candida* species. *European Journal of Medicinal Chemistry*, Vol. 144, pp. 255-261.
25. QiSun, NingDing, ChaofengZhao, 2021, Positional isomerism for strengthening intermolecular interactions: Toward monocyclic nitraminooxadiazoles with enhanced densities and energies, *Chemical Engineering Journal*, Vol. 427, pp. 13091.
26. Sobhi M. Gomha, Zeinab A. Muhammad, Ahmed A. M. El-Reedy, 2018, Intramolecular Ring Transformation of Bis-oxadiazoles to Bis-thiadiazoles and Investigation of Their Anticancer Activities, *Journal of Heterocyclic Chemistry*, Vol. 55, Issue10, Pages 2360-2367
27. BanfengRuan, YuezhouZhang, 2020, Synthesis and structure-activity relationship study of pyrrolidine-oxadiazoles as anthelmintics against *Haemonchus contortus*, *European Journal of Medicinal Chemistry*, Vol. 190, pp. 112100
28. MalleswaraRaoKuram, Woo Gyum Kim, KyungjaeMyung, 2016, Copper-Catalyzed Direct Synthesis of 1,2,4-Oxadiazoles from Amides and Organic Nitriles by Oxidative N–O Bond Formation *European Journal of Organic Chemistry*, Vol. 2016, Issue3, Pp. 438-442
29. AmbraCampofelice, Laura Lentini,, Aldo Di Leonardo, 2019, Strategies against Nonsense: Oxadiazoles as Translational Readthrough-Inducing Drugs (TRIDs), *Int. J. Mol. Sci.* vol. 20(13), pp. 3329;
30. M.MadhuSekharaU.NagarjunaaV.Padmavathi, 2018, Synthesis and antimicrobial activity of pyrimidinyl 1,3,4-oxadiazoles, 1,3,4-thiadiazoles and 1,2,4-triazoles, *European Journal of Medicinal Chemistry*, Vol. 145, Pp. 1-10
31. B. Srinivas, JettiboinaSuryachandram, Y. Katyayani Devi, KoyaPrabhakaraRao, 2017, Synthesis and Antibacterial Activity Studies of 8,9-Dihydro [7h] Benzo 1,2,4-Oxadiazoles and its Coumarin Derivatives, *Journal of Heterocyclic Chemistry*, Vol. 54, Issue.6, Pp. 3730-3734
32. Qing-Qing Tao, Li-Wei Liu, Pei-Yi Wang, 2019, Synthesis and In Vitro and In Vivo Biological Activity Evaluation and Quantitative Proteome Profiling of Oxadiazoles Bearing Flexible Heterocyclic Patterns, *J. Agric. Food Chem.* Vol. 67, pp. 7626–7639.
33. Weiwei Li, Jing He, Prof. Ping Liu, Jie Zhang, 2019, Synthesis of 4-Aryl-1,2,3-Thiadiazoles via NH4I-Catalyzed Cyclization of N-Tosylhydrazones with Sulfur, *Chemistry Select*, Volume4, Issue35, Pp. 10587-10590.
34. Sobhi M. Gomha, Zeinab A. Muhammad, Ahmed A. M. El-Reedy, 2018, Intramolecular Ring Transformation of Bis-oxadiazoles to Bis-thiadiazoles and Investigation of Their Anticancer Activities, *Journal of Heterocyclic Chemistry*, Vol. 55, Issue10, Pp. 2360-2367.
35. Sobhi M. Gomha, Zeinab A. Muhammad, Hatem M. Gaber, 2017, Synthesis of Some Novel Heterocycles Bearing Thiadiazoles as Potent Anti-inflammatory and Analgesic Agents, *Journal of Heterocyclic Chemistry*, Vol. 54, Issue5, Pp. 2708-2716.
36. Sobhi M. Gomha, Marwa S. El\_Gendy, 2018, Utility of Bis-Hydrzonoyl Chlorides as Precursors for Synthesis of New Functionalized Bis-Thiadiazoles as Potent Antimicrobial Agents, *Journal of Heterocyclic Chemistry*, Vol. 55, Issue4, Pp. 844-851.
37. Sobhi M. Gomha, Hassan M. Abdel-aziz, 2019, Efficient Synthesis of Some New 1,3,4-Thiadiazoles and 1,2,4-Triazoles Linked to Pyrazolylcoumarin Ring System as Potent 5 $\alpha$ -Reductase Inhibitors, *Journal of Heterocyclic Chemistry*, Vol. 56, Issue 4, Pp.1275-1282.
38. Sobhi M. Gomha, Mohamed G. Badrey, Mastoura M. Edrees, 2016, Heterocyclisation of 2,5-diacetyl-3,4-disubstituted-thieno[2,3-b]Thiophene Bis-Thiosemicarbazones Leading to Bis-Thiazoles and Bis-1,3,4-thiadiazoles as Anti-breast Cancer Agents, *Journal of Heterocyclic Chemistry*, Vol 40, Issue 2.
39. Ratnamala SB, 2016 Synthesis, 'Characterization and Antioxidant Activity of Carvacrol Containing Novel Thiadiazole and Oxadiazole Mod ChemAppl 4: 193.
40. KamrulIslam, 2014Antimicrobial Activity of Zingiberofficianale extracts against pathogenic bacteria
41. Raghav Mishra, 2011 'Synthesis, properties and biological activity of thiophene': A review *Der PharmaChemica*, 2011, 3 (4):38-54
42. T. Shivaraj Gouda, 2009, Synthesis, Characterization and Biological Activity of Some Thiophene Substituted Biheterocycles Containing Oxadiazoles, *Asian Journal of Chemistry* Vol. 21, No. 9 ,PP 7155-7162



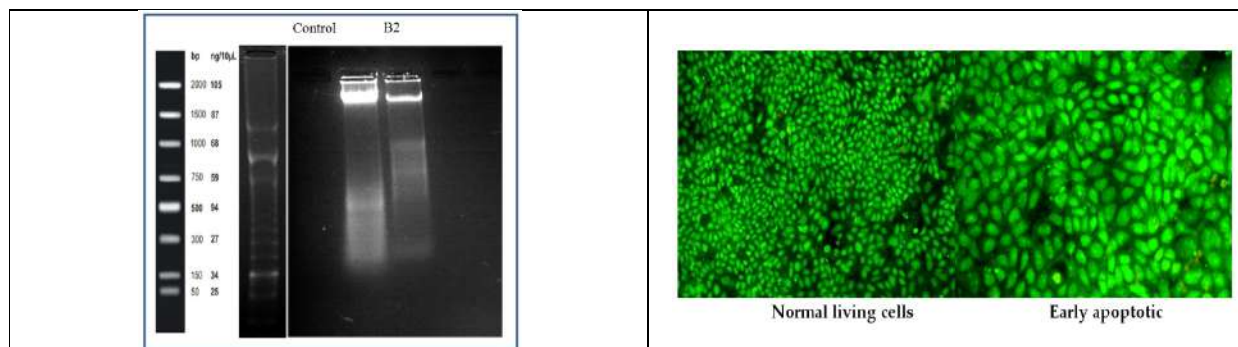


**Ancy Devadas et al.,**

43. Hamdan II, Afifi FU. 2004, Journal of Ethnopharmacology; 93: 117-121  
 44. Heidari R, Zareae S, Heidarizadeh M. Pakistan Journal of Nutrition 2005; 4 (2): 101-105.  
 45. R. T. Dewi, Y. M. Iskandar, M. Hanafi et al., Inhibitory effect of Koji Aspergillus terreus on  $\alpha$ -glucosidase activity and postprandial hyperglycemia, Pakistan Journal of Biological Sciences, vol. 10, no. 18, pp. 3131–3135, 2007.  
 46. R K Renatami, A Noerdin, B Irawan, and A Soufyan, 2018, Journal of Physics: Conference Series Effects of Differing Concentrations of Bilimbi (Averrhoa bilimbi L.) Extract Gel on Enamel Surface Roughness, Journal of Physics: Conference Series, Volume 1073, Issue 3.

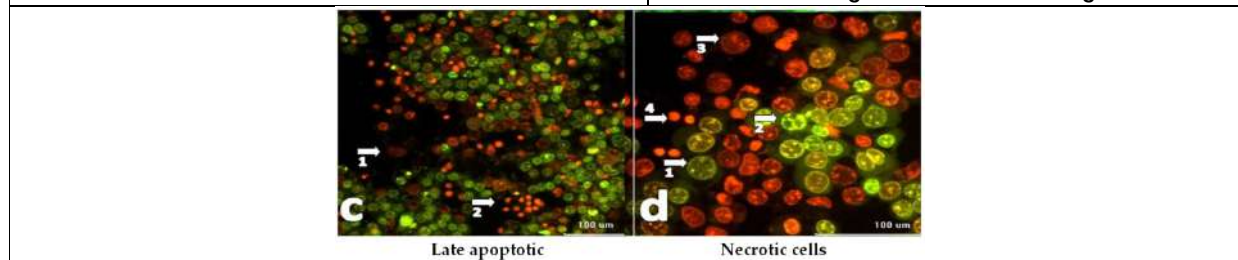
**Table1 : protein concentration and absorbance of compound B1**

Sample code	Absorbance at 415nm	Protein concentration	Activity Units/mg protein
Control	0.5237	1.026925	0.426353
B1	0.7053	1.038536	0.635782



**Figure 1: DNA Fragmentation of HOS cell line**

**Figure 2: Determination of apoptosis of HOS cells using AO and EtBr staining**



**Figure 3: c (Arrow indicates the dead cells) and d (Arrow indicates the presence of necrotic bodies)**







## Post-Partum Depression: A Review

Perna Sharma<sup>1\*</sup>, Aiman Mairaj<sup>2</sup> and Sreekiran.CV<sup>2</sup>

<sup>1</sup>Research Officer, Hindustan Latex Family Planning Promotion Trust, Noida, Uttar Pradesh, India.

<sup>2</sup>Research Scholar, Delhi Pharmaceutical Sciences & Research University, New Delhi, India.

Received: 24 Dec 2021

Revised: 04 Jan 2022

Accepted: 18 Jan 2022

### \*Address for Correspondence

**Perna Sharma**

Research Officer,

Hindustan Latex Family Planning Promotion Trust,

Noida, Uttar Pradesh, India.



This is an Open Access Journal / article distributed under the terms of the **Creative Commons Attribution License** [CC BY-NC-ND 3.0] which permits unrestricted use, distribution, and reproduction in any medium, provided the original work is properly cited. All rights reserved.

### ABSTRACT

Mental illness is a significant public health issue that accounts for 13% of the worldwide burden of disease, affecting both men and women. Researchers indicate women experience mental problems more than men in life due to their reproductive nature, specifically during puberty and reproduction time. Postpartum depression [PPD] is one such disorder that has grown in prominence as a considerable public health concern, affecting roughly 13% of women. The objective of this article is to identify and review various biological, psychosocial, and psychological risk elements along with screening and intervention measures associated with PPD. The strongest forecaster of PPD condemns psychological involvement during/before pregnancy, poor marital relationship, low social support, and stressful life incidents. Treatment choice incorporates pharmacological interventions, psychotherapy & psychosocial support. The present study concludes that non pharmacologic interventions need to be evaluated more for use in postpartum women experiencing episodes of depressive symptomatic for safe use during the lactating period.

**Keywords:** Post-Natal Depression, Puerperal depression, risk factors, prenatal anxiety, Intervention

### INTRODUCTION

Mental illness is one of the most serious public health issues, accounting for 13% of the worldwide disease burden and affecting both men and women. According to studies, women have more mental health issues than men throughout their lives as a outcome of their reproductive nature, particularly during puberty and reproduction [1]. Women's transition into motherhood entails considerable anatomical, behavioural, physiological, and psychological changes, which increases the risk of mental illness [2]. Postpartum depression is defined as an irritable, profoundly sad mood, loss of enjoyment, decreased energy, and activity that begins within four weeks or as late as 30 weeks after the neonate is delivered. The main predisposing variables that can contribute to postpartum depression in women include childcare stress, pregnancy anxiety, and stressful life events. Postpartum depression predisposes with history of depression and chronic reoccurring depression [3]. Current pieces of evidence have shown that





Prerna Sharma *et al.*,

mothers who are depressed after giving birth to the neonate are not able to breastfeed their babies. They are not able to provide proper care to their children influencing the mother-infant relationship and also adversely affect child maturation that may put children at higher risk of being underweight, stunted, and grater cognitive, behavioral, and interpersonal issues as the contrast with children of the non-depressed mother. PPDing is found to be associated more with adverse outcomes up to 10 years of the age of children [4]. In severe cases of depression, this can lead to emotions of pessimism, fright of hurt the newborn [36%], a weak companion to the infant [34%], and suicide, which is a factor in 20% of maternal mortality after giving birth to the neonate [5]. Because mental health has an impact on women's empowerment and increases mother and child mortality, one of the Sustainable Development Goals is to reduce premature mortality from non communicable diseases by improving mental health and well-being through prevention, treatment, and promotion. As a result, PPD is a critical issue to address, particularly in the context of a Low- and Middle-Income Country [LAMIC] like India. PPD is devitalizing mental diseases that affects around 13% of women in their first year after childbirth and is rapidly becoming a considerable public health perturbing [6]. The percentage has been approximate to be between 100 and 150 per 1000 births. As a result, it is critical to assess risk factors, screening, and therapies in order to aid in the control of depression in women and therefore reduce the burden of mental disease. The goal of this review is to discover and review numerous biological, psychosocial, and psychiatric risk elements for PPD, as well as screening and intervention approaches.

### Burden of Postpartum Depression

Extreme depression can conduct to suicide, and 850,000 people die each year as a result of it [7]. According to this, depression will be the second prime source of disability by 2025, and by 2030, it may be the leading source of illness burden. According to recent data, the prevalence of puerperal depression is greater in low- and lower-middle-income nations [8]. Although LAMICs make up more than 80% of the world's population, they only have 20% of the world's mental health resources. The prevalence is roughly 18.6%, according to a comprehensive review of 47 studies from 18 countries.

## METHODS

The present paper has cumulated existing online legal database published data and researches on post-partum depression globally for malpractice cases and examined based on factors like cause of malpractice, complications, and case outcomes from Pubmed, Google Scholar, Science Direct in the time ranges between 2000 and 2019. A total of 55 articles were reviewed in this narrative review, with 31 focusing on interventions, 9 on screening and diagnosis, 6 on risk factors, 5 on prevalence, and 4 on the load of postpartum depression. Each study's major findings and relevant statistical information were documented and differentiated based on scientific substance in their respective subsets, which were then discussed in subsections. At the outset of this review article, a general overview of PPD along with its burden is given. Important studies on post-partum depression have been examined in the following section. Then there's a rundown of the various biological, psychological, and psychological risk elements linked to PPD. More screening tools and intervention strategies are being investigated. The article concludes with recommendations for future practise and study.

### Risk Factors

PPD risk factors are classified as biological, psychosocial, and psychological risk factors, as well as previous history of psychiatric complaint, significant life events, and a lack of social support. The following is a brief summary of these factors:

#### Biological Risk Factors

The biological variants of risk factors range from the Endocrine system, Immune system & genetic factors which altogether/individually lead to the incurrence of puerperal depression [9]. According to studies, a lack of seafood consumption during pregnancy might lead to postpartum depression, and hence can be considered a biological factor deficiency [10]. According to etiological models, reproductive and stress hormones spike after birth and then





**Prerna Sharma et al.,**

drop sharply afterward, resulting in theorized triggering system deregulation and depressive symptoms. Physical elements that contribute to PPD include -stressors and interpersonal relationships, which include chronic strain, relationship quality, and partner support [3]. A study was carried out to determine the extent and forecast the levels of grief connected with childbirth, in addition of the risk of parturient depression [11]. The author used Questionnaires to analyse 211 women before and after 30 weeks of pregnancy, as well as after a delivery of 2-3 months, employing socioeconomic class and marital status components. Predicting episodes of sorrow or anxiety throughout pregnancy is an early and substantial predictor of puerperal depression, according to the findings of the study. Furthermore, higher levels of anxiety during pregnancy predict the severity of postpartum depression symptoms. According to etiological models, reproductive and stress hormones rise during birth and then drop abruptly afterward.

### **Psychosocial & Psychological Risk Factors**

Depression/anxiety during pregnancy is one of the key contributing causes, which can be categorised as strong to moderate risk factors. A study was conducted to determine the extent and forecast levels of delivery disappointment, additionally the risk of puerperal depression, among singleton pregnant women above the age of 18. [5]. This study gathered obstetric data that was connected to anxiety related to pregnancy and delivery, and that also predicted puerperal depression. The pregnancy and delivery problems were not mentioned here. Continuous episodes of depression or anxiety throughout the pregnancy were found to be the strongest predictors of puerperal depression. Furthermore, higher levels of anxiety throughout the pregnancy were linked to a higher rate of postpartum depression symptoms [11].

### **Previous History of Psychiatric Illness**

It is known as one of the greatest risk factors of puerperal depression. Studies reveal those previous episodes of depressive symptoms at any time of life & not only related to childbirth may also lead to a significantly greater risk of puerperal depression [12]. The major difficulty in tracing the past family/personal history of previous mental illness is the patient's non-compliance and incomplete information provided by relatives/family members. A cross-sectional study accompanied in a community of 295 women after delivery to identify the affiliate factors of postnatal depression among women [9]. The authors used a structured questionnaire to identify the independent variables that are associated with PPD by using multivariable logistic regression. The result shows 20.9 % has developed PPD out of which 3.95% are associated with the history of substance abuse, 5.92% with domestic violence, unplanned pregnancy, 7.84 with the first pregnancy, and 3.95% with the previous history of depression. A population-based cross-sectional study in the rural population evaluates the generality of postpartum depression and its health-care consumption pattern among newly delivered women [13]. The authors assessed women after 42 days of delivery by using Edinburgh postnatal depression scale. Results show institutional deliveries are 97.8%, prevalence 11% and 42.5 % of those who have a history of depression before pregnancy and only 7.5% of women are taking health care facilities for their problem to reduce symptoms.

### **Significant Life Events**

There is a link between the start of depression and the occurrence of definite life episodes during one's lifetime [7]. Experiences like: loss of beloved ones, relationship breakups or divorce, unstable financial conditions, losing the job, or leaving home are the main causes [known till now] of stress and it too can cause depressive episodes/symptoms in people with no previous episodes of affective disturbance. Pregnancy and childbirth are often considered as the most stressful events of life and this stress may altogether lead to depression. A cohort longitudinal study conducted on 161 Italian women intending to investigate various types of risk factors of PPD during first child pregnancy [14]. The authors assessed data on socio-demographic, prenatal anxiety, close relationship with the family at the week of 31-32 of pregnancy, clinical data of labor and childbirth on delivery, and the symptoms of depression after one month of delivery. Prenatal attachment appears to play a role in the development of postpartum depression, additionally some clinical delivery issues, according to the findings.





Prerna Sharma et al.,

### Social Support

A model constructed to determine the levels of PPD which constituted the difficult infant temperament as a source of stressor/source of depression [15], whereas positive social support from near & dear ones, family members, and friends proved to reduce the levels of depression. Stressful living events combined with unsupportive social interactions might lead to an increase in PPD levels that is directly proportionate [16]. A cross-sectional study was done on 257 mothers using a patient health questionnaire for depression screening and interventions by 56 health workers, employing a quantitative approach to detect the prevalence of depression among women after delivery and interventions for its treatment [1]. According to the findings, 7% of women suffer from mild to severe depression, and psychosocial assistance has been demonstrated to be a beneficial intervention in lowering the symptoms of postpartum depression. Sit & Wisner [17] conducted a community based, prospective follow-up study to determine and test the risk factors associated with demographic, obstetric, and psychosocial causing agents responsible for postpartum depression. During pregnancy, psychological distress and social help were examined, as well as depression four weeks following birth. According to the findings, around 5.5 percent of the women experienced postpartum depression. Psychological discomfort in late pregnancy and a sense of social alienation during pregnancy were both risk factors for PPD.

### Screening and Diagnosis

Different epidemiological tools are suggested to screen PPD in different studies.

#### Edinburgh Postnatal Depression Scale [EPDS]

The Edinburgh Postnatal Depression Scale [EPDS] is the mostly used measure for screening PPD. It is tactful and specified for both diagnosing and treating PPD [18]. This Questionnaire comprises ten questions in which the mother is requested to complete the Questionnaire, which is easily legible and evaluates a patient's state of mind during the previous week, and is distributed at the 6-week postpartum visit to the mother or at the two-month baby checkup [19]. The total score is 30, and a mother with a score of more than 13 is likely to be depressed [20]. To confirm the diagnosis, the EPDS score should be connected clinically. Wikinsen.A. et.al [21] conducted a cohort study on 1000 one live birth pregnant women to analyze the cost-effective model for screening and treatment for postpartum depression. The authors employed an EPDS tree model and found that the cost per quality-adjusted life-year was worthwhile [QALY]. The incremental cost-effectiveness ratios of the intervention compared to conventional care are \$13,857 per QALY gained and \$10,182 per restitution gained, according to the findings.

#### The Center for Epidemiologic Studies of Depression instrument [CES-D]

The CES-D is a 20-item questionnaire with excellent sensitivity and specificity that has been used to test extensive reach of people, including adolescent moms, for depression [22]. This questionnaire, which is based on the last seven days' symptoms and outcomes that remain constant for the first twelve months after delivery, indicates that the mother is depressed. Scores >16 indicate depression in the mother.

#### The Bromley Postnatal Depression Scale [BPDS]

This scale is a specific Questionnaire which includes 10 items, [23] in this questionnaire patient asks to write down the details of your symptoms as when it started and when was it worse and how much time it will take to decrease your symptoms to look out for the diagnoses of postpartum depression.

#### The Postpartum Depression Screening Scale [PDSS]

This scale has been used for screening mothers for postpartum depression from qualitative interviews on the telephone to explore the mother's experience after delivery [24]. It contains Seven items for initial screening, a score of PDSS>14 uses with 28 additional items, score > 60 predicts mild to moderate depression [8, 25], and score more than 80 considered as highly predictive of severe depression after childbirth. These instruments are useful, but they should be used along with clinical findings. Table 2 reveals major depressive disorder [26], which is signalled by a practical symptom of 5 or more symptoms present for most of the day, almost every day for minimum of 2 weeks to





**Prerna Sharma et al.,**

make a diagnosis of PPD, according to the DSM-V [16]. Boyd *et al.* [23] identified more tools with acceptable psychometric properties for screening postnatal symptoms in their review. These instruments comprise the General Health Questionnaire which is used by medical practitioners to identify psychiatric manifestations in four categories of social interaction functioning, depression, substantial symptoms such as pain, weakness, or conciseness of breath that could be responsible for major distress [27]. Beck Depression catalog [BDI or II] and the Inventory of Psychotic Symptomatology [IDS – 28-item person-report OR 30-item disorders analyst-evaluated catalog]. Recent evidence reveals that symptom onset within the first three months is another clinically communist standard, and that PPD symptoms can appear at any time throughout the first twelve months after a child's birth.

### Interventions

Research and journal articles back up the idea that postpartum depression can be treated with a variety of treatments aimed at identifying and eliminating the problem's fundamental cause. Non-pharmacological and pharmaceutical interventions are both possible. Because of worries about infants being exposed to antidepressant side effects through breast milk, non-pharmacological therapies such as psychotherapy and psychosocial support are considered to be the ideal treatment [28]. Interpersonal psychotherapy and cognitive therapy are other lines of treatment. However, the most effective approach among these interventions is psychosocial support. Holden found that the percentage of recovery from psychosocial unstructured therapies was much higher [69%] than the control group [38%] and that interpersonal psychotherapy, as well as cognitive therapy, were ineffective in reducing depressed symptoms. This implied that psychosocial assistance was the most effective technique among these therapies [1,29]. However, compared to the control group, O'Hara *et al.* [30] found that 120 randomised women with PPD who got 12 weeks of 60 minute individual single sessions of psychotherapy from educated therapists showed a substantial decrease in depression symptoms and improved social adjustment. One more study by Clark *et al.* [31] found that interpersonal psychotherapy is effective in reducing depressed symptoms in women and fostering a positive mother-infant interaction in PPD. Important studies incorporating different interventions are presented briefly in table 3.

### Pharmacological Interventions

Various studies have shown that using an antidepressant to treat postpartum depression is safer. In the studies given in table 3, several drugs [antidepressants] were used to assist limit the symptoms of depression in mothers. However, it is challenging for moms and physicians to take antidepressants while a woman is lactating because breastfeeding provides numerous benefits for both the mother and the kid. Antidepressants are not safe in the first six months, according to several studies. It's also been suggested that if antidepressants are needed, Sertraline and paroxetine [32] should be used with caution because their evacuation in breast milk is poor [33]. However, because paroxetine has been associated to increase cardiac effects in growing fetuses, it should be avoided or used with caution [34]. Table 4 summaries several studies on pharmaceutical alternatives.

### Psychological and Psychosocial Interventions for Postpartum Depression

Due to concern of side effects and exposure to infants from medications many mothers do not want to go for medical treatment. So they prefer non-directive counseling. [35], however, only a few studies prove the effectiveness of non-pharmacological interventions over pharmacological interventions but existing researches support the use of psychological as well as psychosocial interventions including interpersonal therapy [36], cognitive-behavior therapy, and psychodynamic therapy in limiting the symptoms of depression in PPD.

### Interpersonal Therapy

IPT is both a time-bounded and problem-oriented approach that fulfills the demands of a postpartum mother who's suffering from major depression. This intervention addresses the condition, based on the severity of the connection between mood and personal problems [37]. Out of four [role dispute, interpersonal deficits, role transition, and grief], the clinician and mother have to select one area of the problem. This therapy lasts 12-20 weeks [29,31], during which time the clinician addresses complicated areas related to depression, with a focus on the mother-infant relationship and their family, and tries to assist patients in putting their problems into perspective and making a





**Perna Sharma et al.,**

transition back to normal, which leads to better social support. Kao.J.C *et al.* [38] investigated whether a group interpersonal psychotherapy intervention can help people avoid developing PPD. The authors used Reach out [ROSE], Stand strong, improving social support, and interpersonal skills in ninety-nine pregnant women during the transition of low-income women into parenthood, which can improve breastfeeding results. The result shows women with ROSE intervention have longer breastfeeding duration with a median of 54 versus 21 breastfeeding days.

### **Cognitive-Behavioral Therapy [CBT]**

This therapy is precise and efficacious in limiting symptoms of major depression in postpartum which is found to be based on perception and behavior [39] associated with mood likely helpful in behavioral changes and optimal in making positive thinking that can manage distress and reduce symptoms [40]. Several researches have been conducted to determine the effectiveness of CBT in the postpartum period. On the one hand, Appleby *et al.* [41] conducted a randomised controlled psychotherapy-pharmacotherapy study on 87 postpartum women, finding that six CBT sessions with placebo pills is an effective approach in reducing depression symptoms, whereas Prendergast and Austin [40] conducted a study on 37 postpartum mothers. After six weeks of one-hour private CBT sessions, no significant differences in lowering depression symptoms in women treated with CBT versus pharmaceutical therapy in mothers with postpartum depression were reported [30].

### **Nondirective Counseling**

Person-centered or psychosocial interventions include peer support and nondirective counseling to mothers with PPD. It is based on the use of sympathetic and nonjudgmental permissive listening and helps to deal with symptoms and try to overcome that [33]. A study conducted on 50 randomized women with PPD by Holden provides 8 weekly home-based psychosocial counseling sessions to women found 69% more recovery from PPD as compared to 38% of the control group. Figure 1 depicts the effectiveness of psychosocial support [34%], cognitive therapy [18%], Interpersonal Psychotherapy [20%], and professionally based support therapy [28%], as well as other therapies, in lowering the symptoms of women with postpartum depression. As a result, it could be utilised as a first-line therapy.

### **Hormone Therapy**

During delivery, there is a shift in hormone levels. Some studies suggest estrogen and progesterone shift to lower side during delivery can cause mood disorder on women [42], which has a history of depression as these hormones responsible for neurotransmitter activity of the brain. Gregoire *et al.* [43] conducted a double-blind placebo-controlled study on sixty-one women with PPD and found that oestrogen receiving women had more refinement in limiting the depressive symptoms on the Edinburgh Postnatal depression scale [44]. A small preventive study also suggests that a small level of oestrogen hormone administration after delivery can reduce the chances of PPD occurrence [33]. The role of progesterone hormone in the treatment of patients is still unknown.

### **Additional Therapeutic Options**

Because of the negative consequences of pharmacological therapies on breastfeeding and the stigma associated with mental illness, most women opt for non-pharmacological approaches to alleviate PPD symptoms. Other modalities like exercise, bright light therapy, massage, electroconvulsive therapy, acupuncture, and PUFA may be useful in diminishing symptoms in women with PPD [45] but it has been not much-proved efficacy over pharmacological interventions because of limiting researches but these are safe to use and may add to other health benefits.

### **Electroconvulsive Therapy**

According to the findings of a small study involving five women, ECT may be a choice for treating mothers who are depressed after giving birth, and the possibility of anaesthetic chemicals used in ECT being transmitted to breast milk can be reduced because it is swiftly digested [1,46].

### **Bright Light Therapy**

Some studies suggest its effectiveness in the reduction of depression with low risk of effects on infants [47]. More studies are needed to show the usefulness of bright light therapy in the treatment of postpartum depression [48].





Prerna Sharma *et al.*,

### Omega-3 Fatty Acids

Omega-3 fatty acids [eicosapentaenoic and docosahexaenoic acid] rich dietary products help in the maturation of the central nervous system of infants [10] and also found to be positive effects in mood change with PPD. According to one of the cross-national research, the consumption of omega 3 fatty acid-rich foods is inversely linked to the risk of postpartum depression. In a double-blind, placebo-controlled research, 3.4 gm of fatty acids per day was found to be associated with a limitation in depressive symptoms in mothers with PPD [49]. Although the efficacy of omega 3 fatty acid intervention in treating moms with PPD has been inconsistent in several epidemiological research.

### Acupuncture

It is a traditional Chinese intervention that involves inserting and operating the needles into various target sites on the body to cure pain [50]. Studies on the efficacy of acupuncture in lowering depressed symptoms in people with PPD have yielded inconsistent results, although a small pilot research conducted by Manber *et al* in moms with PPD who received an 8-week acupuncture intervention indicated depletion in depression symptoms in a target group [51]. Although some research suggest that acupuncture can be used to alleviate the nausea and induce labour in pregnant women.

### Exercise

Despite the limitations of studies on the role of exercise in lowering depression symptoms, some studies indicates that in the postpartum period, moderate-intensity workouts such as a brisk walk for minimum of 30 minutes five days a week can help to combat PPD. In 2009, Da Costa *et al.* conducted a randomised research on 88 women with PPD who were given a home-based 12-week [52-week] exercise programme. The results showed a decrease in depressed symptoms on the depression rating scale. The National Institute for Health and Clinical Excellence in the United Kingdom also offers guidelines for the use of exercises in prenatal and postnatal care for depression management [53].

## CONCLUSION

Postpartum depression is a major medical problem that is frequently misdiagnosed and ignored due to social concerns. Despite the fact that India's national mental health programme was launched in 1982, maternal mental health and related issues are still not a focus of the programme. The major reason of such neglect is a lack of specific maternal mental health-related services in various health-care facilities, additionally a shortage of educated mental health specialists [54]. According to the current study, the global prevalence of puerperal depression is predicted to be 13%. Many risk factors contribute to the development of maternal postpartum depression, which impacts the infant, mother, family, and society as a whole [55]. Family members, as well as physicians, have an important role in diagnosing PPD symptoms. High stress levels, a limitation of social support, current or previous occurrences of molestation/abuse, prenatal depression, and marital or relationship dissatisfaction are the most common risk factors. Physicians must closely monitor women from the prenatal stage to up to 12 months after delivery, screening them at every visit, and initiating first-line treatment as soon as possible if they meet DSM-5 criteria for PPD. If necessary, pharmacological therapies should be employed to alleviate PPD symptoms. The findings demonstrate that psychosocial [e.g., peer support, non-directive counselling] and psychological [e.g., cognitive behavioural therapy and interpersonal psychotherapy] therapies are more effective in lowering puerperal depression symptoms. Postpartum depression affects not just the mother, but also the entire family. Larger trials examining psychosocial and psychological treatments for puerperal depression are required to draw firm findings about specific intervention approaches and their advantages. Avoidance or inadequate treatment may result in the mother's death, which will have a negative impact on the kid and family. Effective treatment and prompt interventions help to lower maternal and infant mortality rates, which reduces the burden of mental illness and contributes to the accomplishment of the third Sustainable Goal.

**Source of Support:** Nil





**Perna Sharma et al.,**

**Declaration of Interest:** None

## REFERENCES

1. Anokye R, Acheampong E, Budu-Ainooson A, Obeng EI, Akwasi AG. Prevalence of affective disorders. 2016 Feb 1;191:62-77.
2. Slomian J, Honvo G, Emonts P, Reginster JY, Bruyère O. Consequences of maternal postpartum depression: A systematic review of maternal and infant outcomes. *Women's Health*. 2019 Apr;15:1745506519844044.
3. Chandran M, Tharyan P, Muliylil J, Abraham S. Post-partum depression in a cohort of women from a rural area of Tamil Nadu, India: Incidence Anokye R, Acheampong E, Budu-Ainooson A, Obeng EI, Akwasi AG. Prevalence of postpartum depression and interventions utilized for its management. *Annals of general psychiatry*. 2018 Dec 1;17[1]:18.
4. Dennis CL, Chung-Lee L. Postpartum depression help-seeking barriers and maternal treatment preferences: A qualitative systematic review. *Birth*. 2006 Dec;33[4]:323-31.
5. Biaggi A, Conroy S, Pawlby S, Pariante CM. Identifying the women at risk of antenatal anxiety and depression: a systematic review. *Journal and risk factors. The British Journal of Psychiatry*. 2002 Dec;181[6]:499-504.
6. Shriram V, Shah PB, Rani MA, Sathiyasekaran BW. A community-based study of postpartum depression in rural Southern India. *Indian Journal of Social Psychiatry*. 2019 Jan 1;35[1]:64.
7. Sahithya BR, Reddy RP. Burden of mental illness: a review in an Indian context. *International Journal of Culture and Mental Health*. 2018 Oct 2;11[4]:553-63.
8. Baker L, Cross S, Greaver L, Wei G, Lewis R, CORPS HS. Prevalence of postpartum depression in a native American population. *Maternal and child health journal*. 2005 Mar 1;9[1]:21-5.
9. Abadiga M. Magnitude and associated factors of postpartum depression among women in Nekemte town, East Wollega zone, west Ethiopia, 2019: A community-based study. *PLOS ONE*. 2019;14[11]:e0224792.
10. Golding J, Steer C, Emmett P, Davis JM, Hibbeln JR. High levels of depressive symptoms in pregnancy with low omega-3 fatty acid intake from fish. *Epidemiology*. 2009 Jul 1;20[4]:598-603.
11. Omidvar S, Faramarzi M, Hajian-Tilak K, Amiri FN. Associations of psychosocial factors with pregnancy healthy life styles. *PloS one*. 2018;13[1].
12. Ghaedrahmati M, Kazemi A, Kheirabadi G, Ebrahimi A, Bahrami M. Postpartum depression risk factors: A narrative review. *Journal of education and health promotion*. 2017;6.
13. Patel HL, Ganjiwale JD, Nimbalkar AS, Vani SN, Vasa R, Nimbalkar SM. Characteristics of postpartum depression in Anand district, Gujarat, India. *Journal of tropical pediatrics*. 2015 Oct 1;61[5]:364-9.
14. Smorti M, Ponti L, Pancetti F. A comprehensive analysis of post-partum depression risk factors: the role of socio-demographic, individual, relational, and delivery characteristics. *Frontiers in public health*. 2019;7:295.
15. Kerie S, Menberu M, Niguse W. Prevalence and associated factors of postpartum depression in Southwest, Ethiopia, 2017: a cross-sectional study. *BMC research notes*. 2018 Dec 1;11[1]:623.
16. Wisner KL, Moses-Kolko EL, Sit DK. Postpartum depression: a disorder in search of a definition. *Archives of women's mental health*. 2010 Feb 1;13[1]:37-40.
17. Wisner KL, Perel JM, Peindl KS, Hanusa BH, Piontek CM, Findling RL. Prevention of postpartum depression: a pilot randomized clinical trial. *American Journal of Psychiatry*. 2004 Jul 1;161[7]:1290-2.
18. Gollan JK, Wisniewski SR, Luther JF, Eng HF, Dills JL, Sit D, Ciolino JD, Wisner KL. Generating an efficient version of the Edinburgh Postnatal Depression Scale in an urban obstetrical population. *Journal of affective disorders*. 2017 Jan 15;208:615-20.
19. Felice E, Saliba J, Grech V, Cox J. Validation of the Maltese version of the Edinburgh postnatal depression scale. *Archives of women's mental health*. 2006 Mar 1;9[2]:75-80.
20. Adouard F, Glangeaud-Freudenthal NM, Golse B. Validation of the Edinburgh postnatal depression scale [EPDS] in a sample of women with high-risk pregnancies in France. *Archives of Women's Mental Health*. 2005 Jun 1;8[2]:89-95.
21. Sit DK, Wisner KL. The identification of postpartum depression. *Clinical obstetrics and gynecology*. 2009 Sep;52[3]:456.





**Purna Sharma et al.,**

22. Corrigan CP, Kwasky AN, Groh CJ. Social support, postpartum depression, and professional assistance: A survey of mothers in the Midwestern United States. *The Journal of perinatal education*. 2015 Jan 1;24[1]:48-60.
23. Boyd RC, Le HN, Somberg R. Review of screening instruments for postpartum depression. *Archives of women's mental health*. 2005 Sep 1;8[3]:141-53.
24. Beck CT, Gable RK. Comparative analysis of the performance of the Postpartum Depression Screening Scale with two other depression instruments. *Nursing research*. 2001 Jul 1;50[4]:242-50.
25. Moraes GP, Lorenzo L, Pontes GA, Montenegro MC, Cantilino A. Screening, and diagnosing postpartum depression: when and how?. *Trends in psychiatry and psychotherapy*. 2017 Mar;39[1]:54-61.
26. Guille C, Newman R, Fryml LD, Lifton CK, Epperson CN. Management of postpartum depression. *Journal of midwifery & women's health*. 2013 Nov;58[6]:643-53.
27. Froman RD, Bernal H. Acculturation level and postpartum depression in Hispanic mothers. *MCN: The American Journal of Maternal/Child Nursing*. 2005 Sep 1;30[5]:299-304. 50[4]:242-250.
28. Corral M, Wardrop AA, Zhang H, Grewal AK, Patton S. Morning light therapy for postpartum depression. *Archives of women's mental health*. 2007 Oct 1;10[5]:221-4.
29. Evans K, Spiby H, Morrell JC. Non-pharmacological interventions to reduce the symptoms of mild to moderate anxiety in pregnant women. A systematic review and narrative synthesis of women's views on the acceptability of and satisfaction with interventions. *Archives of women's mental health*. 2019 Jan 7:1-8.
30. O'Hara MW, Stuart S, Gorman LL, Wenzel A. Efficacy of interpersonal psychotherapy for postpartum depression. *Archives of general psychiatry*. 2000 Nov 1;57[11]:1039-45.
31. Clark R, Tluczek A, Wenzel A. Psychotherapy for postpartum depression: a preliminary report. *American Journal of Orthopsychiatry*. 2003 Oct;73[4]:441-54.
32. Sie SD, Wennink JM, Van Driel JJ, te Winkel AG, Boer K, Casteelen G, van Weissenbruch MM. Maternal use of SSRIs, SNRIs and NaSSAs: practical recommendations during pregnancy and lactation. *Archives of Disease in Childhood-Fetal and Neonatal Edition*. 2012 Nov 1;97[6]:F472-6.
33. Fitelson E, Kim S, Baker AS, Leight K. Treatment of postpartum depression: clinical, psychological and pharmacological options. *International journal of women's health*. 2011;3:1.
34. Stephens S, Ford E, Paudyal P, Smith H. Effectiveness of psychological interventions for postnatal depression in primary care: a meta-analysis. *The Annals of Family Medicine*. 2016 Sep 1;14[5]:463-72.
35. Pearlstein TB, Zlotnick C, Battle CL, Stuart S, O'Hara MW, Price AB, Grause MA, Howard M. Patient choice of treatment for postpartum depression: a pilot study. *Archives of women's mental health*. 2006 Nov 1;9[6]:303-8.
36. Dennis CL, Hodnett ED. Psychosocial and psychological interventions for treating postpartum depression. *Cochrane database of systematic reviews*. 2007[4].
37. Klier CM, Muzik M, Rosenblum KL, Lenz G. Interpersonal psychotherapy adapted for the group setting in the treatment of postpartum depression. *The Journal of psychotherapy practice and research*. 2001;10[2]:124.
38. Kao JC, Johnson JE, Todorova R, Zlotnick C. The positive effect of a group intervention to reduce postpartum depression on breastfeeding outcomes in low-income women. *International journal of group psychotherapy*. 2015 Jul 1;65[3]:445-58.
39. Freeman M. Postpartum Depression Treatment and Breastfeeding. *The Journal of Clinical Psychiatry*. 2009;70[9]:e35.
40. Prendergast J, Austin MP. Early childhood nurse-delivered cognitive behavioural counselling for post-natal depression. *Australasian Psychiatry*. 2001 Sep;9[3]:255-9.
41. Stamou G, García-Palacios A, Botella C. Cognitive-Behavioural therapy and interpersonal psychotherapy for the treatment of post-natal depression: a narrative review. *BMC psychology*. 2018 Dec 1;6[1]:28.
42. Yim IS, Stapleton LR, Guardino CM, Hahn-Holbrook J, Schetter CD. Biological and psychosocial predictors of postpartum depression: systematic review and call for integration. *Annual review of clinical psychology*. 2015 Mar 30;11.
43. Kim S, Soeken TA, Cromer SJ, Martinez SR, Hardy LR, Strathearn L. Oxytocin and postpartum depression: delivering on what's known and what's not. *Brain research*. 2014 Sep 11;1580:219-32.
44. Dennis CL, Chung-Lee L. Postpartum depression help-seeking barriers and maternal treatment preferences: A qualitative systematic review. *Birth*. 2006 Dec;33[4]:323-31.





**Prerna Sharma et al.,**

45. Thompson KS, Fox JE. Post-partum depression: A comprehensive approach to evaluation and treatment. *Mental health in family medicine*. 2010 Dec;7[4]:249.
46. Payne NA, Prudic J. Electroconvulsive therapy part II: A biopsychosocial perspective. *Journal of psychiatric practice*. 2009 Sep;15[5]:369.
47. Bais B, Kamperman AM, van der Zwaag MD, Dieleman GC, van der Vliet HW, Bijma HH, Lieveerse R, Hoogendijk WJ, Lambregtse-van den Berg MP. Bright light therapy in pregnant women with major depressive disorder: study protocol for a randomized, double-blind, controlled clinical trial. *BMC psychiatry*. 2016 Dec;16[1]:381.
48. Epperson CN, Terman M, Terman JS, Hanusa BH, Oren DA, Peindl KS, Wisner KL. Randomized clinical trial of bright light therapy for antepartum depression: preliminary findings. *Journal of Clinical Psychiatry*. 2004 Mar 3;65[3]:421-5.
49. Diao GY, Hsieh AT, Sarkadi-Nagy EA, Wijendran V, Nathanielsz PW, Brenna JT. The influence of long chain polyunsaturate supplementation on docosahexaenoic acid and arachidonic acid in baboon neonate central nervous system. *BMC medicine*. 2005 Dec;3[1]:11.
50. Mukaino Y, Park J, White A, Ernst E. The effectiveness of acupuncture for depression—a systematic review of randomised controlled trials. *Acupuncture in Medicine*. 2005 Jun;23[2]:70-6.
51. Manber R, Schnyer RN, Lyell D, Chambers AS, Caughey AB, Druzin M, Carlyle E, Celio C, Gress JL, Huang MI, Kalista T. Acupuncture for depression during pregnancy: a randomized controlled trial. *Deutsche Zeitschrift für Akupunktur*. 2010 Apr 1;53[2]:43-5.
52. Da Costa D, Lowensteyn I, Abrahamowicz M, Ionescu-Ittu R, Dritsa M, Rippen N, Cervantes P, Khalifé S. A randomized clinical trial of exercise to alleviate postpartum depressed mood. *Journal of Psychosomatic Obstetrics & Gynecology*. 2009 Jan 1;30[3]:191-200.
53. Daley AJ, MacArthur C, Winter H. The role of exercise in treating postpartum depression: a review of the literature. *Journal of midwifery & women's health*. 2007 Jan 2;52[1]:56-62.
54. Shidhaye PR, Giri PA. Maternal depression: a hidden burden in developing countries. *Annals of medical and health sciences research*. 2014;4[4]:463-5.
55. Field T. Prenatal depression risk factors, developmental effects and interventions: a review. *Journal of pregnancy and child health*. 2017 Feb;4[1].

**Table 1: Classification of Risk Factors for PPD**

	Biological (Relation/Factors)	Psychosocial & Psychological
1.	Endocrine System	Previous History Of Psychiatric complaint
2.	Immune System	Anxiety/Depression
3.	Genetic Factors	Life Events
4.	Deficient Factors	Social support

**Table 2: Criteria for diagnosis & depressive symptomatology**

DSM-V Diagnosis of major Depression Criteria:	Suggestive of Postpartum Depression
Depressed Mood	A regretful or gloomy emotion that lasts for minimum of two weeks on a daily basis.
Shortage of happiness or Interest in Activities	Inability to dispossess pleasure from experience or lack of attentiveness in things that are usually enjoyable.
Sleep disruption	Inability to rest or sleep when the child is sleeping or incapacity to safekeeping for baby because of hypersomnia.
Loss of liveliness	Continues not resent sufficient sleep or napping.
Perturbation or slowness	Moving or talking so steadily that has others noticed or being so restless that one is powerless to sit still.
Excessive feeling of culpability or inadequacy	Apprehension badly about her like a non-fulfillment or have let self or family down.





Prerna Sharma et al.,

Reduced concentration or ambivalent	Regularly losing aspiration or belief incapacity to make decisions.
Recurrent thoughts of death or suicide	"I hope I didn't wake up," "my baby would be better off without me," or the desires, wants, or plan to end one's life.

**Table 3: Interventions for PPD**

	<b>Interventions</b>	<b>Authors</b>	<b>Research Title</b>
1.	Pharmacology	Stephens S, Ford E, Paudyal P, Smith H, 2016.	Effectiveness of psychological interventions for postnatal depression in primary care: a meta-analysis.
2.	Psychological and Psychosocial	Pearlstein TB, Zlotnick C et al. 2006	Patient choice of treatment for postpartum depression: a pilot study.
3.	Interpersonal Therapy	Clark R, Tluczek A, Wenzel A. et al. 2003	Psychotherapy for Postpartum Depression:
4.	Cognitive-behavioral Therapy	Thompson KS, Fox JE., 2010.	A comprehensive approach to evaluation and treatment.
5.	Non-directive Counselling	Fitelson, Kim, S., Baker, A.S. &Leight, K. 2010.	Treatment of Postpartum Depression: Clinical, Psychological and Pharmacological Options
6.	Hormone Therapy	Kim S, Soeken TA, Cromer SJ, Martinez SR, Hardy LR, Strathearn L. 2014.	Oxytocin and postpartum depression: delivering on what's known and what's not.
7.	Electroconvulsive Therapy	. Payne NA, Prudic J, 2009.	Electroconvulsive Therapy Part II: A Biopsychosocial Perspective
8.	Bright-light Therapy	Corral M, Wardrop A, Zhang H, Grewal AK, Patton S. 2007	Morning Light Therapy for Postpartum Depression
9.	Omega-3 fatty acids	Golding J, Steer C, Emmett P, Davis JM, Hibbeln JR. 2009	High Levels of Depressive Symptoms in Pregnancy With Low omega-3 Fatty Acid Intake From Fish
10.	Acupuncture	Manber R, Schnyer RN, Lyell D, et al. 2010	Acupuncture for Depression During Pregnancy:
11	Exercise	Da Costa D, Lowensteyn I, Abrahamowicz M, et al. 2009	A Randomized Clinical Trial of Exercise to Alleviate Postpartum Depressed Mood

**Table -4 Various Reliable Pharmacologic Options**

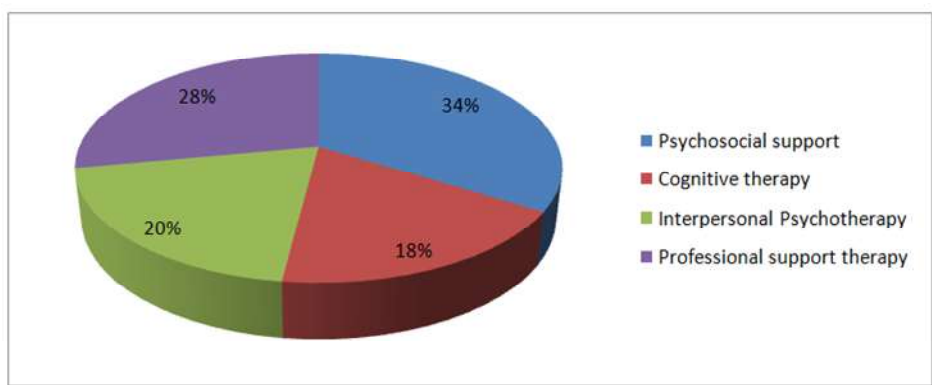
<b>Medications</b>	<b>Author</b>	<b>Name of research</b>
Sertraline (Zoloft)	Sie SD, Wennink JMB, Van Driel JJ, et al. 2012.	Management of Postpartum Depression
Paroxetine (Paxil)	Lanza di Scalea, T., & Wisner, K. L. 2009.	Antidepressant Medication Use During Breastfeeding
Citalopram (Celexa)	Franssen, E J F PharmD, Ph.D. Meijs et al. 2006	Status of PharmD/Ph.D. Programs in Colleges of Pharmacy: The University of Tennessee Dual PharmD/PhD Program
Escitalopram (Lexapro)	Freeman MP, Joffe H, Cohen LS. 2011	Management of Postpartum Depression
Fluoxetine (Prozac)	Lanza di Scalea, T., & Wisner, K. L. 2009.	Antidepressant Medication Use During Breastfeeding





**Prerna Sharma et al.,**

Venlafaxine (Effexor)	Guille, C., Newman, R., Fryml, L. D., Lifton, C. K., & Epperson, C. N. 2013.	Management of Postpartum Depression
Bupropion (Wellbutrin)	Chaudron LH, Schoenecker CJ. 2004	Bupropion and Breastfeeding: A Case of a Possible Infant Seizure
Mirtazapine (Remeron)	Guille, C., Newman, R., Fryml, L. D., Lifton, C. K., & Epperson, C. N. 2013.	Management of Postpartum Depression



**Figure 1 : Effectiveness of Interventions in PPD (1)**





## Positivity at Work-Place: A Comparative Investigation

Vaishali N. Choudhari\*

Assistant Professor, Department of Psychology, MGM University, Maharashtra, India.

Received: 16 July 2021

Revised: 23 Oct 2021

Accepted: 12 Jan 2022

### \*Address for Correspondence

**Vaishali N. Choudhari**

Assistant Professor,

Department of Psychology,

MGM University,

Maharashtra, India India.

Email: vaishalichoudhari9@gmail.com



This is an Open Access Journal / article distributed under the terms of the **Creative Commons Attribution License** (CC BY-NC-ND 3.0) which permits unrestricted use, distribution, and reproduction in any medium, provided the original work is properly cited. All rights reserved.

### ABSTRACT

The COVID-19 pandemic has engraved a major impact on our lives. Many of us are facing challenges those are painful, stressful, overwhelming, and cause strong negative emotions in adults and children. Public health actions, such as social distancing, are necessary to reduce the spread of COVID-19, but they can make us feel isolated and lonely and can increase stress and anxiety. Present investigation was aimed at studying the five pillars of mental health i.e. PERMA (positive emotions, engagement, relationship, meaning, accomplishment & health) among employees with respect to gender. This study included total 86 employees participants (43 male & 43 females) with age ranging from 35 to 55 years. For assessment, Work-place PERMA Profiler developed by Margaret L. Kern (2014) was used. Data were analysed by using *t*-statistic. Results revealed the significant difference in case of Positive emotions, Engagement, Relationship and Meaning at work-place with respect to gender. Male employees scored significantly higher in positive emotions and relationship at work-place while female employees scored significantly higher in engagement and meaning at work-place. The study ended with the conclusion that pandemic has some effect on mental health dimension of employees with respect to gender.

**Keywords:** Pandemic, gender, positive emotions, engagement, relationship, meaning, accomplishment & health:

### INTRODUCTION

Wellbeing is related to our health, happiness, opportunities and the overall quality of life. It is a positive outcome in life which is meaningful for people and for many areas in the society, because it makes us aware that people perceive that their lives are going well. Good living conditions (e.g., housing, employment) are fundamental to well-being. Sometime measuring living conditions of people seems to be difficult. It includes what people think and feel about their lives, such as the quality of their relationships, their positive emotions and resilience, the realization of their



**Vaishali N. Choudhari**

potential, or their overall satisfaction with life - i.e., their “well-being.” Well-being generally includes global judgments of life satisfaction and feelings ranging from depression to joy. Well-being is an umbrella term which includes the presence of positive emotions and moods (e.g., contentment, happiness), the absence of negative emotions (e.g., depression, anxiety), and satisfaction with life, fulfilment and positive functioning. In simple terms, it can be described as seeing the life positively and feeling good. For public health purposes, physical well-being (e.g., feeling very healthy and full of energy) is also viewed as crucial to overall well-being.

In covid-19 situation, well-being concept has been hampered in all over the world. During this pandemic some people got infected, some people lost their lives, some people lost their dear ones and some people lost their jobs because of this corona. Some people are still working but they have feeling of insecurity of losing job. It is difficult to maintain a healthy lifestyle when we are in the middle of a crisis like this. This uncertain situation, financial insecurity, childcare, old-age parents, and job insecurity hampered our routines as well as our lifestyles and mental health. The uncertainty about the future, the ceaseless news coverage and constant social media driven flood of messages can increase our sense of anxiety. This entire situation affected complete well-being of person. Present study aims to find the impact of pandemic on the overall well-being of employees with the help of PERMA profile which assesses positive emotions, engagement, relationship, meaning, accomplishment and health factors among male as well as female employees. Important goal of the study is to assess mentioned variables with the comparison between male and female employees. This assessment helps to provide therapeutic assistance which enhance and improve the total well-being of individual so that he/she will be more productive towards their lives, family as well as towards the organization. The rest of the paper is structured as follows: Section 2 underlines the literature review leaving research questions towards its close; Section 3 provides a discussion on the research methodology adopted for the present study; Section 4 covers the results and discussion of the findings and Section 5 concludes the study besides underlining the limitations and pointers for further research.

**Review of literature**

According to world Economic Forum, 2020, this situation can have a negative impact on business sustainability and individual employment. In fact, this has triggered furloughs and layoffs. Psychological distress and major depression that can result from a pandemic or an epidemic. [1][2][3][4][5] Organizational and employment aspects have a considerable impact on psychological health, especially in the context of a global pandemic. The workplace therefore represents an important target towards which efforts should be directed to manage mental health issues related to the COVID-19 pandemic. Mental issues related to the health emergency, such as anxiety, depression, PTSD, suicidal ideas, sleep disorders, and drugs and alcohol addiction are more likely to affect healthcare workers, especially those on the frontline, migrant workers and workers in contact with the public, like the law enforcement. [6] People are surrounded by various uncertainties and risks that are ultimately affecting their mental fitness. [7] The current pandemic situation has severely hit various aspects of businesses and economy. [8][9]

**Rationale of the study**

Everyone has been affected by recent pandemic. In getting adjusted with a new work life situation, loss of jobs, loss of loved ones, feeling of insecurity and uncertainty significantly impacted our mental health. This investigation will help the people to know about their mental health condition, their work style and their productivity towards the organization and in this way, they can work on the area in which they are at risk. Finally, they will be able to understand the importance mental health at work place.

**Objective of the study**

This purpose of the investigation is to analyse the mental health dimensions i.e. PERMA (positive emotions, engagement, relationship, meaning, accomplishment & health) among employees with respect to gender. The study aims to examine:





**Vaishali N. Choudhari**

- Gender difference in positive emotion at work-place
- Gender difference in engagement at work-place
- Gender difference in relationship at work-place
- Gender difference in meaning at work-place
- Gender difference in accomplishment at work-place
- Gender difference in health& loneliness at work-place

#### **Hypotheses**

- There is difference in male and female employees with respect to PERMA (positive emotions, engagement, relationship, meaning, accomplishment & health)
- Male employees are likely to have more positive emotions at workplace as compared to female employees.
- Male employees are likely to have more engagement at workplace as compared to female employees.
- Female employees are likely to have better relationship at workplace as compared to male employees.
- Male employees are likely to have more meaningfulness in work at workplace as compared to female employees.
- Male employees are likely to have more accomplishment at workplace as compared to female employees.
- Female employees are likely to have better health as compared to male employees.

## **RESEARCH METHOD**

#### **Participants**

This investigation included total 86 participants (43 male & 43 female employees) of age range 35 to 55 years ( $M= 45$  yrs). Data were drawn from leading Private University in Maharashtra. They were matched for age, sex, and socio-economic status.

#### **Research Design**

Two group design.

#### **Tool**

For comparative mental health assessment of employees, PERMA profile developed by Margaret L. Kern (2014)<sup>[10]</sup> was used. It measures five pillars, along with negative emotion and health of employees.

P and N = Positive and Negative emotions

Emotions are an important part of our well-being. Emotions can range from very negative to very positive and range from high arousal (e.g., excitement, explosive) to low arousal (e.g., calm, relaxed, sad). For Positive emotion, the PERMA-Profiler measures general tendencies toward feeling contentment and joy.

For Negative emotion, the Profiler measures tendencies toward feeling, sad, anxious, and angry.

E = Engagement

Engagement refers to being absorbed, interested, and involved in an activity or the world itself. Very high levels of engagement are known as a state called "flow", in which you are so completely absorbed in an activity that you lose all sense of time.

R = Relationships

Relationships refer to feeling loved, supported, and valued by others. Having positive relationships with others is an important part of life feeling good and going well. Other people matter!



**Vaishali N. Choudhari**

M = Meaning

Meaning refers to having a sense of purpose in life, a direction where life is going, feeling that life is valuable and worth living, or connecting to something greater than ourselves, such as religious faith, a charity or a personally meaningful goal. Meaning provides a sense that life matters.

A = Accomplishment

Accomplishment can be objective, marked by honours and awards received, but feelings of mastery and achievement is also important. The Profiler measures subjective feelings of accomplishment and staying on top of daily responsibilities. It involves working toward and reaching goals, and feeling able to complete tasks and daily responsibilities.

H = Health

Although not part of the PERMA model itself, physical health and vitality is another important part of wellbeing. The Profiler measures a subjective sense of health – feeling good and healthy each day.

#### **Procedure**

After taking permission of higher authority, PERMA profile was administered on faculties of different departments. Proper instructions were given before starting the profile. Observation was noted down of all participants. Data were tabulated and then subjected to analysis. Data were statistically analysed by using *t*-test.

## **RESULT AND DISCUSSION**

This investigation was aimed to assess mental health dimensions i.e. PERMA (positive emotions, engagement, relationship, meaning, accomplishment & health) among employees with respect to gender. As per the table 1, Positive emotions (P) in male employees ( $M=23.65$ ) are found significantly higher ( $t = 6.519$ ) as compared to female employees ( $M=20.19$ ). Result shows that male employees have more positive emotions than female employees. For negative emotion (N), female employees ( $M=16.98$ ) scored significantly higher ( $t=5.235$ ) as compared to male employees ( $M=11.12$ ) It shows women are having more negative emotions at workplace. A workplace is a social place where all peoples are connected with each other and social is kind of word related with “emotion”, how you feel, react or interact with your colleagues is largely controlled by our feelings or emotions. People find most satisfaction at the workplace if they get along well with other team members or the manager. In pandemic situation, all employees had to work from home. All female employees had to deal with family life as well as professional life at same time. This was a challenging task for working women. In Indian family, it is well-known fact that roles are divided as per the gender. This multitasking way of working affects the mental peace of individual at personal level.

Some studies revealed that emotion represents a critical factor that can explain why gender differences in power in work relationships exist and how they are sustained over time. As we will illustrate, while the effective display of emotion is critical for developing power in work relationships,[11][12][13] gender influences expectations, perceptions, and reactions to emotional displays in ways that prevent women from developing and leveraging power in their work relationships [14][15][16]. The proposed hypothesis that male are likely to have more positive emotions than female at workplace is supported by results.

As per table 1, Engagement in work among female employees ( $M=22.02$ ) are found significantly higher ( $t =3.457$ ) than the male employees ( $M=19.63$ ). It shows female employees are more absorbed, interested, and involved in an activity than male employees though it was difficult to deal with family as well as work life at same time during pandemic. Very high levels of engagement are known as a state called “flow”, in which you are so completely





**Vaishali N. Choudhari**

absorbed in an activity that you lose all sense of time. In one study employee engagement is defined as “a positive, fulfilling, work-related state of mind that can be characterized by vigor, dedication and absorption” where vigor refers to an individual’s willingness to put an extra effort and energy within their work by remaining energetic and developing the inclination to remain focused at the time of difficulty or failure [17].

A comprehensive analysis showed that no crucial, statistically significant gender differences could be identified.[18] However, it was found that women are more loyal to their employer than men, who tend to be more self-confident and independent. Nonetheless, the attitudes of men and women were found to be the same when it comes to engagement. One study investigated gender preferences in employee satisfaction in pharmaceutical companies.[19] He concluded that remuneration - size of the wage and/or additional benefits - is more important to men, whereas equal opportunities in the workplace and freedom to perform their job are more important to women. Some study examined the total rate of employee engagement. They established that women show significantly higher engagement than men [20]. Therefore, the proposed hypothesis that male are likely to have more engagement than female employees at workplace is not supported by result.

As per table 1, R-Relationship dimension in male employees ( $M = 22.70$ ) is significantly higher ( $t = 3.747$ ) as compared to female employees ( $M = 20.53$ ) at workplace. Relationships refer to feeling loved, supported, and valued by others. Having positive relationships with others is an important part of life feeling good and going well at workplace. Result shows that male is having good relationship with workplace colleagues than female employees. Gender is an undeniably critical factor in many aspects of the psychology of work, including the types of jobs and careers that individuals seek and receive their promotions and career paths, and the ways in which individuals are perceived and evaluated as employees and employers. Gender differences in the workplace typically stem from social factors, which influence the behaviours of men and women. Some organizations welcome gender diversity and encourage the inclusion of both sexes when making company decisions and offering promotional opportunities. Other organizations discourage gender inclusion and promote bias in the workplace. With most companies, gender differences add value and varying perspectives to an organization. Gender differences involve many factors including physical as well as psychological in nature. They are essentially the characteristics that influence male and female behavior and their relationship at the workplace. These influences may stem from psychological factors, such as upbringing, or physical factors, such as an employee’s capability to perform job duties. Differences may also stem from gender stereotypes related to men and women. For instance, a stereotypical assessment is that women belong in the home while men work and provide support. Stereotypes often lead to sex discrimination in the workplace.

Some findings revealed that women were significantly more likely than men to describe the benefits of workplace friendship in terms of social and emotional support in times of stress, while men focused mainly on the benefits friends provided them in their career or in functional aspects of ‘getting the job done’.[21] Literature with a focus on interpersonal relationships indicates that men achieve and define closeness through the sharing of activities; women define and achieve closeness through the sharing of feelings and emotions [22][23].

Various studies have indicated gender gap in India. According to a report by Team Lease, more than 72% of women feel gender discrimination is still prevalent at workplace. They attribute the unfairness to privileges men receive both at organizational and societal level, pro men practices, male dominated peer eco-system, and skewed career advancement pathways. In this pandemic situation, female employees had to play both roles simultaneously as a mother, wife in family and as an employee. We got the results that female employees scored less in positive emotion which explains that female employees have problem in maintaining relationship at workplace when compared to male employees. Here, result doesn’t support the hypothesis that female employees are likely to have better relationship as compared to male employees. As per the table 1, M-Meaning dimension in female employee ( $M=25.09$ ) is found significantly higher ( $t=4.250$ ) as compared to male employee ( $M=22.63$ ). Meaning refers to having a sense of purpose in life, a direction where life is going, feeling that life is valuable and worth living, or connecting to something greater than ourselves, such as religious faith, a charity or a personally meaningful goal. Meaning



**Vaishali N. Choudhari**

provides a sense that life matters. The meaningfulness of work plays a significant role in improving an employee's capacity to achieve organizational goals and objectives. Meaningfulness of work can be defined as the positive and significant contributions of the job to one's life, and the satisfaction that an individual derives from their job [24].

Employees prefer to do work which is exciting, challenging, and interesting in nature and that enhances their feelings of self-regard, motivates them to complete the task and provides identity and meaning to their lives [25]. Recent researches in this area reveal that autonomy, involvement, commitment, and satisfaction are recognized as significant factors to achieve meaningfulness of work [26]. It is confirmed a positive relationship between meaningfulness of work, employee engagement, and affective commitment. In this investigation, female employees are found to be more engaged in work at workplace and it is positively correlated with meaningfulness of work [27]. Present result reveals that female employees have more sense of purpose and meaning towards their work at workplace as compared to male employees. Documented studies and result does not support the hypothesis that male employees are likely to have more meaningfulness in work at work-place as compared female employees.

As per table 1, A-Accomplishment sense at work-place is found to be same in male and female employees and a significant difference among gender is not noted. Accomplishment can be objective, marked by honors and awards received, but feelings of mastery and achievement is also important. The Profiler measures subjective feelings of accomplishment and staying on top of daily responsibilities. It involves working toward and reaching goals, and feeling able to complete tasks and daily responsibilities. Though the significant difference has not been observed but still when we compare means, female employees ( $M=24.77$ ) scored higher as compared to male employees ( $M=23.21$ ). Result obtained in first dimensions i.e. engagement and meaning at work-place reveals that female employee are found to be more engaged in work, have more sense of purpose and meaning towards the work at work-place.

In case of Health, Happiness and Loneliness dimension, there is no significant difference observed among male and female employees. In case of health, low scores suggest that individual is not satisfied with their health. Result reveals that all employees are more aware and satisfied about their health factor. In case of happiness, low scores suggest that individual is not happy with their assigned work at work-place. But in this investigation, all employees are seems to be happy with their working condition. In case of loneliness, high scores suggest that individual feels lonely at work-place. But in this study, all employees scored less which reveals that they have a feeling of togetherness at their work-place. Although, these dimensions are not the part of PERMA model itself, physical health, vitality, happiness and feeling of togetherness are another important part of wellbeing. These finding are little bit contradictory in pandemic situation but it assures that employees are able to manage their mental health in crisis condition also.

## CONCLUSION

This investigation concluded with the findings that male and female employees differ in their well-being components i.e. PERMA (positive emotions, engagement, relationship, meaning, accomplishment & health) at work-place. Male employees are found to be better in dimension of positive emotion and relationship at work-place. Female employees are found to be better in dimension of engagement, meaning and accomplishment at work-place. For health and happiness, both (male & female) do not differ. The limitations of the study are the sample size is small and the sample is collected from one of the leading private university.

## ACKNOWLEDGEMENT

This research was supported by the Dean of Social Sciences & Humanities, Dr.RekhaShelke madam and Principal of JNEC (Jawaharlal Nehru Engineering College), Dr.HarirangShinde sir. I would like to thank both as well as their staff for their valuable assistance.





**Vaishali N. Choudhari**

## REFERENCES

1. Chiu M, Amartey A, Wang X, et al. (2020). Trends in objectively measured and perceived mental health and use of mental health services: a population-based study in Ontario, 2002–2014. *CMAJ.*;192(13):E329–E337. 10.1503/cmaj.190603
2. Lai J, Ma S, Wang Y, et al. : Factors Associated With Mental Health Outcomes Among Health Care Workers Exposed to Coronavirus Disease 2019. *JAMA Netw Open.* 2020;3(3):e203976–e203976. 10.1001/jamanetworkopen.2020.3976
3. Perlis RH: Exercising Heart and Head in Managing Coronavirus Disease 2019 in Wuhan. *JAMA Netw Open.* 2020;3(3):e204006–e204006. 10.1001/jamanetworkopen.2020.4006
4. Wu KK, Chan SK, Ma TM: Posttraumatic stress after SARS. *Emerg Infect Dis.* 2005;11(8):1297–1300. 10.3201/eid1108.041083
5. Xiang YT, Yang Y, Li W, et al. : Timely mental health care for the 2019 novel coronavirus outbreak is urgently needed. *Lancet Psychiatry.* 2020;7(3):228–229. 10.1016/S2215-0366(20)30046-8
6. Giorgi G, Lecca LI, Alessio F, Finstad GL, Bondanini G, Lulli LG, Arcangeli G, MucciN. *Int J Environ Res Public Health.* 2020 Oct 27;17(21):7857. doi: 10.3390/ijerph17217857.
7. WHO. (2019). *Mental health in the workplace.* Retrieved from [https://www.who.int/mental\\_health/in\\_the\\_workplace/en/](https://www.who.int/mental_health/in_the_workplace/en/)
8. MacIntyre, CR. (2020). On a knife's edge of a COVID-19 pandemic: is containment still possible? *Public Health Res Pract,*
9. Shigemura, J, Ursano, RJ, & Morganstein, JC. (2020). Public responses to the novel 2019 coronavirus (2019-nCoV) in Japan: mental health consequences and target populations. *Psychiatry ClinNeurosci,* **74**(4), 281– 282.
10. Butler J, Kern ML. The workplace PERMA Profiler: Margaret L. Kern, University of Pennsylvania. (2014); 1–2. Available from: [http://www.peggykern.org/uploads/5/6/6/7/56678211/workplace\\_perma\\_profiler\\_102014.pdf](http://www.peggykern.org/uploads/5/6/6/7/56678211/workplace_perma_profiler_102014.pdf)
11. Gibson, D. E., & Schroeder, S. J. (2002). Grinning, frowning, and emotionless: Agent perceptions of power and their effects on felt and displayed emotions in influence attempts. In N. M. Ashkanasy, W. J. Zerbe, & C. E. J. Hartel (Eds.), *Managing emotions in the workplace* (pp. 184–211). New York: M. E. Sharpe.
12. Hareli, S., & Rafaeli, A. (2008). Emotion cycles: On the social influence of emotion in organizations. *Research in Organizational Behavior,* **28**, 35–59.
13. Tiedens, L. Z., Ellsworth, P. C., & Mesquita, B. (2000). Stereotypes about sentiments and status: Emotional expectations for high- and low-status group members. *Personality and Social Psychology Bulletin,* **26**, 560–574.
14. Fischer, A. H. (Ed.). (2000). *Gender and emotion: Social psychological perspectives.* New York: Cambridge University Press.
15. Johnson, J. T., & Shulman, G. A. (1988). More alike than meets the eye: Perceived gender differences in subjective experience and its display. *Sex Roles,* **19**, 67–79.
16. Shields, S. A. (2000). Thinking about gender, thinking about theory: Gender and emotional experience. In A. H. Fischer (Ed.), *Gender and emotion: Social psychological perspectives* (pp. 3–23). Cambridge, UK: Cambridge University Press.
17. Schaufeli B, Bakker A (2004) Job demands, job resources, and their relationship with burnout and engagement: A multi-sample study. *J Organ Behav;* **25**: 293-315. [<http://dx.doi.org/10.1002/job.248>]
18. Alice Reissová, Jana Šimsová, Kateřina Hášová. (2017). Gender Differences in Employee Engagement. *Littera Scripta,* Volume 10, Issue 2.
19. Mendiratta, A., 2016. Gender Differences in Job Satisfaction - A Study of Pharmaceutical Employees in Jaipur (India). *OPUS: HR Journal* [online]. New Delhi: PublishingIndia, **7**(2), 60-71 [accessed 2017-06-24]. ISSN 0973-9866. Available at: <http://search.ebscohost.com/login.aspx?direct=true&db=bth&an=121478133&scope=site>.
20. Shukla, S., Adhikari, B. & Singh, V. (2015). Employee Engagement - Role of Demographic Variables and Personality Factors. *Amity Global HRM Review* [online]. Noida: Amity International Business School, **5**, 65-73 [accessed 2017-06-24]. ISSN 2250-060X. Available at: <http://search.ebscohost.com/login.aspx?direct=true&db=bth&an=122638894&scope=site>





**Vaishali N. Choudhari**

21. Morrison, R. (2008). Are Women Tending and Befriending in the Workplace? Gender Differences in the Relationship Between Workplace Friendships and Organizational Outcomes. *Sex Roles* · DOI: 10.1007/s11199-008-9513-4 Retrieved from <https://www.researchgate.net/publication/226946849>
22. Odden, C. M., & Sias, P. M. (1997). Peer communication relationships, psychological climate, and gender. *Communication Quarterly*, 45, 153–166.
23. Wood, J. T., & Inman, C. C. (1993). In a different mode: Masculine styles of communicating closeness. *Journal of Applied Communication Research*, 21, 279–295.
24. Mowday T, Porter L, Steers R (1982) Employee-organization linkages: The psychology of commitment, absenteeism, and turnover. New York:Academic press.
25. Bibby R. (2001). Canada’s teens: Today, Yesterday and tomorrow. Toronto: Stoddart
26. Madelyn G, Karolina L, Cornelia V (2014). Meaningful work, work engagement, and organizational commitment. *SA J IndPsychol*; 40(1): 1098-108.
27. Kaur, P. and Mittal, A. (2020). Meaningfulness of Work and Employee Engagement: The Role of Affective Commitment. *The Open Psychology Journal*, DOI: 10.2174/1874350102013010115, 2020, 13, 115-122
28. WORLD ECONOMIC FORUM (2020). COVID-19’s Workforce Impact. [Online]. Geneva: World Economic Forum, Strategic intelligence.

**Table: 1 showing mean, SD and t-value**

Factors	Gender	N	Mean	Standard Deviation	t-value
Positive emotion	F	43	20.19	1.708	6.519*
	M	43	23.65	3.039	
Engagement	F	43	22.02	3.074	3.457*
	M	43	19.63	3.345	
Relationship	F	43	20.53	3.081	3.747*
	M	43	22.70	2.199	
Meaning	F	43	25.09	2.297	4.250*
	M	43	22.63	3.032	
Accomplishment	F	43	24.77	2.608	2.715
	M	43	23.21	2.713	
Health	F	43	22.28	4.992	0.627
	M	43	22.91	4.270	
Negative emotion	F	43	16.98	5.185	5.235*
	M	43	11.12	5.197	
Lonely	F	43	3.88	3.201	2.211
	M	43	2.56	2.281	
Happy	F	43	7.86	1.473	0.143
	M	43	7.91	1.540	

\*p<0.05





Vaishali N. Choudhari

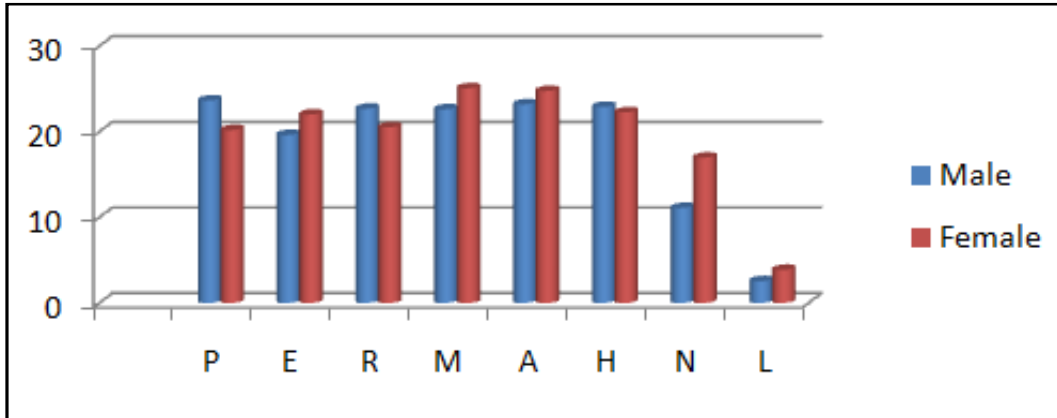


Figure 1: Showing mean differences among male and female employees.





## Phytochemical Screening and GC MS Analysis of Bioactive Compounds of *Barleria cuspidata* Heyne Ex Nees

V.Gomathi<sup>1\*</sup> and B. Jaykar<sup>2</sup>

<sup>1</sup>Professor, Department of Pharmacology, Vinayaka Mission's College of Pharmacy, Yercad Main Road, Salem, Vinayaka Mission's Research Foundation (Deemed to be University), Ariyanur, Salem, Tamil Nadu, India

<sup>2</sup>Registrar, Vinayaka Mission's Research Foundation (Deemed to be University), Ariyanur, Salem, Tamil Nadu, India

Received: 12 Nov 2021

Revised: 21 Dec 2021

Accepted: 11 Jan 2022

### \*Address for Correspondence

#### V.Gomathi

Professor, Department of Pharmacology,  
Vinayaka Mission's College of Pharmacy, Yercad Main Road, Salem,  
Vinayaka Mission's Research Foundation (Deemed to be University),  
Ariyanur, Salem, Tamil Nadu, India.  
Email: gomicology@gmail.com



This is an Open Access Journal / article distributed under the terms of the **Creative Commons Attribution License** (CC BY-NC-ND 3.0) which permits unrestricted use, distribution, and reproduction in any medium, provided the original work is properly cited. All rights reserved.

### ABSTRACT

The Present study was designed to determine the bioactive compounds in the leaf extract of *Barleria cuspidata sheyne ex Nee*. The phytochemical screening of the extract showed the presence of phenolic compounds, alkaloids, carbohydrates, protein, aminoacids, tannins, volatile oils, flavonoids. GC MS analysis of the the leaf extract of *Barleria cuspidata sheyne ex Nee* was carried out. (Thermo Scientific Co.) Thermo GC- TRACE ultra ver: 5.0, Thermo MS DSQ II. The total major phytocompounds were identified with eight different peaks.

**Keywords:** *Barleria cuspidata heyne ex Nee*, GC-MS analysis, ethanolic extract

## INTRODUCTION

*Barleria cuspidata heyne ex Nee* is one of the important species in *Barleria* belongs to the family *Acanthaceae*.<sup>1</sup> The most common vernacular names are spiny *Barleria*, lesser yellow nail dye, vellauimuli,, Sanskrit-kurantaka, kadanculli,. It is a shrub found in waste places, dry plains, rocky hillslopes. . The roots and leaves were used traditionally in stomach ache, tonic, febrifuge, cough, bronchitis and in inflammation.<sup>2</sup> The reported activities of *Barleria cuspidata Heyne ex Nees* are wound healing property<sup>3</sup>, and hepato protective activity acute and sub-chronic toxicity <sup>4</sup> and ant diabetic activity . The aim of the present study was to investigate the phytochemical screening and GC MS analysis of bioactive compounds of *Barleria cuspidata Heyne ex Nees*





## MATERIALS AND METHODS

### Plant material

The leaves *Barleria cuspidate heyne ex Nees* were collected from Yercaud hills in the month of September 2020. The plant has been taxonomically identified and authenticated by the botanist Dr.A. Balasubramanian. The authenticated plants were used for preparation of extracts.

### Extraction

The cleaned and powdered leaves *Barleria cuspidate heyne ex Nees* was used for extraction purpose. 300grams of powdered material was evenly packed in the Soxhlet apparatus [6]. It was then extracted with various solvents from non-polar to polar such as petroleum ether (60 - 80°C, chloroform, acetone and ethanol 90% v/v (75 – 78 ° C) by continuous hot percolation process. Aqueous extraction was done by cold maceration process.

### Preliminary Phytochemical Screening

Preliminary phytochemical screening was carried out on petroleum ether, chloroform, acetone, Ethanol and water extracts of the plant as per standard procedure [7,8]

### Gc-Ms Analysis

Gas chromatography study for the ethanolic extract of *Barleria cuspidata* was executed by employing the Perkin-Elmer Clarus 680 system (Perkin-Elmer, Inc. U.S.A) prepared with a merged silica column, filled with Elite-5MS) capillary-based column. Clean helium gas (99.99%) was utilized like a carrier gaseous at a continuous flowing proportion of 1 ml per minute. For GC–MS spectrum identification, an electron ionization energy technique was assumed with higher ionization energy of 70 eV (electron Volts) with 0.2 sec of scanning time and fragments varying from 40 to 600 m/z. The inoculation amount of 1 µL was employed (split ratio 10:1), and the injection temperature was preserved at 250 °C (constant). The T for the oven column was placed at 50 °C for 3 mins, elevated at 10 °C per mins nearly 280 °C, and final T was enlarged to 300 °C for 10 mins. The contents of phyto-chemicals exist in the testing specimens were recognized depends on assessment of their retention time (min), peak area, height and mass spectrum outlines with those spectrum databases of reliable mixtures deposited in the National Institute of Standards and Technology (NIST) repository. The GC MS chromatogram is shown in Figure 1.

## RESULTS AND DISCUSSION

The ethanolic extract of *Barleria cuspidata* was characterized by employing GC-MS study which depicts the identification of compounds, structure, formula along with its molecular weight. The GC–MS chromatogram of ethanolic extract of *Barleria cuspidata* recorded a total of 8 matched peaks equivalent to the biologically active substances that were documented by involving their peak retention time, peak area, height in percentage and mass spectrum fragmenting forms relates to the existing substances designated by the NIST library. Outcomes exposed that 8 phyto-compounds were recognized in ethanolic extract of *Barleria cuspidata* (Table 1 and Figures 1a to 1h). Overall, the structure of 8 phyto-compounds known in the ethanolic extract of *Barleria cuspidata* is listed in Table 1 along with their peak area in percentage. Methylcyclohexane is a monosubstituted cyclohexane because it has one branching via the attachment of one methyl group on one carbon of the cyclohexane ring [9]. Methyl octanoate is a fatty acid methyl ester resulting from the formal condensation of the carboxy group of octanoic acid with the hydroxyl group of methanol. It has a role as a metabolite. It is a fatty acid methyl ester and an octanoate ester. Methyl octanoate also known as caprylic acid methyl ester is a fatty acid methyl ester resulting from the formal condensation of the carboxy group of octanoic acid with the hydroxyl group of methanol. It has a role as a metabolite. It is a fatty acid methyl ester and an octanoate ester [10,11] Lauric acid increases total serum cholesterol more than many other fatty acids, but mostly high-density lipoprotein (HDL) As a result, lauric



**Gomathi and Jaykar**

acid has been characterized as having a more favourable effect on total HDL cholesterol than any other fatty acid [examined], either saturated or unsaturated [12]. Arabinose moiety has antiviral property [13] 5 $\alpha$ -cholestan-3-one is a 3-oxo-5 $\alpha$ - steroid that is 5 $\alpha$ -cholestane substituted by an oxo group at position 3. It has a role as a mammalian metabolite [14].

**CONCLUSION**

From the results, it could be concluded that the plant *Barleria cuspidata* contains various bioactive compounds have various pharmacological activities. Isolation of individual phytochemical constituents and screening for their bioactivity will give hopeful results. Therefore, it is recommended as a plant of phytopharmaceutical importance.

**ACKNOWLEDGEMENT**

The authors are sincerely thankful to the administration of Vinayaka Missions Research Foundation (Deemed to be University), for giving support to complete the research work. Financial Support The authors declare that they have funding from the VMRF university support for this study.

**CONFLICT OF INTEREST**

The authors declare that there was no conflict of interest in this research.

**REFERENCES**

1. Balkwill, M. J. & Balkwill, K. (1997). Delimitation and infrageneric classification of *Barleria* (Acanthaceae). *Kew Bull.* 52(3): 535-573.
2. Madhavachetty, K., Sivaji, K., Tulasirao, K. Flowering plants of chittoor district Andhra Pradesh, India. Students offset printers, Tirupati.2013;253
3. Mazumder, P. M., Sasmal, D & Choudhary R. K.. Wound Healing Potential of The Leaf Extracts of *Barleria cuspidata* Heyne Ex Nees. *Pharmacologyonline*2009. 1: 357-362.
4. Tabassum, S., S., S., Rajaram, C., Nelson, K., S., Manohar, R & Ravindra R. K. Evaluation of Hepatoprotective activity of the Methanolic Extract of *Barleria Cuspidata* against CCl<sub>4</sub> Induced Liver damage in Experimental Rats, *Research J. Pharm. and Tech.* 13(2): 2020;538-542.
5. Manohar Reddy and Raja Sundararajan. In vitro antioxidant and antidiabetic activities of *Barleria cuspidata* Heyne ex Nee. *Bulletin of Environment, Pharmacology and Life Sciences Bull. Env. Pharmacol. Life Sci.*, 10 [1] r 2020 : 81-92
6. Gopalsatheeskumar, K. 2018. Significant role of soxhlet extraction process in phytochemical research. *Mintage Journal of Pharmaceutical and Medical Sciences*, 7(1):43-47
7. Evans, W. C., Trease, G. E.. *Trease and Evans Pharmacognosy.* Saunders/Elsevier 2009;603..
8. Sofowora, A. 1993. Research on medicinal plants and traditional medicine in Africa. *J Altern Complement Med*, 2(3):365-372
9. M. Larry Campbell. *Cyclohexane in Ullmann's Encyclopedia of Industrial Chemistry*, Wiley-VCH, Weinheim, 2012.
10. Voller, Bernhard; Lines, Emily; "Dose-escalation study of octanoic acid in patients with essential tremor". *Journal of Clinical Investigation.* 126 (4): 1451-1457.
11. Lowell, Soren Y.; Kelley, Richard T. The Effect of Octanoic Acid on Essential Voice Tremor: A Double-Blind, Placebo-Controlled Study: Effect of Octanoic Acid on EVT". *The Laryngoscope.* 129 (8): 1882-1890.
12. Zarifikhosroshahi; Tugba Murathan; Kafkas; Okatan .Variation in volatile and fatty acid contents among *Viburnum opulus* L. Fruits growing different locations. *Scientia Horticulturae.* 2019;264







## Gomathi and Jaykar

13. Mensink RP, Zock PL, Kester AD, Katan MB .Effects of dietary fatty acids and carbohydrates on the ratio of serum total to HDL cholesterol and on serum lipids and apolipoproteins: a meta-analysis of 60 controlled trials" American Journal of Clinical Nutrition. **77** (5): 2003;1146–1155
14. Maria Cuevas, Ampara alegria and Maria Jesus Lagrada ,Determination of Fecal Sterols Following a Diet with and without Plant Sterols. Lipids. . 2017 Oct;52(10):871-884

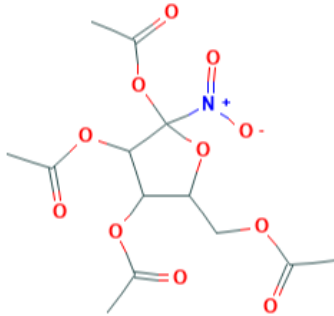
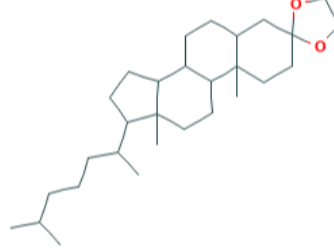

**Table 1. Phyto-compounds present in ethanolic extract of *Barleria cuspidata* using GC-MS Profiling.**

S. No.	CAS	Compound's name	Structure	Molecular formula	M.W	Peak area (%)
1	1461-27-4	Cyclohexene, 1-methyl-5-(1-methylethenyl)-, (R)-		C <sub>10</sub> H <sub>16</sub>	136	93
2	111-11-5	Octanoic acid, methyl ester		C <sub>9</sub> H <sub>18</sub> O <sub>2</sub>	158	74
3	823-19-8	Cyclohexanone, 3-hydroxy		C <sub>6</sub> H <sub>10</sub> O <sub>2</sub>	114	43
4	40259-14-1	Pyrrolidine, 1-methyl-3,2'-spiro-benzo-1,3-dioxolane		C <sub>11</sub> H <sub>13</sub> NO <sub>2</sub>	191	57
5	2874-74-0	Dodecanoic acid, 2-methyl-		C <sub>13</sub> H <sub>26</sub> O <sub>2</sub>	214	74





Gomathi and Jaykar

6	Not Available	1-Nitro-.beta.-d-arabinofuranose, tetraacetate		C <sub>13</sub> H <sub>17</sub> NO <sub>11</sub>	363	43
7	25328-53-4	Cholestan-3-one, cyclic 1,2-ethanediyl aetal, (5.beta.)		C <sub>29</sub> H <sub>50</sub> O <sub>2</sub>	430	99
8	2619-88-7	16-Hexadecanoyl hydrazide		C <sub>16</sub> H <sub>34</sub> N <sub>2</sub> O	270	32

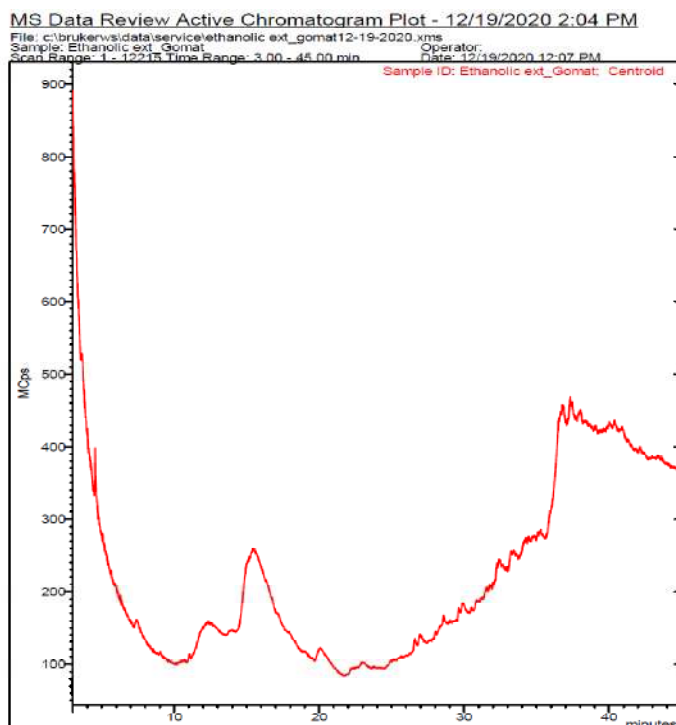


Figure1. GC-MS Chromatogram acquired from the ethanolic extract of *Barleria cuspidata*





## Interval Valued Fuzzy Gradation of Openness

D. Bhavani Gokila<sup>1\*</sup> and V.M.Vijayalakshmi<sup>2</sup>

<sup>1</sup>Research Scholar, Department of Mathematics, Avinashilingam Institute for Home Science and Higher Education for Women, Coimbatore, Tamil Nadu, India

<sup>2</sup>Assistant Professor, Department of Science and Humanities, School of Engineering, Avinashilingam Institute for Home Science and Higher Education for Women, Coimbatore, India

Received: 23 Oct 2021

Revised: 28 Nov 2021

Accepted: 19 Jan 2022

### \*Address for Correspondence

#### D. Bhavani Gokila

Research Scholar,

Department of Mathematics,

Avinashilingam Institute for Home Science and Higher Education for Women,

Coimbatore, Tamil Nadu, India

Email: 19phmaf006@avinuty.ac.in



This is an Open Access Journal / article distributed under the terms of the **Creative Commons Attribution License** (CC BY-NC-ND 3.0) which permits unrestricted use, distribution, and reproduction in any medium, provided the original work is properly cited. All rights reserved.

### ABSTRACT

In this paper interval valued fuzzy gradation of openness and interval valued fuzzy gradation of closedness are introduced and analysed.

**Keywords:** Interval valued fuzzy set, interval valued fuzzy topology, interval valued fuzzy gradation of openness, interval valued fuzzy gradation of closedness

## INTRODUCTION

In 1965, Zadeh introduced the notion of a fuzzy set and in 1975, He extended to interval valued fuzzy set with two membership function. Chang [2] defined the fuzzy topology and obtain some of its properties. Mondal and Samantha [10] defined the interval valued fuzzy topology in the sense of Chang [2]. In 1992, Hazra, et al. [7] introduced the concept of gradation of openness. In this articles [3,4,7], the authors developed a theory on gradation of openness. They associated a Chang fuzzy topology with every gradation of openness and vice versa. Also they introduced the definition of gradation preserving maps. In this paper, the concept of gradation of openness is extended to interval valued fuzzy topological spaces.

### Preliminary Definitions

#### Definition : 2.1 [13]

Let  $I = [0,1]$ . A fuzzy set in  $X$  (arbitrary non empty set) is a mapping from  $X$  into  $I$  that is a fuzzy set is an element of  $I^X$ .





**Bhavani Gokila and Vijayalakshmi**

**Definition: 2.2 [8],[9]**

Let X be a nonempty set. A function  $\widehat{\mu} : X \rightarrow [I]$  is called an **interval valued fuzzy set** in X, where [I] is the set of all closed subintervals of [0, 1].  $[I]^X$  denotes the collection of all interval valued fuzzy sets in X.

For every  $\widehat{\mu} \in [I]^X$  and  $x \in X$ ,  $\widehat{\mu}(x) = [\mu^-(x), \mu^+(x)]$  is called the degree of membership of an element x to  $\widehat{\mu}$ , where  $\mu^- : X \rightarrow I$  and  $\mu^+ : X \rightarrow I$  are called the lower fuzzy set and upper fuzzy set in X respectively,  $\widehat{\mu}$  is denoted as  $\widehat{\mu} = [\mu^-, \mu^+]$ .

For any two interval valued fuzzy sets  $\widehat{\mu}, \widehat{\lambda}$  in  $[I]^X$

- (i)  $\widehat{\mu} \subseteq \widehat{\lambda}$  iff  $\mu^-(x) \leq \lambda^-(x)$  and  $\mu^+(x) \leq \lambda^+(x)$  for every  $x \in X$
- (ii)  $\widehat{\mu} = \widehat{\lambda}$  iff  $\widehat{\mu} \subseteq \widehat{\lambda}$  and  $\widehat{\lambda} \subseteq \widehat{\mu}$ .
- (iii) The **union**  $\widehat{\mu} \cup \widehat{\lambda}$  and **intersection**  $\widehat{\mu} \cap \widehat{\lambda}$  are defined respectively as
 
$$\widehat{\mu} \cup \widehat{\lambda} = [\mu^- \vee \lambda^-, \mu^+ \vee \lambda^+]$$

$$\widehat{\mu} \cap \widehat{\lambda} = [\mu^- \wedge \lambda^-, \mu^+ \wedge \lambda^+]$$
- (iv) The **complement** of  $\widehat{\mu}$ , denoted by  $\widehat{\mu}^c$  is defined  $\widehat{\mu}^c(x) = [1 - \mu^+(x), 1 - \mu^-(x)]$  for every  $x \in X$ .
- (v) For a family  $\{\widehat{\mu}_j / j \in J\}$  of interval valued fuzzy sets on a set X, the **union**  $\bigcup_{j \in J} \widehat{\mu}_j$  and the **intersection**  $\bigcap_{j \in J} \widehat{\mu}_j$  are defined, respectively, as
 
$$\bigcup_{j \in J} \widehat{\mu}_j = [ \bigvee_{j \in J} (\mu_j^-), \bigvee_{j \in J} (\mu_j^+) ]$$

$$\bigcap_{j \in J} \widehat{\mu}_j = [ \bigwedge_{j \in J} (\mu_j^-), \bigwedge_{j \in J} (\mu_j^+) ]$$
- (vi) The constant interval valued fuzzy sets zero and one are denoted as  $\widehat{0}$  and  $\widehat{1}$  which are defined, respectively, by
 
$$\widehat{0} = [0, 0], \widehat{1} = [1, 1]$$

**Definition : 2.3[10]**

Let X be a nonempty set. A subset  $\widehat{\tau} \subset [I]^X$  is called an interval valued fuzzy topology (Chang) on X iff  $\widehat{\tau}$  satisfies the following axioms :

- (i)  $\widehat{0}, \widehat{1} \in \widehat{\tau}$
- (ii)  $\widehat{\mu}, \widehat{\lambda} \in \widehat{\tau}$  implies  $\widehat{\mu} \cap \widehat{\lambda} \in \widehat{\tau}$
- (iii)  $\widehat{\mu}_j \in \widehat{\tau}$  for each  $j \in J$  implies  $(\bigcup_{j \in J} \widehat{\mu}_j) \in \widehat{\tau}$ .

The pair  $(X, \widehat{\tau})$  is called an interval valued fuzzy topological space.

**Definition:2.4 [10]**

Let X and Y be a two non-empty sets. Let  $\theta : X \rightarrow Y$  be a mapping.

- (i) Let  $\widehat{\mu}$  be an interval valued fuzzy set in X. Then the **image of  $\widehat{\mu}$**  under  $\theta$ , denoted by  $\theta(\widehat{\mu}) = [\theta(\mu^-), \theta(\mu^+)]$ , is an interval valued fuzzy set in Y defined as follows :  
For each  $y \in Y$





**Bhavani Gokila and Vijayalakshmi**

$$\begin{aligned}
 (\theta(\mu^-))(y) &= \begin{cases} \bigvee_{x \in \theta^{-1}(y)} \mu^-(x), & \text{if } \theta^{-1}(y) \neq \phi \\ 0, & \text{otherwise} \end{cases} \\
 (\theta(\mu^+))(y) &= \begin{cases} \bigvee_{x \in \theta^{-1}(y)} \mu^+(x), & \text{if } \theta^{-1}(y) \neq \phi \\ 0, & \text{otherwise} \end{cases}
 \end{aligned}$$

(ii) Let  $\widehat{\lambda}$  be an interval valued fuzzy set in Y. Then the inverse image of  $\widehat{\lambda}$  under  $\theta$ , written as  $\theta^{-1}(\widehat{\lambda}) = [\theta^{-1}(\lambda^-), \theta^{-1}(\lambda^+)]$  is an interval valued fuzzy set in X defined as follows :

For each  $x \in X$

$$\begin{aligned}
 (\theta^{-1}(\lambda^-))(x) &= \lambda^-(\theta(x)) \text{ and} \\
 (\theta^{-1}(\lambda^+))(x) &= \lambda^+(\theta(x))
 \end{aligned}$$

**Definition:2.5[10]**

Let  $(X, \widehat{\tau}_1)$  and  $(Y, \widehat{\tau}_2)$  be two interval valued fuzzy topological spaces. A mapping  $\theta : X \rightarrow Y$  is called an interval valued fuzzy continuous if for all  $\widehat{\mu} \in \widehat{\tau}_2, \theta^{-1}(\widehat{\mu}) \in \widehat{\tau}_1$ .

**Definition:2.6[3]**

Let X be a non empty set. A mapping  $G : I^X \rightarrow I$  is said to be a gradation of openness on X iff the following conditions are satisfied :

- (G<sub>1</sub>)  $G(0) = G(1) = 1$
- (G<sub>2</sub>)  $G(\mu_i) > 0$  for  $i = 1$  to  $m \Rightarrow G(\bigwedge_{i=1}^m \mu_i) > 0$
- (G<sub>3</sub>)  $G(\mu_i) > 0$  for  $j \in J \Rightarrow G(\bigvee_{j \in J} \mu_j) > 0$

The pair  $(X, G)$  is called a gradation space.

**Interval valued fuzzy Gradation of openness**

**Definition :3.1**

Let X be a nonempty set. A mapping  $\widehat{G} : IVF(X) \rightarrow I$  is said to be **interval valued fuzzy gradation of openness** on X, iff the following axioms are satisfied :

- (IVF GO1)  $\widehat{G}(\widehat{0}) = \widehat{G}(\widehat{1}) = 1$
- (IVF GO2)  $\widehat{G}(\widehat{\mu}_i) > 0$ , for  $i = 1$  to  $m$   
 $\Rightarrow \widehat{G}(\bigwedge_{i=1}^m \widehat{\mu}_i) > 0$
- (IVF GO3)  $\widehat{G}(\widehat{\mu}_j) > 0$ , for all  $j \in J$   
 $\Rightarrow \widehat{G}(\bigcirc_{j \in J} \widehat{\mu}_j) > 0$

Therefore  $(X, \widehat{G})$  is called an interval valued fuzzy gradation space.

**Definition :3.2**

Let X be a nonempty set. A mapping  $F : IVG(X) \rightarrow I$  is said to be interval valued fuzzy gradation of closedness on X, iff the following conditions are satisfied :

- (IVF GC1)  $\widehat{F}(\widehat{0}) = \widehat{F}(\widehat{1}) = 1$





**Bhavani Gokila and Vijayalakshmi**

(IVF GC2)  $\widehat{F}(\widehat{\mu}_j) > 0$ , for all  $j \in J$

$\Rightarrow \widehat{F}(\bigcap_{j \in J} \widehat{\mu}_j) > 0$

(IVF GC3)  $\widehat{F}(\widehat{\mu}_i) > 0$ , for  $i = 1$  to  $m$

$\Rightarrow \widehat{F}(\bigcirc_{i=1}^m \widehat{\mu}_i) > 0$

**Definition :3.3**

Let  $(X, \widehat{G})$  be an interval valued fuzzy gradation space. Then the interval valued fuzzy topology on  $X$  induced by  $\widehat{G}$  is given by  $\widehat{\tau}(\widehat{G}) = \{\widehat{\mu} \in \text{IVF}(X) / \widehat{G}(\widehat{\mu}) > 0\}$ .

**Definition :3.4**

Let  $\widehat{G}_1$  and  $\widehat{G}_2$  be two interval valued fuzzy gradation of openness on  $X$ . Then  $\widehat{G}_1 \geq \widehat{G}_2$  if  $\widehat{G}_1(\widehat{\mu}) \geq \widehat{G}_2(\widehat{\mu})$ , for all  $\widehat{\mu} \in \text{IVF}(X)$ .

**Definition :3.5**

Let  $(X, \widehat{G})$  be an interval valued fuzzy gradation space and  $\widehat{\mu} \in \text{IVF}(X)$ . Then  $\widehat{G}$ -closure of  $\widehat{\mu}$ , defined by  $\widehat{G} \text{ cl}(\widehat{\mu}) = \bigcap \{\widehat{\lambda} \in \text{IVF}(X) / \widehat{F}_{\widehat{G}}(\widehat{\lambda}) > 0, \widehat{\lambda} \supseteq \widehat{\mu}\}$

**Note :3.6**

(i)  $\widehat{F}_{\widehat{G}} \widehat{G} \text{ cl}(\widehat{\mu}) > 0$  and

(ii) For every  $\widehat{\mu}, \widehat{\lambda} \in \text{IVF}(X)$ ,  $\widehat{\mu} \supseteq \widehat{\lambda}$  implies that  $\widehat{G} \text{ cl}(\widehat{\mu}) \geq \widehat{G} \text{ cl}(\widehat{\lambda})$ .

**Definition :3.7**

Let  $(X, \widehat{G}_1), (Y, \widehat{G}_2)$  be two interval valued fuzzy gradation spaces. Then a map  $\theta : X \rightarrow Y$  is called

(i) **an interval valued fuzzy gradation preserving map**, if

$(\widehat{G}_2)(\widehat{\mu}) \leq (\widehat{G}_1)(\theta^{-1}(\widehat{\mu}))$ , for each  $\widehat{\mu} \in \text{IVF}(Y)$ .

(ii) **an interval valued fuzzy strongly gradation preserving map**, if

$\widehat{G}_2(\widehat{\mu}) = (\widehat{G}_1)(\theta^{-1}(\widehat{\mu}))$ , for each  $\widehat{\mu} \in \text{IVF}(Y)$ .

(iii) **an interval valued fuzzy weakly gradation preserving map**, if

$(\widehat{G}_2)(\widehat{\mu}) > 0 \Rightarrow (\widehat{G}_1)(\theta^{-1}(\widehat{\mu})) > 0$ , for each  $\widehat{\mu} \in \text{IVF}(Y)$ .

**Definition :3.8**

Let  $X$  be a non empty set. A mapping  $G_* : 2^X \rightarrow I$  is said to be **crisp gradation of openness** on  $X$ , iff the following conditions are satisfied :

(i)  $G_*(\phi) = G_*(X) = 1$

(ii)  $G_*(\mu_i) < 0$ , for  $i = 1$  to  $m$

$\Rightarrow G_*(\bigcap_{i=1}^m \mu_i) > 0$





**Bhavani Gokila and Vijayalakshmi**

$$(iii) \quad G_*(\mu_j) > 0, \text{ for } j \in J \\ \Rightarrow G_*(\bigcup_{j \in J} \mu_j) > 0$$

Therefore  $(X, G_*)$  is a **crisp gradation space**". Then the topology on  $X$  induced by  $G_*$  is  $\tau(G_*) = \{\mu \in 2^X / G_*(\mu) > 0\}$ .

**Definition :3.9**

Given  $\mu = 2^X$  define  $\hat{\mu} = [\mu^-, \mu^+]$  as  $\mu^- : X \rightarrow I$  such that  $\mu^-(x) > 0$ , if  $x \in \mu$  and  $\mu^-(x) = 0$  if  $x \notin \mu$ .  $\mu^+ : X \rightarrow I$  such that  $\mu^+(x) > 0$ , if  $x \in \mu$  and  $\mu^+(x) = 0$  if  $x \notin \mu$ . Therefore  $\hat{\mu} \in \text{IVF}(X)$ .

**Theorem :3.10**

Let  $\hat{G}$  be an interval valued fuzzy gradation of openness on  $X$  and "

$\hat{F}_{\hat{G}} : \text{IVF}(X) \rightarrow I$  be a mapping defined by  $\hat{F}_{\hat{G}}(\hat{\mu}) = \hat{G}(\hat{\mu}^c)$ . Then  $\hat{F}_{\hat{G}}$  is an interval valued fuzzy gradation of closedness on  $X$ .

**Proof :**

Let  $\hat{G}$  be an interval valued fuzzy gradation of openness on  $X$ .

To prove :  $\hat{F}_{\hat{G}}$  is an interval valued fuzzy gradation of closedness on  $X$ .

$$(i) \quad \hat{F}_{\hat{G}}(\hat{0}) = \hat{G}(\hat{0}^c) = \hat{G}(\hat{1}) = 1 \text{ (by IVF GO1)}$$

$$\hat{F}_{\hat{G}}(\hat{1}) = \hat{G}(\hat{1}^c) = \hat{G}(\hat{0}) = 1 \text{ (by IVF GO1)}$$

$$(ii) \quad \hat{F}_{\hat{G}}(\bigcirc_{i=1}^m \hat{\mu}_i) = \hat{G}(\bigcirc_{i=1}^m \hat{\mu}_i)^c \\ = \hat{G}(\bigcap_{i=1}^m (\hat{\mu}_i)^c) > 0 \text{ (by (IVF G02))}$$

$$\Rightarrow \hat{F}_{\hat{G}}(\bigcirc_{i=1}^m \hat{\mu}_i) > 0$$

$$(iii) \quad \hat{F}_{\hat{G}}(\bigcap_{j \in J} \hat{\mu}_j) = \hat{G}(\bigcap_{j \in J} \hat{\mu}_j)^c \\ = \hat{G}(\bigcirc_{j \in J} (\hat{\mu}_j)^c) > 0 \text{ by (IVF GO3)}$$

$$\Rightarrow \hat{F}_{\hat{G}}(\bigcap_{j \in J} \hat{\mu}_j) > 0$$

Therefore  $\hat{F}_{\hat{G}}$  is an interval valued fuzzy gradation of closedness on  $X$ .

**Theorem :3.11**

Let  $\hat{F}$  be an interval valued fuzzy gradation of closedness on  $X$  and

$\hat{G}_{\hat{F}} : \text{IVF}(X) \rightarrow I$  be a mapping defined by  $\hat{G}_{\hat{F}}(\hat{\mu}) = \hat{F}(\hat{\mu}^c)$ . Then  $\hat{G}_{\hat{F}}$  is an interval valued fuzzy gradation of openness on  $X$ .

**Proof :**

Let  $\hat{F}$  be an interval valued fuzzy gradation of closedness on  $X$ .





**Bhavani Gokila and Vijayalakshmi**

To prove:  $\widehat{\mathbf{G}}_{\widehat{\mathbf{F}}}$  is an interval valued fuzzy gradation of openness on X.

(i)  $\widehat{\mathbf{G}}_{\widehat{\mathbf{F}}}(\widehat{\mathbf{0}}) = \widehat{\mathbf{F}}(\widehat{\mathbf{0}}^c) = \widehat{\mathbf{F}}(\widehat{\mathbf{1}}) = 1$  (by IVF GC1)

$\widehat{\mathbf{G}}_{\widehat{\mathbf{F}}}(\widehat{\mathbf{1}}) = \widehat{\mathbf{F}}(\widehat{\mathbf{1}}^c) = \widehat{\mathbf{F}}(\widehat{\mathbf{0}}) = 1$  (by IVF GC1)

(ii)  $\widehat{\mathbf{G}}_{\widehat{\mathbf{F}}}(\bigcap_{i=1}^m \widehat{\mu}_i) = \widehat{\mathbf{F}}(\bigcap_{i=1}^m \widehat{\mu}_i)^c$   
 $= \widehat{\mathbf{F}}((\bigcup_{i=1}^m (\widehat{\mu}_i)^c) > 0$  (by IVF GC2)

$\Rightarrow \widehat{\mathbf{G}}_{\widehat{\mathbf{F}}}(\bigcap_{i=1}^m (\widehat{\mu}_i)) > 0$

(iii)  $\widehat{\mathbf{G}}_{\widehat{\mathbf{F}}}(\bigcup_{j \in J} \widehat{\mu}_j) = \widehat{\mathbf{F}}(\bigcup_{j \in J} \widehat{\mu}_j)^c$   
 $= \widehat{\mathbf{F}}(\bigcap_{j \in J} (\widehat{\mu}_j)^c) > 0$  by (IVF GC3))

$\Rightarrow \widehat{\mathbf{G}}_{\widehat{\mathbf{F}}}(\bigcup_{j \in J} \widehat{\mu}_j) > 0$

Therefore  $\widehat{\mathbf{G}}_{\widehat{\mathbf{F}}}$  is an interval valued fuzzy gradation of openness on X.

**Remark :3.12**

Let  $\widehat{\mathbf{G}}$  be an interval valued fuzzy gradation of openness on X and  $\widehat{\mathbf{F}}$  be an interval valued fuzzy gradation of closedness on X. Then

(i)  $\widehat{\mathbf{G}}_{\widehat{\mathbf{F}}_{\widehat{\mathbf{G}}}} = \widehat{\mathbf{G}}$

(ii)  $\widehat{\mathbf{F}}_{\widehat{\mathbf{G}}_{\widehat{\mathbf{F}}}} = \widehat{\mathbf{F}}$

**Theorem :3.13**

Let  $(X, \widehat{\mathbf{G}})$  be an interval valued fuzzy gradation space. Then

(i)  $\widehat{\mathbf{G}} \text{ cl}(\widehat{\mathbf{0}}) = \widehat{\mathbf{0}}$

(ii)  $\widehat{\mathbf{G}} \text{ cl}(\widehat{\mu}) \supseteq \widehat{\mu}$

(iii)  $\widehat{\mathbf{G}} \text{ cl}(\widehat{\mu}_1 \cup \widehat{\mu}_2) = \widehat{\mathbf{G}} \text{ cl}(\widehat{\mu}_1) \cup \widehat{\mathbf{G}} \text{ cl}(\widehat{\mu}_2)$

(iv)  $\widehat{\mathbf{G}} \text{ cl}(\widehat{\mathbf{G}} \text{ cl}(\widehat{\mu})) = \widehat{\mathbf{G}} \text{ cl}(\widehat{\mu})$

**Proof :**

Proofs of (i) and (ii) are obvious.

To prove (iii)

Let  $\widehat{\mu}_1$  and  $\widehat{\mu}_2 \in \text{IVF}(X)$ , from (ii)  $\widehat{\mathbf{G}} \text{ cl}(\widehat{\mu}_1) \supseteq \widehat{\mu}_1$  and  $\widehat{\mathbf{G}} \text{ cl}(\widehat{\mu}_2) \supseteq \widehat{\mu}_2$   
 $\Rightarrow \widehat{\mathbf{G}} \text{ cl}(\widehat{\mu}_1) \cup \widehat{\mathbf{G}} \text{ cl}(\widehat{\mu}_2) \supseteq \widehat{\mu}_1 \cup \widehat{\mu}_2.$







**Bhavani Gokila and Vijayalakshmi**

From the definition of  $\widehat{\mathbf{G}}$ -closure of  $\widehat{\mu}$   $\widehat{\mathbf{F}}_{\widehat{\mathbf{G}}}(\widehat{\mu}_i) > 0$ , for  $i = 1$  to  $2$

$$\Rightarrow \widehat{\mathbf{F}}_{\widehat{\mathbf{G}}}(\widehat{\mathbf{G}}\text{cl}(\widehat{\mu}_1) \cup \widehat{\mathbf{G}}\text{cl}(\widehat{\mu}_2)) > 0$$

Since  $\widehat{\mathbf{F}}_{\widehat{\mathbf{G}}}(\widehat{\mathbf{G}}\text{cl}(\widehat{\mu}_1) \cup \widehat{\mathbf{G}}\text{cl}(\widehat{\mu}_2)) > 0$  and  $\widehat{\mathbf{G}}\text{cl}(\widehat{\mu}_1) \cup \widehat{\mathbf{G}}\text{cl}(\widehat{\mu}_2) \supseteq \widehat{\mu}_1 \cup \widehat{\mu}_2$ .

$$\text{Then } \widehat{\mathbf{G}}\text{cl}(\widehat{\mu}_1) \cup \widehat{\mathbf{G}}\text{cl}(\widehat{\mu}_2) \supseteq \widehat{\mathbf{G}}\text{cl}(\widehat{\mu}_1 \cup \widehat{\mu}_2) \tag{1}$$

Now to prove  $\widehat{\mathbf{G}}\text{cl}(\widehat{\mu}_1 \cup \widehat{\mu}_2) \supseteq \widehat{\mathbf{G}}\text{cl}(\widehat{\mu}_1) \cup \widehat{\mathbf{G}}\text{cl}(\widehat{\mu}_2)$

We know that  $\widehat{\mu}_1 \subseteq \widehat{\mu}_1 \cup \widehat{\mu}_2$

$$\widehat{\mu}_2 \subseteq \widehat{\mu}_1 \cup \widehat{\mu}_2$$

$$\Rightarrow \widehat{\mathbf{G}}\text{cl}(\widehat{\mu}_1) \subseteq \widehat{\mathbf{G}}\text{cl}(\widehat{\mu}_1 \cup \widehat{\mu}_2) \text{ and}$$

$$\widehat{\mathbf{G}}\text{cl}(\widehat{\mu}_2) \subseteq \widehat{\mathbf{G}}\text{cl}(\widehat{\mu}_1 \cup \widehat{\mu}_2)$$

$$\Rightarrow \widehat{\mathbf{G}}\text{cl}(\widehat{\mu}_1) \cup \widehat{\mathbf{G}}\text{cl}(\widehat{\mu}_2) \subseteq \widehat{\mathbf{G}}\text{cl}(\widehat{\mu}_1 \cup \widehat{\mu}_2)$$

$$\Rightarrow \widehat{\mathbf{G}}\text{cl}(\widehat{\mu}_1 \cup \widehat{\mu}_2) \supseteq \widehat{\mathbf{G}}\text{cl}(\widehat{\mu}_1) \cup \widehat{\mathbf{G}}\text{cl}(\widehat{\mu}_2) \tag{2}$$

From (1) and (2)

$$\widehat{\mathbf{G}}\text{cl}(\widehat{\mu}_1 \cup \widehat{\mu}_2) = \widehat{\mathbf{G}}\text{cl}(\widehat{\mu}_1) \cup \widehat{\mathbf{G}}\text{cl}(\widehat{\mu}_2)$$

Proof of (iv) is obvious.

**Theorem :3.14**

Let  $(X, \widehat{\mathbf{G}})$  be an interval valued fuzzy gradation space. Then for each

$$\widehat{\mu} \in \text{IVF}(X), \widehat{\mathbf{F}}_{\widehat{\mathbf{G}}}(\widehat{\mu}) > 0 \text{ iff } \widehat{\mu} = \widehat{\mathbf{G}}\text{cl}(\widehat{\mu}).$$

**Proof :**

Let  $(X, \widehat{\mathbf{G}})$  be an interval valued fuzzy gradation space.

Assume,  $\widehat{\mathbf{F}}_{\widehat{\mathbf{G}}}(\widehat{\mu}) > 0$ , for each  $\widehat{\mu} \in \text{IVF}(X)$ .

To prove :  $\widehat{\mu} = \widehat{\mathbf{G}}\text{cl}(\widehat{\mu})$ .

$$\begin{aligned} \widehat{\mathbf{G}}\text{cl}(\widehat{\mu}) &= \bigcap \{ \widehat{\lambda} \in \text{IVF}(X) / \widehat{\mathbf{F}}_{\widehat{\mathbf{G}}}(\widehat{\lambda}) > 0, \widehat{\lambda} \supseteq \widehat{\mu} \} \\ &= \widehat{\mu} \end{aligned}$$

(Since  $\widehat{\mathbf{F}}_{\widehat{\mathbf{G}}}(\widehat{\mu}) > 0$ , then  $\widehat{\mu}$  is a member of above collections and also every member contains  $\widehat{\mu}$ ).

Therefore  $\widehat{\mu} = \widehat{\mathbf{G}}\text{cl}(\widehat{\mu})$ .

Conversely, assume  $\widehat{\mu} = \widehat{\mathbf{G}}\text{cl}(\widehat{\mu})$ .

To prove :  $\widehat{\mathbf{F}}_{\widehat{\mathbf{G}}}(\widehat{\mu}) > 0$

By the definition  $\widehat{\mathbf{G}}$  closure of  $\widehat{\mu}$

$$\widehat{\mathbf{G}}\text{cl}(\widehat{\mu}) = \bigcap \{ \widehat{\lambda} \in \text{IVF}(X) / \widehat{\mathbf{F}}_{\widehat{\mathbf{G}}}(\widehat{\lambda}) > 0, \widehat{\lambda} \supseteq \widehat{\mu} \} \text{ Since } \widehat{\mathbf{G}}\text{cl}(\widehat{\mu}) \supseteq \widehat{\mu}, \text{ it is clear that } \widehat{\mathbf{F}}_{\widehat{\mathbf{G}}}(\widehat{\mathbf{G}}\text{cl}(\widehat{\mu})) > 0$$

$$\Rightarrow \widehat{\mathbf{F}}_{\widehat{\mathbf{G}}}(\widehat{\mu}) > 0$$





**Bhavani Gokila and Vijayalakshmi**

**Theorem :3.15**

Let  $\{\widehat{G}_k, k = 1, 2, \dots, n\}$  be a finite family of interval valued fuzzy gradation of openness on X. Then  $\widehat{G} = \bigcap_{k=1}^n \widehat{G}_k$  is an interval valued fuzzy gradation of openness on X.

**Proof :**

Let  $\{\widehat{G}_k, k = 1, 2, \dots, n\}$  be a finite family of interval valued fuzzy gradation of openness on X. Let  $\widehat{G} = \bigcap_{k=1}^n \widehat{G}_k$ .

To prove:  $\widehat{G} = \bigcap_{k=1}^n \widehat{G}_k$  is an interval valued fuzzy gradation of openness on X.

$$\begin{aligned}
 \text{(i)} \quad \widehat{G}(\widehat{0}) &= \left(\bigcap_{k=1}^n \widehat{G}_k\right)(\widehat{0}) \\
 &= \bigwedge_{k=1}^n (\widehat{G}_k(\widehat{0})) \\
 &= \widehat{G}_1(\widehat{0}) \wedge \widehat{G}_2(\widehat{0}) \wedge \widehat{G}_3(\widehat{0}) \wedge \dots \wedge \widehat{G}_n(\widehat{0}) \\
 &= 1 \text{ (since for each } \widehat{G}_k, k = 1, 2, \dots, n \text{ is an IVF GO1)}
 \end{aligned}$$

$$\begin{aligned}
 \widehat{G}(\widehat{1}) &= \left(\bigcap_{k=1}^n \widehat{G}_k\right)(\widehat{1}) = \bigwedge_{k=1}^n (\widehat{G}_k(\widehat{1})) \\
 &= \widehat{G}_1(\widehat{1}) \wedge \widehat{G}_2(\widehat{1}) \wedge \widehat{G}_3(\widehat{1}) \wedge \dots \wedge \widehat{G}_n(\widehat{1}) \\
 &= 1 \text{ (since for each } k = 1, 2, \dots, n \text{ satisfies the condition IVF GO1)}
 \end{aligned}$$

$$\begin{aligned}
 \text{(ii)} \quad \widehat{G}(\widehat{\mu}_i) &= \left(\bigcap_{k=1}^n \widehat{G}_k\right)(\widehat{\mu}_i), \text{ for } i = 1 \text{ to } m \\
 &= \bigwedge_{k=1}^n (\widehat{G}_k(\widehat{\mu}_i)) \\
 &= \widehat{G}_1(\widehat{\mu}_i) \wedge \widehat{G}_2(\widehat{\mu}_i) \wedge \dots \wedge \widehat{G}_n(\widehat{\mu}_i) > 0, \text{ for } i = 1 \text{ to } m \\
 &\Rightarrow \widehat{G}(\widehat{\mu}_i) > 0 \text{ (since for each } \widehat{G}_k(\widehat{\mu}_i) > 0, \text{ for } i = 1 \text{ to } m)
 \end{aligned}$$

$$\begin{aligned}
 \Rightarrow \widehat{G}\left(\bigcap_{i=1}^m \widehat{\mu}_i\right) &= \left(\bigcap_{k=1}^n \widehat{G}_k\right)\left(\bigcap_{i=1}^m \widehat{\mu}_i\right) \\
 &= \bigwedge_{k=1}^n \left(\widehat{G}_k\left(\bigcap_{i=1}^m \widehat{\mu}_i\right)\right) \\
 &= \widehat{G}_1\left(\bigcap_{i=1}^m \widehat{\mu}_i\right) \wedge \widehat{G}_2\left(\bigcap_{i=1}^m \widehat{\mu}_i\right) \wedge \dots \wedge \widehat{G}_n\left(\bigcap_{i=1}^m \widehat{\mu}_i\right) > 0
 \end{aligned}$$

(since for each  $\widehat{G}_k\left(\bigcap_{i=1}^m \widehat{\mu}_i\right) > 0, k = 1, 2, \dots, n$ )

$$\Rightarrow \widehat{G}\left(\bigcap_{i=1}^m \widehat{\mu}_i\right) > 0$$





**Bhavani Gokila and Vijayalakshmi**

$$\begin{aligned}
 \text{(iii)} \quad \widehat{\mathbf{G}}(\widehat{\mu}_j) &= \left( \bigcap_{k=1}^n \widehat{\mathbf{G}}_k \right) (\widehat{\mu}_j), \text{ for all } j \in J \\
 &= \bigwedge_{k=1}^n (\widehat{\mathbf{G}}_k(\widehat{\mu}_j)), \text{ for all } j \in J \\
 &= \widehat{\mathbf{G}}_1(\widehat{\mu}_j) \wedge \widehat{\mathbf{G}}_2(\widehat{\mu}_j) \wedge \dots \wedge \widehat{\mathbf{G}}_n(\widehat{\mu}_j) > 0, \text{ for all } j \in J \\
 &\Rightarrow \widehat{\mathbf{G}}(\widehat{\mu}_j) > 0 \quad (\text{since for each } \widehat{\mathbf{G}}_k(\widehat{\mu}_j) > 0, \text{ for all } j \in J) \\
 \\
 \Rightarrow \widehat{\mathbf{G}}\left(\bigcup_{j \in J} (\widehat{\mu}_j)\right) &= \left( \bigcap_{k=1}^n \widehat{\mathbf{G}}_k \right) \left( \bigcup_{j \in J} (\widehat{\mu}_j) \right) \\
 &= \bigwedge_{k=1}^n (\widehat{\mathbf{G}}_k(\bigcup_{j \in J} (\widehat{\mu}_j))) \\
 &= \widehat{\mathbf{G}}_1(\bigcup_{j \in J} (\widehat{\mu}_j)) \wedge \widehat{\mathbf{G}}_2(\bigcup_{j \in J} (\widehat{\mu}_j)) \wedge \dots \wedge (\widehat{\mathbf{G}}_n(\bigcup_{j \in J} (\widehat{\mu}_j))) > 0, \\
 &\hspace{15em} k = 1, 2, \dots, n \\
 \\
 \Rightarrow \widehat{\mathbf{G}}\left(\bigcup_{j \in J} (\widehat{\mu}_j)\right) &> 0 \quad (\text{since for each } \widehat{\mathbf{G}}_k(\bigcup_{j \in J} (\widehat{\mu}_j)) > 0, k = 1, 2, \dots, n)
 \end{aligned}$$

Therefore  $\widehat{\mathbf{G}} = \bigcap_{k=1}^n \widehat{\mathbf{G}}_k$  is an interval valued fuzzy gradation of openness on X.

**Theorem :3.16**

Let  $(X, \widehat{\mathbf{G}}_1), (Y, \widehat{\mathbf{G}}_2)$  be two interval valued fuzzy topological spaces and  $\theta : X \rightarrow Y$  be a function. Then the following conditions are equivalent .

- (i)  $\theta$  is an interval valued fuzzy weakly gradation preserving map
- (ii)  $\theta(\widehat{\mathbf{G}} \text{ cl}(\widehat{\mu})) \leq \widehat{\mathbf{G}} \text{ cl}(\theta(\widehat{\mu}))$ , for all  $\widehat{\mu} \in \text{IVF}(X)$ .

**Proof :**

Let  $(X, \widehat{\mathbf{G}}_1), (Y, \widehat{\mathbf{G}}_2)$  be two interval valued fuzzy topological spaces and  $\theta : X \rightarrow Y$  be a function.

To prove : (i)  $\Rightarrow$  (ii)

Let us assume that (i) holds, that is  $\widehat{\mathbf{G}}_2(\widehat{\mu}) > 0 \Rightarrow \widehat{\mathbf{G}}_1(\theta^{-1}(\widehat{\mu})) > 0$ , for each  $\widehat{\mu} \in \text{IVF}(X)$ .

Then for each  $\widehat{\mu} \in \text{IVF}(X)$ .

$$\begin{aligned}
 \theta^{-1}(\widehat{\mathbf{G}} \text{ cl}(\theta(\widehat{\mu}))) &= \theta^{-1}[\widehat{\cap} \{ \widehat{\lambda} \in \text{IVF}(Y) : \widehat{\mathbf{F}}_{\widehat{\mathbf{G}}_2}(\widehat{\lambda}) > 0 \text{ and } \widehat{\lambda} \supseteq \theta(\widehat{\mu}) \}] \\
 &= \theta^{-1}[\widehat{\cap} \{ \widehat{\lambda} \in \text{IVF}(Y) : \widehat{\mathbf{F}}_{\widehat{\mathbf{G}}_1}(\theta^{-1}(\widehat{\lambda})) > 0 \text{ and } \widehat{\lambda} \supseteq \theta(\widehat{\mu}) \}] \\
 &\geq \widehat{\cap} \{ \theta^{-1}(\widehat{\lambda}) \in \text{IVF}(X) : \widehat{\mathbf{F}}_{\widehat{\mathbf{G}}}(\theta^{-1}(\widehat{\lambda})) > 0, \theta^{-1}(\widehat{\lambda}) \supseteq \theta^{-1}(\theta(\widehat{\mu})) = \widehat{\mu} \} \\
 &\geq \widehat{\cap} \{ \widehat{\gamma} \in \text{IVF}(X) : \widehat{\mathbf{F}}_{\widehat{\mathbf{G}}_1}(\widehat{\gamma}) > 0, \widehat{\gamma} \supseteq \widehat{\mu} \} \\
 &\geq \widehat{\mathbf{G}} \text{ cl}(\widehat{\mu}) \\
 &\Rightarrow \theta^{-1}(\widehat{\mathbf{G}} \text{ cl}(\theta(\widehat{\mu}))) \geq \widehat{\mathbf{G}} \text{ cl}(\widehat{\mu})
 \end{aligned}$$





**Bhavani Gokila and Vijayalakshmi**

$$\Rightarrow \widehat{\mathbf{G}} \text{ cl}(\theta(\widehat{\mu})) \geq \theta(\widehat{\mathbf{G}} \text{ cl}(\theta(\widehat{\mu})))$$

$$\Rightarrow \theta(\widehat{\mathbf{G}} \text{ cl}(\theta(\widehat{\mu}))) \leq \widehat{\mathbf{G}} \text{ cl}(\theta(\widehat{\mu})), \text{ for all } \widehat{\mu} \in \text{IVF}(X)$$

Therefore (i)  $\Rightarrow$  (ii)

To prove : (ii)  $\Rightarrow$  (i)

Let us assume (ii) holds, that is  $\theta(\widehat{\mathbf{G}} \text{ cl}(\theta(\widehat{\mu}))) \leq \widehat{\mathbf{G}} \text{ cl}(\theta(\widehat{\mu})),$  for all  $\widehat{\mu} \in \text{IVF}(X)$  for each  $\widehat{\lambda} \in \text{IVF}(Y).$

$$\widehat{\mathbf{G}}_2(\widehat{\lambda}) > 0 \Rightarrow \widehat{\mathbf{F}}_{\widehat{\mathbf{G}}_2}(\widehat{\lambda}^c) > 0 \text{ iff } (\widehat{\mathbf{G}}_2 \text{ cl}(\widehat{\lambda}^c)) = (\widehat{\lambda}^c)$$

$$\text{Since } \theta(\widehat{\mathbf{G}} \text{ cl}(\theta^{-1}(\widehat{\lambda}^c))) \subseteq \widehat{\mathbf{G}} \text{ cl}(\theta(\theta^{-1}(\widehat{\lambda}^c))) \subseteq (\widehat{\lambda}^c)$$

$$\text{We have } \widehat{\mathbf{G}} \text{ cl}(\theta^{-1}(\widehat{\lambda}^c)) \subseteq \theta^{-1}(\widehat{\lambda}^c)$$

Hence

$$\widehat{\mathbf{F}}_{\widehat{\mathbf{G}}_1}(\theta^{-1}(\widehat{\lambda}^c)) > 0$$

$$\Rightarrow \widehat{\mathbf{F}}_{\widehat{\mathbf{G}}_1}(\theta^{-1}(\widehat{\lambda}^c))^c > 0$$

$$\Rightarrow \widehat{\mathbf{G}}_1((\theta^{-1}(\widehat{\lambda}^c))^c) > 0$$

$$\Rightarrow \widehat{\mathbf{G}}_1(\theta^{-1}(\widehat{\lambda})) > 0$$

Therefore  $\theta$  is an interval valued fuzzy weakly gradation preserving map.

**REFERENCES**

1. Akhtar zeb,Saleem Abpullah,Majip khan and AbdulMajid., "CUBIC TOPOLOGY",International Journal of computer science and information Security(UCSIS).V01 14,N0.8,August 2016
2. Chang,C.L.(1968), "Fuzzy Topological Spaces, journal of Mathematical Analysis and Applications",24,182-190.
3. Chattopadhyay,K.C., Hazra, R.N., and Samanta, S.K., "Gradation of openness: Fuzzy Sets and Systems," 49(1992),237-242.
4. Chattopadhyay, K.C., Hazra, R.N., and Samanta, S.K., " Fuzzy Topology : Fuzzy Closure Operator, Fuzzy Compactness and Fuzzy Connectedness, Fuzzy Sets and Systems," 54(1993),207-212.
5. M.B.Gorzalzano, " A method of inference in approximate reasoning based on interval valued fuzzy sets", "fuzzy sets and sets" ,21,1-17,1987.
6. M.Gehre,C.Walker,E.walker(1996). "some comments on interval valued fuzzy ses",Int.Journal of Intelligent systems11(10),pages751-759.
7. Hazra, R.N., Samanta, S.K., and Chattopadhyay, K.C., "Fuzzy Topology Redefined, Fuzzy Sets and Systems," 45(1992), 79-82.
8. JU Hongmei,Yuan Xuehai., "Fuzzy connectedness in interval-valued fuzzy topological spaces",second Internatinal symposium on Intelligent Information Technology and security informatics.
9. Y.B.Jun,C.S.Kun,K.U.Yang., "cubic sets and operations on cubic sets",volume 4,No.1.(JULY2012)PP 83-98 .
10. Tapas kumar ,Mondal and S.K Samanta, "Topology of interval valued fuzzy sets",Indian J.pure appl.Math.30(1):23-38.
11. I.B Turksen., " Interval-valued fuzzy sets based on normal forms", " fuzzy sets and system" 20(1986)191-210.
12. I.B.Turksen., " Interval valued fuzzy sets and compensatory and fuzzy sets and system"51(1992)295-307.
13. C.K. Wong , "Fuzzy Topology :Product and Quotient Theorems", Journal of Mathematical Analysis andApplications,Vol.45,no.2,pp.512-521,1974.
14. L.A.Zahed., "Fuzzy sets",Inform.control8(1965)338-353.
15. L.A.Zadeh, " The concept of a linguistic variable and its application to approximate reasoning-I." Inform.sci.8 (1975),199-249.





## A Sophisticated IOT - based Healthcare Monitoring and Decision - Making System using Cognitive Algorithms

Annamalai. M<sup>1\*</sup> and X. Mary Jesintha<sup>2</sup>

<sup>1</sup>Research Scholar, Department of Computer Science, Bharathiar University, Coimbatore, Tamil Nadu, India.

<sup>2</sup>Research Supervisor, Guest Lecturer, Department of Computer Science, Periyar University, Salem, Tamil Nadu, India.

Received: 23 Oct 2021

Revised: 28 Nov 2021

Accepted: 21 Jan 2022

### \*Address for Correspondence

#### Annamalai.M

Research Scholar,  
Department of Computer Science,  
Bharathiar University,  
Coimbatore, Tamil Nadu, India



This is an Open Access Journal / article distributed under the terms of the **Creative Commons Attribution License** (CC BY-NC-ND 3.0) which permits unrestricted use, distribution, and reproduction in any medium, provided the original work is properly cited. All rights reserved.

### ABSTRACT

The number of bedridden patients and geriatrics with chronic diseases is quickly rising around the world, and lifelong monitoring is essential due to a critical shortage of caregivers. This project intends to improve the role of caregivers by developing portable patient monitoring systems and medicine pill dispenser devices using new technology. This system consists of an IoT device with sensors that can detect the state of the patient's body as well as the information of the pill dispenser. Patients' health status is obtained through cloud services to doctors, who can then process and assess the patients' current state. Furthermore, the well-designed web services significantly promote the generation of reports based on previous data, which aids the doctor in making decisions. Registry Service Selection (RSS) and Augmented Data Recognize (ADR) based protected Internet of Things with imperative control technique for medical applications are discussed in this research paper.

**Keywords:** medication pill dispenser, Augmented Data Recognition, Registry Service Selection, Internet of Things, Sensors.

## INTRODUCTION

Modern lifestyles and hectic lives cause a slew of problems, and people are prone to forgetting important details. If they are suffering from a serious illness or disease, it is critical that they take their medications as prescribed by their doctor. If the patient is at home, the patient's relatives or guardians can remind him or her to take his or her medication at the appropriate time [1]. Regardless, it is difficult for relatives to educate the patients about the medicine every time. As a result, the patient should have access to a facility that will remind them when it is time to

38184



**Annamalai and Mary Jesintha**

take their medicine. The developed software is an IoT-enabled system that sends users timely alerts and messages to inform them of their medication intake [2]. One such effort is performed in this study to plan a clever multipurpose gadget that allows patients to take their medications on time. This container is a capable framework that preserves temperature and stickiness in a controlled range indicated by the drug manufacturer, so maintaining the medicines' strength. As a result, we've created a cloud service that's suitable for IoT monitoring and that stores and regulates the MEDIBOX's usefulness for further examination and future plan changes. MEDIBOX [3] takes charge of reminding patients to take their medications by providing voice alerts and driving signals for the correct medication, while keeping a strategic distance from the wrong medication at the wrong time. It also confirms the medication taken by patients, as well as the timings. If a patient fails to take medicine on time, an IoT warning is sent to the guardian, who is then responsible for the situation. This assures patients not to miss medicine [4].

Both hardware and software programming parts are included in the design [5].The hardware consists of several sensors, as well as Raspberry Pi and Arduino .The processing phases are as follows: medicine reminder system, a variety of sensor esteems, cloud storage of sensor data and patient history for making sense and decisions via web-based programming, and mobile application alerting system. The pill and dose esteems have been refreshed as a result of the abnormalities. To investigate the development of a patient assistance framework based on Quality Function Deployment (QFD) in the Internet of Things (IoT) environment, researchers used IoT innovation, Registry Service Selection (RSS), and Augmented Data Recognize (ADR) strategy to create a quiet assistance model to detect and remind patients' physical condition [6].

**Literature Survey**

IoT has been used to track patient health in several significant medical research. The following is a list of the work that has been done in this field. Various IoT-based health care applications have seen considerable developments in recent years. The patient support model is based on deep learning algorithms that can filter the physiological data of patients who have been out of commission for a long time and are unable to turn over constantly in order to gain a basic understanding of their physical condition. Patients can receive tailored attention that varies from person to person as a result of the administration framework's findings, reducing the workload of medical staff [7, 8].The system met predicted goals, such as constant wellbeing checking, scheduled timely drug, unscheduled emergency medicine, life-saving emergency reporting, life-saving emergency prediction, and early-stage diagnosis, based on the underlying analysis [9].Provides healthcare administration from the medical clinic to the house in [10].In this framework, provide sorts of help via IMedBox (Intelligent Medicine Box) and set up some IOT coordinate sensible health-related improvements and administrations by using data and correspondence innovation and applying them directly into home conditions[11].Remote patient monitoring in healthcare applications, in particular, offers a variety of offices and benefits by obtaining IoT-based smart home innovations without sacrificing security requirements or a potentially significant number of risks [12,13].Cloud-based IoT and data-focused IoT are anticipated to govern the design of an IoT application in [14].The approach aids in the detection of anomalous behaviour on suspect nodes, as well as the high-precision improvement of contaminations by the fuzzy classifier [15].

**Problem statement**

People nowadays are so preoccupied that they neglect to remind themselves about old age-related drugs. This erroneous dosage could result in major health complications or even death. It's difficult to remember to take the medicine's name. There is no defined methodology for sharing information across platforms, despite the fact that there are many research on medical management and the Internet of Things in the literature. Existing solutions limit the security options available in resource-constrained contexts. Current IoT sensors, data, and application environments are made up of a variety of technologies that don't work well together.





### Annamalai and Mary Jesintha

#### Proposed Solution

The suggested framework includes a medication box that is connected to the emergency clinic's organization and monitoring system through the internet. The emergency clinic organization monitors the normal nuances via a site page that is managed by the medical clinic. The ESP8266 Wi-Fi module is used to provide Wi-Fi capabilities to the device in order to transfer the patient's data that is monitored by the sensors. UART is used to connect it to Arduino (Universal Asynchronous Transmitter and Receiver). A serial interface is also used to connect GSM to the controller. Figure 1 depicts the proposed system's flowchart. It consists of an automated pill dispenser box and a decision support system for monitoring patient health conditions. This intelligent system is controlled by two algorithms: Registry Service Selection (RSS) and Augmented Data Recognize (ADR). The system has three sensors for monitoring the patient's health. Sweating Probe, Temperature sensor, and Heartbeat sensor are used to measure perspiration, patient temperature, and heartbeat. The sweating probe and the temperature sensor LM35 will provide analogue output to the microcontroller, and the readings will be presented on a website developed for monitoring reasons.

The output from the heartbeat sensor will be digital, and it will be sent to the microcontroller as well. The heartbeat's value will be posted on the webpage that has been created. If the value exceeds the program's reference values, the GSM module will send an SMS alert to the patient's caretaker, informing them that the patient's health is not good. The I2C interface connects the RTC DS307 to the Arduino, which keeps track of timings for medicine. It has the potential of automated switching if the power fails for some reason. The name of the medicine will be displayed on the system's LCD to the patient. automated switching capabilities The name of the medicine will be displayed on the system's LCD to the patient. When the drug is taken, the patient presses the confirmation key, which is connected to the microcontroller and provides digital output. The security and number of services are boosted by employing RSS and ADR. In addition, the Web services will give the doctor and the patient with precise visualisations of historical data and remedial treatments. Another excellent feature of this system is the ease with which it can detect a patient's pill history, health issues, and treatment history, all of which may be relevant to a new assigned doctor.

#### Registry Service Selection for IoT Control Algorithm

The suggested Registry Service Selection (RSS) security algorithm has been designed to give close assistance to information throughout the distributed computing process, whether in the cloud or on the ground. Most of the accessible programmes were employed in this manner to safeguard the major data from unapproved parties.

The proposed procedure is divided into four stages.

First, the design oversees the client's enrollment with the Cloud Service Provider (CSP).

The information is stored in distributed storage at the second stage.

The data recovery request is validated by the client in the third stage.

In the final phase, the confirmed client retrieves registry information from the cloud and verifies the integrity of the retrieved data, thereby providing data to registered users while employing all security methods.

#### Registry Service Selection Algorithm Steps

IoT as a source of data (UserIdUId ,UserLocationUloc)

Output: a cloud service that has been chosen

C.S.

Step 1: Look up the user-id Uid.

Step 2: Scan the user's Uloc.

Step 3: Examine the service information (sd) and history of the service (sh).

Step 4: Based on the Uloc location, select available services.

(i=1) = Service Selection (S.S.)

$N \llbracket Mx(sh) \times (Sd(Uloc)) \rrbracket$

Mx-Minimum frequency of service, N-Number of available services

Step 5: S.S. must be returned.



**Annamalai and Mary Jesintha****Augmented Data Recognize for IoT Control Algorithm**

Medical management is a type of organization that can be utilized to keep track of today's tools.

ADR Sensors are sensitive to loading information due to machine learning and considerable data detection. This innovation aids in the management of company devices. To utilize the system for the first time, users must first log in. After authenticating the user's credentials, the crucial parts.

All user information is saved here as a cloud server. The following are the components of a cloud server:

Admin (Alert): Control the system and send a message to the cloud server.

Technician: When a cloud problem arises, the server can resolve it.

Remote Monitoring: Sensors are used to automate the process.

It will decide whether or not to send a warning via SMS or email.

**ADR Control Procedure for Case: (Medical Working Environment)**

The first step is to start the KERNEL.

Connecting the sensors is the second step.

Step 3: Collecting data from all sensors

Step 4: Inputting sensor data into the software

**Algorithm for the Program**

Install one pilot wire channel and interact with the sensor in step one.

Set the time interval in step two.

Step 3: Select the appropriate drivers

Step 4: Make a temperature-recording output file.

Step 5: Create a sensor variable.

Step 6: Cloud Sensor Show –Display Sensor Video

The usual parameters are obtained using a variety of sensors, which are then sent to the cloud using the Raspberry Pi data controller. Based on proposed controller processing, the Web services use such data to identify concerns with pill remaining boxes and patient reports. The difference in flow rates between the several parameters is used to calculate the error rate.

**RESULTS AND DISCUSSION**

The proposed system's results and performance analysis are discussed in this section. The developed Registry Service Selection (RSS) and Augmented Data Recognize security algorithm-based IoT system and programming for medical evaluation structure were investigated. The proposed system's performance is compared to the following existing approaches. FRBCA (Flexible Route Based Congestion Avoidance) and DRA (Distributed Route Aggregation) are two approaches to congestion avoidance (DRA). The improved technique divides the work process into various stages, with data transfer capability and assets distributed independently at each level. Furthermore, the minimization method is implemented at each stage to determine the ideal amount of people who belong to the management complex in the current step. Some scenarios will be decided by a calculation. The level of safety to the comparative result is shown in Figure 3 and Table 1, and it should be noted that the proposed technique created a greater level of security than others. When compared to existing approaches, the suggested ADR performs better against brute force attacks (87%), web-based attacks (82%), and unknown attacks (82%). (84 percent ). Figure 4 depicts the Cloud area's availability dependent on the service. The proposed ADR approach achieves excellent outcomes in every operational state when compared to existing methods. The proposed ADR approach achieves excellent outcomes in every operational state when compared to existing methods. The performance analysis of Time complexity using various methodologies is shown in Figure 5. This comparison clearly shows that, as compared to existing approaches, the suggested ADR provides a low time complexity value. In comparison to previous approaches, the suggested ADR method The time complexity is 1.3 seconds for 50 sites, 1.9 seconds for 100 locations,





**Annamalai and Mary Jesintha**

and 2.03 seconds for 100 locations. This comparison clearly shows that, when compared to existing approaches, the suggested ADR has a low time complexity value when compared to traditional methods. When compared to existing approaches, the suggested ADR method requires the least amount of time.

**CONCLUSION**

The goal of this study is to create a smart IoT service system for patients. The patient care model is through the Registry Service Selection and Augmented Data Recognizing Method, with the use of Internet of Things technology. It can keep track of someone who has been bedridden for a long time. It is unable to transmit the patient's physiological data in real time in order to have access to the patient's body. There is a preliminary knowledge of the situation. Patients can receive tailored care that differs from person to person as a result of the service system's outcomes, decreasing the workload of medical staff. The present medical management system was resolved in this research work by using RSS and ADR techniques to model the continuous dynamics of plants as well as the discrete character of the control logic. In the long run, it aims to provide medical administration and security checks via the Internet.

**REFERENCES**

1. Gómez, J., Oviedo, B., and Zhuma, E., Patient Monitoring System Based on Internet of Things. *Procedia Comput. Sci.* 83:90–97, 2016.
2. .Albahri, O. S. et al., Systematic Review of Real-time Remote Health Monitoring System in Triage and Priority-Based Sensor Technology: Taxonomy, Open Challenges, Motivation and Recommendations. *J. Med. Syst.* 42(5):80, May 2018.
3. .M. Saravanan, A. M. Marks (2018), MEDIBOX — IoT enabled patient assisting device. 2018 IEEE 4th World Forum on Internet of Things (WF-IoT)
4. .Islam, M.M., Rahaman, A. & Islam, M.R. Development of Smart Healthcare Monitoring System in IoT Environment. *SN COMPUT. SCI.* 1, 185 (2020). <https://doi.org/10.1007/s42979-020-00195-y>
5. Taştan, Mehmet. (2018). IoT Based Wearable Smart Health Monitoring System. *Celal Bayar Üniversitesi Fen Bilimleri Dergisi.* 343-350. 10.18466/cbayarfbe.451076.
6. N. A. Gunathilake et al. Next Generation Lightweight Cryptography for Smart IoT Devices: Implementation, Challenges and Applications. In 2019 IEEE 5th World Forum on Internet of Things (WF-IoT), pages 707–710, Apr. 2019.
7. Huang, A., Cao, J. & Zhang, H. Construction of patient service system based on QFD in internet of things. *J Supercomput* (2020). <https://doi.org/10.1007/s11227-020-03359-y>
8. Varghese 1, G.Swathi2, Non-Invasive Haemoglobin Measurement System Using IoT And Mobile Devices, *International Journal of Innovative Research in Science, Engineering and Technology (IJIRSET)*, Volume 9, Issue 4, pp. 1306-1309, April 2020
9. Jagtap A., Chougule A., Pujari S., Khamkar A., Machhale G. (2020) Intelligent Medicine Box for Medication Management Using Internet-of Things. In: Kumar A., Paprzycki M., Gunjan V. (eds) ICDSMLA 2019. Lecture Notes in Electrical Engineering, vol 601. Springer, Singapore. [https://doi.org/10.1007/978-981-15-1420-3\\_15](https://doi.org/10.1007/978-981-15-1420-3_15)
10. Jaiswal K., Anand V. (2021) A Survey on IoT-Based Healthcare System: Potential Applications, Issues, and Challenges. In: Rizvanov A.A., Singh B.K., Ganasala P. (eds) *Advances in Biomedical Engineering and Technology*. Lecture Notes in Bioengineering. Springer, Singapore. [https://doi.org/10.1007/978-981-15-6329-4\\_38](https://doi.org/10.1007/978-981-15-6329-4_38)
11. Talal, M., Zaidan, A.A., Zaidan, B.B. et al. Smart Home-based IoT for Real-time and Secure Remote Health Monitoring of Triage and Priority System using Body Sensors: Multi-driven Systematic Review. *J Med Syst* 43, 42 (2019). <https://doi.org/10.1007/s10916-019-1158-z>
12. Baker, Stephanie & Xiang, Wei & Atkinson, Ian. (2017). Internet of Things for Smart Healthcare: Technologies, Challenges, and Opportunities. *IEEE Access*. PP. 1-1. 10.1109/ACCESS.2017.2775180.



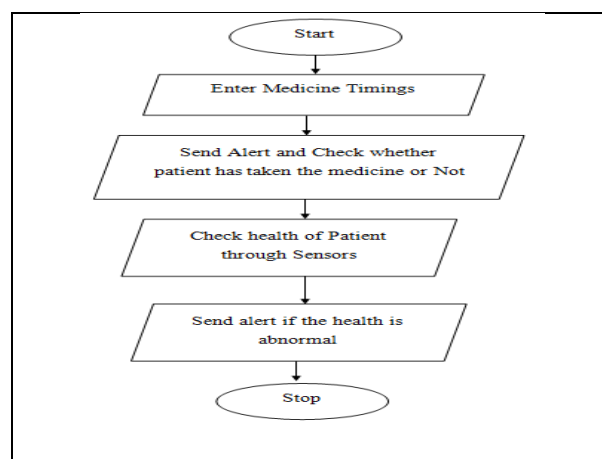


**Annamalai and Mary Jesintha**

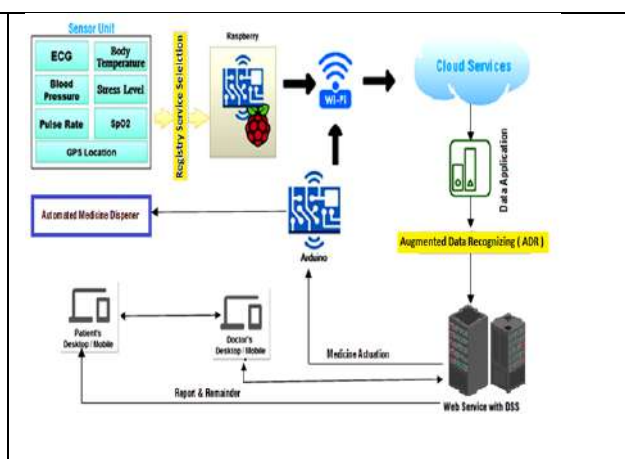
13. Latif, G., Shankar, A., Alghazo, J.M. et al. I-CARES: advancing health diagnosis and medication through IoT. *Wireless Netw* 26, 2375–2389 (2020). <https://doi.org/10.1007/s11276-019-02165-6>
14. Mahendran, Rakesh & v, Parthasarathy. (2020). A secure fuzzy extractor-based biometric key authentication scheme for a body sensor network on the Internet of Medical Things. *Computer Communications*. 153. 10.1016/j.comcom.2020.01.077.
15. Oyaga, Jaime & Pozo, Francesc & Tibaduiza Burgos, Diego & Anaya, Maribel. (2017). A Sensor Data Fusion System Based on k-Nearest Neighbor Pattern Classification for Structural Health Monitoring Applications. *Sensors*. 17. 1-26. 10.3390/s17020417.

**Table 1 Comparison of security performance**

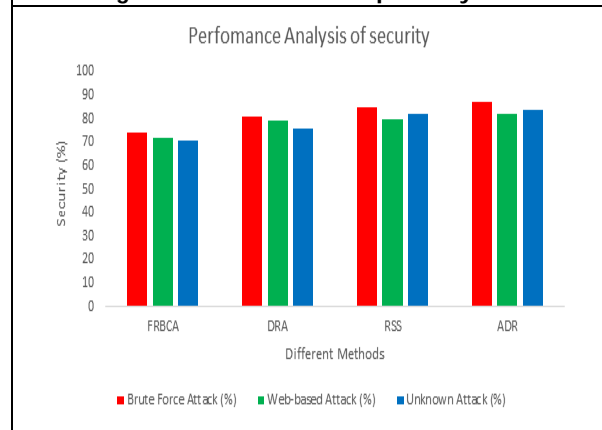
Algorithms	Brute Force Attack (%)	Web-based Attack (%)	Unknown Attack (%)
FRBCA	074	072	071
DRA	081	079	076
RSS	085	080	082
ADR	087	082	084



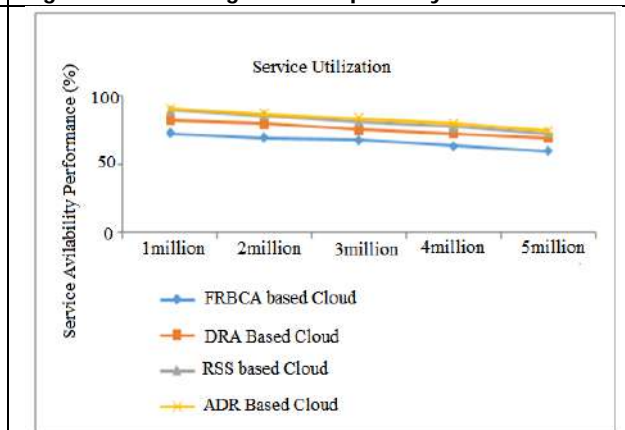
**Figure 1 : Flowchart of Proposed System**



**Figure 2. Block Diagram of Proposed system**



**Figure 3 Comparison of security level using RSS and ADR**

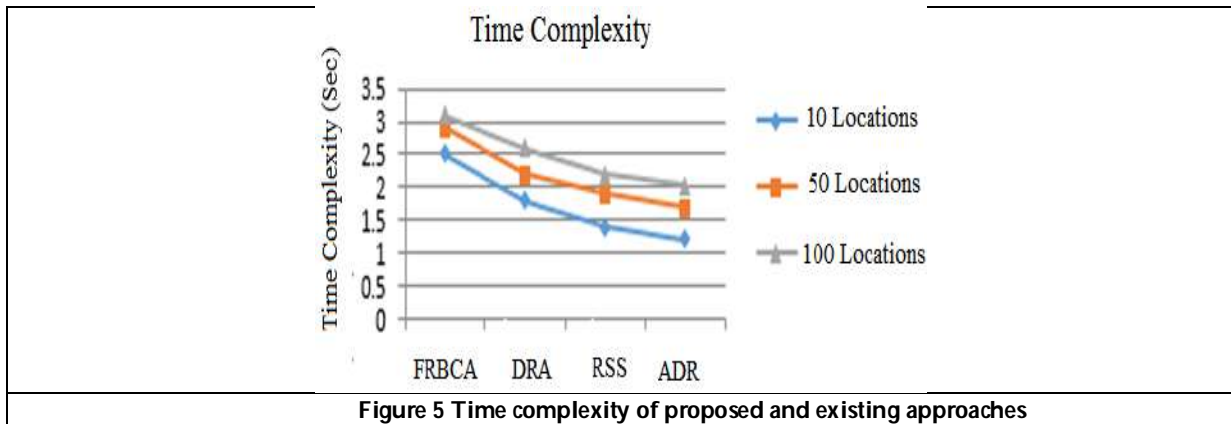


**Figure 4 Performance analysis - service availability routine using RSS and ADR**





**Annamalai and Mary Jesintha**





## Effective Practice of Online Research Activity and the Perception of Faculty in a Medical Institution

Senthil Kumar B<sup>1\*</sup>, Deepti Shastri<sup>2</sup> and K. Ezhilvendhan<sup>3</sup>

<sup>1</sup>Head, Central Research Laboratory for Biomedical Research, Vinayaka Mission's Kirupananda Variyar Medical College and Hospitals, Vinayaka Missions Research Foundation (Deemed to be University), Salem – 636308, Tamil Nadu, India.

<sup>2</sup>Deputy Dean, Professor in Anatomy, Vinayaka Mission's Kirupananda Variyar Medical College & Hospitals, Vinayaka Missions Research Foundation (Deemed to be University), Salem – 636308, Tamil Nadu, India.

<sup>3</sup>Dean, Professor in Ophthalmology, Vinayaka Mission's Kirupananda Variyar Medical College & Hospitals, Vinayaka Missions Research Foundation (Deemed to be University), Salem – 636308, Tamil Nadu, India.

Received: 20 Dec 2021

Revised: 03 Jan 2022

Accepted: 12 Jan 2022

### \*Address for Correspondence

#### Senthil Kumar B

Head, Central Research Laboratory for Biomedical Research,  
Vinayaka Mission's Kirupananda Variyar Medical College & Hospitals,  
Vinayaka Missions Research Foundation (Deemed to be University),  
Salem, Tamil Nadu, India.  
Email: skdrchinu88@gmail.com



This is an Open Access Journal / article distributed under the terms of the **Creative Commons Attribution License** (CC BY-NC-ND 3.0) which permits unrestricted use, distribution, and reproduction in any medium, provided the original work is properly cited. All rights reserved.

### ABSTRACT

The virtual learning materials help the participants within the research training program to access the protocols and updates effectively to participate in a professional health care research. Evaluate the effectiveness of online research activity in a medical institution and to assess the knowledge gained by the participants. The descriptive study was conducted in the medical college for the faculty and health researchers. Around 100 faculty of the institution were the participants of the activity. The study included a total of four research updates activity videos. The participants' perception was taken using questionnaire. The pre and post test scores were compared for the knowledge gained by the participants. The present study implies the importance of online activity for updating the participants' knowledge. The time constraint can be overcome by online activity through which the updates can be achieved by faculty at their own pace during their leisure time. The post test score was comparatively higher and significant than the pretest. The perception of participants includes various suggestions and feedbacks given by them on online activity. Virtual learning or activity through online mode of delivery will be very effective for the busy practitioners as they can update themselves. The participants also show interest for online activity as it allows more interactivity and adaptability to individual learner styles.



**Senthil Kumar et al.,****Keywords:** Online activity, Perception, knowledge, Kirkpatrick evaluation model

## INTRODUCTION

Education becomes transformative only when teachers and students synthesize and share the information across various subjects and their own experiences. Educators have to construct critical learning areas to encourage and increase the analysis, imagination, critical synthesis, artistic expression, knowingness and deliberateness [1]. It's changing progressively at several higher education institutions, offering fully online and/or hybrid/blended courses and activities combining online instruction with face-to-face teaching. The scope and availability of online training programs has expanded globally. Demand for more intensive, short-term courses and activities that provide opportunities for updating and up-skilling has increased through massive open online courses (MOOCs) and this increased demand has in turn expanded the availability of various online training programs [2]. Online modes of study have been found to be equivalent to on-campus environments with respect to key outcomes such as learner's performance [3] and learner's satisfaction.[4]. On-line programs also pose some key differences to on-campus modes of program. Accessing course materials or contents online allows more flexibility and accessibility for learners from around the world and helps to overcome the geographical barriers which might prevent them accessing on-campus course or training offerings [5]. There is also emerging evidence that online learners differ from on-campus learners with respect to various factors such as age and work or personal commitments [6,7]. Which also increases the demand for more flexible online program.[2]. In case of online course development, it is more complex to create a module than merely translating written materials to an online format; it requires careful planning and maximization of available online technologies for teaching-learning and assessment modes [8,9,10]. Online instruction places varying demands on delivery and feedback methods and relies on different teacher knowledge and skills than face-to-face training.[11].

The first absolutely online course was offered in 1981, and thereafter the 1<sup>st</sup> online program was established by the Western Behavior Sciences Institute within the following year.[12]. Within the mid-1980s, the first online undergraduate and graduate courses were initiated by several universities and schools.[1]. The advent of the World-Wide Web (WWW) in 1991 was a powerful catalyst for moving distance education forward, and was a milestone within the wider expansion and growth of online teaching and learning. Maloney et al., (2003) expressed that World Wide Web "facilitated the wide-spread use of web sites and therefore the development of online community teams supported by sites and various types of communications software"[13]. The virtual learning materials were developed to produce participants within the research training program access to protocols and professionally packaged biological science material to extend comprehension critical to effectively participate in a professional research laboratory.[14]. Katherine et al (2014) had done needs assessment among the residents. The residents stated that they would use an online resource dedicated to their research training and opted for an online program. Based on the aforementioned needs assessment results, they had created four foundational educational YouTube videos on the following topics: 1) critically evaluating research literature; 2) writing a research proposal; 3) submitting an application for research funding; and 4) writing a manuscript. Each educational video included a 10-min, narrated PowerPoint presentation (created by a topic expert from their center's research institute) and a 5-min video interview with another topic-matter expert from their center. The videos were designed to introduce residents to important research terms and concepts, explain organizational research policies and procedures, and introduce them to local topic matter experts who could assist them in the development of their research projects.[15]. The online training in research can be done effectively as sufficient time duration can be allotted to access the well planned and designed content along with assessments (Quiz), certification and recognition that can further create an interest in faculty to update themselves in research.

### Aim

Evaluate the effectiveness of online research activity in a medical institution.





Senthil Kumar *et al.*,

### Objectives

To assess the knowledge gained through online activity by the participants.

To interpret the perception of participants about the online activities.

## MATERIALS AND METHODS

The descriptive study of online activity on the research training was planned in the medical college for the faculty and health researchers. Around 100 faculty of the institution were the participants of the activity, who were selected by purposive sampling. The study includes a total of four research updates activity videos. The videos were designed to introduce participants to important research concepts and updates as a trail of online training activity. The research update topics included: 1) research misconduct; 2) publication in indexed journals; 3) ICH – Good Clinical Practice (GCP); and 4) clinical trials which were chosen after the feedback of randomly selected faculty before the study. Each online activity video was recorded using an app (Mobizen) in android phone by narration in PowerPoint presentation. Each video recorded played upto 30 minutes minimum to a maximum of 45 minutes. The recorded videos were validated by 2 to 3 senior faculty (administrators) and then it was shared in an official whatsapp group of the institution through which the participants could get access to it. Each video posted was considered as an activity and which included an activity evaluation form (feedback) and a quiz for assessment of the knowledge gained by the participants. Maximum of one week's time was given to participants for accessing each activity in their leisure time and watch it at their own pace. The structured and validated activity evaluation form was given to the participants using google form, followed by the online quiz administered using google form. The pre and post test scores were compared for all the 4 activities using one-way ANOVA and the post hoc pair-wise comparison was done to compare the scores of all the 4 activities to assess the knowledge gained by the participants through the online activity.

## RESULTS

Effective online training is dependent upon numerous factors like well-designed course content, driven interaction between the trainers and learners, well-prepared and fully-supported trainers; together with the creation of a way of online learning community; and rapid advancement of technology. Doing all of the above, was intended to stimulate an on-going discussion of effective ways that may enhance universities and faculty success in transitioning to show and train online [2]. The program evaluation feedback given by the faculty were based on all the 4 activities. The standard, validated activity evaluation questionnaire included 4 closed ended questions and 3 open ended questions. The closed ended questions included the overall assessment of the activity; achievement of activity objectives; and whether knowledge and information gained by the participants from participation in the activities had met their expectation and was useful / applicable in their work. The open ended questions included topics or aspects of the activity the participants found most interesting or useful, participants' opinion about the activity to be made more effective, further comments and suggestions (including activities or initiatives the participants think would be useful, for the future). Figure 1 gives the overall assessment of all the online activity conducted where most of the faculty felt that the activity was excellent and few suggested the activity was good and better. The perception of faculty on the achievement of objectives was 95.6% 'yes' and 4.4% was 'no' for the activity 1 where as for the other three activities the response for whether the objective was achieved was 100% (Fig 2). Fig.3 gives the perception whether knowledge and information of the activity met the participants' expectation. The faculty perception was yes (77.8%, 90.7%, 84%, 88.7%) for the activity 1 to activity 4 respectively where as may be (22.2%, 9.3%, 16%, 11.3%) and none of the faculty response was no. Around 66.7% to 76% of faculty felt that the activity will be definitely useful for them whereas 20% to 31.1 % felt that it was mostly useful and 2.2% of them felt that it was be somehow useful (Fig.4).

### Participants' suggestions and feedback on the online activity

The feedback was given below as verbatim of the faculty shared. When the faculty was asked for suggestions to make the activity more effective they stated as mentioned below,





Senthil Kumar et al.,

*“Live demonstration can be tried in Online mode, additional description and information required, doing activity online is difficult than doing personally. Thank you for engaging with some activity, content focused, it is useful for research guide and also for the researcher, it will be effective if everyone knows about this research updates before start-up of research activity and proper evaluation of the work during research process. Regular discussion of this activity helpful to improve the knowledge on research.”*The participants also were asked for comments and suggestions including activities or initiatives they think that would be useful, for the future. The feedback was as follows: *“Similar kind of topics to create awareness and much more knowledge about genuine research activities will be helpful, form a whatsapp group and discuss on a topic once weekly may be, it’s a good initiative. Series of online research activities followed by assessment and finally certification would benefit the institution as online course are developed and delivered by institution faculty. It was an excellent initiative, such type of activities to be conducted more frequently. The presentation was elaborate. It was so interesting and detailed presentation. Recent advances in various fields to be discussed. Prior classes about online research could have been taken, 2 sessions in a month would be better, excellent work in conducting online research series activities. Would be useful if an activity was planned on how to cite a reference in reference management tool in the upcoming sessions. Presentation was very much organized and precise, very informative.”* Table 1 gives the pretest and post test scores of the online activities of the participant in all the 4 activities and when analysed by one-way ANOVA both the pretest and post test scores were found to be statistically significant. When compared, the post-test scores were higher than the pretest scores (Fig 5). The post hoc pair-wise comparison of pre and post-test scores of all the 4 activities are given in the table 2.

## DISCUSSION

Francis et al. 2000 had delineated the experiences, lessons, and implications of building a virtual network as part of a biennial community health research analysis educational program. The above study provides a descriptive model of the processes concerned in developing, within the community health setting, virtual networks that may be used as the basis for future research analysis and as a practical guide for managers.[16]. Aggarwal et al. 2011 had compared the impact and satisfactoriness of teaching 2 distinct content areas, biostatistics and research ethics, through either on-line distance learning format or routine on-site coaching, in a randomized study in India. On-line and on-site coaching formats proved to marked and similar enhancement of data in biostatistics and research ethics. This, combined with logistical and cost advantages of on-line training, may make on-line courses particularly useful for expanding health research capacity in resource-limited settings.[17].

Demand for flexible online offerings has increased widely as the students want to upskill, re-train, and undertake further study. It is suggested that the accelerated nature of learning in intensive settings may place additional demands on students, instructors, and support mechanisms.<sup>2</sup> Researchers and policy-makers are progressively operating along with the goal of creating research that’s centered on resolution of real-world problems; but, knowledge translation (KT) activities, and therefore the partnerships they usually need, is challenging. The planning, development and participant experiences associated with the small number of training initiatives need to be addressed. There is insufficient evidence available at present to identify the most effective models for training researchers in KT and partnership skills.[18]. Continued research is needed to inform learner outcomes, learner characteristics, course setting, and institutional factors associated with delivery system variables so as to check learning theories and teaching models inherent in course design.[19].

The present study implies the importance of online activity for updating the participants’ knowledge. Time constraints are always a big problem for the faculty to update themselves on various changing key concepts in this competitive world. The time constraint can be overcome by online activity through which the updates can be achieved by faculty at their own pace during their leisure time. The interest on updating themselves on various concepts still remain kindled in all the faculty when the factors such as feasibility, approach, easy to access, longer duration allotted (time), well planned and designed, assessments like small quiz to create interest to update, certification and recognition were taken into account. Similar to the present study the virtual learning materials were proved to be successful in engaging faculty in blended learning. Lisa et al 2013 reported that the faculty responds





Senthil Kumar *et al.*,

positively to the virtual learning materials. By providing faculty with access to the professionally developed website before engaging in hands-on lab-work, they were able to spend time reviewing techniques and protocols.[20].A training program can be evaluated at various levels. A popular approach to evaluation of training, the Kirkpatrick evaluation model, delineates four levels of learning outcomes [21].

These include: (i) Reaction (assessment of participants' reaction to and satisfaction with the training program); (ii) Learning (degree of increase in intended knowledge, skills, attitudes and confidence); (iii) Behavior (application of learnt knowledge and skills); and, (iv) Results (degree of targeted outcomes). Aggarwal *et al.*, had assessed only the first two domains.<sup>17</sup>In the present study also the first 2 domains were assessed. The 3<sup>rd</sup> and the 4<sup>th</sup> are higher-level domains, which cannot be easily assessed as it needs long-term training programs. On-line activity provides enormous advantages when compared to that of routine on-site training, especially in case of building research capacity in resource-limited settings. On-line courses are more flexible, convenient and easily accessible,[22,23]. especially for busy clinicians and it allows interactivity and adaptability to individual learner styles.[22,24]. Also, online courses or activities can be accessed by a large number of participants.

## CONCLUSION

Asynchronous online learning benefited the faculty of our institution working fulltime, by giving them the flexibility they needed. It was less stressful for faculty as the content could be accessed without interference with their other workplace commitments. Faculty could access content at their own pace and at their own time. Furthermore, asynchronous learning gave faculty more time to reflect on the content resulting in better quality of work. Online learning catered to their individual learning styles and helped participants to develop higher levels of learner engagement. They appreciated the opportunity they got to develop new skills and to enhance existing ones. The faculty was motivated to adopt online research activity as they saw it as a means for career development.

## ACKNOWLEDGEMENT

The authors acknowledge all the faculty participants of Vinayaka Mission's Kirupananda Variyar Medical College and Hospitals, Salem for their active participation, co-operation and valuable genuine feedback about the online activity. The author also acknowledges the administrators of the institution for providing all the facilities, support and guidance for the activity.

### Conflicts of interest of each author/ contributor

nil

## REFERENCES

1. Sun A, Chen, X. Online education and its effective practice: A research review. *Journal of Information Technology Education: Research*.2016;15:157-190.
2. Roddy C, Amiet DL, Chung J, Holt C, Shaw L, McKenzie S, Garivaldis F, Lodge JM, Mundy ME. Applying Best Practice Online Learning, Teaching, and Support to Intensive Online Environments: An Integrative Review. *Front. Educ*.2017;2:59.
3. Magagula CM, Ngwenya AP. A comparative analysis of the academic performance of distance and on-campus learners. *Turk. Online J. Distance Educ*.2004;5:1-11.
4. Palmer S. Understanding the context of distance students: differences in on- and off-campus engagement with an online learning environment. *J. Open Flexible Distance Learn*.2012;16:70-82.
5. Bates AW. *Technology, e-Learning and Distance Education*. London: Routledge.2005.
6. Bailey M, Ifenthaler D, Gosper M, and Kretzschmar M, *et al.* Factors influencing tertiary students' choice of study mode, in *Rhetoric and Reality: Critical Perspectives on Educational Technology*. Proceedings ascilite Dunedin.2014;251-261.







**Senthil Kumar et al.,**

7. Johnson GM. On-campus and fully-online university students: comparing demographics, digital technology use and learning characteristics. *J. Univ. Teach. Learn. Pract.*2015;12:11–51.
8. Rovai AP. In search of higher persistence rates in distance education online programs. *Internet Higher Educ.*2003;6:1–16.
9. Grant MR., and Thornton, H. R. Best practices in undergraduate adult-centered online learning: mechanisms for course design and delivery. *MERLOT J. Online Learn. Teach.*2007;3:346–356.
10. Rovai AP., and Downey JR. Why some distance education programs fail while others succeed in a global environment. *Internet Higher Educ.*2010;13:141–147.
11. Alvarez I, Guasch T, and Espasa A. University teacher roles and competencies in online learning environments: a theoretical analysis of teaching and learning practices. *Eur. J. Teach. Educ.*2009;32:321–336.
12. Harasim, L. Shift happens: Online education as a new paradigm in learning. *Internet and Higher Education.*2000;3:41-61.
13. Maloney-Krichmar D, & Abras C. History of emergence of online communities. In K. Christensen & D. Levinson (Eds.), *Encyclopedia of community: From village to virtual world.* Thousand Oaks: Sage Publication.2003;1023-1027.

**Table 1: Pre and post test scores of online activities**

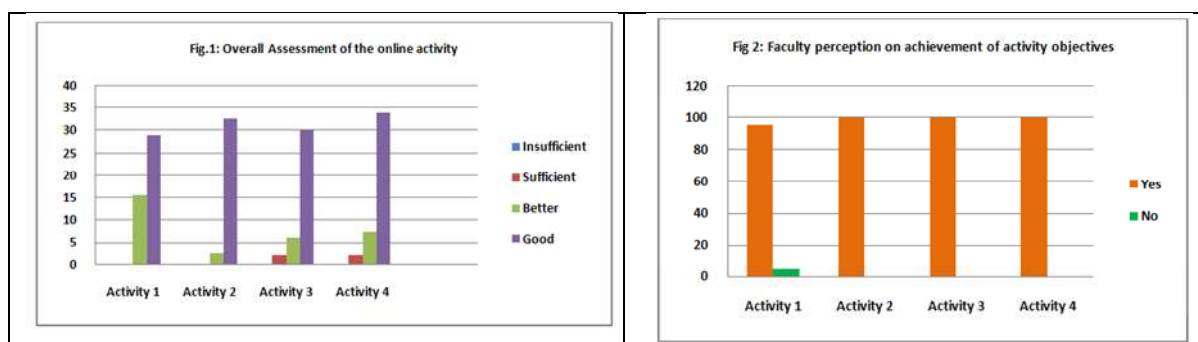
Online Activities	Pre-test Score <i>Mean±SD</i>	Post-test Score <i>Mean±SD</i>
Activity 1	4.83±0.95	8.88±1.30
Activity 2	3.97±1.04	7.43±1.60
Activity 3	5.49±1.04	9.43±1.46
Activity 4	4.94±1.06	8.77±0.97
F value	13.12	13.70
P value	0.0001 *	0.0001 *

Values are expressed as Mean ± SD, n = 30, \* - significant, P value \*P<0.001. Statistical analysis –One way ANOVA.

**Table 2: Post Hoc Pair-wise comparison of pre and post test scores of online activity**

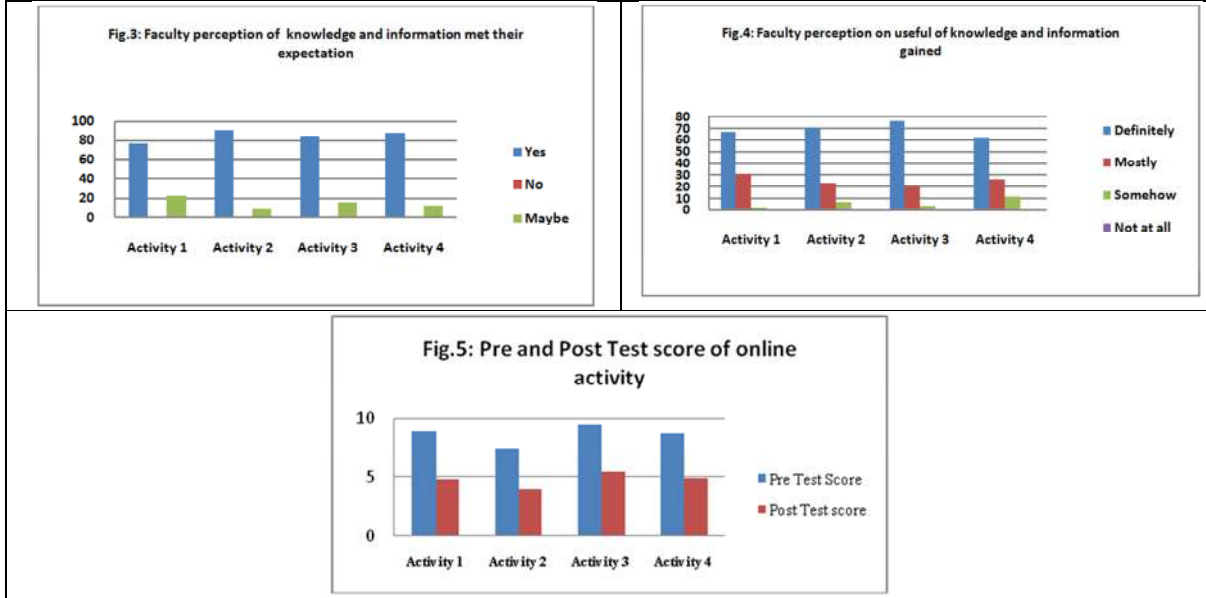
Post Hoc Pair wise Comparison	Pre-test Score	Post-test Score
A1 vs A2	P <.01	P <.01
A1 vs A3	P <.05	Non-significant
A1 vs A4	Non-significant	Non-significant
A2 vs A3	P <.01	P <.01
A2 vs A4	P <.01	P <.01
A3 vs A4	Non-significant	Non-significant

A1- Activity 1. A2 – Activity 2, A3 – Activity 3, A4 – Activity 4, vs – versus, significant, P value P<.05 &P<.01. Statistical analysis –Tukey HSD Post Hoc Pair wise comparison.





**Senthil Kumar et al.,**





## A Comparative Study on the *In vitro* Wound Healing Potency of Ethanolic Leaf Extract of *Cyclea peltata* and *Tiliacora acuminata* – A Nature Based Approach

Maniarasan Uthirapathi<sup>1</sup>, Nagarajan Nalliah<sup>2</sup>, Keerthiga Manohar<sup>3</sup> and Sowmiya Arunbabu<sup>4\*</sup>

<sup>1</sup>Research Scholar, Department of Ancient Science, Tamil University, Thanjavur, Tamil Nadu, India.

<sup>2</sup>Associate Professor, Department of Ancient Science, Tamil University, Thanjavur, Tamil Nadu, India.

<sup>3</sup>Assistant Professor, Department of Biotechnology, Cauvery College for Women, Trichy, Tamil Nadu, India.

<sup>4</sup>Research Scholar, Department of Biotechnology, Bishop Heber College Trichy, Tamil Nadu, India.

Received: 21 Nov 2021

Revised: 23 Dec 2021

Accepted: 21 Jan 2022

### \*Address for Correspondence

**S. Sowmiya Arunbabu**

Research Scholar,

Department of Biotechnology

Bishop Heber College.

Trichy -17, Tamil Nadu, India.

Email: sowmiasounderr@gmail.com



This is an Open Access Journal / article distributed under the terms of the **Creative Commons Attribution License** (CC BY-NC-ND 3.0) which permits unrestricted use, distribution, and reproduction in any medium, provided the original work is properly cited. All rights reserved.

### ABSTRACT

In an ever-changing exterior environment, skin ensures that a constant internal environment could be retained. The inflammatory and proliferative phases of the immune system are triggered when a wound on the skin forms. Wound healing is a complex process of cellular and biochemical interactions involving various cells such as keratinocytes, fibroblasts and endothelial cells. The aim of this study was to assess the wound healing potential of *Cyclea peltata* and *Tiliacora acuminata* extracts by *in vitro* methods, as well as to investigate their *in vitro* cytotoxicity assay with special emphasis on phenolic compounds. *In vitro* cytotoxicity was performed against Human Breast Cancer cell line (MCF-7) and Mouse fibrosarcoma cell line (L929) using ethanol extract of *Cyclea peltata* and *Tiliacora acuminata*. *Tiliacora acuminata* against L929 cell lines showed 23.77% with CTC<sub>50</sub> value >1000µg/ml whereas *Cyclea peltata* plant extract show cytotoxicity effect of 25.49% and with CTC<sub>50</sub> value >1000µg/ml. *Cyclea peltata* and *Tiliacora acuminata* was 285.9 and 342.42µm under 250 and 500 µg/ml. Moreover, we compared ethanolic and aqueous extracts obtained by maceration and Soxhlet methods. The wound healing significant was very high in *Tiliacora acuminata* than the ethanol extract of *Cyclea peltata* and positive control (2% DMEM). Investigation on the chemical constituents and biological activities of this plant could be helpful in future studies searching for alternative drugs.

**Keywords:** *Cyclea peltata*, *Tiliacora acuminata*, Cytotoxicity Assay, Wound healing



**Maniarasan Uthirapathi et al.,**

## INTRODUCTION

Medicinal plants contain various pharmacologically bioactive compounds and that have been used as medicine since ancient times (Bhat and Al-Daihan, 2014). Phytochemical constituents are playing a significant role in the identification of crude drugs. (Rotimi Larayetan *et al.*, 2019). The interest mainly arises from the belief that green medicine is safe and dependable, compared to costly synthetic drugs which are invariably associated with adverse effects (Maobe *et al.*, 2013). The study was carried out in comparison of pharmacological activities between the selected two medicinal plants of Menispermaceae family.

Wound contraction is aided by collagen formation and the development of granulation tissue. As a result, recent wound healing research is concentrating on the discovery of novel therapeutic drugs that stimulate the activation and modification of collagen-producing fibroblasts (Srinivasa Rao *et al.*, 2019). The wound healing process passes through four major phases such as hemostasis, inflammation, proliferation and remodelling (Krishnan 2006). The proliferative phase overlaps with the inflammatory phase. The most important cell is fibroblast which is responsible for initiating angiogenesis, epithelialization and collagen formation (Komarcevic 2000). Hence, preparations to augment other inevitable mechanisms responsible for wound healing are of prime importance and need to be explored. Several plant compounds are reported to have enhanced wound healing activity.

Chemoprevention, which consists of the use of synthetic or natural agents (alone or in combination) to block the development of cancer in human beings, is an extremely promising strategy for cancer prevention. The control of cell proliferation is fundamental in maintaining cellular homeostasis and loss of this mechanism is a principle hallmark of cancer cells. Thus the inhibition of tumor cell growth without side effects is recognized as an important target for cancer therapy (Koppikar *et al.*, 2010). The compound shrunken cytoplasm and damaged cell membrane of cancer cells, revealed elevated levels of reactive oxygen species and increased caspase 8, 9 & 3 for apoptosis of cells by activation of caspase pathways (Bhagya *et al.*, 2019).

Cytotoxic specificity of plant extracts is expected to be due to the occurrence of different classes of compounds in the extract, as it has been documented in the case of known classes of compounds (Cragg *et al.*, 1994). The cytotoxic activity was carried out by using standard MTT assay. The reduction of MTT can only take place in metabolically active cells and the level of activity is a measure of the viability of the cells (Wilson and John, 2000). The amount of cells was found to be proportional to the extent of formazan production by the cells used. MTT reduction as a cell viability measurement is now extensively chosen as the most advantageous end point (Wahab *et al.*, 2009). In the present study has been formulated to analyse the comparative evaluation of the cytotoxic and pharmacological analysis of *Cyclea peltata* Lam and *Tiliacora acuminata* Lam. collected from study area.

## MATERIALS AND METHODS

### Plant Sample Collection

#### Collection of Plant Materials

The plants material was collected from the Kolli hills air dried under a shade at room temperature i.e. 24°C for at least two weeks. The powders were then sealed in air-tight polyethylene bags and stored in a cool dry place.

#### Preparation of Crude Extract

Extracts were prepared using the cold extraction methods. The crude extracts obtained were; chloroform extract, ethanol extract and water extract. After extraction, the extracts were concentrated by evaporation using a rotary evaporator (Perkins, UK), weighed and reconstituted in respective solvents to a concentration of 1g/ml. These samples were then stored in a refrigerator at 4°C



**Maniarasan Uthirapathi et al.,****Cytotoxicity Studies****MTT Assay - *In vitro* cytotoxicity Assay (Mosmann, 1983, Monks, et al., 1991)****Cell Line**

The human breast cancer cell line (MCF 7) was obtained from National Centre for Cell Science (NCCS), Pune and grown in Eagles Minimum Essential Medium containing 10% fetal bovine serum (FBS). The cells were maintained at 37°C, 5% CO<sub>2</sub>, 95% air and 100% relative humidity. Maintenance cultures were passaged weekly, and the culture medium was changed twice a week. L929 (Mouse fibrosarcoma) cell line was procured from National Centre for Cell Sciences (NCCS), Pune, India. Stock cells were cultured in DMEM supplemented with 10% inactivated Fetal Bovine Serum (FBS), penicillin (100 IU/ml), streptomycin (100 µg/ml) and amphotericin B (5 µg/ml) in an humidified atmosphere of 5% CO<sub>2</sub> at 37°C until confluent. The cells were dissociated with TPVG solution (0.2% trypsin, 0.02% EDTA, 0.05% glucose in PBS). The stock cultures were grown in 25 cm<sup>2</sup> culture flasks and all experiments were carried out in 96 microtitre plates (Tarsons India Pvt. Ltd., Kolkata, India).

**Preparation of Test Solutions**

For Wound healing studies, each weighed test drugs were separately dissolved in distilled DMSO and volume was made up with DMEM supplemented with 2% inactivated FBS to obtain a stock solution of 1 mg/ml concentration and sterilized by filtration. Serial two fold dilutions were prepared from this for carrying out cytotoxic studies.

**Cell Treatment Procedure**

The cell culture was trypsinized and the cell count was adjusted to 1.0 x 10<sup>5</sup> cells/ml using DMEM containing 10% FBS. To each well of the 96 well microtitre plate, 0.1 ml of the diluted cell suspension (approximately 10,000 cells) was added. After 24 h, when a partial monolayer was formed, the supernatant was flicked off, washed the monolayer once with medium and 100 µl of different test concentrations of test drugs were added on to the partial monolayer in microtitre plates. The plates were then incubated at 37° C for 3 days in 5% CO<sub>2</sub> atmosphere, and microscopic examination was carried out and observations were noted every 24 h interval. After 72 h, the drug solutions in the wells were discarded and 50 µl of MTT in PBS was added to each well. The plates were gently shaken and incubated for 3 h at 37° C in 5% CO<sub>2</sub> atmosphere. The supernatant was removed and 100 µl of propanol was added and the plates were gently shaken to solubilize the formed formazan. The absorbance was measured using a microplate reader at a wavelength of 540 nm. The percentage growth inhibition was calculated using the following formula and concentration of test drug needed to inhibit cell growth by 50% (CTC<sub>50</sub>) values is generated from the dose-response curves for each cell line.

$$\% \text{ Growth Inhibition} = 100 - \frac{\text{Mean OD of individual test group}}{\text{Mean OD of control group}} \times 100$$

**RESULTS**

The present study has been formulated an comparison to evaluate the cytotoxic and pharmacological analysis between *Cyclea peltata* and *Tiliacora acuminata* collected from kolli hilly area. It was carried out in five different phases.

**Plant Sample Collection and Preparation**

Fresh leaves of the medicinal plant which are free from disease were collected from the Kolli Hilly areas, Namakkal district, Tamil Nadu and description of the plant sample was mentioned in figure 1 & 2. The plant material was washed thoroughly 2 – 3 times with running tap water. All the plant materials were then air dried under shade condition. The total dried mass was grounded to a fine uniform powder using mixture grinder. The dried powder was stored in an air tight container away from moisture with proper labelling. The plant powder was used for further all experimental analysis.





### Preparation of Crude Extract

The extraction of phytochemicals present in the plant sample was depending upon the extraction conditions such as solvent polarity, extraction temperature and time. *Cyclea peltata* and *Tiliacora acuminata* plant sample was extracted with various solvents having increasing polarity. The whole plant powder was subjected to successive solvents (ethanol and chloroform) and water extraction. The extraction process was done at room temperature and time duration of incubation for three days. About  $42.98 \pm 0.03\%$  and  $11.14 \pm 0.1\%$  yield was obtained from water extract of *Tiliacora acuminata* and *Cyclea peltata* respectively and shows yellowish green colour, followed by ethanol extract and chloroform extract yield was  $7.63 \pm 0.29\%$ ,  $2.78 \pm 0.1\%$  and  $3.45 \pm 0.13\%$  and  $2.42 \pm 0.2\%$  respectively and was in dark green colour. From this analysis it was clear that the water extract has higher extractive value than ethanol and chloroform respectively. Hereby, the *Tiliacora acuminata* shows high yield than *Cyclea peltata* in all extracts. The extraction procedure should have efficiency to dissolve endogenous compounds that present in the plant sample for the further studies.

### In vitro Cytotoxicity Assay - MTT Assay

In MTT Assay, (Plate XXVII-XXIX) *In vitro* cytotoxicity was performed against human Breast cancer cell line (MCF-7) showed in Fig 3 and Mouse fibrosarcoma cell line (L929) using ethanol extract of *Cyclea peltata* and *Tiliacora acuminata* showed in Fig 4. Cells were treated with test samples at concentrations ranging from 62.5 – 1000  $\mu\text{g/ml}$  for 72hrs and then the percentage of cell viability was analysed. Among the test agents, *Tiliacora acuminata* has 68.25% cytotoxic effect against human Breast cancer cell line (MCF-7) with  $\text{CTC}_{50}$  value of 279.10  $\mu\text{g/ml}$  (Table 1) whereas, *Cyclea peltata* shows cytotoxicity (63.11%) with  $\text{CTC}_{50}$  value of 297.95  $\mu\text{g/ml}$ . Cytotoxicity effect of the *Tiliacora acuminata* against L929 cell lines showed 23.77% with  $\text{CTC}_{50}$  value  $>1000\mu\text{g/ml}$  whereas *Cyclea peltata* plant extract show cytotoxicity effect of 25.49% and with  $\text{CTC}_{50}$  value  $>1000\mu\text{g/ml}$  (Table 2). The plant extracts were significantly ( $P<0.01$ ) inhibited the proliferation of MCF-7 cells in a dose dependent manner. On treatment with ethanol plant extract of *Cyclea peltata* and *T. acuminata* the MCF-7 breast cancer cell line showed an increased rate of cell death at a lower concentration of the sample when compared to that in L929 cells (Figure 5 & 6).

### In vitro Wound Healing Activity

#### In vitro Wound Healing by Cell Migration Assay

Test formulations i.e. ethanol extract from *Cyclea peltata* and *Tiliacora acuminata* treatment enhanced the cell migration of L929 fibroblasts when tested by scratch wound assay (Fig 7). After 24hr of treatment with 250 and 500  $\mu\text{g/ml}$  of test formulations, the migratory nature of the fibroblast could be seen by microscopic examination. The cell migration towards the wounded area will heal the wound, the *Cyclea peltata* plant extract enhanced the cell migration about 107.2  $\mu\text{m}$  and 148.92  $\mu\text{m}$  in 250 and 500  $\mu\text{g/ml}$  concentration (Fig 8). Whereas the *Tiliacora acuminata* ethanol extract showed 145.84  $\mu\text{m}$  and 164.84  $\mu\text{m}$  distance covered over the wound in 250 and 500  $\mu\text{g/ml}$  concentrations after 24 hrs incubation. After 48 hrs of incubation the cell migration was about 276.72 and 322.16  $\mu\text{m}$  under 250 and 500  $\mu\text{g/ml}$  by *Cyclea peltata* and that of *Tiliacora acuminata* was 285.9 and 342.42  $\mu\text{m}$  under 250 and 500  $\mu\text{g/ml}$  (Fig 9). The wound healing significant was very high in *Tiliacora acuminata* than the ethanol extract of *Cyclea peltata* and positive control (2% DMEM). This response was not recorded either in the cell culture plate maintained as untreated control or placebo treatment (Table 3).

### Fibroblast Proliferation Assay

An increased proliferation of fibroblast in response to treatment with ethanol extract of *Cyclea peltata* and *Tiliacora acuminata* on proliferation activity on L929 Cell lines was observed. The rate of proliferation was directly proportional to the concentration. However, concentration above 50  $\mu\text{g/ml}$  showed increase in the proliferation rate on dose dependent manner. Maximum increase in the proliferation of fibroblast in response to ethanol extract from *T. acuminata* at a concentration of 50  $\mu\text{g/ml}$  was  $71.86 \pm 2.0\%$  and showed maximum of  $64.10 \pm 1.1\%$  increase in proliferation was demonstrated using *C. peltata* ethanol extract, whereas in the positive control, 2% DMEM showed  $68.39 \pm 0.7\%$  increase in cell proliferation. (Table 4). Cell proliferation was insignificant in untreated and placebo treated control (Figure 10, 11).



**Maniarasan Uthirapathi et al.,**

## DISCUSSION

### ***In vitro* Cytotoxicity Assay**

Bearing this in mind, two cell lines of different histological origin were used in the present study. The cytotoxic activity was carried out by using standard MTT assay. This result showed that natural compounds present in ethanol extracts of both plants *C. peltata* and *T. acuminata* significantly ( $P < 0.01$ ) inhibited the proliferation of L929 cells and MCF-7 in a dose dependent manner. In two different test samples *T. acuminata* shows enhanced cytotoxicity activity with both cancer and normal cells. The test sample that will act successfully as an anti-cancer drug should kill cancer cells without causing excessive damage to normal cells, such as L929. Meena and Anandan, 2015 reported that methanolic extract of *C. peltata* exhibited reduction in tumor volume and tumor packed cell volume in a dose dependent manner *in vivo* in rat. Meena & Santhy, 2015 reported that the anticancer activity of methanolic extract of *C. peltata* by *in vitro* method, inhibition property against DAL cell lines as compared with the standard fluorouracil. Tetrandrine isolated from *C. peltata* have been reported for *in vitro* cytotoxic effect on Pancreatic (PANC-1) and breast (MDA-MB-231) cancer cells. The MTT reduction assay, IC<sub>50</sub> values of total alkaloids extracted were 0.8 (K-562), 1.4 (HL-60), 1.6 (MCF-7) and 1.7 (HeLa) µg/ml and that of ethanol extract of root were 1.9 (K-562), 2.7 (HL-60). The cell viability also measured by trypan blue dye exclusion method. Cell proliferation was assessed which was parallel to cell viability.

### **Cell Migration and Proliferation Assay**

The present study clearly suggests that *T. acuminata* plant extract enhances the cell proliferation and migration of L929 fibroblasts compared with the ethanolic extracts of *C. peltata*. Cell proliferation and cell migration are two important events necessary for wound healing (Chun-Chi Liang *et al.*, 2007). We have chosen L929 fibroblast cell line because, the fibroblasts play a major role in wound healing process, besides keratinocytes. Rammohan *et al.*, 2014 reported the wound healing activity of *T. acuminata* was studied on alloxan induced hyperglycaemic and normoglycaemic rats. The study gave the result of 95.19% healing by nitrofurazone, while the extract 87.13% healing and leaf juice showed the highest healing percentage of 94.19% wound healing. Test formulation contains the oil extract of *Wrightia tinctoria* which is known to have several medicinal properties including anti-inflammatory activity (Bigoniya *et al.*, 2008). The alcoholic extract of *Terminalia chebula* increases the protein, DNA and collagen synthesis in the granulation tissue during wound healing (Kannan *et al.*, 2009). However, the poly herbal extract (test formulation) of *Wrightia tinctoria*, *Aloe vera*, *Terminalia chebula* and *Curcuma longa* and its wound healing effect as evidenced by the enhanced cell proliferation and cell migration of fibroblast in a suitable vehicle base (gel) is novel (Suguna *et al.*, 2002).

## CONCLUSION

The results showed that ethanolic extract of *T. acuminata* was effective in enriching wound closure progression and contain several important antioxidant phenolic compounds. This species deserves further investigation aiming to isolate and identify the active compounds. This extract will be fractionated for comprehensive chemical identification using a variety of bioactive compound extraction procedures in order to be developed as a natural wound healing treatment.

### **Conflict of Interest**

The authors have no conflict of interest with any commercial or other association in connection with the submitted article

### **Author's Contributions**

All the contributing authors have participated in the preparation of the study.





**Maniarasan Uthirapathi et al.,**

## REFERENCES

1. Anitha, M., Sakthidevi, G., Muthukumarasamy, G., & Mohan, V. R. (2012). *In vitro* antioxidant potential of *Cynoglossum zeylanicum* (Vahl ex Hornem) Thunb.ex Lehm. whole plant (Boraginaceae). *International Journal of Chemistry and Pharmaceutical Sciences*; 3: 53 - 59.
2. Anjaneyulu, B., Govindachari, T. R., Sathe, S. S., Viswanathan, N., Gopinath, K. W., Pai, B. R. (1969). Alkaloids of *Tiliacora acuminata*. *Tetrahedron*; 25: 3091 - 3105.
3. Arnab, K., Tapan Seal, J., Rajan, V., Malaya, G., & Biswapati, M. (1999). Some pharmacological studies with tiliacorine, diphenylbisbenzylisoquinoline alkaloid from *Tiliacora racemosa*. *Natural Product Sciences*; 5(3): 142 - 147.
4. Arnab, K., Tapan Seal, J., Rajan, V., Malaya, G., & Biswapati, M. (2000). Effects of tiliacorine on voluntary muscle and blood pressure. *Natural Product Sciences*; 6(1): 44 - 48.
5. Aruoma, O. I. (2003). Methodological considerations for characterizing potential antioxidant actions of bioactive components in plant foods. *Mutation Research*; (523-524): 9 - 20.
6. Arvind, K. S. (2016). Medicinal plants: future source of new drugs. *International Journal of Herbal Medicine*; 4(4): 59 - 64.
7. Bigoniya, P., Shukla, A., Agrawal, G. P., Rana, A. C. (2008). Pharmacological screening of *Wrightia tinctoria* bark hydro alcoholic extract. *Asian Journal of Experimental Science*; 22(3): 235 - 244.
8. Bhat, R. S., Al-Daihan, S. (2014). Phytochemical constituents and antibacterial activity of some green leafy vegetables. *Asian Pacific Journal of Tropical Biomedicine*; 4(3): 189 - 193.
9. Bhagya, N., Chandrashekar, K. R., Prabhu, A., & Rekha, P. D. (2019). Tetrandrine isolated from *Cyclea peltata* induces cytotoxicity and apoptosis through ROS and caspase pathways in breast and pancreatic cancer cells. *In vitro Cellular & Developmental Biology - Animal*; 55(5): 331 - 340.
10. Bernardo, R. C., Fonseca, L. P., & Cecilia, R. C. C. (2019). Antibiotic discovery: where have we come from, where do we go?. *Antibiotics*; 8(2): 45.
11. Chun-Chi, L., Ann, Y. P., & Jun-Lin, G. (2007). *In vitro* scratch assay: a convenient and inexpensive method for analysis of cell migration *in vitro*. *Nature Protocols*; 2(2): 329 - 333.
12. Chung, K. T., Wong, T. Y., Wei, C. I., Huang, Y. W., & Lin, Y. (1998). Tannins and human health: a review. *Critical Reviews in Food Science and Nutrition*; 38(6): 421 - 464.
13. Cragg, G. M., Boyd, M. R., Cardellina, J. H., Newman, D. J., Snader, K. M., & McCloud, T. G. (1994). Ethnobotany and drug discovery: the experience of the US National Cancer Institute. *Ciba Foundation symposium*; 185: 178 - 190.
14. George, M., Joseph, L., & Jose, C. K. (2017). Phytochemical screening and in-vitro antimicrobial activity of various extracts of *Cyclea peltata* Lam. *International Journal of Innovative Science and Research Technology*; 2(11): 55 - 61.
15. Hossain, H., Howlader, M. S. I., Dey, S. K., Hira, A., & Ahmed, A. (2013). Antinociceptive and antidiarrhoeal activities of ethanolic leaf extract of *Tiliacora acuminata* (Lam.) Miers. *Turkish Journal of Pharmaceutical Sciences*; 10(3): 393 - 404.
16. Kannan, P., Ramadevi, S. R., & Waheeta, H. (2009). Antibacterial activity of *Terminaliachebulu* fruit extract. *African Journal of Microbiology Research*; 3(4): 180 - 184.
17. Krishnan, P. (2006). The scientific study of herbal wound healing therapies: Current state of play. *Current Anaesthesia & Critical Care*; 17(2): 21 - 27.
18. Komarcevic, A. (2000). The modern approach to wound treatment. *Medicinski pregled*; 53(8): 363 - 368.
19. Koppikar, S. J., Choudhari, A. S., Suryavanshi, S. A., Kumari, S., Chattopadhyay, S., & Kaul-ganekar, R. (2010). Aqueous cinnamon extract (ACE-c) from the bark of *Cinnamomum cassia* causes apoptosis in human cervical cancer cell lines (SiHa) through loss of mitochondrial membrane potential. *BMC Cancer*; 10: 210.
20. Maobe, M. A. G., Gatebe, E., Gitu, L., & Rotich, H. (2013). Preliminary photochemical screening of eight selected medicinal herbs used for the treatment of Diabetes, Malaria and Pneumonia in Kisii Region, Southwest Kenya. *European Journal of Applied Sciences*; 5(10): 1 - 6.







## Maniarasan Uthirapathi et al.,

21. Meena, J., & Anandan, S. (2015). Anti-tumor activity of methanolic extract of *Cyclea peltata*. *International Journal of Phytomedicine*; 7(2): 185 - 192.
22. Meena, J., & Santhy, K. S. (2015). Evaluation of the antioxidant potential of methanol
23. Extract of *Cyclea peltata* in DAL Model. *The Pharma Innovation Journal*; 4(1): 71 -75
24. Muhammad, A. A., Amir, H. Khan., Muhammad, A., & Habib, U. (2018). Traditional uses of medicinal plants used by Indigenous communities for veterinary practices at Bajaur Agency, Pakistan. *Journal of Ethnobiology and Ethnomedicine*; 14: 11.
25. Patil, S. H., & Yadav, S. S. (2003). Traditional medicinal plants of Satpuda, Nandurbar district Maharashtra state. *Indian forester*; 129(5): 1379 - 1387.
26. Ray, A. K., Mukhopadhyay, G., Mitra, S. K., Guha, K. P., Biswapathi, M., Atta, R., & Aisha, N. (1989). (+)-N Methyltiliamosine - an alkaloid from *Tiliacora acuminata*. *Photochemistry*; 28(2): 675 - 676.
27. Rotimi L., Zacchaeus S.O., Oluranti O.O., Ayodele L.(2019). Phytochemical Constituents, Antioxidant, Cytotoxicity, Antimicrobial, Antitrypanosomal, and Antimalarial Potentials of the Crude Extracts of *Callistemon citrinus*. *Evidence-Based Complementary and Alternative Medicine*, Article ID 5410923, (14) <https://doi.org/10.1155/2019/5410923>.
28. Singh, S., & Nisteshwar, K. (2013). Review of *Cissampelos pareira* & *Cyclea peltata* (Patha Dwaya) – ethnomedicinal perspectives. *The Global Journal of Pharmaceutical Research*; 2(1): 1656 – 1662
29. Srinivasa, R.B., Abeer, M. A., Reem Y.A., Janardhana, P.B., Padma, K.R., Vishnu. P.V., Aruthra, A.P., Shiva Shankar, R.G., Joel P.J., Krishna M.S.(2019). In vitro wound healing potency of methanolic leaf extract of *Aristolochia saccata* is possibly mediated by its stimulatory effect on collagen-1 expression. *Heliyon*, 5(5):e01648,ISSN 2405-8440,<https://doi.org/10.1016/j.heliyon.2019.e01648>.(<https://www.sciencedirect.com/science/article/pii/S2405844019314458>)
30. Suguna, L., Singh, S., Sivakumar, P., Padmavathi, S., & Chandrakasan, G. (2002). Influence of *Terminalia chebula* on dermal wound healing in rats. *Phytotherapy Research*; 16(3): 227 - 231.
31. Wahab, S. I. A., Abdul, A. B., Mohan, S. M., Zubairi, A. S. A., & Elhassan, M. M. (2009). Oncolysis of breast, liver and leukemia cancer cells using ethyl and methanol extracts of *Goniothalamus umbrosus*. *Research Journal of Biological Sciences*; 4: 209 - 215.
32. World Health Organization (WHO). (2002). WHO traditional medicine strategy 2002-2005.
33. Wilson, A. P., & John, R. W. (2000). *Animal Cell Culture: A Practical Approach*. Oxford: Oxford University Press.
34. Weimann, C., & Heinrich, M. (1997). Indigenous medicinal plants in Mexico. The example of the Nahua (Sierra de Zongolica). *Pharmaceutical Biology*; 110: 62 - 72.
35. Wet, H. D., & Wyk, B. E. (2008). An Ethnobotanical survey of southern African Menispermaceae. *South African Journal of Botany*; 74(1), 2 - 9.
36. Yoganarasimhan, S. N. (1996). Medicinal plants of India. *Interline publishing private limited- Bangalore, Karnataka*; 1: 82.

Table 1: *In vitro* Cytotoxicity of Ethanol Extract From *Cyclea peltata* and *Tiliacora acuminata* on MCF-7 Cell Lines

Concentration (µg/ml)	<i>Cyclea peltata</i>					<i>Tiliacora acuminata</i>				
	Absorbance	% cell viability	% growth inhibition	CTC <sub>50</sub>	R <sup>2</sup>	Absorbance	% cell viability	% growth inhibition	CTC <sub>50</sub>	R <sup>2</sup>
1000	0.484	36.89	63.11	297.95	0.8264	0.415	31.75	68.25	279.10	0.7897
500	0.636	47.27	52.73			0.627	48.41	51.59		
250	0.878	66.89	33.11			0.861	65.98	34.02		
125	1.03	82.57	17.43			1.01	81.07	18.93		
62.5	1.31	91.66	8.34			1.22	93.11	6.89		
Control	1.42	100	0			1.42	100	0		





Maniarasan Uthirapathi et al.,

**Table 2: In vitro Cytotoxicity Of Ethanol Extract From *Cyclea Peltata* And *Tiliacora Acuminata* On L929 Cell Lines**

Concentration (µg/ml)	<i>Cyclea peltata</i>					<i>Tiliacora acuminata</i>				
	Absorbance	% cell viability	% growth inhibition	CTC <sub>50</sub>	R <sup>2</sup>	Absorbance	% cell viability	% growth inhibition	CTC <sub>50</sub>	R <sup>2</sup>
1000	1.327	74.51	25.49	>1000	0.9078	1.196	76.23	23.77	>1000	0.8708
500	1.487	82.64	17.36			1.466	82.4	17.60		
250	1.494	83.93	16.07			1.527	85.91	14.09		
125	1.521	85.45	14.55			1.552	87.31	12.69		
62.5	1.554	88.3	11.70			1.625	91.53	8.47		
Control	1.780	100	0			1.780	100	0		

**Table 3: In vitro Wound Healing Effect Of Ethanol Extract From *Cyclea peltata* and *Tiliacora acuminata* on L929 Cell lines**

Concentration (µg/ml)	Wound size distance (µm) at 0 hour	Wound covered distance at 24 hrs (µm)	Wound covered distance at 48 hrs (µm)
<i>Cyclea peltata</i>			
250	516.2	107.2	276.72
500	526.96	148.92	322.16
<i>Tiliacora acuminata</i>			
250	644.08	145.84	285.9
500	628.9	164.84	342.42
Positive control (2% DMEM)	533.82	49.44	274.76
Negative control (1% DMSO)	744.46	No healing	56.38

**Table 4: Effect of Ethanol Extract From *Cyclea peltata* and *Tiliacora acuminata* on Proliferation Activity on L929 Cell lines**

Concentration (µg/ml)	Effect of ethanol extract % proliferation of <i>C. peltata</i>	Effect of ethanol extract % proliferation of <i>T. acuminata</i>
5	13.92±1.8	15.37±0.9
10	25.42±0.6	27.31±0.4
25	45.58±1.3	53.16±1.5
50	64.10±1.1	71.86±2.0
2% DMEM	68.39±0.7	





Maniarasan Uthirapathi et al.,

### *Cyclea peltata* (Lam.)

#### Systematic Description

**Kingdom :** Plantae  
**Division :** Angiosperms  
**Class :** Eudicots  
**Order :** Ranunculales  
**Family :** Menispermaceae  
**Genus :** *Cyclea*  
**Species :** *peltata*



Habit

**Habit :** Twining shrub and climber

**Occurrence :** Moist grasslands, sandy areas, rainforests, semi-deciduous and deciduous dry lowland forest.

**Altitude :** Upto 800 - 900 MSL.

**Root :** Tuberos cylindrical, greyish brown

**Stem :** Erect, 8cm long and Slender.

**Leaves :** Simple, Petiolate, Lamina Ovate.

**Flower :** Small, greenish yellow colour.

**Fruits :** Drupaceous.



Floral Parts

#### Ethnomedicinal Uses :

1. Root paste - To cure piles, applied on foot to leech-bite, stomach ache, toothache, jaundice, fever and asthma
2. Leaves powder - Tcoolant, antidandruff, fever, hypertension, cardiovascular diseases, etc.,



Tuber

Figure 1 *Cyclea peltata* (Lam.)





Maniarasan Uthirapathi et al.,

### ***Tiliacora acuminata* (Lam.)**

#### **Systematic Description**

**Kingdom :** Plantae

**Division :** Angiosperms

**Class :** Eudicots

**Order :** Ranunculales

**Family :** Menispermaceae

**Genus :** *Tiliacora*

**Species :** *acuminata*



**Habit**

**Habit :** Climbing shrubs

**Occurrence :** Moist grasslands, deciduous and deciduous dry lowland forest.

**Altitude :** Upto 800 - 900 MSL.

**Root :** Tuberous cylindrical, greyish brown

**Stem :** Erect, long and Slender.

**Leaves :** Alternate, Petiolate, Lamina Ovate.

**Flower :** Small, greenish yellow colour.

**Fruits :** Drupaceous.



**Floral Parts**

#### **Ethnomedicinal Uses :**

Effective for snake bite and scorpion sting.



**Drupe Fruit**

**Figure 2** *Tiliacora acuminata* (Lam)





Maniarsan Uthirapathi et al.,

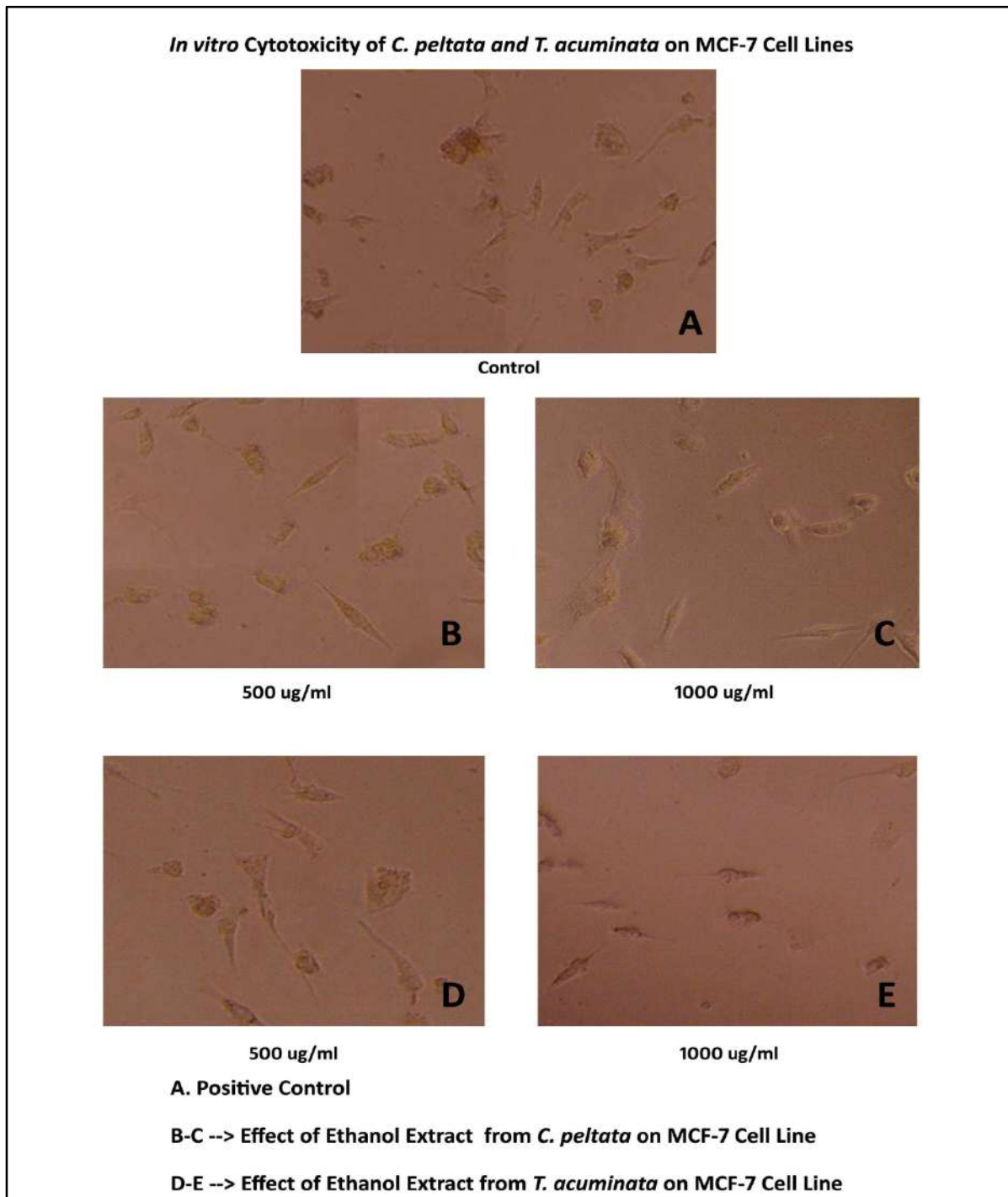


Figure 3 : *In vitro* cytotoxicity of *C. pelata* and *T.acuminata* on MCF-7 Cell line



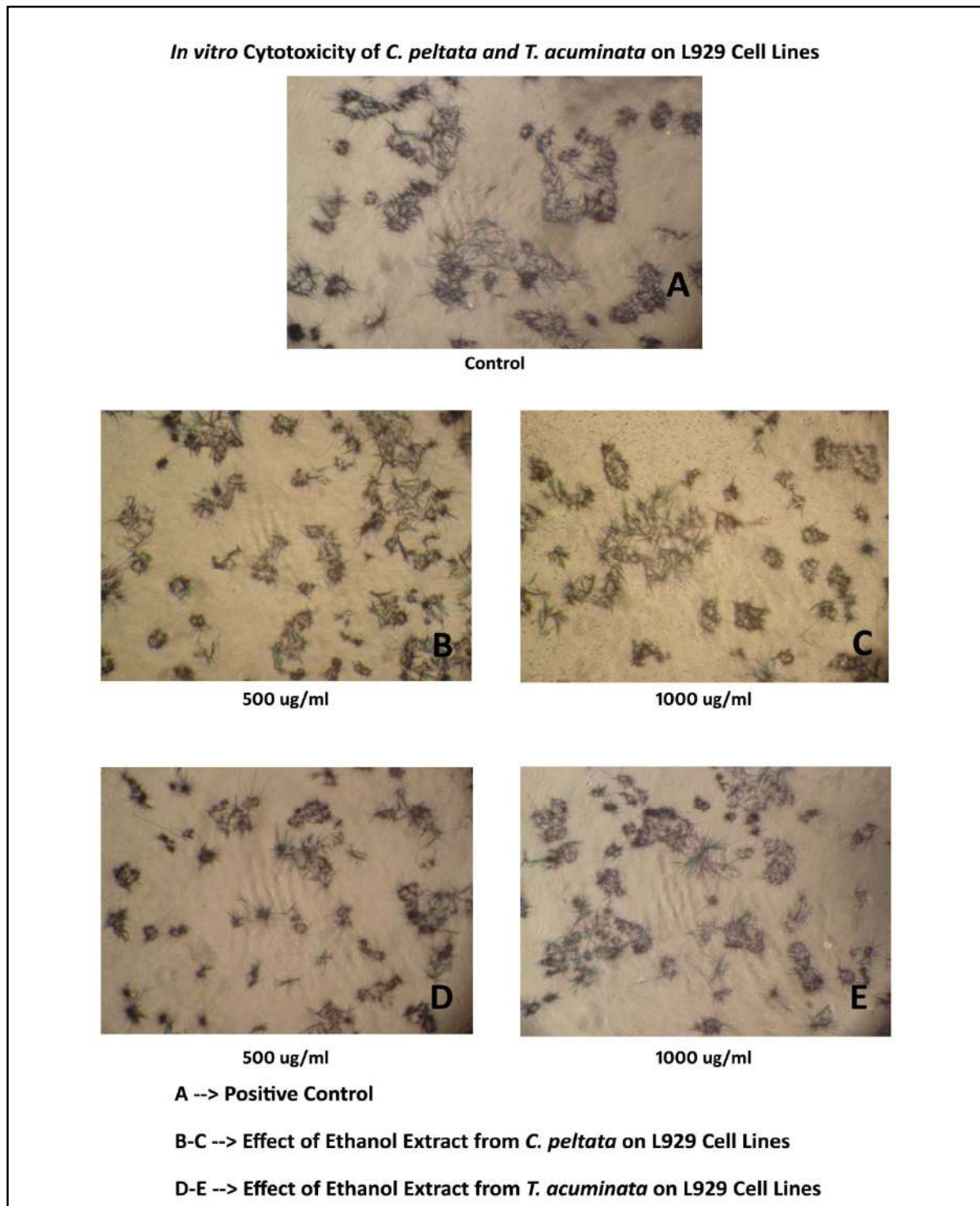


Figure 4 : *In vitro* cytotoxicity of *C.peltata* and *T.acuminata* on L929 Cell lines





Maniarasan Uthirapathi et al.,

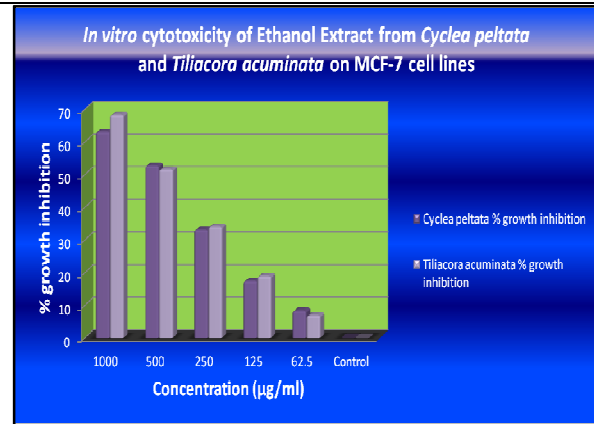


Figure 5: *In vitro* cytotoxicity of ethanol extract from *Cyclea peltata* and *Tiliacora acuminata* on MCF-7 cell lines

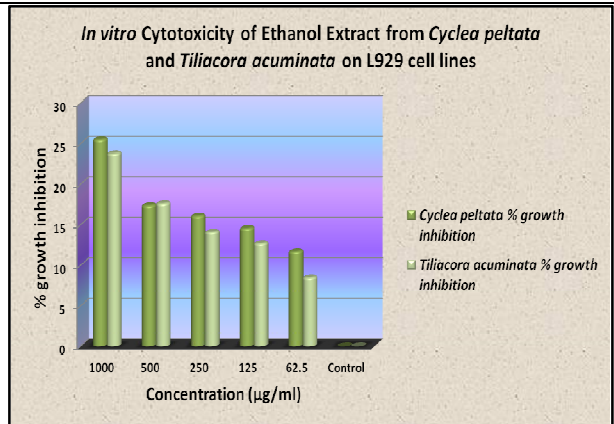


Figure 6: *In vitro* cytotoxicity of ethanol extract from *Cyclea peltata* and *Tiliacora acuminata* on L929 cell lines

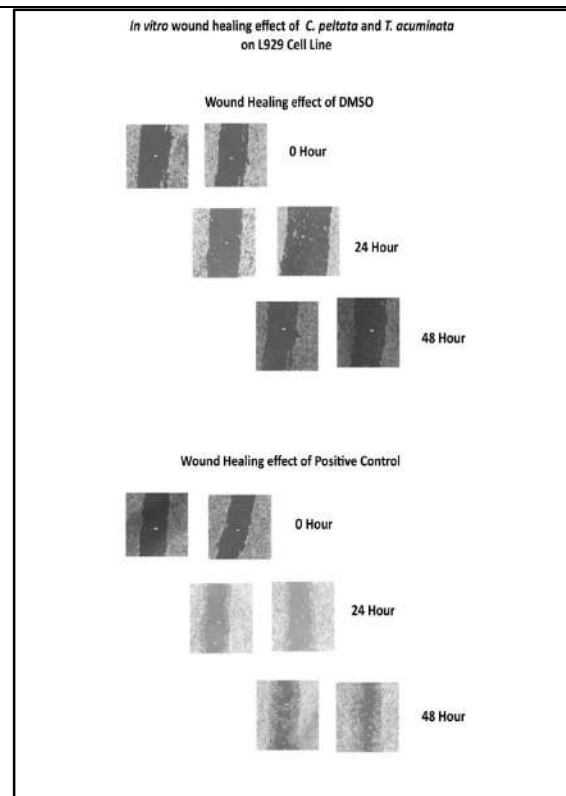


Figure 7 : *In vitro* Wound healing effect on *C.peltata* and *T.acuminata* on L929 Cell line

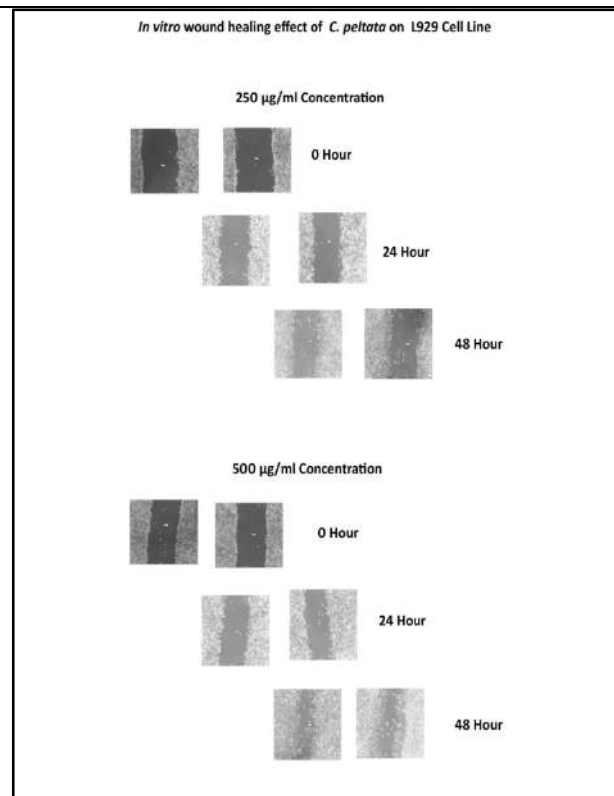


Figure 8 : *In vitro* Wound healing effect of *C. peltata* on L929 Cell line





Maniarsan Uthirapathi et al.,

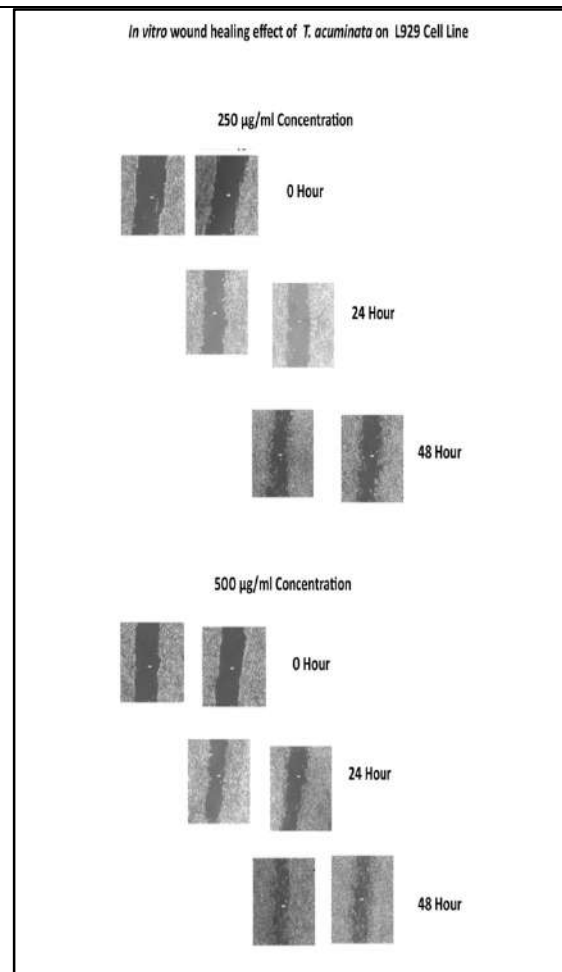


Figure 9 : In vitro Wound healing effect of *T.acuminata* on L929 Cell line

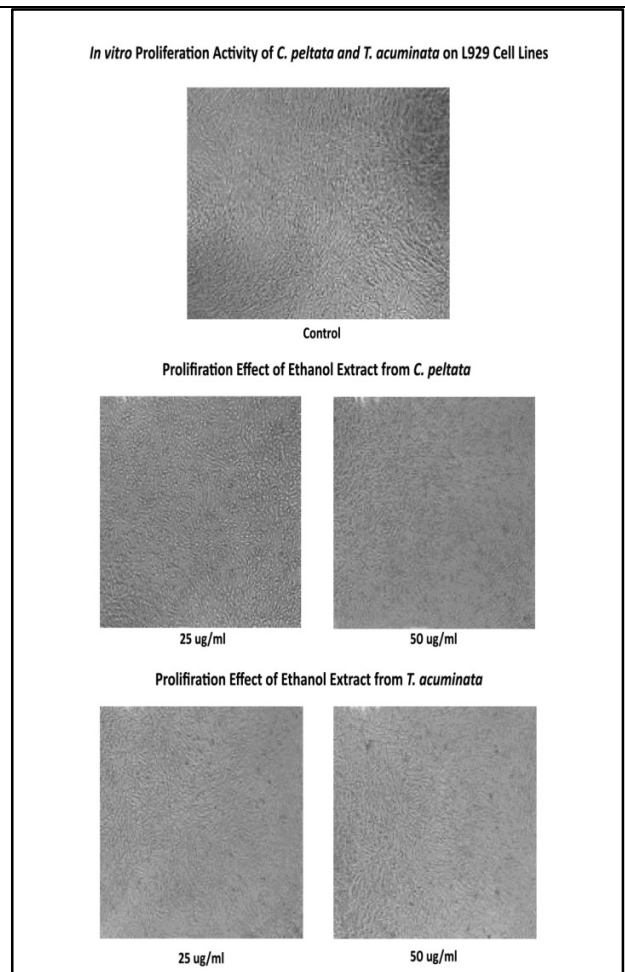


Figure 10: *In vitro* proliferation activity of *C.peltata* and *T.acuminata* on L929 Cell line

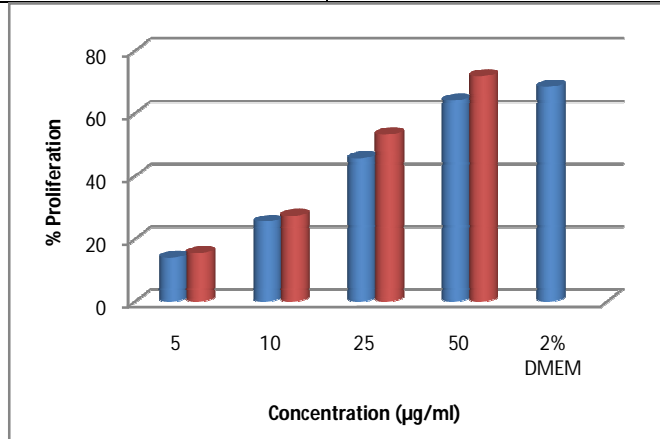


Figure 11 :Effect of ethanol extract from *Cyclea peltata* and *Tiliacora acuminata* on proliferation activity on L929 Cell lines







## A Comparative Study to Assess the Knowledge on Covid-19 Pandemic among Adults in Urban and Rural Areas

Amala Vennila.R<sup>1\*</sup> and N. Gaoudam<sup>2</sup>

<sup>1</sup>Principal, Mangala College of Nursing, Hassan, Rajiv Gandhi University of Health Sciences, Bangalore, Karnataka, India.

<sup>2</sup>Assistant Professor, Vinayaka Mission's College of Nursing, Karaikal, Vinayaka Mission's Research Foundation - (Deemed to be University) Salem, Tamil Nadu, India.

Received: 02 Dec 2021

Revised: 29 Dec 2021

Accepted: 12 Jan 2022

### \*Address for Correspondence

**Amala Vennila**

Principal,

Mangala College of Nursing,

Hassan, Rajiv Gandhi University of Health Sciences,

Bangalore, Karnataka, India.

Email: maheshsenthil@yahoo.com



This is an Open Access Journal / article distributed under the terms of the **Creative Commons Attribution License** (CC BY-NC-ND 3.0) which permits unrestricted use, distribution, and reproduction in any medium, provided the original work is properly cited. All rights reserved.

### ABSTRACT

Inhaled treatment has a superior efficacy to safety ratio than systemic therapy because therapeutic agents are given directly to the lung. Inhaled therapy has a faster beginning of action, is easier to administer, and has a better efficacy to safety ratio than systemic therapy. To determine the extent to which adults in urban and rural regions are aware of the Covid19 epidemic. The quantitative evaluative technique was used in this study, and the research design was a cross sectional study. A total of 60 persons were chosen using a multi-stage sample method. The demographic proforma and a self-structured questionnaire were used to obtain the data. The split half technique was used to assess the tool's dependability, and the result was  $r=0.70$ . The urban, with a mean score of 22.24.02 (SD) (74 percent of the overall mean score), has the highest level of knowledge, whereas in rural, the mean score was 15.3 3.02(SD), representing 51% of the overall mean score, indicating a difference of 26% in mean percentage of score. The estimated 't' value of 15.65, which is larger than the P0.05, indicates that the difference between the urban and rural scores is very significant. The study found that adults in urban regions had greater information than those in rural areas, and that rural areas require more awareness of the covid-19 epidemic.

**Keywords:** Asses, Knowledge, COVID 19, Urban areas.



**Amala Vennila and Gaudam****INTRODUCTION**

Individuals aged 60 and over are currently growing at three times the pace of the general population. Rapid breakthroughs in medicine, public health, nutrition, and sanitation have resulted in significant groups of people living to be elderly. By 2050, the ageing population is expected to reach 324 million, or 20% of the overall population, according to forecasts. Physical and mental health problems affect geriatric people more than they do the younger ones. Nearly 120 million senior people in India suffer from a variety of medical, psychological, economic, and spiritual issues [1]. Air inhalation is a necessary aspect of the breathing cycle for all living things. It is an autonomic mechanism that does not require conscious control or effort (though there are exceptions in some illness situations). Breathing, on the other hand, may be intentionally regulated or halted (within limits). Breathing permits oxygen to enter the lungs, where it may be absorbed into the bloodstream (which humans and many other creatures require for living). Inhaling steam may have a local impact. Steam pushed into the respiratory track's deeper passageways creates a huge surface area for absorption. Gases and mists injected into the lungs are quickly absorbed by the alveolar capillary network. Airways must not obstruct regular gas exchange by restricting the bronchiole. Inhaled treatment has a superior efficacy to safety ratio than systemic therapy because therapeutic agents are given directly to the lung. Inhaled therapy has a faster beginning of action, is easier to administer, and has a better efficacy to safety ratio than systemic therapy. The most prevalent cause of human alignment is chest congestion. They are a major contributor to India's rising morbidity and death rates. Many patients who have chest congestion require unscheduled visits to the emergency room. Control is still a public health issue that varies not only by individual but also by socioeconomic status. Patient education, health-care access, and prescription costs are all likely to have an impact on treatment outcomes [3].

**STATEMENT OF THE PROBLEM**

A comparative study to assess the knowledge on covid-19 pandemic among adults in urban and rural areas.

**OBJECTIVES**

1. To assess the knowledge regarding covid19 pandemic among adults in urban and rural areas
2. To find out the relationship between level of knowledge with urban and rural areas
3. To find the Association between the knowledge regarding home management of post hemodialysis with their selected demographic variables among patient receiving hemodialysis

**MATERIAL AND METHODS**

To examine knowledge on the covid19 pandemic, a community-based prospective cross-sectional survey was conducted. Namakal was chosen as the research location since it has both urban and rural regions. Adults living in both urban and rural locations made up the study's demographic. A total of 60 persons were chosen using a multi-stage sample method. The demographic proforma and the self-structured questionnaire were used to collect data. The researcher created a self-structured questionnaire that consists of 30 multiple choice questions to test knowledge on the covid19 pandemic. Each right response receives one point, while erroneous answers receive zero points. Abundant knowledge was defined as a score of 75 percent or above, fairly acceptable knowledge was defined as 51 to 75 percent, and poor knowledge was defined as a score of 50 percent or below. Cronbach's alpha was used to assess the tool's reliability, and the result was  $r=0.74$ . The study participants had given their informed consent. Both descriptive and inferential statistics were used to analyse the data. To determine the relationship with their chosen demographic variable, descriptive analysis was done to find frequency, percentage, central tendency like mean, standard deviation, and inferential statistics like chi square.



**Amala Vennila and Gaudam****RESULTS**

Table:1 frequency and percentage wise distribution of demographic variables of study participants. Table: 2 distribution of participants according to their level of knowledge on covid-19 pandemic. Table.3. showed that the overall mean, SD, and mean percentage of urban and rural knowledge scores are compared, it is discovered that the urban mean score is 22.24.02 (SD), which is 74 percent of the total mean score, whereas the rural mean score is 15.3 3.02 (SD), which is 51 percent of the total mean score, indicating a 26 percent difference in mean percentage of score. The estimated 't' value of 15.65, which is larger than the P0.05, indicates that the difference between the urban and rural scores is very significant. It was shown that adults in urban regions had higher knowledge than those in rural ones. So H1 was approved. The Chi square test was performed to determine the relationship between knowledge level and demographic characteristics such as age in years, gender, educational level, employment, marital status, religion, and so on. Educational status and source of information had a significant (p 0.05 level) relationship, but no other factors had a significant relationship.

**DISCUSSION**

COVID-19 is an emerging infectious disease that poses a significant threat to public health. Given the serious threats imposed by COVID-19 and the absence of a COVID-19 vaccine, preventive measures play an essential role in reducing infection rates and controlling the spread of the disease. This indicates the necessity of public adherence to preventive and control measures, which is affected by their knowledge, attitudes, and practices (KAP). Thus, this study aimed to assess the KAP of the Saudi population, for the novel coronavirus disease 2019, COVID-19 Our findings overall mean, SD, and mean percentage of urban and rural knowledge scores are compared, it is discovered that the urban mean score is 22.24.02 (SD), which is 74 percent of the total mean score, whereas the rural mean score is 15.3 3.02 (SD), which is 51 percent of the total mean score, indicating a 26 percent difference in mean percentage of score. The estimated 't' value of 15.65, which is larger than the P0.05, indicates that the difference between the urban and rural scores is very significant. It was shown that adults in urban regions had higher knowledge than those in rural ones.

Finally, the study findings may be useful to inform policymakers and healthcare professionals, on further public health interventions, awareness-raising, policies, and health education programs. Men were significantly less likely to have knowledge, optimistic attitudes, and appropriate or safe practices toward COVID-19. These findings are consistent with other studies showing that, in response to SARS and MERS, men were significantly less likely take preventive and protective measures than women . Our finding suggests that targeted health education interventions should be directed to this particular vulnerable population at high risk of contracting COVID-19. For example, COVID-19 knowledge may increase significantly, if health education programs are specifically targeted at men

**CONCLUSION**

The current findings revealed that the majority of people are inadequate knowledge regarding covid 19 in rural areas compared to urban. Due to lack of communication and awareness in rural areas belongs to inadequate knowledge. Regular checkup and camp from government and private organization about covid 19 pandemic to create awareness regarding covid 19 pandemic.

**REFERENCES**

10. Park textbook of preventive and social medicine; k.park; bhanot publishers; 20th dition. 2009, 408-13.
11. Pitkaranta A, Hayden FG. Rhinoviruses: important respiratory pathogens. *Ann Med.* 1998; 30: 529 - 537. [2].
12. Couch RB. The common cold: control? *J Infect Dis.* 1984; 150: 167 - 173. [3]. Diehl HS. Medicinal treatment of the common cold. *JAMA* 1933; 101: 2042 - 2049. [4].





**Amala Vennila and Gaudam**

13. Bender BG, Berning S, Dudden R, Milgrom H, Tran ZV. Sedation and performance impairment of diphenhydramine and secondgeneration antihistamines: a metaanalysis. *J Allergy Clin Immunol* 2003; 111(4): 770 - 776. [5].
14. Singh M, Singhi S, Walia BN. Evaluation of steam therapy in acute lower respiratory tract infections: a pilot study. *Indian Paediatr* 1990; 27: 945 - 951.
15. Ophir D, Elad Y. Effects of steam inhalation on nasal patency and nasal symptoms in patients with the common cold. *Am J Otolaryngol* 1987; 8: 149 - 153. [14].
16. Morris S, Eccles R, Martez SJ, Riker DK, Witek TJ. An evaluation of nasal response following different treatment regimes of oxymetazoline with reference to rebound congestion. *Am J Rhinol* 1997; 11: 109 - 115. [15].
17. Hendley JO, Abbott RD, Beasley PP, Gwaltney JM Jr. Effect of inhalation of hot humidified air on experimental rhinovirus infection. *JAMA* 1994; 271: 1112 - 1123. [16]. Macknin ML, Mathew S, Medendorp SV.
18. Effect of inhaling heated vapor on symptoms of the common cold. *JAMA* 1990; 264: 989 - 991. [17]. Forstall GJ, Macknin ML, Yen-Lieberman BR, Medendorp SV. Effect of inhaling heated vapor on symptoms of the common cold. *JAMA* 1994; 271: 1109 - 1111

**Table:1 Frequency and Percentage Wise Distribution Of Demographic Variables Of Study Participants**

**N: 60**

S.NO.	DEMOGRAPHIC VARIABLES	FREQUENCY	PERCENTAGE(%)
1.	Age in years		
	a) 65-70 Yrs	31	52.0
	b) 71-75 Yrs	15	25.0
	c) 76 -80 Yrs	6	10.0
	d) 81-85 Yrs	8	13.0
2.	Sex		
	c. Male	38	63.3
	d. Female	22	36.7
3.	Educational level		
	f. Primary education	20	33.3
	g. Secondary education	10	16.6
	h. Higher secondary education	15	25.2
	i. Diploma/degree	5	8.3
	j. Illiterate	10	16.6
5.	Marital Status		
	b. Married	45	75.0
	b. Unmarried	10	16.0
	c. Divorce	3	6.0
	a. Widow/Seperated	2	3.0
6.	Religion		
	d. Hindu	36	60.0
	e. Christian	12	20.0
	f. Muslim	12	20.0
7.	History of URTI		
	c. Yes	6	12.0
	d. No	25	50.0





**Amala Vennila and Gaudam**

**Table: 2 Distribution of Participants According to Their Level of Knowledge on Covid-19 Pandemic**

**N: 60**

Level of knowledge	Urban		Rural	
	Frequency	Percentage (%)	Frequency	Percentage (%)
Inadequate (<50%)	10	17	40	17
Moderate (51-75%)	15	25	10	25
Adequate (>75%)	35	58	10	58

**Table-3: Comparison of Mean, SD, and Mean Percentage of Pre-Test and Post- Test Knowledge Regarding Steam Inhalation Among Elderly Population**

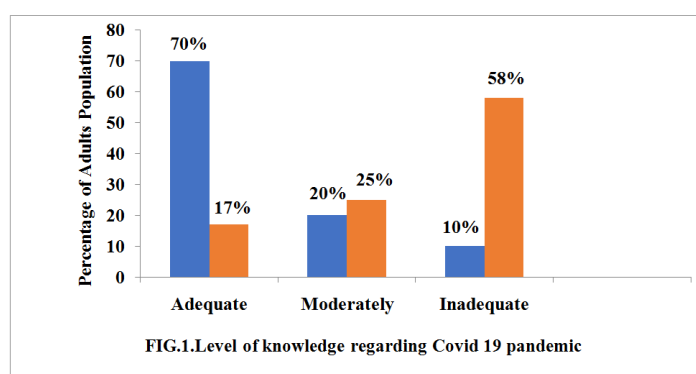
Area	Max score	Urban scores			Rural score			Difference in mean (%)	't' test Value
		Mean	SD	Mean %	Mean	SD	Mean %		
Knowledge on Covid19 pandemic	30	22.2	4.02	74	15.3	3.02	51	26	15.52* P=0.000 S

\*-Significant at 5% (p<0.05) level

**Table.4.Association between pre-test levels of knowledge regarding Covid19 pandemic among adults with their selected demographic variables**

S.NO.	DEMOGRAPHIC VARIABLES	X <sup>2</sup> Value	P- value	LEVELOF SIGNIFICANCE
1.	Education	10.088	0.030*	<b>SIGNIFICANT</b>
2.	Source of Information	11.423	0.002*	<b>SIGNIFICANT</b>

\*Significant at 5% p < 0.05 level



**Fig.1. Level of knowledge regarding Covid 19 pandemic**





## On Solving Special Type of Linear Diophantine Equation

R. Sivaraman\*

Associate Professor, Department of Mathematics, Dwaraka Doss Goverdhan Doss Vaishnav College, Arumbakkam, Chennai – 600 106, Tamil Nadu, India.

Received: 11 Dec 2021

Revised: 28 Dec 2021

Accepted: 12 Jan 2022

### \*Address for Correspondence

**R. Sivaraman**

Associate Professor,  
Department of Mathematics,  
Dwaraka Doss Goverdhan Doss Vaishnav College,  
Arumbakkam, Chennai – 600 106, Tamil Nadu, India.  
Email: rsivaraman1729@yahoo.co.in



This is an Open Access Journal / article distributed under the terms of the **Creative Commons Attribution License** (CC BY-NC-ND 3.0) which permits unrestricted use, distribution, and reproduction in any medium, provided the original work is properly cited. All rights reserved.

### ABSTRACT

Diophantine Equations plays a central role upon solving many interesting equations that arise in real life situations. Several mathematicians had contributed enormously towards understanding and finding methods for solving different types of Diophantine equations. In this paper, I will consider a specific linear Diophantine equation and use it to determine date and month of any person born on any date in a particular year. The method adopted in this paper for solving is completely novel and new. Few illustrations were provided to explain the method described.

**Keywords:** Linear Diophantine Equation, Integer Solutions, Greatest Common Divisor, Euclidean Algorithm, Infinitely Many Solutions.

## INTRODUCTION

Diophantine Equations are equations with some specific positive degree and whose solutions are integers. They are named after ancient Greek mathematician Diophantus who wrote the wonderful treatise titled "Arithmetica". In this work, Diophantus had described 130 amusing problems most of which have solutions in integers and moreover such solutions happens to be infinitely many. Most of the problems in Arithmetica will reduce to a quadratic equation whose solutions can be readily obtained. In this paper, I will introduce a particular linear Diophantine equation for determining date and month of any person born in any year. For this, I had made use of Euclidean Algorithm and elementary algebra.

### Describing the Problem

"You ask any person to think of some date and month of any year of their choice. It may be their date of birth or some special date which is of at most importance. After thinking of the date and month, you ask to multiply the date





### R.Sivaraman

by 12, month by 31 and add these two results. You ask the person to inform the sum and with little calculation in your head, you can quite comfortably determine the correct date and month which is thought of by the person.” How can we be sure enough that our calculation is always correct in computing the required date and month? In this paper, I would provide methods to answer this question and much more.

#### Solving the Problem

If we assume the date and month that the person initially thought of as  $x$  and  $y$  respectively then according to the description of the problem in section 2, we have  $12x + 31y = c$  (1), where  $c$  is a constant representing the final result which you would receive from the person making the computation. Equation (1) is a special type of more general Linear Diophantine Equation of the form  $ax + by = c$  (2), where  $a, b, c$  are constants and  $x, y$  are some integers. It is well known that equation (2) possess infinitely many solutions if the greatest common divisor  $d$  of  $a$  and  $b$  denoted by  $d = (a, b)$  divides  $c$ . Moreover, using Euclidean Division Algorithm we know that there exists integers  $r, s$  such that  $ar + bs = d$  (3). In our case, since the greatest common divisor of 12 and 31 is 1, equation (1) possesses infinitely many solutions. Moreover using (3), we see that there exists integers  $r$  and  $s$  such that  $12r + 31s = 1$  (4). In fact, we note that  $r = 13$  and  $s = -5$  will satisfy (4). I will now prove the following important theorem.

#### Theorem 1

Let  $a, b$  be any two non – zero integers with  $(a, b) = 1$ . Let  $(x_0, y_0)$  be a solution to  $ax + by = c$ . Then all the solutions to  $ax + by = c$  are given by  $x = x_0 - kb, y = y_0 + ka$  (5), for some integer  $k$ .

**Proof:** Since the greatest common divisor of  $a$  and  $b$  is 1, by (3), we see that there exists integers  $r, s$  such that  $ar + bs = 1$ . Hence  $a(rc) + b(sc) = c$ . Thus,  $ax_0 + by_0 = c$  were  $x_0 = rc, y_0 = sc$ .

Now if  $x = x_0 - kb, y = y_0 + ka$  then we have

$$ax + by = a(x_0 - kb) + b(y_0 + ka) = ax_0 + by_0 = c$$

Thus  $x = x_0 - kb, y = y_0 + ka$  is always a solution to  $ax + by = c$  and this completes the proof.

#### Theorem 2

All the solutions to  $12x + 31y = c$  are given by  $x = 13c - 31k, y = -5c + 12k$  (6), for some integer  $k$ .

**Proof:** First, we note that from  $12r + 31s = 1$  we get  $r = 13$  and  $s = -5$ . Using theorem 1, we note that  $x = x_0 - kb = rc - kb = 13c - 31k$  and  $y = y_0 + ka = sc + ka = -5c + 12k$ . For these values of  $x$  and  $y$  and for all integers  $k$ , we have  $12x + 31y = 12(13c - 31k) + 31(-5c + 12k) = c$ .

This completes the proof.

#### Corollary

If  $x, y$  represent date and month of any year respectively then  $x = 13c - 31k, y = -5c + 12k$  will always be a unique solution to  $12x + 31y = c$ .

**Proof:** From theorem 2, we know that  $x = 13c - 31k, y = -5c + 12k$  is always a solution to  $12x + 31y = c$  for any integer  $k$ . To prove uniqueness, we observe that each subsequent value of  $x$  differs by multiple of 31 and each value of  $y$  differs by multiple of 12. Since 31 is the maximum possible date number and 12 is the maximum possible month number, any subsequent solution would exceed these maximum possible range for both  $x$  and  $y$ . Thus the solution to  $12x + 31y = c$  obtained through  $x = 13c - 31k, y = -5c + 12k$  always represent a unique solution.

#### Illustrations

In this section, I will provide few illustrations to explain the results obtained in theorem 2.





### R.Sivaraman

First we note that the minimum value of  $c$  would be 43 corresponding to the day 1<sup>st</sup> January and maximum value of  $c$  would be 744 corresponding to the day 31<sup>st</sup> December.

The following simple procedure can be adopted for finding the value of  $y$  (from which we can find  $x$ ) upon solving the linear Diophantine equation  $12x + 31y = c$ .

1. We should find a number  $\alpha$  such that  $c \equiv \alpha \pmod{12}$ .
2.  $y$  will be the least positive integer such that  $y + 5\alpha$  is divisible by 12.
3. Knowing  $y$ , we can substitute in  $12x + 31y = c$  to get  $x$ .

Now if a person tells you the final result say 428, then  $c = 428$ . Since  $428 \equiv 8 \pmod{12}$ ,  $\alpha = 8$ . Hence we should find least positive integer  $y$  such that  $y + 5\alpha = y + (5 \times 8) = y + 40$  is divisible by 12. Thus  $y = 8$ . Using this in  $12x + 31y = 428$  we immediately obtain  $x = 15$ . Thus the date is 15<sup>th</sup> August, the Independence day of India. As second example, if the final result is 636, then  $c = 636$ . Since  $636 \equiv 0 \pmod{12}$ ,  $\alpha = 0$ . Hence we should find least positive integer  $y$  such that  $y + 5\alpha = y + (5 \times 0) = y$  is divisible by 12. Thus  $y = 12$ . In general if the final result  $c$  is divisible by 12, then  $y$  is always 12. Now substituting  $y = 12$  in the equation we obtain  $x = 22$ . Thus the date is 22<sup>nd</sup> December, the birthday of Srinivasa Ramanujan, celebrated in India as National Mathematics Day. As final example, if the final result is 339, then  $c = 339$ . Since  $339 \equiv 3 \pmod{12}$ ,  $\alpha = 3$ . Hence we should determine least positive integer  $y$  such that  $y + 5\alpha = y + (5 \times 3) = y + 15$  is divisible by 12. Thus  $y = 9$ . Substituting this in we obtain  $x = 5$ . Hence the date is 5<sup>th</sup> September, marking the Teacher's Day in India.

## CONCLUSION

The concept of linear Diophantine equation is introduced and a particular type of such equation of the form  $12x + 31y = c$  is discussed extensively in this paper. I have proved that the general linear Diophantine equations have infinitely many solutions in theorem 1 and through equation (6) of theorem 2, I had obtained infinitely solutions to  $12x + 31y = c$ . In the corollary following theorem 2, I had shown that the solutions represented in (6) of theorem 2 is unique with respect to the restrictions  $1 \leq x \leq 31, 1 \leq y \leq 12$ . Using this unique solution, I have explained a novel scheme for computing date and month. Three practical examples were provided to explain the method in determining date and month. One can alter the coefficients and obtain similar results by forming required linear Diophantine equations. The ideas presented in this paper helps to arrive at such new results.

## REFERENCES

1. Andreescu, T., D. Andrica, and I. Cucurezeanu, An introduction to Diophantine equations: A problem-based approach, Birkhäuser Verlag, New York, 2010.
2. Andrews, G. E. 1971, Number theory, W. B. Saunders Co., Philadelphia, Pa.-London- Toronto, Ont.
3. Isabella G. Bashmakova, Diophantus and Diophantine Equations, The Mathematical Association of America, 1998.
4. Sprindzuk Vladimir G., Classical Diophantine Equations, Springer-Verlag Berlin and Heidelberg GmbH & Company, 1993.
5. Wolfgang M. Schmidt, Diophantine Approximations and Diophantine Equations, Springer; 1996,
6. Yakov I. Perelman Y, Mathematics Can be Fun, Central Books Limited, 1987.
7. R. Sivaraman, Determination of Greatest Common Divisor in  $\mathbb{Z}[\sqrt{2}]$ , International Journal of Development Research, Volume 6, Issue 11, November 2016, pp. 10046 – 10047.
8. R. Sivaraman, Recognizing Ramanujan's House Number Puzzle, German International Journal of Modern Science, 22, November 2021, pp. 25 – 27.







## IOT based Water Quality Monitoring System with Chloro Neutraliser

Maheswari K T<sup>1\*</sup>, Lakshmanan M<sup>2</sup>, Ponmurugan P<sup>3</sup>, Kamatchi Kannan V<sup>4</sup>, Devavikashini A P<sup>5</sup> and Nadin E S<sup>5</sup>

<sup>1</sup>Assistant Professor, Department of EEE, Bannari Amman Institute of Technology, Sathymangalam, Erode, Tamil Nadu, India.

<sup>2</sup>Associate Professor, Department of EEE, CMR Institute of Technology, Bengaluru, Karnataka, India.

<sup>3</sup>Head-R&D, Associate Professor, Department of EEE, Sengunthar Engineering College, Tiruchengode, Tamilnadu, India.

<sup>4</sup>Associate Professor, Department of EEE, Bannari Amman Institute of Technology, Sathymangalam, Erode, Tamil Nadu, India.

<sup>5</sup>UG Student, Department of EEE, Bannari Amman Institute of Technology, Sathymangalam, Erode, Tamil Nadu, India.

Received: 22 Dec 2021

Revised: 31 Dec 2021

Accepted: 13 Jan 2022

### \*Address for Correspondence

#### Maheswari K T

Assistant Professor,

Department of EEE,

Bannari Amman Institute of Technology,

Sathymangalam, Erode, Tamil Nadu, India.

Email: maheswarikt@gmail.com



This is an Open Access Journal / article distributed under the terms of the **Creative Commons Attribution License** (CC BY-NC-ND 3.0) which permits unrestricted use, distribution, and reproduction in any medium, provided the original work is properly cited. All rights reserved.

### ABSTRACT

Water is a necessary component for humanity's survival. Because of its numerous applications, it is always in high demand. Large reservoirs of water, such as lakes, streams, and the ocean itself, provide the majority of the water supply. As a result, it's a good idea to keep an eye on things to confirm that it is fit for human consumption. Water quality monitoring is now done in traditional labs, which is time intensive and prone to errors. As a result, the goal of this article is to see if an Arduino-based sensor system for water quality monitoring is feasible. Weekly onsite tests at several daily locations were conducted using a simple prototype consisting of a microcontroller and multiple attached sensors. The system was discovered to be reliable, however it is reliant on human intervention and disposed to data mistakes. The system, on the other hand, lays a solid foundation for future growth activities in the same category, elevating the system to a higher level in Internet of Things (IoT) compatibility.

**Keywords:** Arduino UNO R3 board, Inline pH probe Sensor, Mineral Cartridge, Notification System, Smart Home.





## INTRODUCTION

Freshwater is a natural resource that is vital for agriculture, industries, and human survival on the earth. Currently, drinking water utilities are confronted with new challenges [1-2]. The quality of water available for the use of humans has suggestively depreciated due to controlled drinking water deliveries, rigorous currency requirements, expanding residents, urbanisation in villages, and the extreme utilization of sea wealth for extraction of salt [3-4]. Chemicals in textile, construction, and other factories, as well as pesticides in farms and the direct discharge of contaminated water from industry into surrounding water bodies, have all contributed significantly to the universal water quality deprivation, which has become a major issue [5].

Even as a result of containment water, various water born is rising day by day, resulting in the deaths of many people. In the recent days, a large amount of population in India is affected with diseases such as diarrhoea, cholera, dysentery, typhoid, and polio. Over few years later, the safety of water conditions to bodily health has become an order of business that has attracted the curiosity of everyone who is concerned about chronic illness spread by drinking water. Disinfection is necessary in the process of water treatment. This is due to pure water that somehow gets mixed with the industrial wastes, artificial colours, wastes due to the breakage of pipes and disproper filtrations. Disinfection is considered to substantially harm illness germs. Conventionally, the quality identification of water was done physically, through which the water samples are being collected and given to the research laboratories for investigation, which requires more money, human resources and also time consuming [6-7]. Also, these methods cannot provide actual data. There are a variety of water disinfection technologies available. So the proposed system would minimize these affects and prevent people from suffering to these kind of diseases and live healthily [8-9]. In this paper section 1 gives the introduction on need for water quality monitoring system, and the sources of water contamination, Section 2 represents the disadvantages of using reverse osmosis system in home, Section 3 provides the importance of proposed system, section 4 and 5 gives the hardware description of the components used as well as the working model of the proposed system, finally section 6 presents the conclusion of the paper.

## LITERATURE REVIEW

Lambrou et al. (2014) presented the consistent water level control system which is portable, mobile and cost effective [10]. In this paper the two radio frequency receivers and a transmitter is fixed in the tank which stores the quality of water wanted to be checked. Various parameters like pH, Temperature are measured using the sensor array and the cost of the system has been reduced as the wireless system is implemented. Prasad et al. (2015) has shown the smart and IOT based device for water quality monitoring for Fiji [11]. In the island of Fiji it is necessary to analyse the collected water sample data regularly for observing the quality of water and export the data to the server. To meet this requirement, the remote sensing and IOT based technologies are implemented in the system. Also, GSM module is used to send the information to the user using SMS. Omar et al. (2017) provides a microcontroller based water quality scheme for people living in and around Bangladesh who is not having drinking water facility [12]. The device is using sensors to measure the constraints of water such as temperature, turbidity and hydrogen potential. Based on the preset value the measured value is compared and the error is calculated. Mahaboob Basha et. al, has planned a real time water observing system at consumer location. Arm7 processor and Zigbee module is used signal conditioning, computing and transformation of data[13-14].

Neil Andre C. et al. (2016) has implemented a monitoring system for water which notifies the water parameters to the users. The physical and chemical constraints such as temperature, conductivity, pH flow and ORP has been measured using sensors and "the information is passed using Zigbee arrangements. "An audio alert will be provided if the parameters are exceeding the preset value [15-17].



**Maheswari et al.,****DISADVANTAGES OF RO SYSTEM IN HOME**

There is now enough evidence to confirm the negative health effects of consuming calcium or magnesium-deficient water. The important minerals such as zinc, iron, copper, calcium, iodine, phosphorus, fluoride and magnesium are filtered out during the RO membrane filtration process by which all gets purified and the water we drink does not contain any minerals. This is the reason behind the reduction of essential minerals which is necessary in our daily routine to maintain body health. This would be a threat for high blood pressure and atherosclerosis, peptic ulcers, prolonged gastritis, diffuse hyperplasia of the thyroid, complications during pregnancy and numerous difficulties in new – borns and infants, including icterus, tired blood, fractures and growth disorders. Drinking water with low TDS (Total Dissolved Salts), has an adverse effect on our body's homeostasis. Consuming RO demineralized water causes severe symptoms such as headaches, overtiredness, and weakness, as well as muscle contractions and a reduced heart rate, a detrimental impact on hormone secretion, function of kidney, and bone mineral density. Fig. 1 shows a RO Purifier.

**PROPOSED SYSTEM**

While drinking upon the water there are most microorganisms that are mixed not visible to our eyes and due to the impurities that have been mixed the PH level of the water gets lesser, making more likely to be contaminated with pollutants and making it unsafe to drink. Fig.2 shows the picture of contaminated water. In this proposed system, a special technique is used that would purify the water before it is transferred to the tank where the drinking water is stored. Here, a PH sensor is placed to sense the PH level of the water before the water from municipalities or corporation reaches the water tank. The water's pH level is detected continuously and if the water is more contaminated obviously the pH level is lesser than the neutral pH of drinking water. Under this condition, the pH level is indicated and the flowing of water is suddenly blocked by closing the two valves at the end through the IOT device. Additionally, chloramine gas is stored in the nearest tank. When less pH level is detected, immediately the chloramine which is situated external to the pipe is allowed to flow through the pipe and sprinkled to the water until the pH level of the water gets into the normal level. After the pH of the water becomes neutral to the drinking level the pathway of the water differs. There a new passage opens and the water flows to the mineral cartridges and the water is then transferred to the water tanks where it gets stored to drink safely.

**HARDWARE DESCRIPTION****INLINE PH PROBE SENSOR**

For difficult water and waste water applications, this inline pH probe sensor is recommended. It employs a direct 4-20mA analogue or MODBUS/RS485 digital output signal to connect to a PLC or any other control system. Sensor adjustments can be made quickly and without the need of any tools. Cable and mounting hardware are reusable. Fig. 3 shows the picture of inline pH probe sensor.

**ARDUINO UNO R3 BOARD**

A total of 6 analog input pins labelled A0 to A5 to allow up to a maximum of 6 analog sensors to connect directly to the Arduino. Fig.4 shows the Arduino Uno R3 board. A total of 2 power supplies pin labelled 3.3 volts and 5 volts with in-built voltage regulation to provide power to sensors. A USB plug that can be used in conjunction with a USB cable to connect with a microprocessor.

**CHLOROAMINE GAS HOLDER**

Chloramine levels of drinking water is permitted up to 4 milligrammes per litre (mg/L) or 4 parts per million (ppm). At these attentions, serious health effects are unlikely. Fig. 5 shows the chloramine gas holder used in the proposed system.

**MINERAL CARTRIDGES**

Mineral Cartridges as shown in Fig.6, works by forming little water clusters, which gives water more energy. The fuction is to add minerals and maintains a pH equilibrium that is optimal. Calcium is added to the water. Acts to

38222



**Maheswari et al.,**

remove ions that are hazardous to the environment and cause water contamination.

**WORKING MODEL**

"When the water arrives to the tank the pH of the water is detected by a pH detector and checks whether the water is contaminated or not . If it is contaminated". then the arduino closes the valve present one meter apart from the tank inlet then the microcontroller opens the chloramine gas tube which is present near the closed valve . Then the valve opens to certain diameter until the water and chloramine gas mixes up and finally the water is uncontaminated . The contaminants settles down and the pure water is used for domestic purpose. Then a new path opens up which is controlled by Arduino and the water is transferred to the mineral gauge for enrichment of minerals and irons. This method is extremely different from reverse osmosis , because in RO the water is fully purified by minerals and taste materials are added and also it doesn't contains any required elements for good health. But in the proposed system the water is only decontaminated that is mixed up with contaminants. When there is a high contamination level the information is tweeted as a message to corporation to take severe actions in that area to prevent people from various kind of diseases. The Fig.7 shows the working model of chloroneutralizer.

Five water samples are collected from different sources and tested in the proposed system. Table 1 gives the results observed from the various samples. From the figure it is observed that over 80% of the measured water tests were passed the suggested the pH go. Hence, a special techniques is used to neutralize the chlorine with chloroamine gas.

**CONCLUSION**

By utilising the proposed technology the wide spread of many water based diseases can be prevented. Also, this system will be more effective if implemented in every houses. The decontamination will be already done in the main storage tanks in corporations but the major contamination occurs in the pipes present between the source and sink Hence, with the help of the proposed system the people can live in disease free environment which is caused through water .

**REFERENCES**

1. Uferah Shafi, Rafia Mumtaz, Hirra Anwar, Ali Mustafa Oamar, Hamza Khurshid, "Surface Water Pollution Detection using Internet of Things", IEEE Conference Proceedings, pp.92-96,2018.
2. Baihaqi Siregar, Krisna Menen, Syahril Efendi, Ulfi Andayani, "Monitoring Quality Standard of Waste Water using Wireless Sensor Network Technology for Smart Environment", The International Conference on ICT for Smart Society (ICISS),pp.1-5,2017.
3. Yiheng Chen, Dawei Han," Water quality monitoring in smart city: A pilot project", International Journal of Automation in Construction, Vol.89, pp.307-316,2018.
4. Fanlin Meng, Guangtao Fu,and David Butler, "Cost-Effective River Water Quality Management using Integrated Real-Time Control Technology", Environmental Science and Technology,Vol. 51, 9876-9886,2017.
5. Niel Andre Cloete, Reza Malekian, and Lakshmi Nair, "Design of Smart Sensors for Real-Time Water Quality Monitoring" , Journal of Latex class files, Vol. 13, no. 9,pp.1-16, 2014.
6. Brinda Das, P.C. Jain, "Real-Time Water Quality Monitoring System using Internet of Things", 2017 International Conference on Computer, Communications and Electronics (Comptelix), Manipal University Jaipur, pp.78-83,2017.
7. Dong He,Li-Xin Zhang, "The Water Quality Monitoring System Based on WSN", IEEE Conference Proceedings, pp.3661-3664,2012.
8. Tha. Sugapriyaa, S. Rakshaya, K. Ramyadevi,M.Ramya, P.G.Rashmi, "Smart Water Quality Monitoring System For Real Time Applications", International Journal of Pure and Applied Mathematics, Vol. 118, No. 20, pp. 1363-1369,2018.
9. M N Barabde, S R Danve, "Continuous Water Quality Monitoring System for Water Resources at Remote Places",





**Maheswari et al.,**

International Journal of Engineering Research and General Science, Vol. 3, no. 3, 2015.

10. P. Lambrou, Christos C. Anastasiou, Christos G. Panayiotou, and Marios M. Polycarpou, "A Low-Cost Sensor Network for Real-Time Monitoring and Contamination Detection in Drinking Water Distribution Systems" , IEEE Sensors Journal, Vol. 14, no. 8, 2014.
11. A.N.Prasad, K. A. Mamun, F. R. Islam, H. Haqva, "Smart Water Quality Monitoring System", IEEE Conference Proceedings, pp. 1-5,2014.
12. Md. Omar Faruq, Injamamul Hoque Emu, Md. Nazmul Haque, Maitry Dey, N. K. Das and Mrinmoy Dey, "Design and Implementation of Cost Effective Water Quality Evaluation System", 2017 IEEE Region 10 Humanitarian Technology Conference (R10-HTC),pp.21 – 23, 2017.
13. Gayathri S Menon, Maneesha Vinodini Ramesh, Divya P, "A Low Cost Wireless Sensor Network for Water Quality Monitoring in Natural Water Bodies", IEEE Conference Proceedings, pp. 1-5,2017.
14. Muhammad Azwan Nasirudin, Umami Nurulhaiza Za'bah and O.Sidek, "Fresh Water Real-Time Monitoring System Based on Wireless Sensor Network and GSM", 2011 IEEE Conference on Open Systems (ICOS2011), pp.354-358, 2011.
15. Gurkan Tuna, Orhan Arkoc, and Kayhan Gulez, "Continuous Monitoring of Water Quality Using Portable and Low-Cost Approaches", International Journal of Distributed Sensor Networks, Article ID 249598,pp.1- 11, 2013.
16. John Hall, Alan D. Zaffiro, Randall B. Marx, Paul C. Kefauver, E. Radha Krishnan, Roy C. Haight, and Jonathan G. Herrmann, "On-line Water Quality Parameters as Indicators of Distribution System Contamination", Journal - American Water Works Association,pp.1-10, 2014.
17. Sathish Pasika, Sai Teja Gandla, "Smart water quality monitoring system with cost-effective using IoT", Heliyon, Vol.6,pp.1-9,2020.

**Table 1. Tested Samples and Results Observed**

S.No	Water Sample	Temperature	Measured pH	Output
1	Sample 1	26.43	8.2	Drinkable
2	Sample 2	27.36	8.1	Drinkable
3	Sample 3	23.54	9.1	Not Drinkable
4	Sample 4	22.23	9	Not Drinkable
5	Sample 5	23.78	9.3	Not Drinkable



**Fig 1. RO purifier**



**Fig 2. Contaminated waters**





Maheswari et al.,



Fig 3. Inline pH probe sensor

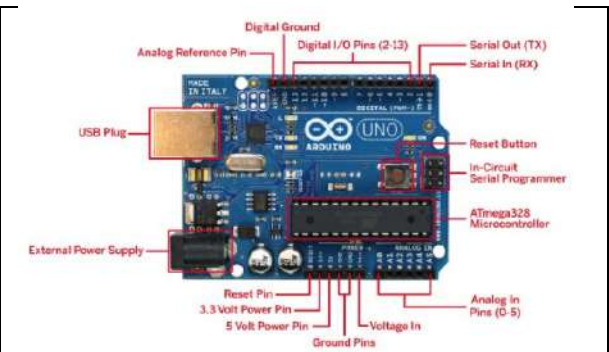


Fig 4. Arduino UNO R3 board

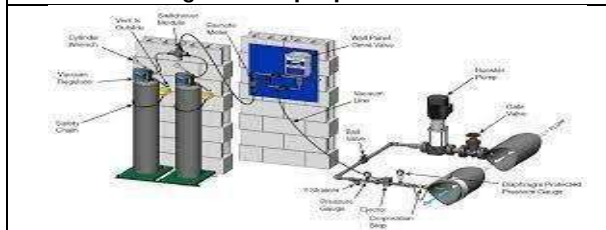


Fig 5: Chloramine gas holder

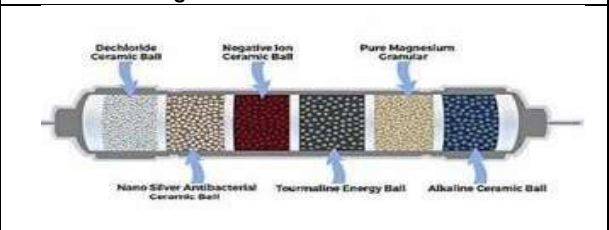


Fig 6. Mineral cartridges

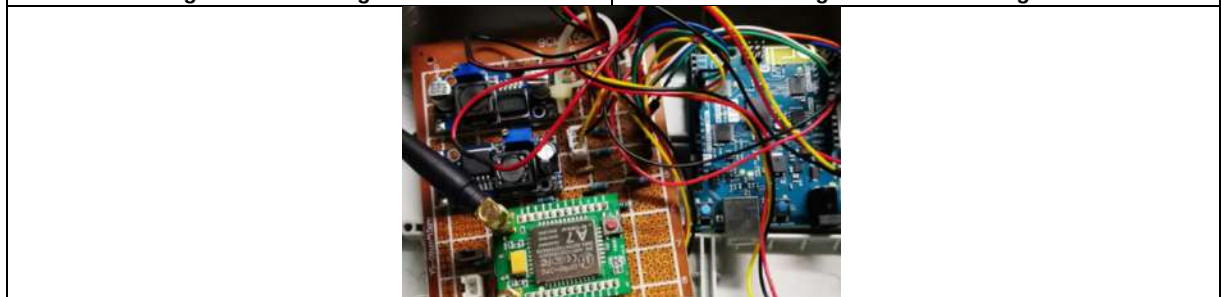


Fig:7 Hardware Set up of the Proposed System





## A Review on Covid-19 Detection using Deep Learning Approaches

S.Deepika<sup>1\*</sup> and M.Rajeswari<sup>2</sup>

<sup>1</sup>Research Scholar, Department of Computer Science, PSGR Krishnammal College for Women, Coimbatore, Tamil Nadu, India.

<sup>3</sup>Assistant Professor, Department of Computer Science, PSGR Krishnammal College for Women, Coimbatore, Tamil Nadu, India.

Received: 12 Nov 2021

Revised: 21 Dec 2021

Accepted: 11 Jan 2022

### \*Address for Correspondence

**S.Deepika**

Research Scholar,  
Department of Computer Science,  
PSGR Krishnammal College for Women,  
Coimbatore, Tamil Nadu, India.  
E.Mail; deepikasriselvam@gmail.com



This is an Open Access Journal / article distributed under the terms of the **Creative Commons Attribution License** (CC BY-NC-ND 3.0) which permits unrestricted use, distribution, and reproduction in any medium, provided the original work is properly cited. All rights reserved.

### ABSTRACT

The World Health Organization (WHO) has proclaimed the new corona virus 2019 (COVID-19) epidemic as a Global Public Health Crisis. Several COVID-19 outbreak models are being utilised by researchers all over the world to help them make informed decisions and implement critical control measures. Among the established strategies for COVID-19 worldwide pandemic prediction, simple statistical and epidemiological methods have grabbed the interest of academics and authorities. The COVID-19 detection in CT and X-ray imaging is critical for detection, therapy, and evaluation. But still, radiologists have a predictable challenge when dealing with analytical uncertainty in a medical report. In this case, Deep learning (DL) has an advanced application in detecting and preventing the growth of COVID-19 instance. It is capable of identifying and detecting patterns in huge and complicated datasets which have been recognised as a suitable method for analysing COVID-19 infected patients. A survey of several DL approaches used to detect COVID-19 cases is described in this article. In addition, their benefits and drawbacks are discussed in a tabular form. Finally, an entire survey is summarized and future directions are suggested to increase the efficiency of DL models in order to provide valuable solutions for COVID-19 cases.

**Keywords:** Public Health Crisis, COVID-19 Cases, Medical report, Deep Learning, Analytical Uncertainty





Deepika and Rajeswari

## INTRODUCTION

In 2019, a fatal pneumonia caused by the Severe Acute Respiratory Syndrome Coronavirus 2 (SARS-CoV-2) was found in Wuhan, China, and quickly spreaded all around the world. In general, the resulting condition was termed as COVID-19. COVID-19 causes a wide range of clinical symptoms, including fever, cough, dyspnea,

fatigue, myalgia, headache, and intestinal difficulties [1], allowing the disease to spread easily through contact with an infected person. As a result, it is critical to identify and isolate afflicted individuals as soon as possible in order to prevent the virus from spreading further. The infection of COVID-19 disease is conducted through Reverse transcription polymerase chain reaction (RT-PCR). It is the process of collecting samples from a person's body where the COVID-19 is most likely to obtain, such as the nose or throat. Then, the collected sample is treated with chemicals to track down the existence of the COVID-19 [2]. Though RT-PCR can distinctly identify COVID-19 diseases but in many regions of the world. RT-PCR's availability is limited. As a result, medical imaging like CT and X-Ray images, can be a feasible alternative approach for detecting COVID-19 which is utilized to generate medical images in the majority of medical facilities and hospitals (reports). Also, these images are readily available and relatively easy to handle with less computational time and cost. Where, RT-PCR is expensive and consumes a considerable amount of time for the identification. Clinical radiologists may occasionally experience difficulty in interpreting the results of these imaging modalities, resulting in worse accuracy performance [3]. In recent days, Doctors and researchers are interested in using artificial intelligence (AI) to handle the COVID-19 outbreak effectively [4]. AI is capable of accurately spotting unusual patterns in CT and X-ray images. This method enables the analysis of certain segment regions and the capturing of specific features in chest CT images, which helps with diagnosis. COVID-19 has been detected using AI techniques and differentiates it from other pulmonary illnesses including community-acquired pneumonia [5]. The DL is a distinct field that is critical for detecting various aspects of the COVID-19 outbreak. DL approaches have been widely applied in a number of applications such as classification, prediction issues, and so on, because of their increased flexibility to numerous data types across multiple domains. This method also improves the speed with which complex medical images are analyzed for illness diagnosis [6]. DL models are widely utilized in the health care area for broad data interpretation, assisting in disease early detection, and reducing manual labour. DL techniques are typically classified into distinct groups using their network structure. Unsupervised pre-learned models, recurrent, recursive, and Convolutional Neural Networks (CNNs) are among the classifications. CNN is a well-known model in several categories, with the purpose of learning medical image patterns and characteristics for categorising all types of diseases. A more effective learning strategy is to use pre-trained CNNs to classify the improved clinical images. These network models are trained on millions of images and then used to predict new image categories. There are various pre-trained CNN structures available nowadays, such as VGG Net and Res Net has enhanced to solve an issue by fast learning the relevant parameter. The remaining section of this article is structured as Section 2 provides the survey of several DL approaches for the detection COVID-19 cases. Section 3 presents the comparative their benefits and drawbacks. Section IV concludes the survey and suggests the future enhancements.

### Survey on Deep Learning Techniques Based Covid-19 Detection

A deep learner with voting-based approach and cross-dataset analysis was developed [7] to detect COVID-19 instances using the images from CT scans. Initially, simple pixel intensity regularization was used to resize the input samples. Then, data augmentation was achieved based on rotation, horizontal flip and scaling. Moreover, these samples were given to the efficient Net classifier which uses a voting-based mechanism for classification. But, the accurateness was still not efficient. Using deep learner techniques, the CT samples were detected and categorised [8] as COVID-19, Pneumonia, and healthy. At first, the CT samples were pre-processed to extract the lung regions. After that, 3D-CNN was employed to partition samples into multiple patches and categorized them into 3 different types. But, it was not able to identify the diseases quickly and has low performance results. A Deep Transfer Learning (TL) framework has been designed [9] to speedup the identification of COVID-19 persons from X-ray and chest CT scans. It has been employed for mining the characteristics from the COVID-19 scans and learning them to differentiate pneumonia, other lung disorders and healthy cases. Also, a color visualization method was applied by the Grad-





**Deepika and Rajeswari**

CAM method to obtain the ROIs of diseased pulmonary lesions. However, it was not able to train temporal dependence features for avoiding false positives. A light CNN model has been designed [10] depending on the structure of the Squeeze Net for effectively distinguishing COVID-19 CT scans regarding other pneumonia and healthy CT scans. In this model, the hyper-parameters were optimized by the Bayesian optimization scheme to achieve better learning. But, it needs efficient feature selection and segmentation methods for improving the classification efficiency.

A 2D sparse matrix profile method has been designed [11] for identifying COVID-19 from lung CT scans. At the 1D stage, CT images was flatted and converted to the 1D vector. At the 2D stage, a matrix profile was computed in a sliding window for each segment in the image. Then, An infection severity value was calculated, and the difference between such severities in COVID-19 and non-COVID-19 CT images was studied. After, the infection-weighted scans were fed to the Dense Net for training and differentiating the CT images of COVID-19 and non-COVID-19. But, its efficiency depends on the amount of Dense Net layers and CT scans. A weakly-supervised deep learner has been developed [12] to automatically identify and categorize COVID-19 disease from CT scans. First, the CT lung scans were collected and a multi-view U-Net-based partition network was applied to segment the scans. For each segment, CNN was used to identify and categorize the infected CT scans and healthy scans. Then, multi-scale training was adopted to locate the lesions by computing the class score maps. But, its performance was not highly effective. An automated system has been designed [13] using DCNN for identifying the COVID-19 from pulmonary X-ray scans. Different pre-learned structures such as ResNet50, InceptionV3, and Inception-ResNetV2 were used in this method to improve detection accuracy. The chest X-ray images were categorised into various kinds of illnesses by training these models, including ARDS, COVID-19, MERS, pneumonia, and SARS. However, it was only performed on a small number of X-ray samples, which may have influenced the accuracy. A DL network called Coro Net has been designed [14] for recognizing and diagnosing COVID-19 from pulmonary X-ray scans. At first, The X-ray scans were gathered, and the images were resized. Then, Coro Net was developed to discover many types of pneumonia, including bacterial, viral, and COVID-19. Though it achieves better accuracy and computationally less expensive, it considers only a limited amount of images for training. Also, it needs to effectively diagnose the COVID-19 depending on infected pulmonary tissues detection using CT scans.

A rapid and efficient procedure has been presented [15] to recognize COVID-19 patients with multi-task deep learner. In this method, X-ray and CT scans were considered. Also, inception residual recurrent CNN along TL was employed to detect the COVID-19 cases. But, it uses only less quantity of data for training and testing. Also, few false positives were found because of the scarcity of the labeled samples. Detail-Oriented Capsule Networks (DECAPS) were designed [16] to automatically diagnose COVID-19 from CT scans. Initially, an inverted dynamic routing strategy was utilised to improve model stability by excluding data from non-descriptive areas from entering the model. Then, a Peek aboo learning process was applied which utilizes a 2-step patch crop and drop policy for focusing on ROIs. After that, the data's coarse and fine-grained representations were combined. Moreover, a scan enrichment scheme based on the conditional Generative Adversarial Network (GAN) was used to extend the learning scans. Though it uses GAN, still it needs a large-scale dataset to increase the classification accuracy An automated technique was designed [17] to prognose COVID-19 from X-ray scans. This technique was depending on the Xception Net which utilizes depth-wise separable convolutions. First, the X-ray scans were collected from various sources and visualized by using exploratory data analysis. Then, the image regularization was used to transform the images into the array and remove the distortions from the images. After, the DNN was applied to learn the training samples. Moreover, image augmentation was performed and the augmented images were given to the CNN for predicting COVID-19, severe pneumonia and healthy patients. Still, it needs a vast amount of image samples for increasing the classification accuracy. COVID-19 from X-ray scans has been investigated [18] using an automated technique. It was carried out using the Xception Net and ResNet50V2 structures in conjunction. It was performed depending on the combination of Xception Net and ResNet50V2 structures. Multiple features were retrieved from lung X-ray scans using this approach to accurately identify COVID-19 and pneumonia patients. But, it uses a very less quantity of data for learning. CovX Net has been designed [19] which uses CNN with depth-wise convolution to accurately extract different attributes from lung X-rays. First, a large number of pulmonary X-rays



**Deepika and Rajeswari**

from healthy and pneumonia patients were considered for learning CovX Net. The primary learning was passed on to a few further optimising layers, which were obtained using fewer lung X-rays related to COVID-19 and another pneumonia patient. Further, a gradient-based discriminative localization has been combined for differentiating the irregular areas of X-ray samples indicating various categories of pneumonia. But, it has less accuracy while detecting all types of COVID-19 Pneumonia. The COVID-19 from X-ray scans has been detected [20] using an ensemble classifier. In this model, pre-trained ResNet50 and VGG-16 networks were combined wherein the max-pooling was applied to reduce the feature dimensionality. Also, it was utilized to categorize the COVID-19 and pneumonia patients from pulmonary X-rays. But, it cannot learn temporal dependence data to further reduce the false positives. A Novel method called COVID-SD Net has been designed [21] with the maximum generalization ability to categorize COVID-19 from lung X-ray scans. First, The COVIDGR-1.0 dataset was acquired, and the incorrect data from the input X-ray images was removed using a pre-processing method called segmentation-based cropping. Also, a class-inherent transformation scheme was applied for increasing the discrimination ability. After, a novel inference task was developed which combines the detection of different transformed classes for computing the resultant prediction. Further, the COVID-SD Net was applied for categorizing the COVID-19 persons. However, it needs to utilize extra clinical information together with lung X-ray scans to increase efficiency.

A powerful CNN has been developed [22] with an adapted pre-learned Alex Net structure to recognize COVID-19 from X-ray and CT scans. Even if it achieves high accuracy, it does not indicate a robust solution particularly with the limited amount of images. In addition, the essential properties of diseases must be used to compensate for the model's efficiency. For detecting the COVID-19 cases, an new approach has been designed [23] using three phases: i) The initial phase was utilised to detect the presence of pneumonia, ii) the next phase was used to distinguish COVID-19 from pneumonia. iii) The third step was utilised to localise the regions in the X-ray that were indicative of the presence of COVID-19. But, this system needs to improve the training performance on massive datasets. COVID-Net has been suggested [24] which was a DCNN structure tailored for identifying the COVID-19 persons from lung X-ray scans. Also, a free-access benchmark dataset comprised of lung radiography images was generated by combining and altering data from various open-access data repositories. However, its robustness was not effective since it may fail for categorizing all COVID-19 positive persons. A deep learner system [25] has been developed for detecting and diagnosing COVID-19 from X-ray and CT scans of the lungs. Initially, a comparatively huge COVID-19 dataset was collected. Then, deep TL was used for identifying the abnormal samples. Also, three pre-trained CNNs structures were fine-tuned on the training samples: DenseNet121, NAS Net-Large and NAS Net-Mobile. Still, the dataset was not sufficient to achieve better performance.

An alternative structure was developed and relied [26] on Capsule Networks called COVID-CAPS for identifying COVID-19. This model was comprised with many capsule and convolutional layers. Also, the loss factor was changed for solving the class-imbalance challenge. But, it needs to alter the model and enhance the efficiency while applying a new data set. A multi-class and hierarchical categorization has been developed [27] to recognize COVID-19 in lung X-ray scans. First, the lung X-ray scans were gathered and an automated pre-processing was performed to standardize the images. Then, texture descriptors were applied to extract both handcrafted and non-handcrafted features from the X-ray samples. After, these features were fused and re sampling was processed to solve the class-imbalance challenge. Moreover, these features were classified by various machine learning classifiers include KNN, random forest, SVM, decision tree and MLP for recognizing COVID-19 samples. But, it has very poor performance compared to DL algorithms.

Using multiple processes such as pre-processing, feature selection, and categorization, the COVID-19 has been predicted [28] from CT samples. Initially, the appropriate COVID-19 features were recovered from these ROIs after a CT sample was pre-processed to partition the ROI. Following that, a TL neural network was used to classify characteristics like Pneumonia and COVID-19. But, its efficiency was less since the training sample size was small. Also, the efficiency was affected by many factors like low signal-to-noise and feature aggregation. A deep uncertainty-aware TL technique was developed [29] for accurate detection of COVID-19 patients from X-ray and CT images. Initially, pre-trained CNN models like VGG16, DenseNet121, InceptinResNetV2, and ResNet50 were first



**Deepika and Rajeswari**

used to extract deep features from X-ray and CT images of the chest. The images were then analysed using a variety of machine learning and statistical modelling techniques to detect COVID-19 cases. Finally, the epistemic uncertainty was calculated to identify the locations where the training model was unsure of its conclusions. However, no algorithm has reached a strong consensus on the anticipated labels of such samples. A deep learning-based chest radiograph classification (DL-CRC) was presented [30] to accurately distinguish COVID-19 cases from other abnormal (e.g., pneumonia) and normal cases. This strategy combines the GAN and generic data augmentation methods to generate synthetic COVID-19 infected chest X-ray pictures in order to develop a robust model for the COVID-19 data using a data augmentation of radiograph images (DARI) algorithm. Actual and synthetic chest X-ray images were given into the developed CNN model in DL-CRC from training data to improve COVID-19 detection efficiency. This model was unable to classify the various stages of COVID-19 due to a lack of labelled data. An iteratively pruned DL model was created [31] to detect COVID-19 pulmonary symptoms using chest X-rays (CXR). A modified CNN and a range of Image Net pre-trained systems were trained on publically available CXR collections to generate modality-specific feature representations. In order to increase performance and generalization, the collected data was transferred and fine-tuned in the related task to recognize CXRs as normal or COVID19 virus. Sometimes, it should be pruned efficiently to reduce the computational burdens

An evidential Covid-Net model was proposed [32] to detect the Covid-19 automatically. In this system, the Neural Network (NN) layout was utilized to detect the Covid-19 from CT images which composed of a CNN for feature extraction and a belief function-based classification module. Then, an evidential NN classifier maps image features into mass operations to enhance the prediction of COVID-19 cases. Finally, a semi-supervised training algorithm was devised to train the system with partial annotations. Comparatively, this model does not provide accurate results than other existing models. Deep learning-based approaches were presented [33] to diagnose and identify the COVID-19 patients by using X-Ray images of lungs. The algorithms such as deep NN were utilized on the fractal feature of photos and CNN on the X-ray lung images to overcome the diagnosis problem. The first method was consists of classification and feature selection using ANN and fractal methods. Second, classical CNN methods were analyzed to solve the detection problems. Finally, CNN-based segmentation algorithms were presented to differentiate infected tissue using Lung MRI scans. However, this method was expensive and time-consuming.

COVID-19 was diagnosed [34] automatically from X-ray images using a deep CNN-LSTM network. In this method, a CNN was deployed to extract complex characteristics from images, and an LSTM network was employed as a classifier to identify the COVID-19 using those extracted features. The performance was improved by integrating selected features with LSTM to differentiate COVID-19 cases from others. As a result, the sample size in this model was quite little, and it has to be increased in order to assess the model's generaliz ability. A Parallel-Dilated COVID Net (PDCOVID Net) was introduced [35] to increase the COVID-19 detection approach employing chest x-ray images. At first, a dilated convolution in the parallel stack of convolutional blocks was used to capture and propagate important data in parallel over the network. The X-ray images were then analyzed to determine the inaccurate classification by comparing COVID and non-COVID cases. Finally, the gradients were computed for a particular image and connected to feature maps of the last CNN layer for constructing a class-discriminative region. However, this method fails to identify key regions due to heat map emphasizes outside X-ray rather than inside the lung

**COMPARATIVE STUDY**

In this part, Table 1 presents a comparison evaluation of the benefits and limitations of DL-based COVID-19 detection strategies, which are briefly discussed in the previous section.

**CONCLUSION**

This paper provides a detailed study on recently developed DL USING COVID-19 detection techniques are presented with their benefits and drawbacks. As previously indicated, COVID-19 diagnostics employing DL





### Deepika and Rajeswari

approaches with the least expense and consequences are the most basic measures in preventing the infection and the progression of this pandemic disaster. In the near future, it will be feasible to identify this condition faster, cheaper, and safer by incorporating DL approaches into radiology centre equipment. The application of these COVID-19 rapid diagnostic decision-making procedures can be a beneficial tool for radiologists in decreasing human errors and supporting them in making decisions in critical conditions and at the peak of the disease. This study supports the concept that deep learning algorithms are a potential tool for improving healthcare, diagnostic, and therapeutic outcomes.

## REFERENCES

1. Ghafouri-Fard, S., Noroozi, R., Vafaei, R., Branicki, W., Pošpiech, E., Pyrc, K., .. & Sanak, M. (2020). Effects of host genetic variations on response to, susceptibility and severity of respiratory infections. *Biomedicine & Pharmacotherapy*, 128, 110296.
2. Smyrlaki, I., Ekman, M., Lentini, A., de Sousa, N. R., Papanicolaou, N., Vondracek, M., ... & Reinius, B. (2020). Massive and rapid COVID-19 testing is feasible by extraction-free SARS-CoV-2 RT-PCR. *Nature communications*, 11(1), 1-12.
3. Bai HX, Hsieh B, Xiong Z, Halsey K, Choi JW, Tran TML, et al. Performance of radiologists in differentiating COVID-19 from viral pneumonia on chest CT. *Radiology*. (2020) 296:1–8. doi: 10.1148/radiol.20200823
4. Ozsahin I, Sekeroglu B, Musa MS, Mustapha MT, Uzun Ozsahin D. Review on diagnosis of COVID-19 from chest CT images using artificial intelligence. *Comput Math Methods Med*. (2020) 2020:1–10. doi: 10.1155/2020/9756518
5. Li L, Qin L, Xu Z, Yin Y, Wang X, Kong B, et al. Using artificial intelligence to detect COVID-19 and community-acquired pneumonia based on pulmonary CT: evaluation of the diagnostic accuracy. *Radiology*. (2020) 296:E65–71. doi: 10.1148/radiol.20200905.
6. X. Xu, X. Jiang, C. Ma, P. Du, X. Li, S. Lv, L. Yu, Q. Ni, Y. Chen, J. Su et al., "A deep learning system to screen novel coronavirus disease 2019 pneumonia," *Engineering*, 2020.
7. da Silva, J. A. T. (2020). Convalescent plasma: a possible treatment of COVID-19 in India. *Medical Journal, Armed Forces India*, 76(2): 236-237.
8. Butt, C., Gill, J., Chun, D. and Babu, B. A. (2020). Deep learning system to screen coronavirus disease 2019 pneumonia. *Applied Intelligence*, 1-7.
9. Panwar, H., Gupta, P. K., Siddiqui, M. K., Morales-Menendez, R., Bhardwaj, P. and Singh, V. (2020a). A deep learning and grad-CAM based color visualization approach for fast detection of COVID-19 cases using chest X-ray and CT-scan images. *Chaos, Solitons & Fractals*, 140: 1-12.
10. Polsinelli, M., Cinque, L. and Placidi, G. (2020). A light CNN for detecting covid-19 from CT scans of the chest. *Pattern Recognition Letters*, 140: 95-100.
11. Liu, Q., Leung, C. K. and Hu, P. (2020). A two-dimensional sparse matrix profile DenseNet for covid-19 diagnosis using chest CT images. *IEEE Access*, 8: 213718-213728.
12. Hu, S., Gao, Y., Niu, Z., Jiang, Y., Li, L., Xiao, X., ... & Yang, G. (2020). Weakly supervised deep learning for covid-19 infection detection and classification from ct images. *IEEE Access*, 8, 118869-118883.
13. Narin, A., Kaya, C. and Pamuk, Z. (2020). Automatic detection of coronavirus disease (covid-19) using x-ray images and deep convolutional neural networks. *arXiv preprint arXiv:2003.10849*, 1-31.
14. Khan, A. I., Shah, J. L. and Bhat, M. M. (2020). Coronet: a deep neural network for detection and diagnosis of COVID-19 from chest x-ray images. *Computer Methods and Programs in Biomedicine*, 196: 1-9.
15. Alom, M. Z., Rahman, M. M., Nasrin, M. S., Taha, T. M. and Asari, V. K. (2020). Covid\_mtnet: Covid-19 detection with multi-task deep learning approaches. *arXiv preprint arXiv:2004.03747*, 1-12
16. Mobiny, A., Cicalese, P. A., Zare, S., Yuan, P., Abavisani, M., Wu, C. C., ... and Van Nguyen, H. (2020). Radiologist-level covid-19 detection using ct scans with detail-oriented capsule networks. *arXiv preprint arXiv:2004.07407*, 1-11.





**Deepika and Rajeswari**

17. Singh, K. K., Siddhartha, M. and Singh, A. (2020b). Diagnosis of coronavirus disease (COVID-19) from chest X-ray images using modified Xception Net. *Romanian Journal of Information Science and Technology*, 23(657): 91-115.
18. Rahimzadeh, M. and Attar, A. (2020). A modified deep convolutional neural network for detecting COVID-19 and pneumonia from chest X-ray images based on the concatenation of Xception and ResNet50V2. *Informatics in Medicine Unlocked*, 19: 1-9.
19. Mahmud, T., Rahman, M. A., & Fattah, S. A. (2020). CovXNet: A multi-dilation convolutional neural network for automatic COVID-19 and other pneumonia detection from chest X-ray images with transferable multi-receptive feature optimization. *Computers in biology and medicine*, 122, 103869.
20. Hall, L. O., Paul, R., Goldgof, D. B. and Goldgof, G. M. (2020). Finding covid-19 from chest x-rays using deep learning on a small dataset. arXiv preprint arXiv:2004.02060, 1-8.
21. Tabik, S., Gómez-Ríos, A., Martín-Rodríguez, J. L., Sevillano-García, I., Rey-Area, M., Charte, D., & Herrera, F. (2020). COVIDGR dataset and COVID-SDNet methodology for predicting COVID-19 based on Chest X-Ray images. *IEEE Journal of Biomedical and Health Informatics*, 24(12), 3595-3605.
22. Maghdid, H. S., Asaad, A. T., Ghafoor, K. Z., Sadiq, A. S., Mirjalili, S. and Khan, M. K. (2021). Diagnosing COVID-19 pneumonia from X-ray and CT images using deep learning and transfer learning algorithms. In: *Multimodal Image Exploitation and Learning*, International Society for Optics and Photonics, 11734: 1-8.
23. Brunese, L., Mercaldo, F., Reginelli, A. and Santone, A. (2020). Explainable deep learning for pulmonary disease and coronavirus COVID-19 detection from X-rays. *Computer Methods and Programs in Biomedicine*, 196: 1-30.
24. Wang, L., Lin, Z. Q. and Wong, A. (2020). Covid-net: A tailored deep convolutional neural network design for detection of covid-19 cases from chest x-ray images. *Scientific Reports*, 10(1): 1-12.
25. Boudrioua, M. S. (2020). COVID-19 detection from chest X-ray images using CNNs models: further evidence from deep transfer learning. *The University of Louisville Journal of Respiratory Infections*, 4(1): 1-4.
26. Afshar, P., Heidarian, S., Naderkhani, F., Oikonomou, A., Plataniotis, K. N. and Mohammadi, A. (2020). Covid-caps: a capsule network-based framework for identification of covid-19 cases from x-ray images. *Pattern Recognition Letters*, 138: 638-643.
27. Pereira, R. M., Bertolini, D., Teixeira, L. O., Silla Jr, C. N. and Costa, Y. M. (2020). COVID-19 identification in chest X-ray images on flat and hierarchical classification scenarios. *Computer Methods and Programs in Biomedicine*, 194: 1-18.
28. Wang, S., Kang, B., Ma, J., Zeng, X., Xiao, M., Guo, J., & Xu, B. (2021). A deep learning algorithm using CT images to screen for corona virus disease (COVID-19). *European Radiology*, 14: 1-9.
29. Shamsi, A., Asgharnezhad, H., Jokandan, S. S., Khosravi, A., Kebria, P. M., Nahavandi, D. & Srinivasan, D. (2021). An Uncertainty-Aware Transfer Learning-Based Framework for COVID-19 Diagnosis. *IEEE transactions on neural networks and learning systems*, 32(4), 1408-1417.
30. Sakib, S., Tazrin, T., Fouda, M. M., Fadlullah, Z. M., & Guizani, M. (2020). DL-CRC: deep learning-based chest radiograph classification for COVID-19 detection: a novel approach. *IEEE Access*, 8, 171575-171589.
31. Rajaraman, S., Siegelman, J., Alderson, P. O., Folio, L. S., Folio, L. R., & Antani, S. K. (2020). Iteratively pruned deep learning ensembles for COVID-19 detection in chest X-rays. *IEEE Access*, 8, 115041-115050.
32. Huang, L., Ruan, S., & Denoeux, T. (2021). Covid-19 classification with deep neural network and belief functions. arXiv preprint arXiv:2101.06958.
33. Hassantabar, S., Ahmadi, M., & Sharifi, A. (2020). Diagnosis and detection of infected tissue of COVID-19 patients based on lung X-ray image using convolutional neural network approaches. *Chaos, Solitons & Fractals*, 140, 110170.
34. Islam, M. Z., Islam, M. M., & Asraf, A. (2020). A combined deep CNN-LSTM network for the detection of novel coronavirus (COVID-19) using X-ray images. *Informatics in medicine unlocked*, 20, 100412.
35. Chowdhury, N. K., Rahman, M. M., & Kabir, M. A. (2020). PDCoVIDNet: a parallel-dilated convolutional neural network architecture for detecting COVID-19 from chest X-ray images. *Health information science and systems*, 8(1), 1-14.





**Deepika and Rajeswari**

**Table 1 Comparison of deep learning based COVID-19 detection techniques.**

Ref no	Techniques used	Number of images	Performance accuracy (%)
[7]	Voting - Based Approach and Cross-dataset analysis	219 COVID-19 positive, 1341 normal and 1345 viral pneumonia chest X-ray images.	96.58%
[8]	Image Preprocessing and 3D CNN	110 COVID-19 and 399 healthy cases	86.7%
[9]	VGG19	206 COVID-19 and 364 pneumonia cases	95.6%
[10]	Customized CNN and Squeezenet	397 CT scans of healthy patients and 360 CT scans of COVID-19 subjects	85.03%
[11]	2D Sparse Matrix Profile and Densenet	198 Non-COVID-19 and 275 COVID-19 cases	DenseNet 201 with anomaly detection - 78.7%, without anomaly detection - 77.9%
[12]	Weakly-Supervised Deep Learner, U-Net-Based Partition Network	80- covid, 78 pneumonia, 72 normal patients	87.3%
[13]	DCNN, Resnet50, Inceptionv3 and Inception-Resnetv2	341 COVID-19 Cases, 2800 normal cases.	96.1%
[14]	Random Under-Sampling and Coronet	284 COVID-19, 330 bacterial pneumonia, 327 viral influenza and 310 healthy cases	90%
[15]	Multi-Task Deep Learner, Inception Residual Recurrent CNN along TL	420 total samples, 247 normal samples 178 COVID-19 samples	84.67% (X-ray images) and 98.78% (CT-images)
[16]	Detail-Oriented Capsule Networks, Peekaboo Learning Process and GAN	349 CT images - COVID-19 and 397 CT images - non-COVID-19.	87.6%
[17]	Xceptionnet And CNN	Total 1419 images; 132 images- COVID cases, 619 cases - viral pneumonia and 668 -healthy cases	95.80%
[18]	Image Augmentation, Xception and Resnet50 Fused Classification	180 COVID-19, 6,054 influenza and 8,851 healthy cases	91%
[19]	Covcnet (CNN-Based Model)	1,583 healthy and 1,493 viral influenza, 2,780 bacterial pneumonia and 305 COVID-19 cases	90.2%
[21]	Image Augmentation, Resnet50 and VGG16 With CNN Classification	135 COVID-19, 320 viral and bacterial pneumonia cases	91%
[22]	COVID-Sdnet	1,583- Normal(healthy), 4,273- Pneumonia and 76- COVID-19	82%
[23]	Powerful CNN	COVID-19 – 85 (X-ray); 203 (CT) Normal – 85 (X-ray); 153(CT)	94% (X-ray) 94.1% (CT)
[24]	DCNN	13,975 CXR images across 13,870 patient cases	93.6%
[25]	Deep Learner System And	309 actual COVID-19 chest x-ray images, 2,000	99.4%





**Deepika and Rajeswari**

	Pre-Trained CNNs	instances of pneumonia chest x-ray images, and 1,000 healthy chest x-ray images	
[26]	Covid-Caps	112,120- X-ray images and 14 - thorax abnormalities.	95.7%
[27]	Image Resampling, Merging and Pre-Trained CNN Classification	90 COVID-19, 1,000 healthy, 10 MERS, 11 SARS, 10 Varicella, 12 Streptococcus, 11 influenza cases	89%
[28]	ROI and TL Neural Network	1065 representative images 740- COVID-19 negative and 325 -COVID-19 positive	85.2%
[29]	Deep Uncertainty-Aware TL Technique and Pre-Trained CNN Models	Chest X-Ray images 25- COVID-19 images; 75- non-Covid images. CT Images- 349 Covid images; 397 non-Covid images.	ResNet50 and linear SVM classifier -87.9%
[30]	DL-CRC DARI Algorithm and CNN Model	X-ray images- 27,228 - Normal; 5,794- pneumonia; 209 – COVID-19	93.94%
[31]	Customized CNN And Selection of Imagenet Pretrained models	CXR image dataset- 1349- Normal; 165- COVID-19	99.01%
[32]	Evidential Covid-Net Model, CNN Model and Belief Function-Based Classification Module.	397- Non- COVID-19 349- COVID-19	81%
[33]	CNN	315 COVID-19 and 367 healthy cases	93%
[34]	Regularization and CNN-LSTM Classification	1,525 COVID-19, 1,525 infleunza and 1,525 healthy cases	99.4%
[35]	PD-CovidNet and CNN Layer	219 COVID-19, 1341 Normal, 1345 pneumonia	96.58%





## Kinetic and Isothermic Modeling over PANI@HNT for Scavenging Diclofenac (DCL) Drug from its Aqueous Solution.

Perna Higgins<sup>1\*</sup>, Shaziya H Siddiqui<sup>2</sup>, Amit Chattree<sup>3</sup> and Runit Isaac<sup>1</sup>

<sup>1</sup>Research Scholar, Department of Chemistry, Sam Higginbottom University of Agriculture Technology and Sciences, Prayagraj, U.P. India.

<sup>2</sup>Assistant Professor, Department of Chemistry, Sam Higginbottom University of Agriculture Technology and Sciences, Prayagraj, U.P. India.

<sup>3</sup>Associate Professor, Department of Chemistry, Sam Higginbottom University of Agriculture Technology and Sciences, Prayagraj, U.P. India.

Received: 29 Oct 2021

Revised: 20 Dec 2021

Accepted: 06 Jan 2022

### \*Address for Correspondence

#### Perna Higgins

Research Scholar,

Department of Chemistry,

Sam Higginbottom University of Agriculture Technology and Sciences,

Prayagraj, U.P. India.

Email: prehig@yahoo.in



This is an Open Access Journal / article distributed under the terms of the **Creative Commons Attribution License** (CC BY-NC-ND 3.0) which permits unrestricted use, distribution, and reproduction in any medium, provided the original work is properly cited. All rights reserved.

### ABSTRACT

Pharmaceutical drug contamination in water nowadays is adversely influencing the ecological components. A remedial approach is therefore a necessity. The interaction of drug diclofenac (DCL) and polyaniline@halloysite (PANI@HNT) showed equilibrium time 90 min favoured at pH 5.0 achieving maximum adsorptive capacity ( $q_e$ ) 475.79 mg g<sup>-1</sup>. The adsorption process followed the pseudo-second order kinetic model with intra-particle diffusion model as the governing step and Langmuir isotherm was the best suited model having monolayer capacity ( $q_m$ ) 500 mg g<sup>-1</sup> and Freundlich model inferred about the feasibility of the adsorption process.

**Keywords:** polyaniline ; halloysite; diclofenac; adsorption capacity ; Langmuir.

### INTRODUCTION

Amongst several analgesics the diclofenac drug is cosmopolitanly a remedy used for several painful and swelling disorders [1] Diclofenac is commonly used and recommended in massive quantities and therefore wastewater as well as natural water bodies around the world has been detected with it. [2] [3] Intake of drinking water with diclofenac has also showed devastating results in liver and kidney cytotoxicity, damage in the gastrointestinal tract, dysfunctioning in platelets, and human convulsion [4] [5] Since, diclofenac has a high water solubility and polarity, fairly low pH, so it is not easy to eradicate them completely from water by making the use of the conventional water







**Perna Higgins et al.,**

purifying methods [6] [7]. Various water purifying approaches have been taken into consideration for the eradication of pharmaceutical drugs from waste water including the physico-chemical techniques such as anodic oxidation [8] ozonation, U-V irradiation [9] catalytic wet air oxidation [10] electro-oxidation [11] adsorption [12] and other biological methods which are biosorption [13] and phytoremediation [14]. However, these techniques have resulted in contributing more in the production of residual toxic materials [15] and are highly expensive as a result adsorption technique is applied as it involves easy operation, lower energy requirement, also it is environment friendly, reusable, cost effective.

However, a number of adsorbents like, modified silicates, zeolites [16] [17] resins [18] as well as metal organic frameworks (MOFs) [19] [20] have also been employed for pharmaceutical drug removal. Halloysite nanotubes (HNT) has a tubular structure in which the atoms are arranged in a close orientation to give large specific surface area with a strong electrical conductivity and stabilized chemical properties [21] Rigidity in the organic skeleton and a property of reversible doping and de-doping by polyaniline (PANI) makes the adsorption process and regeneration feasible [22] Thus, in this experimentation an approach was initiated in order to make an adsorbent by combining HNT and PANI on account of its super properties. Therefore, this study utilizes PANI@HNT for adsorbing DCL from its aqueous solution as it renders a massive surface area, numerous reactive sites [23]. The operating parameters like effect of solution pH, concentration change and reaction time was studied. The process of adsorption was evaluated kinetically and isothermally to understand the adsorption behavior for DCL adsorption thereby proving the efficacy of PANI@HNT.

## MATERIAL AND METHODS

### Materials

Diclofenac ( $C_{14}H_{10}Cl_2NNO_2$ ), aniline ( $C_6H_5NH_2$ ), sodium hydroxide (NaOH), hydrochloric acid (HCL), ammonium per oxy disulfate  $(NH_4)_2S_2O_8$  and halloysite nanotubes (HNT) was purchased from Sigma-Aldrich. De-ionized water was utilized for the experimentation.

### Equipments for Characterizing HNT@PANI

The before and after drug concentration was examined at  $\lambda_{max}$  210 nm by the Ultraviolet-visible spectrophotometer (Perkin Elmer, USA model).

### Synthesis of PANI@HNT

PANI was prepared by adding 50 mL ammonium per oxy disulfate to 1 mL aniline for polymerization, then it was added to 2.73 g HNT with continuous stirring for 14 h. A dark green precipitate PANI@HNT was obtained as a resultant which was then filtered, washed with excess de-ionized water then dried for over 15 h and was then further employed as an adsorbent for carrying laboratory work.

### Batch experimentation

The experimentation was facilitated in batch mode to understand the uptake process by applying kinetic and isotherm models involving pH variation, concentration change and equilibrium time. A fixed quantity of HNT@PANI (0.02 g) in 20 mL of 500 mg L<sup>-1</sup> DCL solution was added. The pH was altered using 0.1 M HCL and NaOH. The DCL concentration was analyzed by Ultraviolet-Visible Spectrophotometer at 210 nm and the surface utmost capacity and the percentage removal for DCL was ciphered by the formula :-

$$q_e = \frac{(C_o - C_e)V}{W}$$

[1]





Prerna Higgins et al.,

$$\% \text{ removal} = \frac{(C_o - C_e)}{C_o} \cdot 100 \quad [2]$$

Where,  $q_e$  is the maximum achieved capacity of HNT@PANI at equilibrium ( $\text{mg g}^{-1}$ ),  $V$  is the total volume of DCL solution (L),  $W$  is the weight of HNT@PANI (g),  $C_o$  is the before DCL concentration ( $\text{mg L}^{-1}$ ),  $C_e$  is the after DCL concentration at equilibrium ( $\text{mg L}^{-1}$ ).

## RESULT AND DISCUSSION

### pH variation study

The pH variation study was performed in the gamut 1-10 which depicted utmost adsorptive capacity at pH 5.0. A sharp enhanced adsorption of DCL was seen upto pH 5.0 which at pH 6.0 took a sudden drop and then showed gradual decrease uptill pH 10.0 as clearly seen in Fig. 1(a). The point of zero charge ( $\text{pH}_{\text{pzc}}$ ) was also analysed by recording the prior and later values shown in Fig. 1(b). The charge on PANI@HNT surface became zero at 5.0. This can be attributed to the pka 4.2 of DCL with anionic form existence in solution [24] which may be the reason for adsorption of DCL.

### Assessing Reaction time and kinetics

The adsorption experiment for reaction time was carried out by adding 0.02g of HNT@PANI to 20 mL of DCL solution ranging from 15 to 300 mins. The results for scavenging of the DCL is shown in Fig.2(a). The DCL adsorption over HNT@PANI was rapid and equilibrium at 90 min was obtained which indicated nearly complete removal and became constant when all the free sites on the HNT@PANI was occupied [25]. Fitting the kinetic data to pseudo-first order [26] pseudo-second order [27] and intra-particle diffusion model [28] revealed the rate of DCL adsorption onto the PANI@HNT.

*Kinetics for Pseudo-first order model*

$$\log(q_e - q_t) = \log q_e - \frac{k_1 t}{2.303} \quad [3]$$

*Kinetics for Pseudo-second order model*

$$\frac{t}{q_t} = \frac{1}{k_2} q_e^2 + \frac{t}{q_e} \quad [4]$$

Where, the reaction uptake time is  $t$  in (min),  $q_e$  and  $q_t$  is the PANI@HNT uptake capability at equilibrium time ( $\text{mg g}^{-1}$ ),  $k_1$  ( $\text{min}^{-1}$ ) and  $k_2$  ( $\text{g mg}^{-1} \text{min}^{-1}$ ) is the value for pseudo-first and second order rate constant. The data of  $q_e$  experimental and  $q_e$  calculated for both applied models in Fig. 2(b,c) justified that the  $q_e$  calculated for pseudo-second order kinetic model is very near to the  $q_e$  experimental than the  $q_e$  of pseudo first order kinetic model. Moreover, the  $R^2$  values that were obtained from the equation of the linear pseudo-second order is near to unity and is higher than the  $R^2$  values acquired from the equation of the pseudo-first order. Therefore, the deductions made it clear that the scavenging of DCL onto PANI@HNT were following the kinetic model of pseudo-second order.

*Intra-particle diffusion model*

$$q_t = k_{\text{id}} t^{1/2} + C \quad [5]$$

where,  $k_{\text{id}}$  ( $\text{mg g}^{-1} \text{min}^{1/2}$ ) is the intra-particle diffusion rate constant and  $C$  being the constant related to the thickness of boundary layer.

The intra-particle diffusion is clearly the rate-governing step in Fig.2(c) as evidenced by the high intercept value with high  $k_{\text{id}}$  and the regression coefficient  $R^2$  as in Table 1.





**Prerna Higgins et al.,**

### Effect of prior DS concentration and isotherm modelling

The adsorbent quantity employed was fixed and was treated with different DCL concentrations solution ranging between 100 to 500 mg L<sup>-1</sup> as shown in Fig.3a. The presence of free sites over the adsorbent surface gave high adsorption capacity of HNT@PANI [29] and allowed for feasible molecule diffusion into the pores of the HNT@PANI increased uptake for adsorption [24]

Langmuir and Freundlich [30] models were investigated to fit the adsorption equilibrium results. The applied models linear equations are as follows.

*Langmuir isotherm model*

$$\frac{C_e}{q_e} = \frac{1}{b} \cdot q_m + \frac{C_e}{q_m} \quad [6]$$

where,  $C_e$  is the DCL equilibrium concentration (mg L<sup>-1</sup>),  $q_e$  and  $q_m$  (mg g<sup>-1</sup>), is the PANI@HNT highest uptake and monolayer capacity, Langmuir constant is denoted by  $b$  (L mg<sup>-1</sup>) relating to free energy of adsorption.

*Freundlich isotherm model*

$$\log q_e = \log K_f + \frac{1}{n} \log C_e \quad [7]$$

where,  $K_f$  and  $(1/n)$  is Freundlich constant being related to capacity of adsorption its intensity, respectively. The value for constant  $n$  came to be 3.43 as in Table 2 which deduced for a feasible adsorption The  $R^2$  value obtained from linear plot of Langmuir was higher than the  $R^2$  attained from the linear plot of the Freundlich model in Fig.3 (b,c) The Langmuir model was found to be the perfect suited model for DCL scavenging by PANI@HNT suggesting the formation of monolayer adsorption.

## CONCLUSION

Varied parameters like effect of pH, reaction time and concentration change was studied. The adsorption process with higher adsorption capacity 475.79 mg g<sup>-1</sup> was favoured at 5.0 and equilibrium time was recorded at 90 min. The resultant data was analyzed using pseudo first order kinetic model, pseudo second order kinetic model, intra-particle diffusion model in which the best suited was the pseudo second model involving intra-particle as the governing step. The adsorption isotherm study was carried out using Langmuir and Freundlich model in which Langmuir model was the best suited model exhibiting 500 mg g<sup>-1</sup> monolayer adsorption capacity ( $q_m$ ) Therefore, the applied adsorbent exhibited promising results to be employed for future sustainability.

## ACKNOWLEDGEMENT

My sincere thanks to the Department of Chemistry, Sam Higginbottom University of Agriculture Technology and Sciences, India for providing me assistance to carry out the experimentation.

## REFERENCES

1. Memmert, U. Peither, A. Burri, R. Weber, K. Schmidt, T. Sumpter, J.P. Hartmann, A. 2013 Diclofenac: New data on chronic toxicity and bioconcentration in fish. *Environm Toxicol and Chem.* 32 : 442–452.
2. Boyda, G.R. Reemtsmaa, H. Grimmb, D.A. Mitra, S. 2003. Pharmaceuticals and personal care products (PPCPs) in surface and treated waters of Louisiana, USA and Ontario, Canada. *Sci of the Total Environ.* 311 : 135–149.





## Prerna Higgins et al.,

3. Verlicchi, P. Aukidy, M.A. Zambello, E. 2012. Occurrence of pharmaceutical compounds in urban wastewater: removal, mass load and environmental risk after a secondary treatment—a review. *Sci of Total Environ*, 429 : 123– 155.
4. Fei, X.W. Liu, L.Y. Xu, J.G. Zhang, Z.H. Mei, Y.A. 2006. The non-steroidal anti-inflammatory drug, diclofenac, inhibits  $\text{Na}^+$  current in rat myoblasts. *Biochem and Biophys Res Commun*. 346 : 1275–1283.
5. Tiwari, D. Lalhriatpuia, C. Lee, S.M. 2015. Hybrid materials in the removal of diclofenac sodium from aqueous solutions: Batch and column studies. *J. of Indust and Engg Chem*. 30:167-173.
6. Zhang, Y.L. Liu, Y.J. Dai, C.M. Zhou, X.F. Liu. S.G. 2014. Adsorption of clofibrac acid from aqueous solution by graphene oxide and the effect of environmental factors. *Wat Air Soil Pollut*. 225:2064.
7. Chen, Y. Vymazal, J. Březinová, T. Koželuh, M. Kule, L. Huang, J. Chen Z., 2016. Occurrence, removal and environmental risk assessment of pharmaceuticals and personal care products in rural wastewater treatment wetlands. *Sci of the Tot Environ*. 566–567 : 1660–1669.
8. Brillas, E.S. Garcia, S. Skoumal, M. Arias, C. 2010. Electrochemical incineration of diclofenac in neutral aqueous medium by anodic oxidation using Pt and boron-doped diamond anodes. *Chemosph*. 79 : 605–612.
9. Lateefa, A. Al-Khateeb. Hakami, W. Mohamad, A.S. 2016. Removal of non-steroidal anti-inflammatory drugs from water using high surface area nanographene: Kinetic and thermodynamic studies. *J of Molecul Liquids*. doi: 10.1016/j.molliq.2017.06.068
10. Quesada, P Isariebel. J.L. Carine. Jauregui, H. Ulises, J. Wilhelm. Anne, M. Delmas, H. 2012. Degradation of paracetamol by catalytic wet air oxidation and sequential adsorption – Catalytic wet air oxidation on activated carbons. *J Hazard Mater*. 221-222: 131-138.
11. Kumar, A., Omar, R. A., & Verma, N. (2020). Efficient electro-oxidation of diclofenac persistent organic pollutant in wastewater using carbon film-supported Cu-rGO electrode. *Chemosph*, 248, 126030.
12. Ahmad, R. Haseeb, S. 2017. Adsorption of Pb (II) on Menthapiperita carbon (MTC) in single and quaternary systems. *Arab J of Chem*. 10: 412-421.
13. Liu, M. Jia, Z. Jia, D. Zhou, C. 2014. Recent advance in research on halloysite nanotubes-polymer nanocomposite. *Prog. Polym. Sci*. 39, 1498–1525.
14. Jeevanantham, S. Saravanan, A. Hemavathy, R.V. Kumar, P.S. Yaashikaa, P.R. Yuvaraj, D. 2019. Removal of toxic pollutants from water environment by phytoremediation: A survey on application and future prospects. *Environm Technol and Innov*. 13: 264–276.
15. Esplugas, S. Bila, D.M. Gustavo, L. Krause, T. 2007. Ozonation and advanced oxidation technologies to remove endocrine disrupting chemicals (EDCs) and pharmaceuticals and personal care products (PPCPs) in water effluents. *J. of Hazard Mater*. 149 : 631–642.
16. Krajisnik, D. Dakovic, A. Milojevic, M. Malenovic, E. Kragovic, M. Bogdanovic, D.B. Dondur, V. Milic, J. 2011. Properties of diclofenac sodium sorption onto natural zeolite modified with cetylpyridinium chloride. *Coll Surf: B*. 83 : 165–172.
17. Suriyanon, N. Punyapalukul, P. Ngamcharussrivichai, C. 2012. Mechanistic study of diclofenac and carbamazepine adsorption on functionalized silica-based porous materials. *ChemEngg J*. 214 : 208–218.
18. Jiang, M. Yang, W. Zhang, Z. Yang, Z. Wang, Y. 2015. Adsorption of three pharmaceuticals on two magnetic ion-exchange resins. *J. of EnvironmSci*. 31: 226 – 234.
19. Hasan, Z. Jeon, J. Jhung, S.H. 2012. Adsorptive removal of naproxen and clofibrac acid from water using metal-organic frameworks. *J. of Hazard Mater*. 209: 151-157.
20. Hasan, Z. Khan, N.A. Jhung, S.H. 2016. Adsorptive removal of diclofenac sodium from water with Zr-based metal–organic frameworks. *ChemEngg J*. 284 : 1406- 1413
21. Xiang, H. Chen, Z. 2015. Removal of diclofenac from aqueous solution with multi-walled carbon nanotubes modified by nitric acid. *Chin J of Chem Engg*. 22 :7.
22. Wang, N. Chen, J. Wang, J. Feng, J. Yan, W. 2019. Removal of Methylene blue by Polyaniline/TiO<sub>2</sub> hydrate: Adsorption kinetic, isotherm and mechanism studies. *Powder Technol*. 347 : 93-102.
23. Youssef, A.M. El-Naggar, M.E. Malhat, F.M. El-Sharkawi, H.M. 2019. Efficient removal of pesticides and heavy metals from wastewater and the antimicrobial activity of f-MWCNTs/PVA nanocomposite film, *J. Clean. Prod*. 206 :315-325.





**Perna Higgins et al.,**

24. Zheng, X. Wang, J. Xue, X. Liu, W. Kong, Y. Cheng, R. Yuan, D. 2018. Facile synthesis of Fe<sub>3</sub>O<sub>4</sub>@MOF-100 (Fe) magnetic microspheres for the adsorption of diclofenac sodium in aqueous solution. *Environ Sci Poll Res.* 25: 31705-31717.

25. Zhou, S. Zhou, Z. Vakili, M. Qi, Y. Jia, Y. Zhu, D. Wang, W. 2020. Adsorptive removal of diclofenac sodium from aqueous solution by magnetic COF: Role of hydroxyl group on COF. *Coll and Surf A: Physicochem and Engg Aspects.* doi: <https://doi.org/10.1016/j.colsurfa.2020.125238>.

26. Lagergren, S.K. 1898. About the theory of so-called adsorption of soluble substances. *Sven Vetenskapskad.*

27. Ys, H. Mckay, G. 1999. Pseudo-second order model for sorption processes. *Process Biochem.* 34(5):451-465.

28. [28] Weber, W.J. Morris, J.C. 1963. Kinetics of adsorption on carbon from solution. *J Sanitary Eng Division.* 89(2):31-60.

29. ALothman, Z.A. Naushad, M. Ali, R. 2013. Kinetic, equilibrium isotherm and thermodynamic studies of Cr(VI) adsorption onto low-cost adsorbent developed from peanut shell activated with phosphoric acid. *Environ. Sci. Pollut. Res.* 20: 3351–3365.

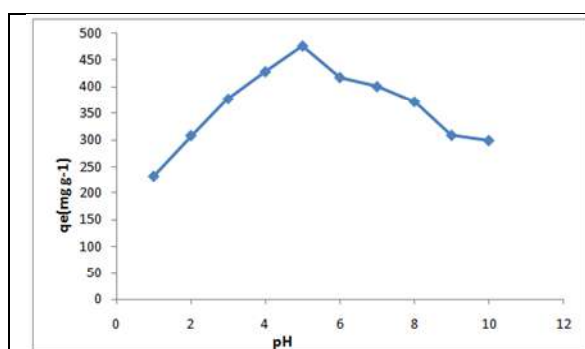
30. Freundlich, H.M.F. 1906. Over the adsorption in solution. *J PhysChem.* 57(385471):1100-1107.

**Table 1: Kinetic parameters for different models**

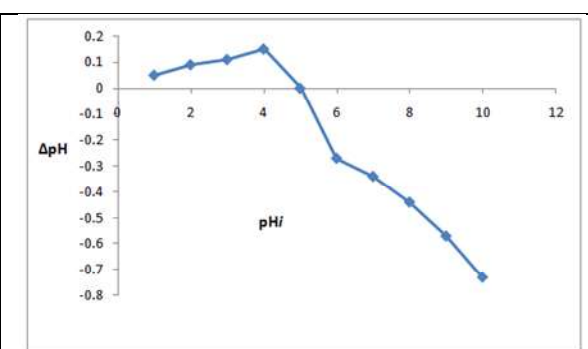
Pseudo 1 <sup>st</sup> Order		Pseudo 2 <sup>nd</sup> Order		Intra-particle diffusion	
Q <sub>e</sub> (exp) (mg/g)	475.79	Q <sub>e</sub> (exp) (mg/g)	475.79	K <sub>id</sub>	1.44
Q <sub>e</sub> (cal)	14.85	Q <sub>e</sub> (cal)	480.80	C	676.20
K <sub>1</sub> (min <sup>-1</sup> )	0.004	K <sub>2</sub> (g/mg/min)	0.000024	R <sup>2</sup>	0.9550
R <sup>2</sup>	0.9230	R <sup>2</sup>	0.9940		

**Table 2: Isotherm parameters for different models**

<b>Langmuir isotherm</b>	
Q <sub>m</sub> (mg g <sup>-1</sup> )	500
B	0.04
R <sup>2</sup>	0.9980
<b>Freundlich isotherm</b>	
K <sub>r</sub> (mg g <sup>-1</sup> )	50.93
n	3.43
R <sup>2</sup>	0.9540



**Fig 1(a). Effect of pH**

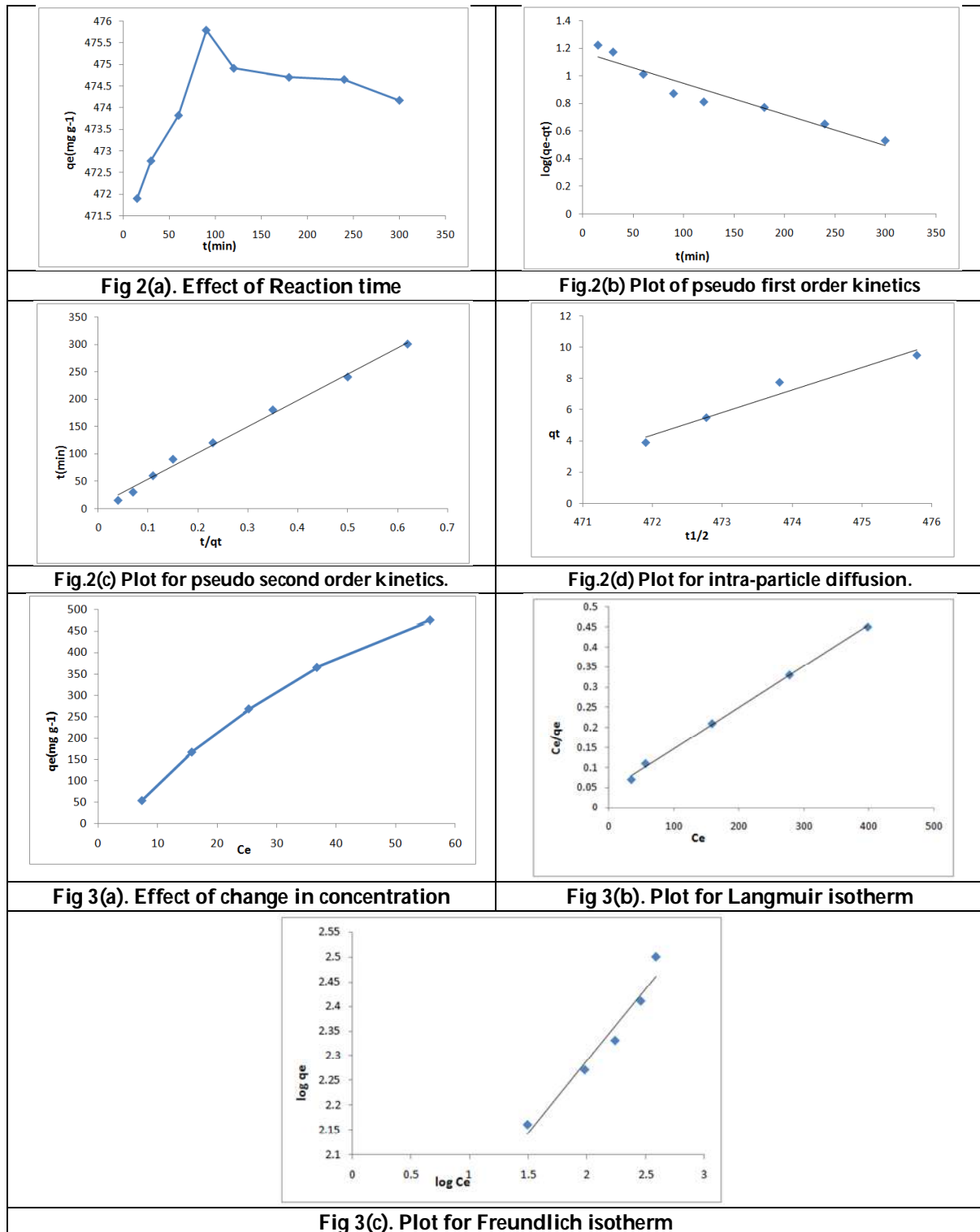


**Fig 1(b). Point of zero charge (pH<sub>pzc</sub>)**





Prerna Higgins et al.,





## **In-vitro Screening of Aqueous Extracts of Selected Plants for Antibacterial Activity against Wound Infection Isolates**

Uma Dutta<sup>1\*</sup> and Kanyaga Parameshwari M<sup>2</sup>

<sup>1</sup>Head and Associate Professor, Department of Zoology, Cotton University, Guwahati, Assam, India.

<sup>2</sup>Research Scholar, Department of Zoology, Cotton University, Guwahati, Assam, India.

Received: 11 Nov 2021

Revised: 14 Dec 2021

Accepted: 11 Jan 2022

### **\*Address for Correspondence**

#### **Uma Dutta**

Head and Associate Professor,  
Department of Zoology,  
Cotton University, Guwahati,  
Assam, India.

Email: umadutta@yahoo.com



This is an Open Access Journal / article distributed under the terms of the **Creative Commons Attribution License** (CC BY-NC-ND 3.0) which permits unrestricted use, distribution, and reproduction in any medium, provided the original work is properly cited. All rights reserved.

### **ABSTRACT**

Herbs have been used for ages for curing common ailments like cold, skin infections, wounds, etc. In India, many plant species are used in indigenous system of medicine. Wound infections are one of the commonest infections, which occur as a complication of wounds caused by surgery, injury or a disease which interrupts the skin or mucosa. The present study highlights the screening of aqueous extracts of leaves of *Acalypha indica*, *Cassia occidentalis*, *Leucas aspera*, *Ocimum sanctum*, *Solanum nigrum*, *Carica papaya*, *Nyctanthes arbor-tristis* and *Paederia foetida* and a combined herbal extract (CHE) of four of the chosen plants, for activity against bacteria isolated from infected wounds. Bacteria isolated from infected wound samples were identified as *Staphylococcus aureus*, *Escherichia coli*, *Klebsiella sp.*, *Proteus sp.* and *Pseudomonas sp.* In relation to the number of bacterial isolates, the antibacterial activity of the CHE of *A.indica*, *O.sanctum*, *C.papaya* and *L.aspera* was the highest. Among the individual plant extracts, antibacterial activity was maximum in *A.indica* and minimum in *S.nigrum*, while *P. foetida* did not show any activity at all. Thus, the efficacy of antibacterial activity was graded in the following order: CHE > *A.indica* > *O.sanctum* > *C.papaya* > *L.aspera* > *C.occidentalis* > *N.arbor-tristis* > *S.nigrum*. Among the bacterial isolates, maximum activity exhibited was against *S.aureus* followed by inhibition of *Klebsiella sp.* and *E.coli*. *Pseudomonas sp.* was inhibited moderately and *Proteus sp.*, the least. It can be concluded that the CHE and most of the selected plants have potential antibacterial effect. Further pharmacodynamic investigations are essential to identify the active phytochemicals of the extracts.

**Keywords:** Antibacterial activity; Aqueous extract; Plants; Wound infections





## INTRODUCTION

Plants are known for their usage in traditional medicine since ages. Traditional medicine broadly refers to the many indigenous systems of medicine that have been in practice among local populaces around the world. Some examples of such time-honoured systems include Indian Ayurveda, Arabic Unani, and Chinese traditional medicine [1]. These systems use numerous extracts derived from natural sources including different parts of plants, animal derived materials, minerals etc [2-3]. The renowned Indian system of Ayurveda is believed to make use of more than 1000 plant genera comprising of about 2500 species [4]. Plant derived drugs are becoming more popular in the recent ages as they seem to be non-toxic and have fewer side-effects as exemplified by their long history of use [5]. According to a recent report by World Health Organization there has been a significant increase from 2005 to 2018, in the number of countries which incorporate traditional herbal medicines in their national essential medicines list and India is one of them [6].

The popularity of phytomedicine is also supported by scientific evidence. A number of studies have reported the preventive and therapeutic properties of plants, and their use in the management of many infective diseases [7-9]. The antimicrobial properties of plants can be attributed to their production of bioactive components as secondary metabolites, such as polyphenols, tocopherols, carotenoids, ascorbic acid [10-11]. Bacterial infections of wounds are one of the commonest infections. Wound can be defined as a disruption in the interruption of a living tissue's cellular, anatomical, and functional continuity as a result of injuries to the skin that disrupt the soft tissue. The incidence of wound infections is more frequent in developing and under developed nations due to insufficient sanitation practices [12]. When the skin is impaired, bacteria can infiltrate into underlying tissues cause infection and impair wound healing [13]. Bacteria generally encountered in wound infections are *Staphylococci* sp., *Pseudomonas* sp., *Enterobacteriaceae* sp. [14]. Anaerobes like *Clostridium* sp., *Fusobacterium* sp., can cause deep wound infections [15]. Combating and preventing bacterial infections is an important factor in the process of wound healing.

In most developing countries, remote village dwellers, tribes and native people prefer the use of medicinal plants due to its efficiency and easy availability in their vicinity. A few reports show that plant parts or whole plants in traditional medicine are either crushed and applied directly or made into a paste for topical application on wound injuries like cuts, burns and abscesses [16]. But there is very less or no proper scientific validation and also paucity of literature on this aspect. Thus, the present study was aimed at screening the aqueous extracts of the selected plants to evaluate their antibacterial activity against bacteria isolated from wound infections. In the current investigation, plants used commonly in and around Gowrivakam (Tamilnadu) and Guwahati city (Assam) were chosen. Most of the selected plants have proven medicinal uses. Leaves of *Acalypha indica* are used traditionally in treating syphilitic ulcers, extract of *Ocimum sanctum* leaves is used as an expectorant [17]. *Carica papaya* leaves are reported to have anti-inflammatory activities [18]. *Leucas aspera* has been shown to have anti-oxidant activity [19]. *Nyctanthes arbor-tristis*, *Cassia Occidentalis*, and *Paederia foetida* have been reported in separate investigations to -have anti allergic [20], antimicrobial [21-22] and antihelminthic [23] properties respectively.

## MATERIALS AND METHODS

### Collection, identification and extract preparation of plants:

#### Site of plant Collection, identification and preparation of extract

Plants were collected in and around Gowrivakkam, Chennai, Tamilnadu and Cotton University campus and botanical garden of Cotton University, Guwahati, Kamrup district, Assam. *Acalypha indica*, *Ocimum sanctum*, *Leucas aspera*, *Cassia occidentalis* and *Solanum nigrum* were collected from Tamilnadu. *Carica papaya*, *Nyctanthes arbor-* and *Paederia foetida* were collected from Assam. They were preliminarily identified by referring, An Excursion flora of central Tamilnadu, India [24] and Flora of Assam [25]. The identity of the plants were further confirmed in the Department of Microbiology, Prince Shri Venkateshwara College of Arts and Science, Chennai, Tamilnadu and





**Uma Dutta and Kanyaga Parameshwari**

Department of Botany, Cotton University, Guwahati, Assam. The plants collected in the study are listed (Table-1) with their botanical name, family, common and local name.

**Preparation of aqueous extract of plants**

The leaves of plant were thoroughly washed with distilled water and rinsed with 70% ethanol. Then they were allowed to shade dry and ground to fine powder. 50 g of the powder of each plant was dissolved in 1 litre sterile distilled water, left undisturbed in a covered condition for 72 hrs and then filtered through Whatman No.1 filter paper. The filtrate was centrifuged at 9500 g and concentrated in a vacuum desiccator (Speedvac) and stored at 4°C till further use. Four plants which are more commonly used among the collected plants were chosen for preparation of a combined herbal extract (CHE). The plants were *A.indica*, *O.sanctum*, *C.papaya* and *L.aspera*. Equal proportions of finely grounded powder of the four plants were used. The CHE was prepared in the same method as the individual plant extracts and stored at 4°C for further use.

**Collection of wound samples and isolation and identification of Bacteria:**

All the ingredients for culture media were purchased from HI-Media, prepared and used according to the manufacturer's instructions. All the reagents for preliminary tests, oxidase discs, and biochemical tests, were procured from HI-Media, prepared and used according to the manufacturer's instructions.

**Collection of wound Samples**

Fifty-three swab samples were collected from different cases of superficial wound infections from Royapettah General Hospital, Chennai. An informed consent was obtained from the patients before obtaining the samples. The identity of the patients was kept confidential. Sterile cotton swabs were used to sample the wounds and then suspended in Stuart's liquid transport medium to be brought back to the lab in an ice box for further processing.

**Isolation and identification of bacteria**

The swabs were inoculated on sterile Nutrient Agar (NA) and MacConkey Agar plates and incubated at 37°C for 24 to 48 hrs and observed for growth of bacterial colonies. Well characterized single colonies (numbered W 1 to W5) were picked up from NA plates. The isolates were identified, based on their growth characteristics on solid media, preliminary examination, biochemical profile and secondary tests [26]. All the tests were performed following standard protocol [27].

**Test for antibacterial activity****Preparation of different concentrations of the plant extract**

The aqueous extract concentrate of each plant and the CHE was further diluted with sterile distilled water so as to obtain concentration of 10 mg/ml, 1 mg/ml, 0.5 mg/ml, 0.25 mg/ml. These were tested for their anti-bacterial potential.

**Preparation of inoculums**

The test isolates were inoculated into Nutrient broth (NB) incubated at 35 ± 2°C for 4 h. The turbidity of the resulting suspensions was diluted with NB to obtain a turbidity of 0.5 McFarland (equal to 1.5 × 10<sup>8</sup> colony-forming units (CFU)/ml). Turbidity of the bacterial suspensions was measured at 600 nm.

**Antibacterial assay**

The antibacterial activity of the various concentrations of each plant extract and CHE was determined by measuring the area of growth inhibition of bacterial isolates. Test for antibacterial activity was performed by the Agar Well diffusion method [29]. 100 µl of the prepared concentrations of each plant extract were placed in the wells. After incubation at 37°C for 24 hrs the plates were observed and the diameter of the zone of inhibition was measured in millimetre (mm). Chloramphenicol (30 µg/mL) was used as a reference standard and as a positive control. However, it was not used for comparison with the zone of inhibition of plant extracts in a dose-dependent manner. The



**Uma Dutta and Kanyaga Parameshwari**

experiment was done in three replicates for each bacterium at each concentration of the plant extract along with the standard antibiotic.

**Data analysis**

Data was calculated as the mean of zones inhibition (n=3) and was tabulated as Mean±Standard deviation. Significance level was tested at P<0.05 and P< 0.01

**RESULTS****Isolation and identification of bacteria from wound samples**

Based on the results of preliminary examination and growth characteristics on solid media (Table 2), biochemical profile (Table 3) and secondary tests (Table 4) the isolates W1, W2, W3, W4 and W5 were identified as *S. aureus*, *E. coli*, *Klebsiella* sp., *Proteus* sp. and *Pseudomonas* sp. respectively, as shown in table 5.

**Antibacterial activity of plant extracts**

The zones of inhibition (in mm) of bacterial growth, produced by each plant extract and CHE at various concentrations, against all the bacterial isolates are shown in table 6. The CHE exhibited markedly higher antibacterial activity than the individual plant extracts at all concentrations, against all the bacterial isolates. The antibacterial activity of the CHE and the individual plant extracts decreased gradually with a decrease in their respective concentrations. The details of the zone of inhibition exhibited by CHE and the individual plant extracts at a concentration of 10g/ml is shown in Fig- 1. The highest zone of inhibition of CHE at a concentration of 10mg/ml was 32.3mm against *S.aureus* whereas the smallest zone was 15.1mm against *Proteus* sp. CHE showed inhibitory activity even at the lowest concentration of 0.25mg/ml, against all bacteria except *Proteus* sp.

Among the individual plant extracts, *A.indica* exhibited relatively higher zones of inhibition against most bacterial isolates up to the concentration of 0.5 mg/ml. *O.sanctum*, *C.papaya*, *L.aspera*, *C. occidentalis* and *N. arbor-tristis*, exhibited moderate antibacterial activity against all the bacterial isolates, while *S.nigrum* exhibited comparatively much smaller zones. *P. foetida* showed negligible or no activity against any isolate. At a concentration of 10mg/ml, the maximum zones of inhibition of *A.indica* were 20.2mm against *S.aureus*, 12 mm against *Pseudomonas* sp. and 10mm against *Proteus* sp. While *O.sanctum* exhibited the highest inhibitory zone against *Klebsiella* sp. with 18 mm and *L.aspera* inhibited *E.coli* the highest, with a zone of inhibition of 14.3 mm. The standard antibiotic Chloramphenicol at a concentration of 0.030mg/ml produced the maximum zone of inhibition of 25.1 mm against *S.aureus* and a lowest of 21.2mm against *Proteus* sp. Chloramphenicol was used only as a positive standard and not as a dose-dependent, comparative standard for the plant extracts.

Among the bacterial isolates, *S.aureus* was very sensitive, to all the concentrations of CHE and up to 0.5mg/ml concentration of most individual plant extracts. *Klebsiella* sp. was the second most susceptible bacteria, followed by *E.coli* and *Pseudomonas* sp. Compared to all the other bacterial isolates *Proteus* sp. was very less sensitive. It was inhibited only till 0.5 mg/ml concentration of CHE and 1mg/ml concentration of the individual plant extracts. Thus, considering the number of bacterial isolates inhibited and the lowest concentration of the extract at which inhibitory activity was observed, the overall antibacterial efficacy of CHE and the individual extracts can be more or less graded in the following order:

CHE> *A.indica*>*O.sanctum*>*C.papaya*>*L.aspera*>*C.occidentalis*>*N.arbor-tristis*>*S.nigrum*.

**DISCUSSION**

The present study highlights the screening of aqueous extract of commonly used medicinal plants for their antibacterial activity against bacteria isolated from wound infection samples. Wound samples were collected and



**Uma Dutta and Kanyaga Parameshwari**

processed for bacterial isolation. The identified isolates were *S.aureus*, *E.coli*, *Klebsiella* sp. *Proteus* sp. and *Pseudomonas* sp. Various studies have reported *S.aureus* and *Pseudomonas* sp. to be predominant bacteria in both acute and chronic wound infections [30-31]. In this study the antibacterial efficacy of the CHE was higher than those of individual plant extracts, at all concentrations. The comparatively higher efficacy of the CHE may be due to combined action of the various antibacterial components of the individual plants which can target the bacteria via different modes of action. These include disruption of cell wall, inhibition of DNA replication, inhibition of protein synthesis [32]. Studies involving polyherbal formulations show similar findings. A combination of extracts of *Azadirachta indica*, *Mimosa pudica*, *Chromolaena odorata*, *Samadera indica* in an ointment form has been reported to show better activity than standard Betadine ointment against *S.aureus* and *Bacillus* sp. [33]. In another investigation, a specific polyherbal cream extract was shown to inhibit multi drug resistant *E.coli* strains [34].

Among individual plant extracts, *A.indica* showed substantial antibacterial activity followed by *O.sanctum* and *C.papaya*, *L.aspera* and *C.occidentalis* showed considerable activity, while *N. arbor-tristis* and *S.nigrum* showed smaller zones of inhibition at their highest concentration. In several instances the findings of others have corroborated the results of the present study. Silver nanoparticles synthesized using aqueous extract of *A.indica* was found to be highly effective in inhibiting *E.coli* and *Vibrio cholerae* [35]. Aqueous extract of *O.sanctum* has been reported to have antibacterial activity against *Proteus mirabilis* [36] and *Salmonella typhi* [37]. Crude extract of *C.papaya* was found to inhibit *Bacillus.cereus* and *Pseudomonas aeruginosa* [38]. In the current study *P. foetida* showed negligible or no activity against any bacteria. However, this is not unexpected as phytoconstituents are known to vary depending on ecological factors like time of collection, climate, habitat etc. It also indicates that refinement and modification of the extraction procedure may be necessary.

The antimicrobial activity of plants are believed to be conferred by the presence of secondary metabolites such as alkaloids, flavonoids and steroids and tannins via various modes of action, for example, cell lysis and inhibition of cellular enzymes [39-40]. Phytochemical analytical studies of *A.indica* and *O.sanctum* by different researchers have established the presence of such secondary metabolites in the aqueous extracts of these plants [36 & 41]. The results of the current investigation show that the aqueous extracts of *A.indica*, *O.sanctum*, *C.papaya*, *L.aspera*, *C. occidentalis*, and *N. arbor-tristis*, have good to moderate antibacterial activity against wound infection causing bacteria. Moreover, the CHE of *A.indica*, *O.sanctum*, *C.papaya*, and *L.aspera*, has comparatively very high antibacterial efficacy than the individual extracts. Thus, the individual plant extracts, as well as the CHE are potential candidates for use as alternative medicine in the treatment of bacterial wound infections. These findings assume more significance since herbal products are cost-effective and safer than the chemical and synthetic drugs which may cause harmful side effects. Moreover, the easy availability of the selected plants and their accessibility to the common man is an added advantage. It is necessary to further evaluate the plant extracts for their respective bioactive components and consequent drug validation. The probable use of these extracts as herbal antibacterial remedies for wound infections would be a good approach in the future.

## ACKNOWLEDGEMENT

The authors are thankful to Management of Prince Shri Venkateshwara college of Arts and Science, Chennai (India) and Cotton University, Guwahati, Assam (India) for encouraging us to carry out our research. Authors are also thankful to the administration of Royapettah General hospital, Chennai (India) for providing wound samples.

## REFERENCES

1. WHO global report on traditional and complementary medicine 2019. Geneva: World Health Organization. 2019 ; 189



**Uma Dutta and Kanyaga Parameshwari**

2. Good C. Ethno-medical Systems in Africa and the LDCs: Key Issues in Medical Geography. In: Conceptual and Methodological Issues in Medical Geography. Meade MS editor. University of North Carolina at Chapel Hill. 1980, Studies in Geography 5:93-116.
3. Gesler WM. Therapeutic landscapes: medical Issues in Light of the new cultural geography. Social Science and Medicine 1992;34: 735.
4. Yadav JP, Kumar S, Siwach P. Folk medicine used in gynaecological and other related problems by rural population of Haryana. Indian J Tradit Knowle 2006; 5(3):323–326
5. Fabricant DS, Farnsworth NR. The value of plants used in traditional medicine for drug discovery. Environ Health Perspect. 2001 Mar;109 Suppl 1:69-75
6. WHO global report on traditional and complementary medicine. Geneva: World Health Organization; 2019; p.41
7. Jadhav P, Kapoor N, Thomas B, Lal H, Kshirsagar N. Antiviral potential of selected Indian medicinal (ayurvedic) plants against herpes simplex virus 1 and 2. North Am J Med Sci. 2012; 4:641-647.
8. Aqil F, Ahmad I. Antibacterial properties of traditionally used Indian medicinal plants. Methods Find exp Clin Pharmacol. 2007; 29:79–92. doi: 10.1358/mf.2007.29.2.1075347
9. Vonshak A, Barazani O, Sathiyamoorthy P, Shalev R, Vardy D, Golan-Goldhirsh A. Screening South Indian medicinal plants for antifungal activity against cutaneous pathogens. Phytother Res. 2003; 17:1123–1125. doi: 10.1002/ptr.1399.
10. Wojcik M, Burzynska-Pedziwiatr I, Wozniak LA. A review of natural and synthetic antioxidants important for health and longevity. Curr. Med. Chem. 17, 3262–3288. doi: 10.2174/092986710792231950
11. Yanishelva NV, Marinova E, and Pokorný J. Natural antioxidants from herbs and spices. Eur. J. Lipid Sci. Technol. 2006; 108, 776–793. doi: 10.1002/ejlt.200600127
12. Senthil Kumar M, Sripriya R, Vijaya Raghavan H, Sehgal PK. Wound healing potential of Cassia fistula on infected albino rat model. J Surg Res. 2006 Apr;131(2):283-9. doi: 10.1016/j.jss.2005.08.025
13. Bowler PG, Duerden BI, Armstrong DG. Wound microbiology and associated approaches to wound management. Clinical microbiology reviews. 2001; 14(2), 244–269. doi:10.1128/CMR.14.2.244-269.2001.
14. Giacometti A, Cirioni O, Schimizzi AM, Del Prete MS, Barchiesi F, D'Errico MM, Petrelli E, Scalise G. Epidemiology and microbiology of surgical wound infections. J Clin Microbiol. 2000 Feb;38(2):918-22. doi: 10.1128/JCM.38.2.918-922.2000.
15. Mousa HA, Aerobic, anaerobic and fungal burn wound infections. J Hosp Infect. 1997 Dec; 37(4):317-23
16. Ayyanar M, Ignacimuthu S. Herbal medicines for wound healing among tribal people in South India: Ethnobotanical and Scientific evidences. International Journal of Applied Research and Natural Products. 2009; 2: 29 – 42.
17. Nadkarni KM, Indian Materia Medica. Vol 1. Popular Prakashan, Bombay, India. 1976 p.865
18. Owoyele BV, Adebukola OM, Funmilayo AA. Anti-inflammatory activities of ethanolic extract of Carica papaya leaves. Inflammopharmacology. 2008; 16:168–173 <https://doi.org/10.1007/s10787-008-7008-0>
19. Chew AL, Jessica JJ, Sasidharan S. Antioxidant and antibacterial activity of different parts of Leucas aspera. Asian Pacific journal of tropical biomedicine. 2012; 2(3):176–180. ([https://doi.org/10.1016/S2221-1691\(12\)60037-9](https://doi.org/10.1016/S2221-1691(12)60037-9))
20. Gupta PP, Srimal KL, and Tondon JS. Antiallergic activity of some traditional medicinal plants. Int. J. Pharmacog. 1993; 31: 15-18,
21. Samy RP, Ignacimuthu S. Antibacterial activity of some folklore medicinal plants used by tribals in western Ghats of India. J Ethnopharmacol. 2000; 69(1): 63-71.
22. Perez C, Anesini C. In vitro antibacterial activity of Argentine folk medicinal plants against Salmonella typhi. J Ethnopharmacol 1994; 44(1): 41-46
23. Pal MK. Evaluation of Antihelminthic activity of leaves of Paederia Foetida. Int J Pharma Biosci. 2011; 2(1): 227-231.
24. Mathew KM, An Excursion flora of central Tamilnadu, India. CRC Press. 01-Jun-1995
25. Kanjilal UM, Kanjilal P C, Das A. Flora of Assam, Vol. 1-4. Prabasi Press. Calcutta. (1934–1938).
26. Bergey's Manual of systematic Bacteriology, 1984, Vol 1





**Uma Dutta and Kanyaga Parameshwari**

27. Forbes BA, Sahm DF, Weissfeld AS. Bailey & Scott's Diagnostic Microbiology. 12th ed. St Louis: Mosby; 2007.
28. Barrow GI, Felthman RKA, editors. Cowan and Steel's. Manual for the identification of Medical Bacteria. 3rd ed. Cambridge University Press, Cambridge, U.K. Bary; 1993
29. Perez C, Pauli M, Bazerque P. An antibiotic assay by the agar well diffusion method. Acta Biol Med Exp. 1990; 15: 113-5.
30. Bessa LJ, Fazii P, Di Giulio M, Cellini L. Bacterial isolates from infected wounds and their antibiotic susceptibility pattern: some remarks about wound infection. Int Wound J. 2015; 12: 47-52. doi:10.1111/iwj.12049
31. Serra R, Grande R, Butrico L, Rossi A, Settimio UF, Caroleo B, Amato B, Gallelli L, Franciscis S. Chronic wound infections: the role of Pseudomonas aeruginosa and Staphylococcus aureus, Expert Review of Anti-infective Therapy. 2015;13:5, 605-613. DOI: 10.1586/14787210.2015.1023291
32. Khameneh B, Iranshahy M, Soheili V, Fazly Bazzaz BS. Review on plant antimicrobials: A mechanistic review. Antimicrobial Resistance and Infection Control. 2019;8:118
33. Rajasree PH, Vishwanad V, Cherian M, Eldhose J, Singh R. Extract and evaluation of antiseptic polyherbal ointment. International Journal of Pharmacy and life sciences 2012;3(10):2021-31
34. Talwar G, Raghuvanshi P, Mishra R, Banerjee U, Rattan A, Whaley KJ, Achilles SL, Zeitlin L, Barré-Sinoussi F, David A, Doncel GF. Polyherbal Extracts With Wide Spectrum Antimicrobial Activity Against Reproductive Tract Infections And Sexually Transmitted Pathogens. American Journal Of Reproductive Immunology. 2000; 43: 144-151.
35. Krishnaraj C, Jagan EG, Rajasekar S, Selvakumar P, Kalaichelvan PT, Mohan.N. Synthesis of silver nanoparticles using *Acalypha indica* leaf extracts and its antibacterial activity against water borne pathogens. Colloids and Surfaces B: Biointerfaces. 2010; 76:50–56
36. Singh AR, Bajaj VK, Sekhawat PS, Singh K. Phytochemical estimation and antimicrobial activity of aqueous and methanolic extract of *Ocimum Sanctum* L. J Nat. Prod. Plant Resour. 2013; 3:51-58
37. Goel A. Antibacterial Activity Of Hot Aqueous Extract Of *Ocimum Sanctum* Leaves Against Common Bacterial Pathogens Of Animals.. Pharma Science Monitor. 2012; 3:285-287.
38. Lonkala S, Reddy ARN. Antibacterial Activity of *Carica papaya* Leaves and *Allium sativum* Cloves Alone and in Combination against Multiple Strains. Pharmacog J. 2019;11(3):600
39. Scalbert A. Antimicrobial properties of tannins. Phytochemistry. 1991; 30(12):3875-3883. [https://doi.org/10.1016/0031-9422\(91\)83426](https://doi.org/10.1016/0031-9422(91)83426)
40. Karou D, Savadogo A, Canini A, Yameogo S, Montesano C, Simpore J. Antibacterial activity of alkaloids from *Sida acuta*. Afr. J. Biotechnol. 2006; 5:195–200.
41. Selvan RT, Abdul Khader SM, Sheriff M, Azmathullah NM. Phytochemical screening of *Acalypha indica* L. Leaf extracts. IJABPT. 2012; 3:158-161.

**Table 1: Details of the plants collected**

Sl.No	Botanical name	Family	Common Name	local name	
				Tamil	Assamese
1	<i>Acalypha indica</i>	Euphorbiaceae	Indian Acalypha	Kuppameni	Kuppi
2	<i>Ocimum Sanctum</i>	Lamiaceae	Holy Basil	Tulasi	Tulohi
3	<i>Leucas aspera</i>	Lamiaceae	Thumba	Thumbai	Drumful
4	<i>Carica papaya</i>	Caricaceae	Papaya	Papali	Amita
5	<i>Nyctanthus arbor-tristis</i>	Oleaceae	Night Flowering Jasmine	Parijatam (tamil)	Sewali phul
6	<i>Cassia occidentalis</i>	Caesalpiniaceae	Negro coffee	Payaverai	Medelwa
7	<i>Solanum nigrum</i>	Solanaceae	Black nightshade	Manthakkali	Pokmou
8	<i>Paederia foetida</i>	Rubiaceae	Skunk Vine	Pinarisangai	Vedailota





### Uma Dutta and Kanyaga Parameshwari

**Table 2: Preliminary examination and Growth characteristics of the bacterial Isolates**

TESTS	ISOLATE W1	ISOLATE W2	ISOLATE W3	ISOLATE W4	ISOLATE W5
Preliminary examination					
Gram staining	Gram+ve cocci in clusters	Gram -ve rods	Gram -ve rods	Gram -ve rods	Gram -ve rods
Motility	Non motile	Motile	Non motile	Motile	Motile
Oxidase	-	-	-	-	+
Catalase	+	+	+	+	+
Growth characteristics on NA					
Colony Morphology	Circular, Smooth And Emulsifiable	Thick, greyish, Moist and smooth	Large Mucoid	Swarming	Low Convex, bluish--green

**Table 3: Biochemical profile of the bacterial Isolates**

TESTS	ISOLATE W1	ISOLATE W2	ISOLATE W3	ISOLATE W4	ISOLATE W5
Biochemical tests					
Indole	-	+	-	-	-
Methyl red	+	+	-	+	-
Voges proskaeur	+	-	+	-	-
Citrate utilization	-	-	+	+	+
#Carbohydrate Catabolism	F	F	F	F	F
Urease	+	-	+	+	+
*Triple Sugar Iron Agar	A/A	A/A, G+	A/A, G+	A/K, G+, H2S+	K/K
**Carbohydrate Utilization test					
Glucose	A	AG	AG	AG	-
Sucrose	A	-	AG	-	-
Lactose	A	AG	AG	-	-
Xylose	-	AG	AG	AG	-
Sorbitol	-	AG	AG	-	-
Arabinose	-	AG	AG	-	-
Rhamnose	-	AG	AG	-	-
Mannitol	A	AG	AG	-	-

#O:Oxidative, F:Fermentative \*TSI : A/A-Acid slant and acid butt, no gas, no H2S; G+-Gas produced; K/A: Alkaline slant and Acid butt, no gas, no H2S; k/k-alkaline slant and alkaline butt, no gas, No H2S; H2S+ :H2S produced.\*\*Carbohydrate utilization: A-Acid production only; AG-Acid and Gas production

**Table 4: Secondary tests for the bacterial isolates**

Isolates	Secondary Tests	Result
W1	(i)Tube coagulase (ii)Growth on MSA	Positive for Production of Coagulase Yellow colonies on MSA
W2	Growth on EMB	Colonies with green metallic sheen on EMB
W3	Capsule staining	Presence of Capsules observed
W4	Phenylalanine Deaminase test	Positive for Production Of Phenylalanine Deaminase
W5	Growth on Selective Cetrimide agar	Colonies obtained





**Uma Dutta and Kanyaga Parameshwari**

**Table 5: Identification of the bacterial isolates**

Isolate No	W1	W2	W3	W4	W5
Identified as	<i>Staphylococcus aureus</i>	<i>Escherichia coli</i>	<i>Klebsiella</i> sp.	<i>Proteus</i> sp.	<i>Pseudomonas</i> sp.

**Table 6: Mean zone of inhibition of different concentrations of Plant extracts**

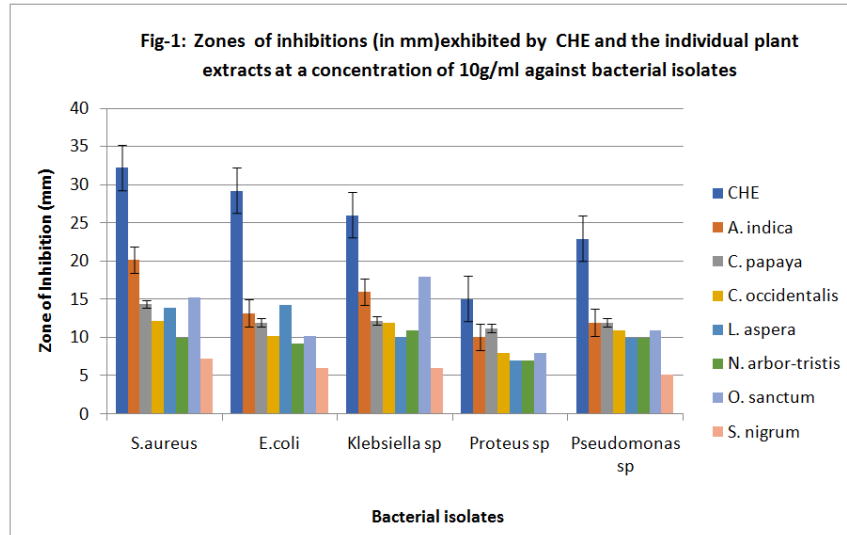
Name of the plant	Extract Concentration mg/ml	Diameter of zone of inhibition(mm) against				
		<i>S. aureus</i>	<i>E. coli</i>	<i>Klebsiella</i> sp.	<i>Proteus</i> sp.	<i>Pseudomonas</i> sp.
Combined Herbal Extract (CHE)	10	**32.3±0.05	**29.3±0.25	**26.1±0.27	**15.1±0.40	**23.0±0.44
	1	**20.3±0.15	**15.0±0.53	**17.2±0.19	*8.0±0.23	**15.2±0.25
	0.5	*12.2±0.24	*10.5±0.32	*11.0±0.07	*5.1±0.06	*10.0±0.02
	0.25	*8.0±0.5	*7.0±0.09	*7.4±0.28	0.0±0.0	*6.0±0.42
<i>Acalypha indica</i>	10	**20.2±0.42	**13.2±0.25	**16.0±0.22	*10.1±0.14	*12.0±0.29
	1	**13.0±0.36	*10.6±0.16	*12.4±0.26	*8.0±0.14	*10.0±0.4
	0.5	*10.2±0.02	*8.0±0.16	*9.0±0.13	0.0±0.0	*7.0±0.20
	0.25	0.0±0.0	0.0±0.0	0.0±0.0	0.0±0.0	0.0±0.0
<i>Caricapapaya</i>	10	**14.4±0.13	*12.0±0.52	*12.2±0.38	*11.2±0.38	*12.0±0.47
	1	*11.0±0.57	*8.3±0.34	*7.0±0.31	*5.1±0.25	*6.3±0.06
	0.5	*7.2±0.27	0.0±0.0	0.0±0.0	0.0±0.0	0.0±0.0
	0.25	0.0±0.0	0.0±0.0	0.0±0.0	0.0±0.0	0.0±0.0
<i>Cassia occidentalis</i>	10	*12.2±0.62	*10.3±0.29	*12.0±0.36	*8.0±0.04	*11.0±0.61
	1	*10.0±0.19	*7.1±0.31	*10.0±0.53	0.0±0.0	*5.0±0.04
	0.5	0.0±0.0	0.0±0.0	*8.0±0.0	0.0±0.0	0.0±0.0
	0.25	0.0±0.0	0.0±0.0	0.0±0.0	0.0±0.0	0.0±0.0
<i>Leucas aspera</i>	10	**14.0±0.09	**14.3±0.63	*10.1±0.49	*7.0±0.42	*10.0±0.45
	1	*10.0±0.04	*8.0±0.46	*5.2±0.40	*5.0±0.57	*7.0±0.34
	0.5	*7.0±0.5	0.0±0.0	0.0±0.0	0.0±0.0	0.0±0.0
	0.25	0.0±0.0	0.0±0.0	0.0±0.0	0.0±0.0	0.0±0.0
<i>Nyctanthes arbor-tristis</i>	10	*10.0±0.17	*9.3±0.26	*11.0±0.24	*7.1±0.31	*10.0±0.40
	1	*8.3±0.29	*5.0±0.51	*9.0±0.05	0.0±0.0	0.0±0.0
	0.5	0.0±0.0	0.0±0.0	0.0±0.0	0.0±0.0	0.0±0.0
	0.25	0.0±0.0	0.0±0.0	0.0±0.0	0.0±0.0	0.0±0.0
<i>Ocimum sanctum</i>	10	**15.3±0.33	*10.2±0.42	**18.0±0.27	*8.0±0.09	*11.0±0.40
	1	*10.0±0.39	*6.0±0.47	*12.2±0.38	*6.0±0.51	*7.0±0.32
	0.5	0.0±0.0	0.0±0.0	7.0±0.06	0.0±0.0	0.0±0.0
	0.25	0.0±0.0	0.0±0.0	0.0±0.0	0.0±0.0	0.0±0.0
<i>Paedria foetida</i>	10	0.0±0.0	0.3±0.02	0.0±0.0	0.0±0.0	0.0±0.0
	1	0.0±0.0	0.0±0.0	0.0±0.0	0.0±0.0	0.0±0.0
	0.5	0.0±0.0	0.0±0.0	0.0±0.0	0.0±0.0	0.0±0.0
	0.25	0.0±0.0	0.0±0.0	0.0±0.0	0.0±0.0	0.0±0.0
<i>Solanum nigrum</i>	10	*7.3±0.45	*6.0±0.36	*6.0±0.29	0.0±0.0	*5.2±0.34
	1	*5.0±0.09	0.0±0.0	0.0±0.0	0.0±0.0	0.0±0.0
	0.5	0.0±0.0	0.0±0.0	0.0±0.0	0.0±0.0	0.0±0.0
	0.25	0.0±0.0	0.0±0.0	0.0±0.0	0.0±0.0	0.0±0.0
Chloramphenicol	0.030	**25.1±0.41	**23.0±0.67	**24.2±0.5	**21.2±0.4	**23.0±0.5

Data are means of 3 replicates (n=3) Mean±Standard Error. \*P<.05, \*\*P<0.01





**Uma Dutta and Kanyaga Parameshwari**



**Fig-1: Zones of inhibitions (in mm) exhibited by CHE and the individual plant extracts at a concentration of 10g/ml against bacterial isolates**







## Learning by Experience: A Continuous Process of Action and Reflection

Atika Srivastava<sup>1\*</sup> and Tanuja Yadav<sup>2</sup>

<sup>1</sup>Research Scholar, Department of Languages, Manipal University Jaipur, Jaipur – 303007, Rajasthan, India.

<sup>2</sup>Associate Professor, Department of Languages, Manipal University Jaipur, Jaipur – 303007, Rajasthan, India.

Received: 08 Dec 2021

Revised: 29 Dec 2021

Accepted: 13 Jan 2022

### \*Address for Correspondence

**Atika Srivastava**

Research Scholar,

Department of Languages,

Manipal University Jaipur,

Jaipur – 303007, Rajasthan, India.

Email: atikasrivastava@gmail.com



This is an Open Access Journal / article distributed under the terms of the **Creative Commons Attribution License** (CC BY-NC-ND 3.0) which permits unrestricted use, distribution, and reproduction in any medium, provided the original work is properly cited. All rights reserved.

### ABSTRACT

The teaching and learning methodologies of French as a foreign language (FLE) evolve according to the imperative needs of experts, teachers, and learners. The Conventional methodology of the teaching of FLE is mainly based on the transfer of knowledge to learners, but this does not take into account individual progression. This methodology is based on the social context and real situations. However, the continuous progression of skills requires a sustained effort in the practice of French. For this, we rely on the experiential method, a new method for the acquisition of procedural and conceptual knowledge. Learning by experience relies heavily on the learner's commitment to the process acquiring knowledge and the link between personal needs or social networks and the knowledge of the content as they inform and mutually transform. This article focuses on identifying the concept of learning by experience, its principles and criteria, its weaknesses, and its strengths. Experiential learning is participatory, interactive, and applied.

**Keywords:** Experiential learning, reflection, French as a foreign language

### INTRODUCTION

Dan was gifted a pair of skates by his parents on his 14<sup>th</sup> birthday. Not fancy with the skills of this sport, he enrolled himself for classes on "how to skate". On the first two days of his class, Dan managed to falter six times (each day), as he fell at regular intervals. On the third day however, Dan fumbled only thrice. So, what do you think made the difference on day number 3.



**Atika Srivastava and Tanuja Yadav**

Was it a typical case of "Practice makes a man perfect"?

Was it improvement via the "Trial and error" method?

To a certain extent, yes. Both the above-mentioned factors played a crucial role in Dan's development as a skater. But one role that we haven't yet factored in is that of Dan's coach (let's call him Bob). Bob visually experienced Dan's skating abilities and made a note of the areas where he erred. He then discussed with Dan and made him reflect upon his recent experience as a novice skater and guided him accordingly to improvise on the areas of concern. "Increased learning will occur if the specialist uses a learner centered approach, where facilitators utilize learner's experiences and knowledge in learning process and where they develop methods in which the learner interacts with and reflects on the subject matter" – Enns, 1993; Kolb, 1984. The above approach to learning is based on experiential learning theories and methodologies. Experiential learning basically is the "umbrella" term for learning by actions, by doing, with discreet experiences, and with exploration. With respect to this mode of learning, experience does not transform into learning unless it is reflected upon and made more meaningful. "Experience is incomplete without assessing it" – Saddington, 2001.

**Definition**

"Experiential Learning is a philosophy and methodology in which educators consciously engage with students in direct experiences and focused reflection in order to increase knowledge, develop skills, and clarify values" – The Association for Experiential Education, 1994.

Thus, we can concur that experiential learning incorporates the two major attributes: -

**Actions:** Experiential learning involves a direct bearing with the phenomena under consideration of this study instead of merely focusing on abstract concepts. It combines actual experience with phenomena to support the concept.

**Reflection:** An action succeeded by reflection is a must for learning to occur. Reflection involves the learner observing, reliving, recreating, and re-evaluating his/her experience in order to work upon the same and convert it into learning. An important point to note here is that reflection is not merely envisioning the experience; it must be followed up with a goal in mind. Reflection is a process where feelings and cognition blend together in proportion.

**Delving Deeper into the Roots of Experiential Learning**

Experiential learning was established as an accepted field of education right from 1970s. In 1977, the Association for Experiential Education (AEE) was established. The work of noted American philosopher, John Dewey on learning through experiences laid the foundation in the formal education scenario. Dewey also challenged educators in the 1910's, the 20's and the 30's to develop educational programs based on real life experience. As emphasized by Dewey (also known as the modern father of the pedagogy of experiential learning) in the late 19<sup>th</sup> century, humans act upon an experience, creating a consequence. When we do something, something happens to us in return. How an individual connects these two occurrences evaluates the true value of the experience. Kurt Lewin (the father of modern social psychology), famous for his action-research methodology and for his professional involvement with T-Groups, and sensitivity training, firmly believed that theory and practice go side by side. He is one of the authorities on sculpting the genesis of experiential learning. The theory of experiential learning gained philosophical support from theoreticians, who collectively represented a constructivist view of knowledge and learning. This constructivist view denotes those experiences that allow learners to conceive the meaning of the world around them.

**David Kolb ~ Introducing the Learning Cycle**

According to Kolb, experiential learning contains: -

Concrete Experience

Observation and Reflection

Formation of Abstract Concept

Active Experimentation



**Atika Srivastava and Tanuja Yadav**

According to this four-stage cycle (now well recognized), the immediate or the concrete experiences are foundations of observations and reflections. Reflection is crystalized into abstract concepts with which new implications for actions can be sketched. These implications serve as yardsticks in creating new experiences. According to Kolb, a learner should cycle through these four parts, thus making a “learning spiral” of ever-increasing complexity. Kolb stresses that humans are not “empty organisms”, on the contrary they have past experiences that help them to learn proactively

**Rising Above the Conventional Education System**

In the times of today, teaching and training in education continues to be conventional, theoretical, and highly prescribed .textbooks, direct instructional approaches, desks, whiteboard, fixed curriculum, content centered, transfer of pre-determined skills knowledge, rote memorization are the typical features of conventional prescriptive teaching methods. The most practiced mode of education worldwide i.e., traditional prescriptive method of education pushes us to question ourselves: Does conventional chalk and talk method offers us fully, a truly well-rounded education? What is the crucial missing element here? The response is imperative connection to real world. To fulfill this missing element, we can look forward to experiential learning as a remedy. Classroom based experiential learning methods are better than just the traditional methods of lectures, discussions or even demonstrations. They are active, experience based, and related to an individual's previous and forthcoming experiences. Experiential learning methods takes learning beyond classrooms on the account of its strengths such as student centered, indirect instructional approaches, personalized learning, flexible open possibilities, construction of knowledge and skills, etc. Experiential learning incorporated with traditional methods of teaching and learning, provides opportunities for individual growth which culminates in increased engagement, increased confidence, sense of purpose and motivation. In short, experiential learning makes learners ready to embark into real world workplace, having developed cultural and educational competency.

**Administering Experiential Learning to Foreign Language Education**

Experiential learning is soon evolving to be a widely accepted approach to learning that is irrespective of the field of education. Whether it is the domain of science, management, architecture, or even geography for that matter, experiential learning has proven to be effective. And the benefits of incorporating this technique into foreign language teaching hold no disparity. In the present scenario, considering a foreign language-learning environment just as means of acquiring linguistic proficiency and harnessing good communication skills are not enough. A foreign language-learning environment should also stand as a valuable resource for the entirety of human growth, including the possibility to broaden one's perspective by being open to understanding different patterns of thoughts, cultures and societies associated with different customs and traditions. But this is easier said than done as the conventional curricular approach and material have manifested rather ineffectual in supporting this endeavor. Identifying a robust alternative through theoretical based practical approach that can help infuse a communicative and cultural competence in students more meaningfully, has been a challenge. Keeping this in mind, experiential learning with stress on critical self-reflection is a beneficial approach for aiding the learners in terms of gaining motivation and a thorough understanding of the culture. Thus, experiential learning is a vital and effective tool required to redesign foreign language education.

**Introducing Experiential Language to French Language Teaching**

French classes today are structured differently from the conventional grammar translation classes. The teaching practices of the French language are currently focused more on task-based learning. The language is being taught in a more natural learning environment. Task-based learning relies on the concept that language learning is more simplified when students are cooperatively dealing with a project or a task. It emphasizes on the use of authentic language through purposeful tasks such as a visit to the marketplace, telephone call to a friend, etc. These real-life situation-centered activities encourage more meaningful communication and are student oriented. The Council of European French Reference's (CEFR) action aligned approach stresses on the use of language to perform tasks to achieve a goal. In practice, task-based learning transforms into experiential learning when components of



**Atika Srivastava and Tanuja Yadav**

“reflection”, “facilitation” and “transfer” are added to the simple experiences, thus transforming a simple activity into a cherished opportunity for learning.

**Enhancing French Language Teaching the Experiential Way**

The traces of experiential learning elements are already visible in teaching and learning of French as a foreign language via study abroad programs, role plays, simulations, and games. However, there are certain elementary steps to be followed when integrating experiential learning in the teaching and learning of French as a foreign language. They are:

**Planning:** The activities should be carefully selected and planned in such a way that they challenge the learners by problem solving, assistance, self-discovery, and self-reflection. Learners should be initiated into activity in a manner that activates their background schema. A well-structured exposure phase also clearly lays out for learners, pedagogical purpose and rational for task and can lead to greater learners' involvement in their own learning process (Nunan, 1995)

**Facilitation:** As Richard (2001) stated that the student learns the languages by interacting communicatively and purposefully while engaged in activity and task, teachers as facilitators, ensure that student involves personally to build on or to enhance the previous experiences. The student, during his entire learning process, participates actively by posing questions, experimentation, curiosity, conceiving meaning and therefore being creative.

**Assessment:** Achievement of the experiential learning activities can be assessed during discussions, probing session, and constructive feedback. Investing time on debriefing sessions gives the chance to students to personalize the lessons and determine their level of understanding. Skillful questioning by the facilitators helps the learners to reflect on their discoveries and connecting it to the past experiences which can be used as an evolving context. Facilitators in this reflective process draws the attention of the students towards their emotions and feelings and participation in language learning experience.

**Crossing the hurdles**

Proficiency in French as a foreign language is now based on notional functional task founded in real life situations rather than depending on knowledge of grammatical forms. However, adapting the experiential learning methods to current French pedagogy is a challenging task. The instructors and the learners experience success, non-fulfillment, adventure, risk taking, and uncertainty since the outcomes of experiences cannot completely be predicted. This learning method suggests that the learner must occupy the center stages of classroom activity and not the teacher. Thus, the preparedness to undertake a less teacher centric role in the classroom often becomes a challenge for a teacher. As the student comes with varied experiences and maturity levels, students with less prior knowledge might express frustration. Such students tend to lapse into their mother tongue and look for more structured settings to demonstrate themselves as better performers. Activities based on experiential learning methodologies also tend to take on life of their own. As they are time consuming, width of the material remains uncovered. Inadequate student teacher ratio also poses the problems of class management which results in unsuccessful conduction of the activities. However, with reflective- type class sessions, certain difficulties can be counteracted. Reflective mechanism in experiential learning can help the student to explore their issues and come out with the solutions. A well conducted debriefing session shall also serve as a remedy. In fact, the experiential learning activities in conjunction with the traditional methods of education shall allow the learners to stretch in a unique and creative direction, enabling them to form the positive identities of themselves as successful language learners.

**CONCLUSION**

Considering how teaching and learning methodologies have evolved and progressed over time signifies the importance to imbibe innovative and out-of-the-box growth strategies in our education system. This proposition is consistent across all spheres, including that of the French language education system. Both, teachers with an





**Atika Srivastava and Tanuja Yadav**

unprecedented approach to teaching, and students with a responsible zeal towards learning are important in building up a healthy environment for effective schooling of the French language. But more importantly, it is adapting to newer and proven methodologies that holds the key in the progressive development of French language education. Keeping the aforesaid in mind, experiential learning with stress on critical self-reflection demonstrates a key function in the transformation of present-day teaching and learning methodologies and in shaping up a better future for French as a foreign language.

**REFERENCES**

1. Dewey, J. Experience and education. New York: Macmillan, 1938.
2. Kolb, D. A. Experiential learning: Experience as the source of learning and development. Englewood Cliffs, NJ: Prentice-Hall, 1984
3. Kolb, D., & Fry, R "Toward an applied theory of experiential learning" Theories of group processes, London: John Wiley, 1975, pp. 33-57.
4. Knutson, S. "Experiential Learning in Second-Language Classrooms". TESL Canada Journal, Vol. 20, no. 2, June 2003, pp. 52-64, doi:10.18806/tesl.v20i2.948.
5. Rogers, C. R. On becoming a person. Boston: Houghton Mifflin, 1961.





## Study on Properties of Translucent Concrete and Mortar for Natural Lighting Inside Buildings

Sabapathy Y.K<sup>1</sup>, Vishnu Aravind G<sup>2</sup>, Sathya Shree T R<sup>3\*</sup> and Shaleni Elam Thendral A<sup>3</sup>

<sup>1</sup>Professor, Department of Civil Engineering, SSN Institutions, Tamil Nadu, India.

<sup>2</sup>Alumni, Department of Civil Engineering, SSN Institutions, Tamil Nadu, India.

<sup>3</sup>Student, Department of Civil Engineering, SSN Institutions, Tamil Nadu, India.

Received: 06 Nov 2021

Revised: 20 Dec 2021

Accepted: 10 Jan 2022

### \*Address for Correspondence

**Sathya Shree T R**

Student,

Department of Civil Engineering,

SSN Institutions, Tamil Nadu, India.

Email: sabapathyk@ssn.edu.in



This is an Open Access Journal / article distributed under the terms of the **Creative Commons Attribution License** (CC BY-NC-ND 3.0) which permits unrestricted use, distribution, and reproduction in any medium, provided the original work is properly cited. All rights reserved.

### ABSTRACT

Lighting consumes a fifth of the world's electricity consumption, such as in high-rise buildings which generate considerable lighting demands even during daylight hours. This resulted in the invention of an innovative, productive, and sustainable building material based on the LTC technology, which used to harness the vast quantity of potential energy in sunlight. It also helps to reduce the negative impression of concrete as a material that is grey, dark, harsh, rigid and opaque and focuses on the fundamental idea of creating an eco-friendly, aesthetic and energy-saving material. By adding transparent material to concrete, LTC is developed, which influences its key characteristics. This transparent or translucent alternative material makes it possible for light to pass through the concrete. The goal of this research is focussed on the compressive strength and transmissibility of concrete and cement mortar, with a deep dive into the properties of fibres and their effect on the mentioned properties.

**Keywords:** Light Transmitting Concrete/Mortar, Optical fibres, Aspect ratio, Compressibility, Transmissibility.

### INTRODUCTION

Advanced infrastructure development has made concrete the most widely and commonly used building material around the world. Growing demand for infrastructure has developed enormous pressure to generate big quantities of concrete in the construction sector. With a substantial rise in the growth of modernization in the construction industry, one of the industry's progresses is the incorporation of optical fibers in concrete to create a type of concrete known as Light Transmitting Concrete (LTC) or translucent concrete. It is one of the construction industry's recent developments which successively gains popularity, is used to produce environmentally friendly and bright building



**Sabapathy et al.,**

material. The transparent or translucent alternative material makes it possible for light to pass through the concrete. LTC efficiency is comparable to slits, allowing light to be transmitted through a concrete body. Its main purpose is to use sunlight as a source of light to reduce the energy consumption of lighting and can be used for a wide range of applications including floors, pavements, load-bearing walls, furniture, facades, interior wall cladding, and partition walls. LTC consist of cement, fine aggregate, coarse aggregate, water and optical fiber which transmits the light. The optical fiber in LTC accounts for 2% to 6% of the concrete quantity.

The main objective of this paper is to analyse the compressive strength and transmissibility properties of translucent concrete with variation in the aspect ratio of the optical fibres used. In total 12 concrete cube specimens and 12 mortar cube specimens were fabricated for three different diameters of optical fiber – 0.75mm, 1mm and 1.5mm respectively and tested for compressive strength. In addition to this, 18 concrete cube specimens and 18 mortar cube specimens were fabricated for testing of luminosity and light transmissibility in both natural and artificial sources respectively.

## MATERIALS AND METHOD

### Concrete and Mortar

The light transmitting concrete was prepared using cement, water, sand, and optical fiber. Tap water was used for the preparation and curing of the specimens. The concrete mix made was according to the Indian codal provisions [10]. M25 grade of concrete was prepared. The details of the materials used are specified in Table 1 and the mix designs of concrete and mortar are specified in Table 2 and Table 3.

### Preparation of optical fibre

Three different diameters of optical fibers – 0.75mm, 1mm and 1.5mm respectively were chosen for this experimental study. A customised mould was fabricated to insert the POF during casting of concrete with ease. The mould was made up of three plywood pieces with a plywood base plate. Two opposite faces of aluminium sheets were drilled at a uniform spacing of the previously calculated spacing for their respective diameter to hold the optical fibres in place. The optical fibres were cut into pieces of sufficient length and placed individually through the holes in the two plywood sides facing opposite to each other. Weight batching was adopted for measuring the proportions of materials (as per the mix design). Fibers were placed in layered distribution as the organized distribution provides good reflection properties. Several holes were driven on the mould so that the optical fibers can pass through them in an organized manner as shown in Fig. 1.

### Casting and curing of concrete and mortar cube specimens

Conventional concrete and mortar specimens are made using standard cube specimens of dimensions 150 x 150 x 150 mm and 100 x 100 x 100 mm respectively. Nine wooden fabricated moulds with plywood and metal sheet are inspected for defects and openings and plastered, sealed and hammered into the required dimension with high accuracy. The plywood mould was then polished with sandpaper and provided with releasing sheets. The layers of fibres were placed from bottom to top with each lower layer being sealed off with a stopper using high strength adhesive subsequently. Concrete mix was then placed into the mould after placement of fibres. Gentle tamping was done during the placing of concrete with high care ensured to not damage the fibres and this was followed by small flicks to ensure uniform settlement of concrete. Then, the cube was agitated on table vibrator for two minutes. The same procedure was followed for placing the cement mortar in the fabricated moulds. All the specimens are cured in water at a temperature maintained at 15° - 20° Celsius.

### Testing of specimens

#### Compression test

In the compressive strength specimens, the fibres are arranged parallel to each other in a systematic manner. The compression test is done to evaluate the press behaviour of the translucent fibre pieces. The optical fibres in the





translucent blocks are cables in the compression test when the load was applied perpendicularly to the fibres which simulates the same force exerted by the fibres on each other. Similarly, the compression test on mortar samples was aimed to evaluate the influence of POF on the mortar mix. The compressive strength test was performed using the Universal Testing Machine (UTM). The compressive strength of the concrete and the mortar specimens were calculated using the formula:

$$F = P/A$$

Where  $F$  is the compressive strength,  $P$  is the applied load and  $A$  is the loaded surface area.

### Transmissibility Test

For the measure of transmissibility and luminosity, lux meter was used for this test. A lux meter is a device which measures the intensity of light falling on its' sensor. This reading differs from the measurement of the actual light energy produced by a light source. It works by using a photocell to capture light, which is then converted to an electric current and finally it gives the lux value. In case of testing under ambient sunlight the specimen is aligned in the direction of sunlight free from obstacles. The light meter is set for the required range as per the luminosity of light up till a value of 200000 lux and the sensor is cleaned and opened. The value is recorded after there are negligible fluctuations in the reading. Further, the luminosity of light through ambient air is recorded. Transmissibility of the specimen is thereby computed using the known luminosity values in air and through the specimen. This is used for the measurement between various diameter of fibers used for comparison.

The equation of transmissibility is as follows:

$$T = L_s/L_o$$

Where  $T$  is the transmissibility,  $L_s$  is the Luminosity measured through the sample and  $L_o$  is the luminosity measured through air.

## RESULTS AND DISCUSSION

The results obtained in the tests are presented below as tables and graphs, and the influence of the variables is studied and analysed. For each test, a statistical analysis was done to verify the effect of these optical fibres in the translucent concrete to determine the significant differences in affecting the property using ANOVA test.

### Compression test

The average compressive strength test performed at 28 days and the results are shown in the table. The variation in the compressive strength of concrete and the mortar specimens are shown below.

### Compressive Test Results for Concrete Samples

The compressive strength of the concrete samples is mentioned in Table 4 and accounted for deviation and coefficient of variation in Table 5. The ANOVA statistical significance test is carried out in Table 6 and the summarized average compressive strength across concrete samples and its deviation is shown in Fig. 3.

### Compressive Test Results for Cement Mortar Samples

The compressive strength of the cement mortar samples is mentioned in Table 7 and accounted for deviation and coefficient of variation in Table 8. The ANOVA statistical significance test is carried out in Table 9 and the summarized average compressive strength across cement mortar samples and its deviation is shown in Fig. 4.

### Luminosity and Transmissibility- Natural source

Luminosity of light passing through the translucent concrete / mortar with varying diameter is placed along the direction of the sun rays and the initial reading is through air with a fixed distance. The Luminosity reading in the Light Meter through air is 4100 lux. The variation in the transmissibility through concrete and the mortar specimens are shown below.





**Sabapathy et al.,****Luminosity and Transmissibility for Concrete Samples**

The luminosity and transmissibility of the concrete samples is mentioned in Table 10 and accounted for deviation and co-efficient of variation in Table 11. The ANOVA statistical significance test is carried out in Table 12 and the summarized average transmissibility across concrete samples and its deviation is shown in Fig. 5.

**Luminosity and Transmissibility Test for Cement Mortar Samples**

The luminosity and transmissibility of the cement mortar samples is mentioned in Table 13 and accounted for deviation and co-efficient of variation in Table 14. The ANOVA statistical significance test is carried out in Table 15 and the summarized average transmissibility across cement mortar samples and its deviation is shown in Fig. 6.

**CONCLUSION**

The above study establishes the correlation between the strength of the specimen and the variation of the aspect ratio of the fibre with total constant volume of fibre in the mixture. A significant increase in strength is noted in the cement mortar specimen with 1.5mm fibre sample with improved transmissibility and luminosity, whereas the maximum strength occurred while using 1mm optical fibre in the concrete specimen, with strength similar to the conventional mix, and maximum transmissibility and luminosity. In addition to the variation of strength with the aspect ratio of the fibre, a direct correlation can be observed between the specimens with the maximum compressive strength and luminosity provided, as demonstrated by concrete with 1 mm optical fibres and cement mortar with 1.5mm optical fibres providing maximum compressive strength, luminosity, and transmissibility of natural light. This in turn would provide a compelling use of translucent concrete as an innovative, productive and sustainable green-building material achieving its main purpose in the use sunlight to reduce the energy consumption, without compromising on the strength of the structure.

**REFERENCES**

1. M. L. Kolhe et al. (eds.), *Smart Technologies for Energy, Environment and SustainableDevelopment*, Lecture Notes on Multidisciplinary Industrial Engineering, [https://doi.org/10.1007/978-981-13-6148-7\\_25](https://doi.org/10.1007/978-981-13-6148-7_25)
2. Abdel Majeed Altomate, Faesal Alatsshan, Fidelis Mashiri & Mohamed Jadan (2016) Experimental study of light-transmitting concrete, *International Journal of Sustainable Building Technology and Urban Development*, 7:3-4, 133-139, DOI: 10.1080/2093761X.2016.1237396
3. R. Bajpai, Application of transparent concrete in construction world, *i-Manager's J Civ Eng*. 4 (2013), pp. 13–18.
4. A. Sawant, R. Jugdar, S. Sawant, *Light transmitting concrete by using optical fiber*, *Int J Eng. Sci* 3 (2014), pp. 23–28.
5. B.F. Bashbash, R.M. Hajrus, D.F. Wafi, and M.A. Alqedra, *Basics of light transmitting concrete*, *Global Adv Res J Eng*. 2 (2013), pp. 076–083.
6. S.A. Salih, H.H. Joni, S.A. Mohamed, M.M. Hamadi, A.B. Abdulghafour, H.N. Uгла, M.Y. Fattah, K.H.I. Al Helo, Z.I. Qasim, A.H.M.J. Al Obaidy, *Effect of plastic optical fiber on some properties of translucent concrete*, *Eng Tech J* 23 (2014), pp. 2846–2861.
7. Byoungil Kim, Light Transmitting Lightweight Concrete with Transparent Plastic Bar, *The Open Civil Engineering Journal*, 2017, 11, 615-626
8. Yue Li a, Jiaqi Li, Yuhong Wanc, Zhiyuan Xu, Experimental study of light transmitting cement-based material (LTCM), *Construction and Building Materials* 96 (2015) 319–325
9. Thiago dos S. Henriques †, Denise C. Dal Molin, Ângela B. Masuero, Study of the influence of sorted polymeric optical fibers (POFs) in samples of a light-transmitting cement-based material (LTCM), *Construction and Building Materials* 161 (2018) 305–315
10. IS10262 : 2019 - Concrete Mix Proportioning - Guidelines





**Sabapathy et al.,**

**Table 1. Properties of materials**

Type of cement used	PPC Grade 53
Specific gravity of cement	2.9
Specific gravity of coarse aggregate	2.83
Specific gravity of fine aggregate	2.54
Water absorption of coarse aggregate	0.5%
Water absorption of fine aggregate	1%
Free surface moisture of coarse aggregate	Nil
Free surface moisture of fine aggregate	Nil

**Table 2. Concrete mix properties**

Materials	Kg/m <sup>3</sup>	Ratio	Per cube kg
Coarse aggregate	863	2.07	0.97
Fine aggregate	904	2.17	1.02
Cement	416	1	0.47
Water	2081	0.5	0.23

**Table 3. Mortar mix properties**

Materials	Kg/m <sup>3</sup>	Ratio	Per cube kg
Fine aggregate	1905	2.43	2.14
Cement	786	1	0.89
Water	3931	0.5	0.45

**Table 4. Compressive test results for concrete samples**

S. No	Sample Name	Strength (MPa)	Average (MPa)
1	A1	29.6	29.22
2	A2	28.28	
3	A3	29.79	
4	B1	18.39	22.81
5	B2	24.60	
6	B3	24.45	
7	C1	29.79	29.16
8	C2	25.78	
9	C3	31.93	
10	D1	24.64	25.12
11	D2	24.34	
12	D3	26.24	

A: Conventional concrete | B: 0.75 mm fibre sample | C: 1 mm fibre sample | D: 1.5mm fibre sample





**Sabapathy et al.,**

**Table 5. Average compressive strength of concrete with and without addition of fibers**

Sample	Average compressive strength (MPa)	Standard deviation	Standard error	Coefficient of variation (%)
<b>A</b>	29.22	0.82	0.47	2.81
<b>B</b>	22.81	1.11	2.23	4.43
<b>C</b>	29.16	3.12	1.80	10.71
<b>D</b>	25.12	3.85	0.64	16.87

**Table 6. ANOVA (One-Way) of the average compressive strength of concrete**

Source	SS	DF	MS	F	Sig
<b>Factor</b>	89.93	3	29.98	4.52	0.039
<b>Error</b>	53.03	8	6.63		
<b>Total</b>	142.96	11			

SS: Sum of Squares; DF: Degree of Freedom; MS: Mean sum of squares; F: Test Statistic; S- Significance level

**Table 7. Compressive test results for mortar samples**

S. No	Sample Name	Strength (MPa)	Average (MPa)
1	E1	30.82	30.01
2	E2	28.80	
3	E3	30.30	
4	F1	30.09	31.73
5	F2	34.60	
6	F3	30.50	
7	G1	33.0	32.30
8	G2	31.96	
9	G3	31.93	
10	H1	27.71	33.59
11	H2	36.66	
12	H3	36.40	

E: Conventional mortar | F: 0.75 mm fibre sample | G: 1 mm fibre sample | H: 1.5mm fibre sample

**Table 8. Average compressive strength of mortar with and without addition of fibres**

Sample	Average compressive strength (MPa)	Standard deviation	Standard error	Coefficient of variation (%)
<b>E</b>	30.01	1.09	0.63	3.63
<b>F</b>	31.73	2.49	1.44	7.85
<b>G</b>	32.30	0.61	0.35	1.89
<b>H</b>	33.59	5.09	2.94	15.15





Sabapathy et al.,

Table 9. ANOVA (One-Way) of the average compressive strength of mortar

Source	SS	DF	MS	F	Sig
Factor	19.88	3	6.63	0.79	0.54
Error	67.45	8	8.43		
Total	87.33	11			

SS: Sum of Squares; DF: Degree of Freedom; MS: Mean sum of squares; F: Test Statistic; S- Significance level

Table 10. Transmissibility test results for concrete samples

Sample	Natural Luminosity (lux)	Average natural luminosity (lux)	Natural Transmissibility (%)	Average transmissibility (%)
B1	198	219	4.82	5.34
B2	235		5.73	
B3	224		5.46	
C1	224	254	5.46	6.19
C2	270		6.58	
C3	268		6.53	
D1	230	247	5.60	6.01
D2	250		6.09	
D3	260		6.34	

B: 0.75 mm fibre sample | C: 1 mm fibre sample | D: 1.5mm fibre sample

Table 11. Average natural transmissibility of concrete

Sample	Average natural transmissibility	Standard deviation	Standard error	Coefficient of variation (%)
B	5.34	0.47	0.27	8.80
C	6.19	0.63	0.37	10.18
D	6.01	0.37	0.22	6.16

Table 12. ANOVA (One-Way) of the average natural transmissibility of concrete

Source	SS	DF	MS	F	Sig
Factor	1.21	2	0.607	2.39	0.17
Error	1.52	6	0.253		
Total	2.73	8			

SS: Sum of Squares; DF: Degree of Freedom; MS: Mean sum of squares; F: Test Statistic; S- Significance level

Table 13. Transmissibility test results for mortar samples

Sample	Natural Luminosity (lux)	Average natural luminosity (lux)	Natural Transmissibility (%)	Average transmissibility (%)
F1	3500	3833	3.91	4.28
F2	4000		4.46	
F3	4000		4.46	





**Sabapathy et al.,**

G1	3700	4133	4.13	4.61
G2	4500		5.02	
G3	4200		4.69	
H1	5100	5267	5.69	5.88
H2	5400		6.03	
H3	5300		5.92	

F: 0.75 mm fibre sample | G: 1 mm fibre sample | H: 1.5mm fibre sample

**Table 14. Average natural transmissibility of mortar**

Sample	Average natural transmissibility	Standard deviation	Standard error	Coefficient of variation (%)
F	4.28	0.32	0.18	7.47
G	4.61	0.45	0.26	9.76
H	5.88	0.17	0.10	2.89

**Table 15. ANOVA (One-Way) of the average natural transmissibility of mortar**

Source	SS	DF	MS	F	Sig
Factor	4.29	2	2.14	19.30	0.002
Error	0.67	6	0.11		
Total	4.96	8			

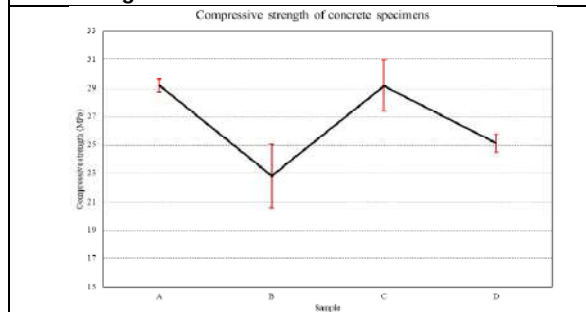
SS: Sum of Squares; DF: Degree of Freedom; MS: Mean sum of squares; F: Test Statistic; S- Significance level



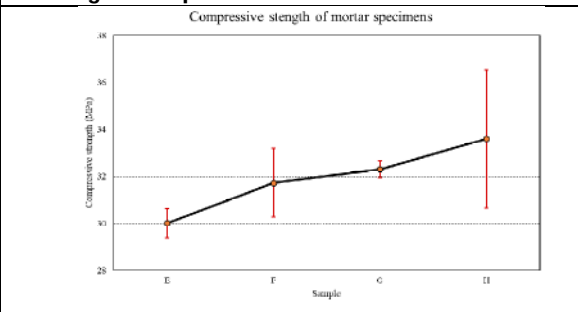
**Fig. 1. Placement of fibres in the mould**



**Fig. 2. Sample of concrete with 1mm diameter**



**Fig. 3. Average compression strength of concrete samples**



**Fig. 4. Average compression strength of mortar samples**





Sabapathy *et al.*,

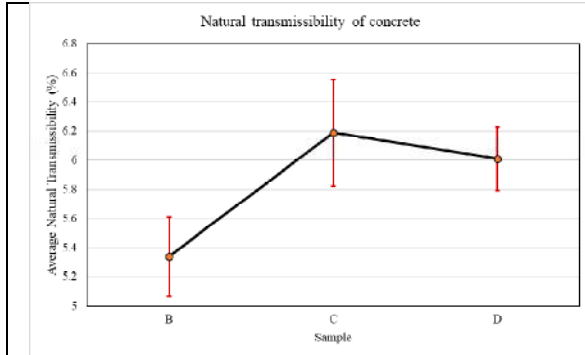


Fig. 5. Average transmissibility of concrete samples

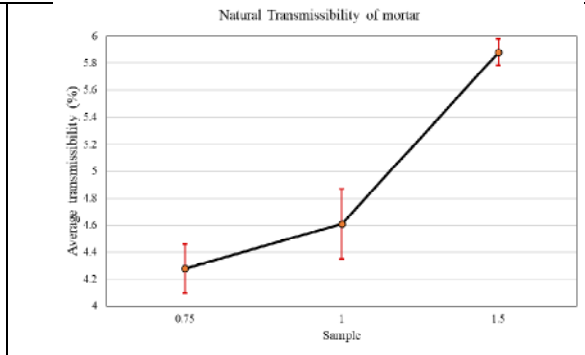


Fig. 6. Average transmissibility of mortar samples





## Effectiveness of Respiratory Exercises and Abdominal Strength Training Program on Pain, Abdominal Strength & ADL of Post-Operative Abdominal Surgeries: A Pilot Randomised Controlled Trials

Anjan Desai<sup>1\*</sup> and V.P. Hathila<sup>2</sup>

<sup>1</sup>Ph.D Scholar, Principal in Charge, SPB Physiotherapy College, Surat, Gujarat, India.

<sup>2</sup>Dean, Faculty of Medicine, Parul Institute of Medical Sciences & Research, Parul University, Waghodia, Vadodara, Gujarat, India

Received: 23 Nov 2021

Revised: 20 Dec 2021

Accepted: 12 Jan 2022

### \*Address for Correspondence

**Anjan Desai**

Ph.D Scholar, Principal in Charge,

SPB Physiotherapy College,

Surat, Gujarat, India.

E.Mail: anjandesai@gmail.com



This is an Open Access Journal / article distributed under the terms of the **Creative Commons Attribution License** (CC BY-NC-ND 3.0) which permits unrestricted use, distribution, and reproduction in any medium, provided the original work is properly cited. All rights reserved.

### ABSTRACT

Surgery has become an integral part of global health care for the better health and quality of life of people with disease burden. In spite of proven physiotherapy benefits, strength training along with the respiratory exercises has fundamental importance to physical therapists; as this knowledge will help them to select the best interventions for patients submitted to post-operative abdominal surgeries. This pilot RCT aimed to find out the effectiveness of respiratory exercises along with abdominal strength training in post operative abdominal surgery patients on pain, abdominal strength and activities of daily living. Pilot study was conducted on 57 post operative abdominal surgeries patients from various hospitals in Surat. Pain, Abdominal strength and ADL were checked on the day of operation and at one month post operatively by VAS, Chattanooga pressure biofeedback and Barthel index respectively. Along with normality testing inter group and intra group comparison was done by Mann Whitney U test and Wilcoxon signed rank test. Both groups showed significant improvement in all variables along with experimental group showed significant improvement ( $p < 0.000$ ) in all variables. The study concluded respiratory as well as abdominal strength training exercises in patients with post operative abdominal surgeries are effective in reducing pain and improving abdominal strength and ADL.

**Keywords:** Post operative abdominal surgeries, abdominal strength training, respiratory exercises, abdominal strength, Pain, AD



**Anjan Desai and Hathila**

## INTRODUCTION

The successes of society in terms of education, urbanization, industrialization and innovation, not in the least in healthcare, have led to an increasing population. This still expanding generation should be able to participate in society for as long as possible. However, which makes them vulnerable to reduced functioning and societal participation.[1] Due to gradually diminishing physical activity, Major life events like hospitalization and surgery can further compromise their functional status and activities of daily living.[2] This decrease in adaptive capacity can be reduced by recent medical innovations and can be reduced more or possibly even prevented by physical exercise training and maintaining physical activity in the course of an event.[3] A significant proportion of the population has undergone one or the other forms of surgical procedures at one or more points in the life time of an individual. As a part of global health care, 234 million surgeries performed yearly. The World Bank in 2002 reported that an estimated 164 million disability-adjusted life years, representing 11% of the entire disease burden, were attributable to surgically treatable conditions.[4] Abdominal surgery is defined by any surgical operation on abdominal organs, including the stomach, gallbladder, small intestine, large intestine, appendix, liver, pancreas, spleen, esophagus and appendix. It is known that surgical procedures in the upper abdominal area promote changes in pulmonary function and respiratory mechanics, leading to postoperative pulmonary complications (PPCs). Some of the main changes that lead to PPCs are decreased diaphragm mobility, depressed central nervous system, and changes in the ventilation-perfusion ratio, reduced cough efficacy, increased respiratory rate, reduced pulmonary volumes and capacities, pain and weakness in the abdominal muscle [5]. The most common complications due to these changes are atelectasis, hypoxemia, and pneumonia, which can affect up to 80% of patients submitted to abdominal surgery, which may lead to increasing the length of hospital stay and treatment costs and contributing significantly to mortality.[6] In open abdominal surgeries sometimes general anaesthesia has effects on lungs, and together with the pain from your wound, makes taking a deep breath and coughing difficult. This means that thick mucus can collect in the lungs. Abdominal wall paresis is a complication of laparotomy surgery due to lesions of the intercostals nerves in which after subcostal laparotomy, paresis of the rectus abdominis muscle and bulging of the abdominal wall [7]. Moreover, every laparotomy is followed by several days of discomfort, but postoperative pain varies greatly among patients [8]. Such discomfort may include ordinary abdominal wall pain due to cutting and retraction of nerves and muscles, distention of the gastrointestinal tract because of ileus, an almost invariable accompaniment of intra abdominal surgery and pain due to some internal postoperative complication or disease, such as bleeding, infection, or drainage.[9] The focus of problems with the surgeries is exaggerated parietal wall pain. In previous study found that Impaired Recovery of Strength in Older Patients after Major Abdominal Surgery and that causes; their strength falls to lower levels after surgery and their postoperative recovery of strength is impaired. [9] Routinely used physiotherapy in clinical practice aims to prevent the post operative complications and early ambulation.[10] It includes ambulation, incentive spirometry, continuous positive airway pressure (CPAP), positive expiratory pressure (PEP) and conventional physiotherapy including deep breathing exercises, strengthening of abdominal muscle, core muscle strengthening. Breathing exercises involve breathing patterns that can be combined with upper limb and trunk movements, as well as thoracic cage maneuvers which improves breathing pattern and increase lung expansion, respiratory muscle strength, functional residual capacity, and inspiratory reserve volume [10,11]. Exercises improve muscle tone and increases blood flow to the area, facilitating healing. There are several abdominal exercises that can perform post-surgery to restore strength and balance to abdomen. The muscles of the abdomen weaken because the incision goes through muscle and fascia, which is connective tissue. So failing to exercise may cause a hernia. This will also negatively affect your posture and balance. [12] Effect of these exercises is of fundamental importance to physical therapists as this knowledge will help them to select the best interventions for patients submitted to post-operative abdominal surgeries. [10] Therapeutic exercise before and after surgery might augment the postoperative outcomes by improving functional status and reducing the complication and mortality rate. Moreover, there is circumstantial evidence suggesting post-operative exercise for thoracic, abdominal and major joint replacement surgery is effective, provided that this is offered to the high-risk patients. [13] Postoperative exercise should be initiated as soon as possible after surgery according to fast-track or enhanced recovery after surgery principles. The need of the present study will assess the effectiveness of breathing exercises and abdominal





**Anjan Desai and Hathila**

strength training program in post-operative open abdominal surgery patients. Abdominal strength measurement was the first trial and intervention with breathing exercises and abdominal strength exercises are rarely investigated following post-operative abdominal surgeries. So the pilot study was conducted to check its effectiveness along with two more variables.

**MATERIALS AND METHODS**

Ethical clearance was taken from institutional ethical committee, faculty of medicine, Parul University human research (PU-IECHR), Vadodara (Approval vide, PUIECHR/PIMSR/00/081734/2601). CTRI registration of RCT has been done from clinical trial registry; India (Reg. No.: CTRI/2020/09/027868 [Registered on: 17/09/2020]). Permission letter was taken from the place of study area/hospitals where the study was conducted. This study was the part of the Ph.D work. Sample size found for the research was more than 200. So we have taken 57 patients for pilot study recommended by Sim and Lewis. [14]The post operative abdominal surgery patients were recruited using convenient sampling between the age group of 18 to 65 years. Subjects with known neurological deficits, cardio respiratory disease and with unstable medical condition were excluded from the study. With prior informed consent of all the subject and/or relatives, all patients were divided into two groups randomly by chit picking method. The procedure of the study was explained to all the participants. All the patients were assessed for different factors thoroughly with assessment prior to inclusion in the study. All the patients were assessed for pain, abdominal muscle strength and Activities of daily living on the day one. Assessor blinding was implemented as assessor was not aware of the allotment of groups for patients. Pain was assessed using visual analogue scale [15, 16, 17, and 18]; abdominal strength was evaluated using Chattanooga pressure biofeedback[18]. Activities of daily living evaluated using the barthel index scale. [19, 20, 21]All the outcome measures were assessed on 1st day and after one month. All the patients of group A received respiratory exercises along with abdominal strength training 3 times a week for 4 weeks. All the subjects of group B received respiratory exercises 3 times a week for 4 weeks. Respiratory exercises included deep breathing exercises, huffing and coughing exercises. Abdominal strength training included pelvic tilting; knee rolling, buttocks lift and head lift exercises. All the patients were re-assessed at pre-decided intervals post-operatively using the outcomes measures.

**RESULTS AND DISCUSSION**

All statistical analyses were performed using the SPSS™ version 20.0. The subject was assessed on the baseline before treatment, and at the end of 1 month. Prior to final analysis, data were screened for transcription errors, normality assumptions, homogeneity of variance, as prerequisites for parametric calculations of the analysis of difference and analysis of related measures. The sample was not found to be distributed normally when tested using Kolmogorov-Smirnov test. The data was tested using Mann Whitney U test for intra group analysis and Wilcoxon sign rank test for inter group analysis at level of significance <0.001 for all outcomes on basis of normality distribution tested. Alpha level was set at 0.05 to control for type I error and confidence interval was set at 95% for all statistical analysis. Within group analysis for Group A and B was done for all the outcome measures. For VAS, ADL and abdominal muscle strength; Wilcoxon signed rank test was used. Within group analysis shows improvement in both the groups for all the outcome measures. P value is <0.001 for all. It proves that respiratory exercises alone as well as respiratory and abdominal strength training improve abdominal strength, ADL and also helps in reducing pain after post operative abdominal surgeries Between groups analysis shows that the results for experimental and control groups were not different statistically in terms of VAS, ADL and abdominal strength, improvement in abdominal strength group was found to be significant statistically with P value <0.001 suggesting that subjects in experimental group has improved strength in abdominal muscles as well as it was statistical significant reducing pain improving ADL as well. Various studies have been reported the post surgical complications in pulmonary and/or cardiac surgeries. (B. Dureuil et. al., Valerie A. Lawrence et. al.) [22].After surgery the quality of life hinders due to certain post operative complications. Studies also showed the better improvement in various complications in pulmonary and cardiac surgeries following pre and post physiotherapy (Sjaak Pouwels et. al., S. Souza Possa et.al.).



**Anjan Desai and Hathila**

Effectiveness of physiotherapy exercises are rarely investigated after post abdominal surgeries. Previous study by Stessel B, 2015 [23] suggested that improvement in pain following open abdominal surgery can be influenced by patients' perception of anxiety, and breathing and relaxation exercises. It helps in alleviating pain by reduction in stress and anxiety. Bozorg et al., 2018 [24] also conducted a study on pain in post-burns patients using rhythmic breathing technique and concluded that patients can be benefitted by use of breathing techniques as such intervention induce release of pain relieving substances and hormones. Our study also shows similar results. Breathing technique is effective as a non-pharmacological method to reduce pain. According to gate control theory, it can be explained this way when the input from descending and inhibitory fibers of brain was more than stimulus input of small fibers, the gate is closed and the pain data cannot be accordingly, relaxation can reduce or complete remove the pain through inhibitory impulses of the cerebral cortex and thalamus and thus closing the gate. A E Hemingway, 2018 [25] proves increase in abdominal oblique muscle strength during rehabilitation after surgical repair of abdominal wall. Our study findings support the results. Strengthening the abdominal and pelvic muscles helps reduce the risk of complications such as abdominal weakness or low back pain. Improvement in strength along with reduction in pain immediate post operative period will reduce the hospital stay as well. Previous study by Lawrence et al, 2004 [22] reported that there is maximum functional decline in terms of ADL, IADL, mental health and functional independence of patients undergoing surgery. The clinical course of functional recovery was variable and protracted disability at 6 months after operation was substantial. Improvement in activities of daily living following open abdominal surgery can be influenced by early identification and intervention which can serve as a tool to evaluate and improve the process of care and also affects post-discharge outcomes. A systematic review by Loo Michelle et al, 2021 reported positive effect of physical activity on the healing wound and Interventions designed to shorten convalescence demonstrated improvements only in patient-reported symptoms. [26] None reported an association between activity and complications, such as incisional hernia. ADL in turn is directly related to pain and strength, so if there will be improvement in ADL also. The study was pilot study, so the future study will be on actual sample size we found for the study. Age group was 18-35. Future actual study will be conducted more sample size with vast age group with other factors affecting it. More studies are recommended for abdominal strength training with different outcome measures. We have used Chattanooga pressure biofeedback to measure the abdominal strength. This device is used to measure strength and endurance both, but we have limited to measure only strength in actual study also, so future study can be recommended to measure strength as well as endurance both.

**CONCLUSION**

Present study gives an evidence for respiratory as well as abdominal strength training exercises in patients with post operative abdominal surgeries. Early exercises in immediate post operative period, exercises may add on effect on overall rehabilitation programme in post operative patients with abdominal surgeries which prevents the post operative complications, shorten the hospital stay improves the overall physical as well as mental health of the patients.

**Conflicts of interest:** none

**Financial support and sponsorship:** nil

**ACKNOWLEDGEMENTS**

I would like to sincerely thank the institute where I am pursuing my degree of PhD for exploring the area of post abdominal surgeries along with the institute I work. I express my gratitude to my guide for their guidance and also to the subjects who have participated in study. I would like to thank my family and friends throughout constant support.



**Anjan Desai and Hathila****REFERENCES**

1. Smith AK, Walter LC, Miao Y, et al. Disability during the last two years of life. *JAMA Intern Med* 2013; 173:1506–1513 [PMC free article] [PubMed]
2. Boyd CM, Landefeld CS, Counsell SR, et al. Recovery of activities of daily living in older adults after hospitalization for acute medical illness. *J Am Geriatr Soc* 2008; 56:2171–2179 [PMC free article][PubMed]
3. Tak E, Kuiper R, Chorus A, Hopman-Rock M. Prevention of onset and progression of basic ADL disability by physical activity in community dwelling older adults: a meta-analysis. *Ageing Res Rev* 2012; 12:329–338 [PubMed]
4. Debas HT, Gosselin R, McCord C, Thind A. Surgery. In: Jamison DT, Breman JG, Measham AR, et al. (2006) *Disease control priorities in developing countries*. 2nd ed. Disease Control Priorities Project. Washington, DC: International Bank for Reconstruction and Development/World Bank: pp 1245–1260.
5. GRAMS, Samantha T. et al. Breathing exercises in upper abdominal surgery: a systematic review and meta-analysis. *Rev. Bras. fisioter.* [Online]. 2012, vol.16, n.5, pp.345-353. Epub Oct 09, 2012. ISSN 1413-3555. <http://dx.doi.org/10.1590/S1413-35552012005000052>.
6. Kalpana Vinod Kelkar. *Post-operative pulmonary complications after non-cardiothoracic surgery*. *Indian J Anaesth.* 2015 Sep; 59(9): 599–605. doi: 10.4103/0019-5049.165857 PMID: PMC4613407. Van Ramshorst GH, Kleinrensink G-J, Hermans JJ, Terkivatan T, Lange JF. Abdominal wall paresis as a complication of laparoscopic surgery. *Hernia*. 2009; 13(5):539-543. Doi: 10.1007/s10029-009-0473-6.
7. Aroori S, Spence RA. Chronic pain after hernia surgery –An Informed Consent Issue. *The Ulster Medical Journal.* 2007; 76(3):136-140.
8. JENNINGS WK, RYDELL JR, ZIMMERMANN H. Postoperative Abdominal Muscle Spasm. *AMA Arch Surg.* 1957; 74(5):804–808. doi:10.1001/archsurg.1957.01280110146020.
9. Watters JM, Clancey SM, Moulton SB, Briere KM, Zhu JM. Impaired recovery of strength in older patients after major abdominal surgery. *Annals of Surgery.* 1993; 218(3):380-393.
10. Does physiotherapy reduce the incidence of postoperative complications in patients following pulmonary resection via thoracotomy? A protocol for a randomized controlled trial Julie C Reeve, Kristine Nicol, Kathy Stiller, Kathryn M McPherson and Linda Denehy. *Journal of Cardiothoracic Surgery* 2008, 3:48 doi: 10.1186/1749-8090-3-48.
11. Grams, Samantha T., Ono, Lariane M., Noronha, Marcos A., Schivinski, Camila I. S., & Paulin, Elaine. Breathing exercises in upper abdominal surgery: a systematic review and meta-analysis. *Brazilian Journal of Physical Therapy*, 16(5), 345-353. Epub October 09, 2012.
12. Exercises After Abdominal Surgery by SARKA-JONAE MILLER Last Updated: Sep 11, 2017. LIVESTRONG.COM.
13. Hoogeboom TJ, Dronkers JJ, Hulzebos EHJ, van Meeteren NLU. Merits of exercise therapy before and after major surgery. *Current Opinion in Anesthesiology.* 2014; 27(2):161-166.
14. Julius Sim, Martyn Lewis, The size of a pilot study for a clinical trial should be calculated in relation to considerations of precision and efficiency, *Journal of Clinical Epidemiology*, Volume 65, Issue 3, 2012, Pages 301-308, ISSN 0895-4356, <https://doi.org/10.1016/j.jclinepi.2011.07.011>
15. D. Gould et al. Visual Analogue Scale (VAS). *Journal of Clinical Nursing* 2001; 10:697-706.
16. Dauphin AP et al. Bias and Precision in Visual Analogue Scales: A Randomized Controlled Trial. *American Journal of Epidemiology* 1999; 150(10): 1117-1127.
17. Mc Cormack HM, Horne DJ, Sheather S. Clinical applications of visual analogue scales: a critical review. *Psychol Med* 1988; 18:1007–19.
18. Kisner, Carolyn, Lynn Allen Colby. (2013). *Therapeutic Exercise : Foundations and Techniques* (6th Edition). Philadelphia: F.A. Davis Company.
19. Collin C, Wade DT, Davies S, Horne V. The Barthel ADL Index: a reliability study. *Int Disabil Stud.* 1988; 10(2):61-63.
20. Mahoney FI, Barthel DW. Functional evaluation: the Barthel Index. *Md State Med J.* 1965; 14:61-65.





**Anjan Desai and Hathila**

21. Wade DT, Collin C. The Barthel ADL Index: a standard measure of physical disability? Int Disabil Stud. 1988; 10(2):64-67.
22. Lawrence VA, Hazuda HP, Cornell JE, Pederson T, Bradshaw PT, Mulrow CD, Page CP. Functional independence after major abdominal surgery in the elderly. Journal of the American College of Surgeons. 2004 Nov 1; 199(5):762-72.
23. Stessel B, Fiddelers AA, Joosten EA, Hoofwijk DMN, Gramke HF, Buhre WFFA. Prevalence and Predictors of Quality of Recovery at Home After Day Surgery. Medicine (Baltimore). 2015 Sep; 94(39):e1553. doi: 10.1097/MD.0000000000001553. PMID: 26426622; PMCID: PMC4616829.
24. Bozorg-Nejad M, Azizkhani H, Mohaddes Ardebili F, Mousavi SK, Manafi F, Hosseini AF. The Effect of Rhythmic Breathing on Pain of Dressing Change in Patients with Burns Referred to Ayatollah Mousavi Hospital. World J Plast Surg. 2018 Jan;7(1):51-57. PMID: 29651392; PMCID: PMC5890366.
25. Hemingway AE, Herrington L, Blower AL. Changes in muscle strength and pain in response to surgical repair of posterior abdominal wall disruption followed by rehabilitation British Journal of Sports Medicine 2003;37:54-58.
26. Loor MM, Shah P, Olavarria OA, Dhanani N, Franz MG, Trautner BW, Liang MK. Postoperative Work and Activity Restrictions After Abdominal Surgery: A Systematic Review. Annals of Surgery. 2021 Aug 1; 274(2):290-7.

**Table 1: Descriptive statistics of the sample (n=57)**

Demographic Distribution of subjects in both groups				
Characteristics	Group A [N=25]		Group B [N=32]	
	n	%	n	%
Age (years) 18-35	25	43.9	32	56.1
Male	09	36.00	17	53.1
Female	16	64.00	15	46.9
Mean ± SD	39.16±11.78		58.46±2.06	

t' test for Baseline comparisons between the group

**Table 2: Baseline comparison of mean & standard deviation between group A and B.**

Baseline Comparison between Group A and Group B			
Outcome measures	Group A [N=25]	Group B [N=32]	P – value
	Mean ± SD	Mean ± SD	
VAS-BASE	5.20±1.29	5.53± 1.54	0.010
STRENGTH-BASE	3.32±1.37	3.31±1.17	0.000
ADL-BASE	30.80±5.09	26.75±6.06	0.000
α level 0.05 at 95% CI			

**Table 3: The within Group Comparison of Result of Groups**

Within Group Comparison Result of Groups				
Variables	Pre treatment	Post treatment	Z value	P value
VAS	5.20	1.54	6.61	0.000
Abdominal strength	3.32	9.01	6.71	0.000
ADL	30.80	87.57	6.57	0.000
α level 0.05 at 95% CI				

**Table 4: Between Group Comparison of Result of Groups**

Between Group Comparison of Result of Groups		
Outcome Measure	Z value	P value
VAS	6.618	0.000
STRENGTH	6.717	0.000
ADL	6.578	0.00
α level 0.05 at 95% CI		





## A Comprehensive Analysis of Predicting Individual Cricket Players' Performance: A Survey

M. Chandru<sup>1</sup> and B. Jayanthi<sup>2</sup>

<sup>1</sup>Ph.D. Research Scholar, Department of Computer Science, Kongu Arts and Science College (Autonomous), Erode, Tamil Nadu, India.

<sup>2</sup>Associate Professor, Department of Computer Science, Kongu Arts and Science College (Autonomous) Erode, Tamil Nadu, India.

Received: 03 Nov 2021

Revised: 17 Dec 2021

Accepted: 13 Jan 2022

### \*Address for Correspondence

#### M. Chandru

Ph.D. Research Scholar,  
Department of Computer Science,  
Kongu Arts and Science College (Autonomous),  
Erode, Tamil Nadu, India



This is an Open Access Journal / article distributed under the terms of the **Creative Commons Attribution License** (CC BY-NC-ND 3.0) which permits unrestricted use, distribution, and reproduction in any medium, provided the original work is properly cited. All rights reserved.

### ABSTRACT

The growth of automated machine learning by guessing and forecasting is significant in cricket. Player selection is one of the essential jobs in any sport, and cricket is no exception. The players' performance is influenced by a variety of variables such as the opposing team, the venue, his present form, and so on. The team management, coach, and captain choose eleven players from 15 to 20 players from a roster. Because cricket is so highly respected and popular, no one can predict who will win until the game's last over-the-top ball. And many variables, including individual performance, team performance, and environmental conditions, must be considered while developing a game strategy. As a result, we decided to create a machine learning model to forecast the outcome of its games; in this Survey, a thorough study of predicting player performance and score prediction is provided. According to the study's findings, the player's handedness (batsman) and the team's rank have a substantial impact on player performance.

**Keywords:** Cricket, Player, Performance, ODI, T20

## INTRODUCTION

Cricket is the most popular sport. The game first appears in the fifteenth century in England. Today, cricket is more than just a game in India; it is a religion. With more and more fans across the globe, cricket may soon surpass football as the most popular sport in the world. There are three types of formats [1]. An ODI match consists of 50 overs that are played in a single day. The second format is the test format, which is the original format of the game [2]. It is played in 5 days, and consists of two innings from each side, with an average of 80 to 90 innings played each day. The squad must continuously perform for 5 days. This is an extremely difficult game type in which a player's

38272



**Chandru and Jayanthi**

endurance, strength, patience, and mental fortitude are crucial. The t20 format is the third and most recent version of cricket [3]. This version was established in 2006, and India won its first world cup in 2007. It is a quick game with 20 levels that takes less than 3 hours to complete. It is made up of two teams, each of which has 20 over to play. Because of the IPL, the t20 format is extremely popular in India. This competition is largely responsible for the development of the t20 format in India [4]. This system created will have two models. The first model forecasts a team's score after playing 50 overs from the present scenario. The second approach forecasts the victory % of both sides even before the match begins, which is accomplished via player selection [5]. The primary aim is to combine previous match's data and in-diversion data with the ultimate goal of assembling the simplest discriminating model. These factors are used while defining the nice discerning model: several wickets fallen, match setting, placement of the batting cluster, hurl, and home group advantage [6]. As no such analysis has enhanced true this cricket organization, this may be selected to need the look at as cricket contests are especially notable these days [7]. However, in India's IPL, a team was formed from an existing group of players via a player auction for the first time. The results of these matches are critical for the stakeholders due to the large fan base, team passion, and financial investment [8]. The game's regulations determine the toss winner, which is determined by the team's luck, the players' competency, and their performance on game day. Many contextual variables, such as previous performance data from players, play a significant role in predicting the result of a cricket match. A method that predicts the result of a match between various teams may help in team selection. However, the numerous factors involved make forecasting the precise result of the match very challenging [9]. Furthermore, the forecast's accuracy is dependent on the quantity of the data. For this Survey, we processed and made suggestions based on different author data. Improved models can assist decision-makers during cricket games by testing a team's capabilities against other teams and environmental variables [10]. Based on data collection, we want to contribute to the planned project in the areas listed below,

- Provide analysis of player statistics based on various factors.
- Predict team performance based on individual player statistics.
- Predict Successful prediction of cricket results.
- Predict predictably predict environmental factors affecting the cricket league.

In every sport, selecting the best players for a certain match entails forecasting the players' performance. Player selection is essential in cricket since the 11 players chosen at the start of the match are set until an injury occurs. Furthermore, replacement players in such situations have restricted rights [11]. The performance of players may be predicted by examining their previous data and attributes. Cricket players' skills and performance may be assessed using several metrics. Batting statistics include batting average, strike rate, number of centuries, and so on.

**Background Study**

A.N.Wickrama singhe and Roshan D.Yapa [2] used R-Studio to develop Cricket Match Outcome Prediction using Twitter API network analysis. According to the paper's logistic models, the combination of degree and between centrality measures has the greatest accuracy (92%). In a one-day cricket match, Barr et al [4]. suggested comparing and choosing batsman. The authors solely consider batting average and strike rate when choosing a batsman. However, the kind of wicket and the weather have a significant impact on player performance. Bhattacharjee et al [5]. analyze to forecast bowler performance in 2012. Some essential factors, such as bowling speed, are overlooked by the authors, even though they significantly influence a player's success. This study's only purpose is to forecast bowler performance. Iyer and Sharda [6] divide bowlers and batters into three groups: performers, failures, and moderates. The authors used a neural network-based method to predict player performance. They used this method to choose the World Cup 2007 squad-based on individual performance ratings. In 2017, Hasseb Ahmed et al [7]. projected emerging cricket stars. They utilized various machine learning and statistical methods to identify the top 10 emerging cricketers based on performance development and weighted average. Finally, they matched growing star scores to the ranks of the International Cricket Council Pranavan Somaskandhan et al [8]. seek to find the optimum collection of characteristics that strongly affect the outcome of a cricket match. Statistical analysis and Machine Learning are used in the suggested approach. Various Machine Learning methods were used, with the Support Vector Machine (SVM) achieving the highest accuracy in the assessment. Prince Kansal et al [9]. developed



**Chandru and Jayanthi**

various prediction models for forecasting a player's selection in the IPL based on each player's previous performance. To achieve the goal, several Data Mining methods such as Decision Tree, Nave Bayes, and Multilayer Perception (MLP) are used in the dataset. MLP outperformed all other algorithms in terms of accuracy. Shimona S et al [11]. desire to evaluate IPL cricket match outcomes from a dataset gathered using the current Data Mining method to balance unbalanced datasets. The model was constructed successfully, with a 97 percent accuracy rate for the balanced dataset. The error rate in the unbalanced dataset was found to be higher than in the balanced dataset.

**Performance Analysis****Processing of datasets**

This module aims to get the IPL data ready and properly formatted with the appropriate data type for the project's function. We are utilizing a dataset in yaml (a kind of xml format) acquired from a cricsheet website (containing complete ball by ball detail). It takes each match's yaml data file, analyses it, and stores match-by-match full ball-by-ball information in a native R data frame with the appropriate data types given. Because using a native R data frame will make subsequent data reading and processing considerably quicker and more efficient. Following that, it extracts and produces a new data frame from each match-wise data frame, which contains the complete batter related (team-wise), bowler related (team-wise), inter-team related, and a specific team's entire career information. This module is the project's beating heart. For the remainder of the modules to function correctly, all data frames must be produced and put in the appropriate locations.

**Batsmen performance analysis**

This module enables the analyst to do a thorough study of a batsman profile. Initially, it collects information from all of the IPL teams for whom a certain batsman has played (as it is highly probable for the player to have played for more than one team). After creating the full batsman profile, it may next conduct a broad range of analyses and visualizations. A subset of them contains features such as charting a batsman's scores against deliveries played by him, analyzing the different ways he was out, analyzing his batting average and strike rates, runs scored by him, venue-wise, and so on.

**Bowler performance analysis**

This module enables the analyst to do a thorough study of a bowler profile. Initially, it collects information from all of the IPL teams for whom a certain bowler has played (as it is highly probable for the player to have played for more than one team). After creating the full bowler profile, it may next conduct a broad range of analyses and visualizations. A subset of them contains features like the bowler's mean economy rate, average runs were given, his wicket type plot, how well they have done against certain opposition, how well he has performed at a specific location, and so on.

**Match analysis's objective**

This module is responsible for thoroughly analyzing a single match. Aside from the fundamental functionality of viewing a match's batting and bowling scorecard, it also includes sophisticated analytical and visualization features. A subset of these includes analysis of each team's greatest batting partnership in that match, how well certain batsman fared against a specific bowler and vice versa, a few batsman and bowler specific functions and vice versa, the match worm graph of two sides to observe how they played, and so on.

**Head on head analysis of teams**

This module compares and contrasts just two teams by evaluating all previous matches they played against each other. This feature would significantly aid decision-making for both sides anytime they faced off against one other. It also has a broad range of functions. A subset contained the greatest batting partnerships per team when they played in the past, comprehensive batting and bowling scorecards, how well certain batters had fared against specific bowlers when those two teams played, win-loss analyses, and so on.





### Chandru and Jayanthi

#### Team overall performance analysis

This module is used to evaluate a team's overall performance. It thoroughly analyzes all the matches played by a certain team throughout its history by using a broad range of features. This feature would be a major determining element when assessing a team's overall standards and selecting favorites. A subset of these includes the team's greatest batting partnerships in its history, the team's overall batting and bowling scorecard, the team's best batsman against the tournament's best bowlers, the team's best bowlers versus the tournament's top batters, and so on. In terms of rating, batters and bowlers may choose between three ways of ranking. The simplest and most basic method is to use batting average. The second is done using Rediff's MVPI (most valuable player index) ranking score. Rediff Sports suggested this to provide valuable information on athletes. For the third kind of ranking, we create the PRI of batters and bowlers and rank them using the criteria given below for batsman and bowlers. More information regarding all of the rank generating will be included in subsequent parts.

For batsman, they are:

1. Hard-hitter
2. Finisher
3. Fast-scorer
4. Consistent
5. Running-between-wickets

For bowlers, they are

1. Economy
2. Wicket-taker
3. Consistent
4. Big-wicket-taker
5. Short-performance-index

A crucial element now is anticipating which of the two competing teams will win a match. As stated in earlier sections, the likelihood value has a significant effect on several things. Players in the IPL aren't always assigned to a single team since they are auctioned off at the end of each season. The only thing that stays with a player is his performance, how well he performed in prior seasons, regardless of whatever club he was on. We utilize PRI and conduct the calculation based on this specific characteristic. More information regarding the match prediction will be provided in subsequent parts. For each module, we've developed a user interface. It's an interactive, sparkling online app with a front end and back end built entirely in R. It performs all of the functions described in the preceding modules. It has three input fields. The module to be examined comes first, followed by the specific functionality to be studied, and finally, the specific player to be analyzed. The calculation is carried out in the backend. In the front end, the result is presented in the form of a graph or a table.

#### Cricket Player Ranking Index

##### Batting average ranking

Here, the batsman is ranked in descending order according to their batting average.

$$BA = (TR/TM)$$

TR is the total runs scored by the batsman

TM is the total matches played by the batsman.

##### Batman MVPI ranking

This is a better ranking model than batting average, which considers both batting average and batting strike rates, respectively. So, we get a better measure of ranking for limited over IPL-T20 cricket.

$$MVPI = ((MR/TMR) + (MSR/TMSR)) * TR$$

Where

MR is the batting average of a particular batsman

TMR is the average of all batsman in the IPL







### Chandru and Jayanthi

MSR is the mean strike rate of a particular batsman

TMSR is the mean strike rate of the entire batsman in the IPL

TR is the total runs of the batsman

#### Batsman PRI (Player ranking index)

This is the best ranking model or an improvement on the MVPI ranking. It considers five distinct criteria. In T20 cricket, everything counts the most. When it comes to the batsman, criteria such as how hard he can smash the ball (excellent at hitting 4s and 6s), remaining not out, not wasting any deliveries, consistent performance. Lastly, his running between the wickets is taken into account. We train a random forest model with predictors as these measurements and the result being MVPI, then we produce the PRI score and rank the batsman using all of these metrics.

The PRI is found using five parameters for a batsman. The parameters for batsman include:

Hard-Hitter =  $((4 * \text{Four} + 6 * \text{Six}) / \text{Balls played by batsman})$

Finisher =  $(\text{Count of matches being not out} / \text{Total Count of innings played})$

Fast-Scorer =  $(\text{Player batting strike rate})$

Consistent =  $(\text{Player batting average})$

Running-Between-Wickets (RBW) =  $((\text{Run scored by the player}) - (4 * \text{Fours} + 6 * \text{Sixes}) / \text{Number of balls faced without boundary})$

#### Bowling average ranking

Here, the bowlers are ranked in descending order according to their bowling average.

BOA =  $(\text{TW} / \text{TM})$

TW is the total wickets taken by a bowler

TM is the total matches played by a bowler

#### Bowling MVPI ranking

This is a better model of ranking than bowling average, which considers both bowling average and bowling economy rate, respectively. So, we get a better measure of ranking for limited over IPL-T20 cricket.

MVPI =  $((\text{MW} / \text{TMW}) + (\text{TMER} / \text{MER})) * \text{TW}$

where

MW is the mean wickets taken by the bowler— TMW is the mean wickets taken by all the bowlers in the tournament

TIMER is the mean economy rate of all the bowlers in the tournament

MER is the average economy rate of the bowler

TW is the total wickets taken by the bowler.

#### Bowling PRI (Player ranking index)

This is the best ranking methodology or an improvement above the MVPI ranking. It considers five distinct criteria. In T20 cricket, everything counts the most. Bowlers are evaluated using economy, wicket-taker, consistency, large wicket-taker, and short performance. We train a random forest model with predictors as these measurements and the result being MVPI, and then we produce the PRI score and rank the batsman using all of these metrics. For bowlers, the PRI is calculated using five factors. Bowlers' parameters include the following:

Economy =  $(\text{Runs conceded by player} / (\text{Count of balls bowled} / 6))$

Wicket-Taker =  $(\text{Count of balls bowled} / \text{Count of wickets taken})$

Consistent =  $(\text{Runs conceded by the bowler} / \text{Count of wickets taken})$

Big-Wicket-Taker =  $(\text{Count of four wickets or five wickets or six wickets taken} / \text{Count of innings played})$

Short-Performance =  $((\text{Count of total wickets} - 4 * \text{Count of four-wicket haul} - 5 * \text{Count of times five-wicket haul} - 6 * \text{Count of six-wicket haul}) / (\text{Count of total played innings} / \text{Count of times four (or) five (or) six-wicket hauls totally}))$



**Chandru and Jayanthi**

## CONCLUSION

In this Survey, an intelligent system for predicting players' performance in one-day international cricket matches must include factors other than batting and bowling. The weather is an important element to consider since it has a significant effect on player performance. This analysis may be improved by taking into account other variables such as the batter and bowler. Previous match outcomes that came from super over must also be independently evaluated and incorporated in the model. These dynamic variables have the potential to alter the result of a match in a matter of seconds.

## REFERENCES

1. Anik, A. I., Yeaser, S., Hossain, A. G. M. I., & Chakrabarty, A. (2018). Player's Performance Prediction in ODI Cricket Using Machine Learning Algorithms. 2018 4th International Conference on Electrical Engineering and Information & Communication Technology (ICEEICT). doi:10.1109/ceeict.2018.8628118
2. A.N.Wickramasinghe, Roshan D.Yapa, "Cricket Match Outcome Prediction Using Tweets and Prediction of the Man of the Match using Social Network Analysis: Case Study Using IPL Data," 2018.
3. Bunker, R. P., & Thabtah, F. (2017). A machine learning framework for sport result prediction. Applied Computing and Informatics. doi:10.1016/j.aci.2017.09.005
4. G. D. I. Barr and B. S. Kantor, "A criterion for comparing and selecting batsmen in limited overs cricket", J. Oper. Res. Soc., vol. 55, no. 12, pp. 1266–1274, 2004.
5. D. Bhattacharjee and D. G. Pahinkar, "Analysis of Performance of Bowlers using Combined Bowling Rate", Int. J. Sport. Sci. Eng., vol. 06, no. 03, pp. 184–192, 2012.
6. S. R. Iyer and R. Sharda, "Prediction of athletes performance using neural networks: An application in cricket team selection", Expert Syst. Appl., vol. 36, no. 3 PART 1, pp. 5510–5522, 2009.
7. H. Ahmad, A. Daud, L. Wang, H. Hong, H. Dawood, and Y. Yang, "Prediction of Rising Stars in the Game of Cricket", IEEE Access, vol. 5, pp. 4104–4124, 2017.
8. Pranavan Somaskandhan, Gihan Wijesinghe, Leshan Bashitha Wijegunawardana, Asitha Bandaranayake and Sampath Deegalla, "Identifying the Optimal Set of Attributes that Imposes High Impact on the End Results of a Cricket Match using Machine Learning", IEEE, 2017.
9. Prince Kansal, Pankaj Kumar, Himanshu Arya and Aditya Methaila, "Player Valuation in Indian Premier League Auction using Data Mining Technique", IEEE, 2014.
10. Singh, T., Singla, V., & Bhatia, P. (2015). Score and winning prediction in cricket through data mining. 2015 International Conference on Soft Computing Techniques and Implementations (ICSCTI). doi:10.1109/icscti.2015.7489605
11. Shimona S, Nivetha S and Yuvarani P, "Analzing IPL Match Results using Data Mining Algorithms", International Journal of Scientific and Engineering Research, Volume 9, Issue 3, March – 2018.





## Halophiles- A Short Review

Parveen. A\* and Devika. R

<sup>1</sup>Research Scholar, Department of Biotechnology, Aarupadai Veedu Institute of Technology, Paiyanoor, Chennai, India

<sup>2</sup>Professor and Head, Department of Biotechnology, Aarupadai Veedu Institute of Technology, Paiyanoor, Chennai, India

Received: 10 Nov 2021

Revised: 15 Dec 2021

Accepted: 19 Jan 2022

### \*Address for Correspondence

#### Parveen. A

Research Scholar,  
Department of Biotechnology,  
Aarupadai Veedu Institute of Technology,  
Paiyanoor, Chennai, India.



This is an Open Access Journal / article distributed under the terms of the **Creative Commons Attribution License** (CC BY-NC-ND 3.0) which permits unrestricted use, distribution, and reproduction in any medium, provided the original work is properly cited. All rights reserved.

### ABSTRACT

In concentrated salt solutions, such as salt lakes or soda lakes, coastal lagoons, or artificial salt flats, prokaryotic bacteria predominate, with only a few higher life kinds present. Global salt deposition shows that salty sea water evaporation and the development of high-salinity ecosystems have occurred for millions of years, offering numerous possibilities for halophilic bacteria and unique archaea to evolve. To develop optimally, halophilic bacteria require more than 0.5 M NaCl. To deal with high ionic strength and high-water stress, they created two basic osmotic adjustment solute accumulation methods. Halophiles can thrive in saturated environments because of these mechanisms.

**Keywords:** ecosystems, halophilic, bacteria, prokaryotic.

## INTRODUCTION

Halophiles are organisms such as archaea, bacteria, and eukarya that have a salinity requirement, making them halophilic or "salt-loving." Natural microbial communities in hypersaline habitats are made up of halophilic bacteria, which are found all over the planet. Because of their inherent unlikeliness, organisms capable of growing in, or demanding, high or saturated salt concentrations pique the biologist's interest (1). Microbes from the domains Archaea and Bacteria have been recovered from these severe habitats, where they play a role in overall organic matter oxidation (2). Many halophilic bacteria have been found in a variety of habitats, including artificial solar salterns, natural brines in coastal and undersea pools, and deep salt mines. Halophiles such as *Halobacterium* spp. (a misnomer because they are members of the domain Archaea), *Salinibacter ruber* (a member of the *Bacteroidetes* phylum), and *Dunaliella salina* flourish in salterns used for salt manufacture (green alga of the *Chlorophyceae* class) (3). Moderate and extreme halophiles have been identified from alkaline environments as well as hypersaline environments (salt lakes, marine salterns, and saline soils) (alkaline lakes). The Great Salt Lake (Utah, USA), the



**Parveen and Devika**

Dead Sea (Israel), the alkaline brines of Wadi Natrun (Egypt), and Lake Magadi among the most researched ecosystems (Kenya)(4). It's worth noting that all of these saline settings have limited taxonomic biodiversity, which is most likely due to the high salt concentrations found there(5,6). Halophilic microbes have long been known to cause deterioration in solar-salted fish and meat, and some types have been employed in the fermentation of protein-rich diets. Adaptation of halophilic bacteria has occurred throughout the last few decades. The application of culturing, manipulation, and genetic engineering techniques to their environment has piqued attention, with methodology for culturing, manipulation, and genetic engineering rapidly improving. Several alternative methods for balancing halophile adaption to high salinity have been discovered(7). Halophiles may thrive and survive in situations where most other species would perish. *Halophilic archaea* make up a huge percentage of the prokaryotic world in both marine and terrestrial ecosystems, implying that creatures from this domain could have a significant impact on global energy cycles. Their unique features make them a potentially useful resource for developing new biotechnological processes and industrial uses. The *Halophilic archaea* have now been identified as a category of ancient organisms that arose under primordial earth conditions such as high salinity(8). The extremely *Halophilic archaea*, in particular, are well adapted to saturating NaCl concentrations and have a number of novel molecular characteristics, including enzymes that function in saturated salts, a purple membrane that allows phototrophic growth, sensory rhodopsins that mediate the phototactic response, and gas vesicles that aid cell flotation(9). Halophiles are currently being explored extensively due to their numerous applications that have just been identified.

**Characteristic features of Halophiles**

are organisms such as archaea, bacteria, and eukarya that have a salinity requirement, making them halophilic or "salt-loving." Natural microbial communities in hypersaline habitats are made up of halophilic bacteria, which are found all over the planet. Because of their inherent unlikeliness, organisms capable of growing in, or demanding, high or saturated salt concentrations pique the biologist's interest (1). Microbes from the domains Archaea and Bacteria have been recovered from these severe habitats, where they play a role in overall organic matter oxidation(2). Many halophilic bacteria have been found in a variety of habitats, including artificial solar salterns, natural brines in coastal and undersea pools, and deep salt mines. Halophiles such as *Halobacterium spp.* (a misnomer because they are members of the domain Archaea), *Salinibacter ruber* (a member of the *Bacteroidetes* phylum), and *Dunaliella salina* flourish in salterns used for salt manufacture (green alga of the *Chlorophyceae* class) (3). Moderate and extreme halophiles have been identified from alkaline environments as well as hypersaline environments (salt lakes, marine salterns, and saline soils) (alkaline lakes). The Great Salt Lake (Utah, USA), the Dead Sea (Israel), the alkaline brines of Wadi Natrun (Egypt), and Lake Magadi among the most researched ecosystems (Kenya)(4). It's worth noting that all of these saline settings have limited taxonomic biodiversity, which is most likely due to the high salt concentrations found there(5,6). Halophilic microbes have long been known to cause deterioration in solar-salted fish and meat, and some types have been employed in the fermentation of protein-rich diets. Adaptation of halophilic bacteria has occurred throughout the last few decades. The application of culturing, manipulation, and genetic engineering techniques to their environment has piqued attention, with methodology for culturing, manipulation, and genetic engineering rapidly improving. Several alternative methods for balancing halophile adaption to high salinity have been discovered(7). Halophiles may thrive and survive in situations where most other species would perish. *Halophilic archaea* make up a huge percentage of the prokaryotic world in both marine and terrestrial ecosystems, implying that creatures from this domain could have a significant impact on global energy cycles. Their unique features make them a potentially useful resource for developing new biotechnological processes and industrial uses. The *Halophilic archaea* have now been identified as a category of ancient organisms that arose under primordial earth conditions such as high salinity(8). The extremely *Halophilic archaea*, in particular, are well adapted to saturating NaCl concentrations and have a number of novel molecular characteristics, including enzymes that function in saturated salts, a purple membrane that allows phototrophic growth, sensory rhodopsins that mediate the phototactic response, and gas vesicles that aid cell flotation(9). Halophiles are currently being explored extensively due to their numerous applications that have just been identified.



**Parveen and Devika****Characteristic features of Halophiles**

When bacteria in various shapes and sizes branched out into different environmental niches as they evolved from the hypersaline primordial sea(10), microbial adaptability played a vital part in the development of Halophiles.(11). High salty salterns or lakes are a unique environment in which a variety of bacteria, particularly halotolerants, may survive under extreme salinity. Halophiles can live not only in small salt water sources like salterns and lakes, but also in enormous seas and on the ocean's benthic floors. Some of the best examples of environmental adaptability are halophilic microorganisms. With a lot of salt in the environment, these microorganisms have established metabolic conditions that let them survive. Others manufacture suitable solutes to adapt to high salt-stress circumstances and can be discovered within fluid inclusions in salt crystals(12). Fresh water has a salinity of less than 0.05 percent, brackish water has a salinity of 0.05–3 percent, saline water has a salinity of 3–5 percent, and brine has a salinity of more than 5 percent(13). At a temperature of 28–37 °C, a pH range of 7.0–8.0, and a sodium chloride concentration of 5–20 percent, halophilic bacteria multiply well. They were classified as very (15–32 percent w/v), moderately (3–15 percent w/v), or minimally (1–3 percent w/v) halophilic based on their salinity environment and amount of halotolerance. Slight halophiles like 0.3–0.8 M NaCl (Sodium chloride 1.8–4.7 percent; saltwater is 0.6 M or 3.5 percent), moderate halophiles 0.8–3.4 M (4.7–20 percent), and extreme halophiles 3.4–5.1 M (20–30 percent)(14). Microorganisms that haven't acclimated to very saline conditions will lose water, causing their cells to shrink and eventually die due to a lack of cellular structure and function. Halophiles have evolved two distinct strategies to increase the osmotic activity of their cytoplasm with the external environment in such conditions: either producing compatible organic solutes (osmoprotectants) or reaching an equilibrium state in which the overall salt concentration within cells matches that of the environment by accumulating large salt concentrations in their cytoplasm(15,16). While much has been learned about halophilic species' intracellular sodium and potassium concentrations and how they are regulated, the metabolism of anions is becoming more understood. In distinct types of halophilic bacteria, chloride has various functions in haloadaptation(17). Halophilic organisms primarily collect organic molecules such as sugars, polyols, amino acids and/or amino acid derivatives in response to osmotic stress, either through de novo synthesis or uptake of the surrounding environment. Even at high cytoplasmic concentrations, these non-ionic, highly water-soluble molecules do not disrupt metabolism, earning them the moniker "compatible solutes(18)." In the presence of molarity of salt, the complete intracellular machinery of halophilic organisms must work. Different adaptation strategies are used by halophilic proteins. When Halobacterium and other halophiles use the "salt-in" technique, their proteins have peculiar features when compared to their nonhalophilic counterparts. They frequently show a higher preference for basic amino acids (glutamate and aspartate) than acidic amino acids (glutamate and aspartate) (lysine and arginine). Furthermore, they have a low amount of hydrophobic amino acids. Such proteins are not only soluble and functional at high salt concentrations, but they also require salt molarity for activity and stability(19).

**Classification****Halophilic archaea**

Earlier studies have shown that Archae bacteria are not confined to a methanogenic phenotype. The Kingdom could well encompass phenotypic variety comparable to that found in the Eubacterial Kingdom(20). Many distinct bacterial species, both Gram-positive and Gram-negative, and in a variety of morphologies, make up the moderate halophiles. *Micrococcus halodenitrificans* and *Vibrio costicolus* have received the greatest attention. Pigments are found in only a few moderate halophiles(21). The phylum Euryarchaeota contains the *Halophilic archaea*. They are represented by the very halophilic aerobic Archaea, also known as haloarchaea, which is now classified as part of the Halobacteria class(22). The phylogenetic study of haloarchaeal species obtained by comparing their 16S rRNA gene sequences, morphological and genotypic traits, and polar lipid analyses are now used to characterise them. The ICSP-Subcommittee on Halobacteriaceae Taxonomy issued the recommended Minimal Standards for characterising new taxa within this family in 1997, a document that may be highly valuable to researchers for the right taxonomic characterization of new haloarchaea species and genera. Haloarchaea are the prokaryotes that are most adapted to high salt concentrations, and they are unable to thrive on freshwater media, where they are lysed. In media



**Parveen and Devika**

containing 20–25 percent NaCl, they can easily develop aerobically. Some species are not only halophilic, but also haloalkaliphilic, meaning they can thrive optimum at alkaline pH values. The presence of ether-linked lipids, which can be easily detected by thin-layer chromatography (TLC), is employed as a significant trait for taxonomic distinction, notably at the genus level, in Haloarchaea(23). However, several Halobacteriaceae taxa, such as Haloterrigena, currently include species with diverse polar lipid profiles, and their taxonomic status is unknown(24).

**Halophilic Bacteria**

The halophilic and halotolerant Bacteria, unlike the *Halophilic archaea*, are found in a variety of evolutionary branches (phyla). Many halophilic and halotolerant organisms are found in the domain Bacteria, and real halophiles are well-known among the phylum Bacteria. Bacteroidetes, Cyanobacteria, Proteobacteria, Firmicutes, Actinobacteria, Spirochaetes(25). The phylum Actinobacteria includes both halophilic and halotolerant actinobacteria. According to its branching position in the 16S rRNA phylogenetic tree and taxon-specific 16S rRNA signatures, this taxon is one of the major phyla in the domain Bacteria. Furthermore, conserved indels in 23S rRNA and protein sequences support actinobacteria's separation from all other bacteria(26). Halophilic and halotolerant actinobacteria have only been found in the subclass Actinobacteridae of the class Actinobacteria, and only the Actinomycetales of the subclass Actinobacteridae contains halophilic and halotolerant actinobacteria(27). A huge number of halophilic bacteria are also found in the Halomonadaceae family. Further rearrangements based on 16S rRNA similarity and phylogenetic investigations in the genus Halomonas were carried out, and a number of taxa were reclassified inside the genus Chromohalobacter. In this family, two phylogenetic groups have been identified. *Halomonas aquamarina*, *Halomonas magadiensis*, *Halomonas variabilis*, *Halomonas meridiana*, *Halomonas venusta*, *Halomonas halodurans*, and *Halomonas subglaciescola* were classified in group 1, and *Halomonas halmophila*, *Halomonas halophila*, *Halomonas eurihalina*, and *Halomona*(28). More research has been done using protein-encoding genes to do multilocus sequence analysis (MLSA) to compare members of the Halomonadaceae family. According to an MLSA analysis of the species connections in the Halomonadaceae family, heterogeneity in the genus Halomonas may lead to the division of the genus Halomonas into two or more genera, although chemotaxonomic and phenotypic traits did not support this split.

**Applications of Halophiles**

Halophilic microorganisms have found comparatively few biotechnological applications compared to thermophilic and alkaliphilic extremophiles. Halophiles are involved in centuries-old processes such as the manufacture of traditional fermented foods and the production of solar salt from saltwater. *Dunaliella sp.*, a halophilic microalga, has been used as a promising feedstock for bioethanol synthesis. Under salt stress, one of the most critical elements is salinity, and microalgae cells are oriented toward energy storage, specifically lipid synthesis, rather as active development(29). Halophiles and their negatively charged enzymes are expected to be put to good use and become more valuable in the future. Halophiles produce extremely stable enzymes that work even when conventional enzymes fail to function, denature, and precipitate. A slew of new research have shed light on how halophilic enzymes manage to bind water tightly and sustain solvation and solubility in situations of severe salinity and low water activity(30). As a result, their research as biocatalysts in the presence of new nanomaterials is intriguing.

Enzymes, halocins (halobacterial proteins with antibiotic activity), exopolysaccharides, and other biomolecules produced by these halophilic organisms demonstrate biological activity in harsh environments. When these biomolecules are combined with diverse nanomaterials such as thin layers, nanotubes, and nanospheres, new compounds emerge that have both biological and physio-chemical properties of nanomaterials(31). Other enzymes cannot catalyse several metabolic processes, whereas halophilic enzymes can. Several halophile enzymes may be active in the presence of high salt concentrations or other severe circumstances, making them suitable for industrial applications. It may be possible to find halophiles that have both cellulase and phenol elimination activity in order to reduce COD levels and pollution in the environment. Furthermore, halophilic bacteria have an essential role in the production of biohydrogen and biogas due to their unique capacities(32). Through cell line research, anti-cancer compounds have been identified from halophilic microorganisms, focusing on the primary screening of the most common cancer forms that affect the worldwide population. Sarcoma and glioblastoma, for example, are



**Parveen and Devika**

characterised by aggressive overproliferation and have intrinsic chemoresistance(33). Halophilic microorganisms are now well understood as producers of polyhydroxyalkanoates (PHA), ectoines, halophilic hydrolases, biosurfactants / bioemulsifiers and several other chemicals. Halophiles are strong candidates for unsterile and continuous bioprocessing using seawater and mixed substrates as substrates.

**CONCLUSION**

Halophiles are a fascinating group of extremophilic species that have evolved to survive in harsh, hypersaline environments. They can successfully compete for water and withstand the denaturing effects of salts. From an evolutionary standpoint, adaptation to hypersaline circumstances is fascinating. Ancient prokaryotic fossils found in ancient stromatolites dating back over 3.5 billion years seem strikingly similar to microbial mats found in present hypersaline ponds. Biotechnology will almost certainly benefit from the discovery of halophiles. Hypersaline settings are becoming more common as a result of natural and man-made global changes. Furthermore, hypersaline settings can be easily formed by concentrating sea water in arid areas, both of which are abundant. These findings, along with the discovery of unique and stable biomolecules in halophiles, indicate that these organisms will become even more valuable in the future.

**REFERENCES**

1. Oren A. Microbial life at high salt concentrations: Phylogenetic and metabolic diversity. *Saline Systems* [Internet]. 2008 Apr 15 [cited 2021 Jun 10];4(1):1–13. Available from: <https://link.springer.com/articles/10.1186/1746-1448-4-2>
2. Mouné S, Caumette P, Matheron R, Willison JC. Molecular sequence analysis of prokaryotic diversity in the anoxic sediments underlying cyanobacterial mats of two hypersaline ponds in Mediterranean salterns. *FEMS Microbiol Ecol* [Internet]. 2003 May 1 [cited 2021 Jun 10];44(1):117–30. Available from: <https://academic.oup.com/femsec/article/44/1/117/502685>
3. DasSarma S, DasSarma P. Halophiles. In: eLS. John Wiley & Sons, Ltd; 2017. p. 1–13.
4. Post FJ. The microbial ecology of the Great Salt Lake. *Microb Ecol* [Internet]. 1977 Jun [cited 2021 Jun 10];3(2):143–65. Available from: <https://link.springer.com/article/10.1007/BF02010403>
5. Kamekura M. Diversity of extremely halophilic bacteria [Internet]. Vol. 2, *Extremophiles*. Springer; 1998 [cited 2021 Jun 10]. p. 289–95. Available from: <https://link.springer.com/article/10.1007/s007920050071>
6. Oren A. The ecology of the extremely *Halophilic archaea*. *FEMS Microbiol Rev* [Internet]. 1994 Apr 1 [cited 2021 Jun 10];13(4):415–39. Available from: <https://academic.oup.com/femsre/article/13/4/415/524297>
7. Lanyi JK. Salt dependent properties of proteins from extremely halophilic bacteria. *Bacteriol Rev* [Internet]. 1974 [cited 2021 Jun 10];38(3):272–90. Available from: <https://www.ncbi.nlm.nih.gov/pmc/articles/PMC413857/>
8. Kates M. Archaeobacterial lipids: structure, biosynthesis and function. [Internet]. Vol. 58, *Biochemical Society symposium*. 1992 [cited 2021 Jun 10]. p. 51–72. Available from: <https://europepmc.org/article/med/1445410>
9. Tiquia-Arashiro S, Rodrigues D. Halophiles in Nanotechnology. In: *Extremophiles: Applications in Nanotechnology*. Springer International Publishing; 2016. p. 53–88.
10. Dundas I. Was the environment for primordial life hypersaline? [Internet]. Vol. 2, *Extremophiles*. Springer; 1998 [cited 2021 Jun 11]. p. 375–7. Available from: <https://link.springer.com/article/10.1007/s007920050081>
11. Rajendran N. Environmental diversity and biological survivability of halophilic bacteria. In: *Halophiles: Biodiversity and Sustainable Exploitation* [Internet]. Springer International Publishing; 2015 [cited 2021 Jun 11]. p. 173–88. Available from: [https://link.springer.com/chapter/10.1007/978-3-319-14595-2\\_6](https://link.springer.com/chapter/10.1007/978-3-319-14595-2_6)
12. NORTON CF, GRANT WD. Survival of Halobacteria Within Fluid Inclusions in Salt Crystals. *Microbiology* [Internet]. 1988 May 1 [cited 2021 Jun 11];134(5):1365–73. Available from: <https://www.microbiologyresearch.org/content/journal/micro/10.1099/00221287-134-5-1365>
13. Anati DA. The salinity of hypersaline brines: Concepts and misconceptions. *Int J Salt Lake Res* [Internet]. 1999 [cited 2021 Jun 11];8(1):55–70. Available from: <https://link.springer.com/article/10.1023/A:1009059827435>
14. Oren A. Life at high salt concentrations, intracellular KCl concentrations, and acidic proteomes. Vol. 4, *Frontiers*





**Parveen and Devika**

- in Microbiology. Frontiers Media SA; 2013. p. 315.
15. Eisenberg H. Life in unusual environments: Progress in understanding the structure and function of enzymes from extreme halophilic bacteria. Arch Biochem Biophys. 1995 Apr 1;318(1):1–5.
  16. Mongodin EF, Nelson KE, Daugherty S, DeBoy RT, Wister J, Khouri H, et al. The genome of *Salinibacter ruber*: Convergence and gene exchange among hyperhalophilic bacteria and archaea. Proc Natl Acad Sci U S A [Internet]. 2005 Dec 13 [cited 2021 Jun 11];102(50):18147–52. Available from: [www.pnas.org/cgi/doi/10.1073/pnas.0509073102](http://www.pnas.org/cgi/doi/10.1073/pnas.0509073102)
  17. Müller V, Oren A. Metabolism of chloride in halophilic prokaryotes [Internet]. Vol. 7, Extremophiles. Springer; 2003 [cited 2021 Jun 15]. p. 261–6. Available from: <https://link.springer.com/article/10.1007/s00792-003-0332-9>
  18. Brown AD. Microbial water stress. Bacteriol Rev [Internet]. 1976 [cited 2021 Jun 15];40(4):803–46. Available from: <https://www.ncbi.nlm.nih.gov/pmc/articles/PMC413986/>
  19. Kanekar PP, Kanekar SP, Kelkar AS, Dhakephalkar PK. Halophiles - Taxonomy, diversity, physiology and applications. In: Springer 4. TUT Press; 2012. p. 1–34.
  20. Magrum LJ, Luehrsén KR, Woese CR. Are extreme halophiles actually “bacteria”? J Mol Evol. 1978 Mar;11(1):1–8.
  21. Bacteria H. Speculations on Moderate Halophiles ..... 1967;73–99.
  22. GRANT, D. W. Class III. Halobacteria class nov. Bergey’s Man Syst Bacteriol [Internet]. 2001 [cited 2021 Jun 22];1:294–301. Available from: <https://ci.nii.ac.jp/naid/10020540275>
  23. Ventosa A, Márquez MC, Sánchez-Porro C, Haba RRD La. Taxonomy of *Halophilic archaea* and bacteria. In: Advances in Understanding the Biology of Halophilic Microorganisms. Springer Netherlands; 2012. p. 59–80.
  24. Oren A, Arahal DR, Ventosa A. Emended descriptions of genera of the family Halobacteriaceae. Int J Syst Evol Microbiol [Internet]. 2009 Mar 1 [cited 2021 Jun 23];59(3):637–42. Available from: <https://www.microbiologyresearch.org/content/journal/ijsem/10.1099/ijms.0.008904-0>
  25. Oren A. Diversity of Halophiles. In: Extremophiles Handbook [Internet]. Springer Japan; 2011 [cited 2021 Jun 24]. p. 309–25. Available from: <https://www.infona.pl/resource/bwmeta1.element.springer-c789b29f-2bc5-37f1-9203-fd1199a95267>
  26. Gao B, Gupta RS. Conserved indels in protein sequences that are characteristics of the phylum Actinobacteria. Int J Syst Evol Microbiol [Internet]. 2005 Nov 1 [cited 2021 Jun 24];55(6):2401–12. Available from: <https://www.microbiologyresearch.org/content/journal/ijsem/10.1099/ijms.0.63785-0>
  27. Maheshwari DK, Saraf M. Halophiles: Biodiversity and sustainable exploitation. Halophiles: Biodiversity and Sustainable Exploitation. Springer International Publishing; 2015. 1–449 p.
  28. Arahal DR, Castillo AM, Ludwig W, Schleifer KH, Ventosa A. Proposal of *Cobetia marina* gen. nov., comb. nov., within the family Halomonadaceae, to include the species *Halomonas marina*. Syst Appl Microbiol. 2002 Jan 1;25(2):207–11.
  29. Oren A. Industrial and environmental applications of halophilic microorganisms. <http://dx.doi.org/10.1080/09593330903370026> [Internet]. 2010 [cited 2021 Aug 9];31(8–9):825–34. Available from: <https://www.tandfonline.com/doi/abs/10.1080/09593330903370026>
  30. DasSarma S, DasSarma P. Halophiles and their enzymes: Negativity put to good use. Vol. 25, Current Opinion in Microbiology. Elsevier Ltd; 2015. p. 120–6.
  31. Enache M, Cojoc R, Kamekura M. Halophilic microorganisms and their biomolecules: Approaching into frame of bio(Nano) technologies. In: Halophiles: Biodiversity and Sustainable Exploitation. Springer International Publishing; 2015. p. 161–72.
  32. Amoozegar MA, Safarpour A, Noghabi KA, Bakhtiary T, Ventosa A. Halophiles and their vast potential in biofuel production. Vol. 10, Frontiers in Microbiology. Frontiers Media S.A.; 2019.
  33. Corral P, Amoozegar MA, Ventosa A. Halophiles and their biomolecules: Recent advances and future applications in biomedicine. Vol. 18, Marine Drugs. MDPI AG; 2020.







## A Gender Comparative Study of English Spelling Skills of Middle School Students

Bhaskaran Krishnamurthi<sup>1\*</sup> and J M Asgarali Patel<sup>2</sup>

<sup>1</sup>Research Scholar, Department of Psychology, Annamalai University, Annamalai Nagar, Tamil Nadu, India.

<sup>2</sup>Associate Professor, Department of Psychology, Annamalai University, Annamalai Nagar, Tamil Nadu, India.

Received: 27 Oct 2021

Revised: 16 Nov 2021

Accepted: 06 Jan 2022

### \*Address for Correspondence

#### Bhaskaran Krishnamurthi

Research Scholar,  
Department of Psychology,  
Annamalai University, Annamalai Nagar,  
Tamil Nadu, India.  
Email: bhaskarank@gmail.com



This is an Open Access Journal / article distributed under the terms of the **Creative Commons Attribution License** (CC BY-NC-ND 3.0) which permits unrestricted use, distribution, and reproduction in any medium, provided the original work is properly cited. All rights reserved.

### ABSTRACT

A gender comparative study of middle school students for English spelling skills based on Schonell Graded Spelling tests was conducted in Standard 7 in three schools in Chennai, India. The mean raw score for 67 girls was 30.28 versus 28.43 for 67 boys. All students were from the lower economic strata of society and low family educational background with very few parents at the graduate or higher levels. From the experimental z-value, a significant difference between the performance of boys and girls is seen in this study at 5% significance level, with girls performing better. This is conforming to the majority of earlier gender studies comparing academic performance. Significant gender differences in behavior were observed during the testing process. The girls were more disciplined and less noisy. Psychosocial factors underlying these are also briefly discussed, for devising strategies to improve the learning in such children by additionally focusing on the important social and family environments.

**Keywords:** Educational Assessment, Educational Psychology, ESL, Gender Studies, Language Learning, Psychosocial factors, Schonell Test, Spelling Skills.

### INTRODUCTION

This research study is aimed at triggering a movement to systematically measure skills across India at the school level, starting with basic skills like reading and writing, beginning with the lower socio-economic class students. Based on a standard test, the first objective was to get metrics on their skill levels. Comparison of the genders both on the quantitative metrics and on qualitative aspects, was the next step. Lastly qualitative observations and analysis

38284



**Bhaskaran Krishnamurthi and J M Asgarali Patel**

was done on the social and behavioral aspects of the students. This body of knowledge could help to arrive at pointers for improvements in the system of teaching and in the schooling ecosystem for effectiveness and efficiency. Since some of the children in lower economic classes in India may have disturbed environments at home, this is very important for understanding how the overall learning and education can be improved for children across society. This could apply to many other countries also, though this study is from Chennai city in South India. As English education has become very important universally, and has been researched much more widely with more published and standardized tests, we have started with spelling skills at middle school level with an internationally known standard graded spelling test. Such standardized tests need to be evolved or compiled with suitable scholars for native languages also, for widespread practice in the schooling system, as they may only exist in various bits and pieces currently.

**Background and Literature Study**

There have been several studies done on language learning aspects of school children globally. However, specific skill levels measurements especially in Indian lower socio-economic class schools, in academic research using standard tools are very few. There are many Indian reports and media articles primarily driven by NGO (Non-Government Organization) efforts. Teach for India working with poorer section schools had been doing bi-annual standardized assessment on comprehension and math skills developed in partnership with an external assessment company, for several years [1]. However, the results are not fully published. We note that many of these organizations are charitable, volunteer-driven service organizations, and often operate with non-formal educational programs for drop-outs and such sections of society, while some of them also have programs to supplement learning and skill-development for schools. Also, in the case of the school drop-out children, any exposure to formal academic skills helps them greatly. The contribution of the organization is more from the point of view of bringing a university-educated, empathetic, child-friendly mentor and guide to these impoverished children in disturbed family and social surroundings, and working more on their life skills and social adjustment aspects rather than a tutor following more clearly laid out learning objectives. While this approach is also helpful and important, it sidesteps the important aspect of improving the inherent processes and quality of teaching with the school with the regular teachers in the school. In addition, many of the NGO's have many young teachers with no real experience in handling school children. Only a few of them work with the existing teachers to improve the process in the schools. The complexity is more as India has many native languages, and some of the volunteers themselves may not be sometimes fluent in the native languages to help learning, especially at the early school levels.

As a firm scientific principle, measurements are needed for improvements and development. Though several programs are done in pockets, there needs to be a uniform country-wide (perhaps starting with a state-wide program) for such clear metrics to be obtained on basic learning aspects, like reading, writing and comprehension in both English and native languages, and math core skills. Some well-known programs like ASSET assessments run by the private organizations like Educational Initiatives (India) are more popular at the competitive levels and focus more on the upper and upper-middle economic section school children, with more emphasis on competitive assessments. As there are multiple native languages in India, the pedagogy approach for teaching English language is more complex from the national point of view. Several programs have been done where vernacular and native languages are used to deliver and help make English learning easier and more within grasp for the early-stage first-generation school-goers. A research study has observed that strict compartmentalizing of languages for learning, isolating social and linguistic identities, is not conducive to better learning [2].

We briefly note some important observations from earlier studies involving gender-based comparative studies of academic skills. Many of them are in varied cultural settings, countries and contexts, and we will review important observations from these studies. Many of them have reported that girl students perform better in academic skills. In a very large meta-analysis, females performed better overall in these studies, and more so in language skills compared to math skills [3]. Another study has analysed through student voices, the phenomenon of females performing academically better in Trinidad and Tobago schools [4]. In general, many of these findings throw light on some psychosocial factors like girl students being more disciplined and studious, attentive in class, and more hard-



**Bhaskaran Krishnamurthi and J M Asgarali Patel**

working in terms of putting in the effort to read and understand, by nature, perhaps due to local culture and traditions. The boys, perhaps because socially they are more likely to be outgoing, and more involved in physical sports and such activities, tend to be less disciplined and more rebellious, and thus not paying sufficient attention and efforts to the process of 'studying with a focus for academic performance'. Our current experimental study also has revealed similar observations during the process of testing, which is discussed under 'Qualitative Observations from the Study'. In a related study of gender differences, it has been observed that girls perform better academically because they are engaged more closely with the classroom and teaching processes, implying that the boys tend to not get actively involved [5]. However, this is not the case in Indian schools at the socio-economic categories that we have studied here, as the pedagogy and school processes do not make any differentiation, as observed by the researchers. The format of the tests influenced the performances [6]. We note that relatively fewer study results negated academic girl-superiority with a conclusion that the female superiority is very marginal and negligible [7]. It has been observed that the girl students are more disciplined leading to higher performances [8]. In a study in the American society with low-income families it was observed that girls whose mothers were employed showed higher scholastic achievement for single-parent families [9]. However, the concept of single-parent families is quite different in India in the lower income groups, as the incidence of children being born without a formal wedding is still much less than in the west, though it is increasing in recent years. Hence the single-parent families in India in these income groups are more because of a father who is irresponsible, or has deserted his family, rather than a case of someone who never wanted to have a family, and hence the psychosocial aspects could be very different. This aspect could vary across cultures and geographies and racial backgrounds, because of various psychosocial differences, and hence in India more of these studies are needed for educational improvements. No deterioration in academic achievements for children of working mothers, (but not necessarily single mothers) and higher levels of aspirations and achievements in girls of working mothers has been observed in USA [10]. The correlation between academic achievement and various attitudinal and situational factors, in young Canadian adolescents has been studied, and thus the importance of attitudinal factors has been established [11]. The effects of depression, death anxiety, divorce and such aspects of the family on the academic performance of among students, and differences between the genders for the same has been analyzed in Kansas High School students [12]. In all PISA (Program for International Students Assessment) studies of 2000, 2003, 2006, girls outperformed boys in reading skills in almost all the countries [13]. The study also analyzed many factors like home conditions, whether they own a computer at home, and other such factors. Thus, these studies are specific on some aspects of scholastic achievements and gender differences, and help in understanding the various aspects of learning and gender differences at a global level.

**Need for the Study**

This study is for specifically measuring basic skills, starting with spelling at critical stages of schooling, and specifically with the lower income category of schools in South India. In spite of being a very basic measurement, this would be very useful, as we need to get the fix on the foundational aspects before we move to complex parameters of scholastic excellence like problem solving and creativity. Gender-related differences in the lower economic strata in the society are complex. There are pervading popular opinions, perhaps due to a cultural bias, that the girl child is not educated as well as the boy child in India. However, we frequently find that in Tamil Nadu, in the state-affiliated schools, the girls perform better in academics at secondary school board levels, which is usually highly publicized news in the media. Thus, in addition to basic metrics, we have done this study also for a comparison between boys and girls in terms of one specific skill. The middle school has been chosen to start with, as it is the stage where the foundations get strengthened.

The objective of the present paper is to make a further contribution to the body of international research studies and knowledge in gender differences in academic skills starting with basic language skills, with specific studies in Indian schools. We have already observed the importance of such studies to analyse the psychosocial factors behind the students' learning abilities. Thus, we hope that our approach would be very important for measurements and improvements of the educational processes in India, especially for the schools catering to the lower socio-economic groups, as they could also lead to pointers on working with the family and social environment and background of the student, besides providing the basic metrics. Extensions of our study will be needed as we need to have



**Bhaskaran Krishnamurthi and J M Asgarali Patel**

measurements and studies in this environment for improvements in the educational system for the lower social-economic groups. In addition, our intentions of starting a movement for such measurements are relevant as India itself, in terms of population and cultural diversity within the same original lineage, is roughly equal to much more than all Europe put together. Population estimates as on date are in the ratio of 28:15, with India almost twice the population of Europe. The number of native languages in India is also as many as we can find in Europe. Hence the studies in these types of schools in a metro city like Chennai (where this study was done) may not be the same as in Assam or rural Orissa. We feel that these basic tests are much more necessary, compared to the last observed trends in PISA which as of now seem to be focusing on more high-level aspects like 'creativity'. Also, the issues of cultural bias, which was cited as the major reason why India earlier pulled out of the PISA assessment program in 2012, making global comparisons biased would be much less of an issue for basic skills like reading and spelling, and can be minimized by designing and adapting the tests suitably.

([https://en.wikipedia.org/wiki/Programme\\_for\\_International\\_Student\\_Assessment](https://en.wikipedia.org/wiki/Programme_for_International_Student_Assessment))

## MATERIALS AND METHODS

### Classification of Schools and Students for the study

In this study, we look at school students as an inclusive group, which may include a few in the border-line learning disabilities. The schools were selected from the lower-middle and lower class of society, since any improvement and measurements for improvements would be more necessary at these levels, while the middle and upper-middle class students would already be at a higher level. It may be noted that such tests, if conducted in the schools under the other categories especially the first two as given below, will result in higher average scores.

Here we observe some important background aspects and categories of the schooling system in the state of Tamil Nadu, India. There may be minor differences in other states, while this is based on that of Tamil Nadu. However similar categories are found in all other states, while some categories are more in number for some of the states. The schools may be categorized into four broad categories:

1. Private schools following the international educational boards
2. Privately funded and managed schools affiliated to the Central Government Education Board.
3. Government (Central Government) run Central Board Schools, also called as Kendriya Vidyalayas.
4. Private schools affiliated to the State Educational boards, privately funded
5. Private Schools affiliated to the State Educational Boards, and supported financially by the State Government.
6. Government run schools, coming under the State governments, affiliated to the State educational boards.

The students of these students could be considered as three categories, though this categorization is not very rigid, and there would be many overlaps in individual students as regards various factors like economic and social background. These three are (1,2), (2,3,4), and (4,5,6) from the above six types of schools, with overlaps of students in schools of categories 2 and 4 in two adjoining student background categories. This differentiation would be broad, and not by design or by school regulations, but more by the economics of affordability and peer grouping that happens naturally in society, and other social factors like native language differences among students. The students in these first few categories of schools have more support and nurture for learning and education at home with typically highly skilled professional and educated parents, some of them also in very high-income levels. For the last two categories the issues are infrastructure, investment and access to gadgets on part of the students and parents, as well as from the school management, with lack of organizational experience and training for the school management to technology like digital skills and multimedia-enabled classrooms. The higher income groups typically attend the private schools, and more recently, in the past twenty years, more academic achievement-oriented families prefer the Central-board of education to the state board, due to a higher level of standard, and peer group background, and the expectation that getting an admission into competition-based higher educational institutions for the degree programs



**Bhaskaran Krishnamurthi and J M Asgarali Patel**

and professional programs would be much easier with educational foundations in these schools. It is observed that the lowermost income groups usually enroll in the last two categories of schools. On the aspect of psychosocial factors, we note that the last category especially has more children who could be from impoverished families and families who have other social problems like broken families, alcohol addiction etc. Malnutrition could be another problem these children could face. The average educational levels of the parents of the students in the last two categories of schools, and in some schools of the third category also, would typically range from less than secondary school completion to maximum of a three-year arts or science degree or technical diploma or certification, with a very negligible number of parents with professional and post-graduate level degrees. Only one school, the privately funded one, in this study had a formal program to identify slow learners and learning disabilities, and provide some specialized support for such children, with limited dedicated and trained resources.

**The Test Instrument**

Schonell Graded Reading and Spelling Tests are among the most common, standardized and widely used tests for assessing spelling and reading skills, typically in the ages 6 to 14. They were developed by Fred Schonell in the 1960's, and still serve as a very good assessment method. Though frequently used to identify the students who are lagging behind, for formal assessments of academic learning propensity, they also serve a great need for comparison, or calibration of the skill levels of students. There are a few other tests, that are used more in American schools, and the basic principles behind most of these tests are similar, with certain execution and process differences. There are also minor differences between British and American spellings and this was also a factor while choosing the assessment method. While in universities and industry in India, American spellings and usages are widely found in written and spoken language, early school language education in the formal sector is based largely on the British spellings. A very important aspect of the Schonell method is that it is a graded test[14]. Both the spelling and reading tests have progressively difficult words, so that based on the extent to which the word list is done correctly by the student, their level would be determined. The raw score is the number of words spelt correctly. As this study focuses on comparing the students among the two genders, the grade-level equivalence assessment is not discussed here. It is our view as practitioners and researchers that one of the most important aspects of the measurements is to be able to set a direction for improving the educational delivery process, and make learning happen better, more effectively and efficiently especially for the students who are performing low.

Relative to the English language and modern spelling and phonic systems which have been in use for at least two hundred years, the Schonell tests are very much relevant and have been extensively used. They are currently available in public domain. The tests were evolved in close collaboration with Orton and Gillingham when they evolved the system of phonogram-based progressively complex and advanced spelling patterns (or spelling rules as they are also called) which form the basis for structured instruction and easy learning of spelling and reading skills. Thus, we observe that the Schonell spelling test word list is also structured in a similar way with initial words like 'cut', 'mat', and then slightly longer double-syllable words like 'sooner', 'headache', 'circus' and finally to longer words that are multi-syllable like 'individual', 'especially' and 'exaggerate', 'amateur' and 'committee'. These tests have been designed to give a good measure of spelling ability, in terms of word attack skills and syllable awareness. There are two standard test lists in the published Schonell Spelling Test, referred as Test 'A' and Test 'B'. As it is available in public domain, these two test word lists are not reproduced here fully. To illustrate the complexity variation, sections of the word list showing the first and the last ten words from the Schonell Test 'B' is given here below.

**Schonell Spelling Test B: First 10 words:**

see, cut, mat, in, ran, bag, ten, hat, dad, bed.

**Schonell Spelling Test B: Last 10 words:**

subterranean, apparatus, portmanteau, politician, miscellaneous, mortgage, equipped, exaggerate, amateur, committee.





### Bhaskaran Krishnamurthi and J M Asgarali Patel

These tests were administered to several students initially by the authors as part of the preliminary preparatory work in this study, on an individualized basis. For academic skills assessment of students who need to be assessed for reasons identified by the school to screen for potential learning disabilities, the testing is recommended to be done in an individual mode. However, since this study was not done with the objective of identifying the learning disabilities, though such inferences and pointers can also be an outcome from the test results. Hence, some implementation modifications were adapted in the process of conducting the test, to facilitate group assessment in a classroom setting where a maximum of 50 students were given dictation and instructions over a voice microphone and amplifier system for clear and uniform audibility for the entire group. The scores were used in its raw form to do the statistical analysis and hypothesis testing, since the purpose was not to basically identify the grade levels, but rather to compare the genders, and also to set an initial metric for reference for further research studies. However, as part of these studies an analysis of the levels of these school children was also presented to the schools, specifically flagging the outliers who were low in the score, and who may need special attention. The schools have found this very useful.

#### The Testing Process

The words were clearly read out in a line-by-line fashion, slowly, allowing the student sufficient time for listening and writing. Each word is repeated twice or thrice and a short sentence or phrase with the word could be also given, so that the context is understood better. As this was a group assessment, a few extra repetitions were also given for all students to listen clearly. Supporting teachers were present to ensure class control and to ensure a quiet and controlled ambience for more effective testing. The present study was done in two schools from the fifth category of schools, (one of them being boys' school and the other girls' school) and one from the fourth category, (where there are both boys and girls) catering to similar types of students in terms of socio-economic background. In the schooling system in many places in India and in Chennai Tamil Nadu where this study was done, there are co-education schools where in the same class both boys and girls study together and there are schools exclusively for girls and schools exclusively for boys. This study, apart from presenting the assessment results from the skill tests conducted, also presents several observations of behavior about the students from the experience in the testing and related interactive processes, and these aspects of gender-based differences are also discussed.

The quantitative analysis seeks to test the following hypothesis: (Null Hypothesis) There is no difference in the skill scores between the girls and boys, at 5 % level of significance.

## RESULTS

### Measurements from the study and Hypothesis Testing

No of boys tested:	67
No of girls tested:	67
Mean score of girls:	30.28
Mean score of boys:	26.43
Standard deviation of girls:	148.47
Standard deviation of boys:	274.74
Range of scores for girls:	60
Maximum/minimum score for girls:	62/ 2
Range of score for boys:	71
Maximum/ minimum score for boys:	75 / 4

Hypothesis: (Null Hypothesis) There is no difference in the skill scores between the girls and boys.

Since the group size is large, the z-test is used to verify the hypothesis. The difference in means is found out and the z value is calculated by





**Bhaskaran Krishnamurthi and J M Asgarali Patel**

$$Z = (X_1 - X_2) / \sqrt{\frac{\sigma_1^2}{n_1} + \frac{\sigma_2^2}{n_2}}$$

$$= 2.51$$

At 5% level of significance for the two-tailed test

R:  $|z| \geq 1.96$

The observed value of z is 2.51, which falls in the rejection region and thus we reject  $H_0$  at 5 % level.

Hence, we conclude that from these tests, that there is a significant difference between boys and girls in the spelling skills, with the girls scoring higher. The other significant observation is that both the standard deviation and the range of the scores for the boys is much higher than for the girls.

### Qualitative Observations from the Study

A comparison between the genders on the behavioral qualitative factors, relevant to the testing process is also significant. The tests were done in three schools. One of the schools had a mix of almost equal number of boys and girls in the group testing. The other two schools were boys-only and girls-only schools. A summary of major factors observed in terms of gender differences during the testing process is given here. These could have affected the testing process to introduce minor measurement errors but for simplicity the errors are ignored for the above qualitative study.

1. Time taken to settle down. For bringing the class to settle down from the assembly of the group for the group dictation test for spelling skills, the time taken for the boys-only group was significantly high compared to the time taken for the girls-only group.
2. The noise level during the testing itself was a factor. Though enough care were taken by the supporting staff to keep unnecessary sounds and noise to the minimum, it was significantly higher in the boys-only group. The ambient noise in the school atmosphere was significantly higher in the boys-only school.
3. Class control and disruptions in the testing process. The process of understanding the instructions, requesting for repeat of words, impatience from the group for the next words, and such aspects were observed more among the boys-only group. The boys-only groups, since there were more vociferous and not very less inhibited, proved to be a bigger challenge to run the testing program.
4. During the intervention program of running the skill-enhancement sessions, 'post-testing, as a part of the larger engagement with the school, absenteeism of the boys-only group was also higher. This observation is made here, as it is relevant to this aspect though not directly part of this study.
5. Certain individual traits in the boys' school came out strongly, with respect to initiative and proactive steps for facilitating the process, like volunteering to help in distributing the answer sheets, which was much more readily forthcoming in the boys-only group. As in the academic performance, the variation in the initiative, interest and involvement shown by the boys' group in the whole process also had more variation with some boys being very highly enthusiastic and looking actively to participate, and some boys completely disinterested in the whole process, whereas the variation to extremes in such aspects of the responses was less in the girls' school.

## DISCUSSION

A discussion of psychosocial factors from interviews with the school management and teachers revealed important information. The key points are given here. The children often came from families where the father was either not earning or working productively, alcoholic, absent, deceased or has deserted the family. In these cases, the mother



**Bhaskaran Krishnamurthi and J M Asgarali Patel**

happened to be a great support for the children, and the girl children were inspired and influenced by the diligence, discipline and hard-work of the mother. In a similar manner, the boys also seemed to be influenced by the father, even if he is absent, so much so, that the discipline and such aspects were very low. In addition, the social pressures for the boys when they do not come under the emotional protective cover of the mothers are more when they are still very young. The economic levels do not give them sufficient resources, with the result that often the boys have to give a helping hand in the business of their care-givers or father, resulting in them not being able to focus well and spend time on the academic learning to develop these skills. The influence from the other negative elements of the society around them like alcoholism, violent behaviors, and unhealthy surroundings also make it more difficult for them to focus on learning. Thus, to make the educational process more effective, the school management, and the ecosystem, along with possible Governmental support, need to have an inclusive plan for addressing the social and family ecosystems and surroundings for the children to make it more nurturing. In spite of the fact that many of these schools are highly subsidized by the government, and the school fees being minimal, some of the children often have difficulty even to regularly have two full meals in a day, which the Government-supported programs like 'Mid-day meals scheme' have alleviated to some extent. Thus, an extension of this analysis and study, to look into the family and social problems that the child is facing and help alleviate the disturbances would go a long way to improve the quality of learning for the same efforts in teaching, and the trigger could be from the scores of such assessment studies.

There could be further correlation studies between socio-economic factors like single-parent family and the scores, which could form basis for further research. Since these details could not be collected, also due to the difficulties in accessing more school data due to extended lock-down, online mode of educational delivery, and such disruptions due the global COVID pandemic for more than one year, the current study was only for the statistical study in the comparison of genders, with a brief summary discussion of the qualitative aspects of the psychosocial factors related to the testing process.

**CONCLUSIONS**

This study showed that girls performed better in spelling skills at middle school level in privately run and state-supported state-board affiliated schools catering to the lower socio-economic strata of students. The qualitative observations show that the girls and boys exhibited different behavioral traits, with the girls being more disciplined and manageable in the classroom and assessment process.

One of the primary recommendations in this research is that a very large-scale assessment based on these tests would go a long way in a pan-India skills improvement program, by identifying the students who need more support. Since many schools do not have a formal program for identifying slow learners and learning disabilities yet, these tests is made as a country-wide program would help in measurements leading to process improvements in educational delivery across the country. It will help flag out the outliers among students who could be at the two ends of the skill-levels. Thus, by helping the educational system and the teachers to focus on those lower-skilled children, who are normal learners, but had not picked up good skills, due to environment issues, that the average skill levels can be significantly improved. Often competitive assessments and looking for the 'top performers' in any test or exam, even as part of the routine schooling system tend to over-emphasize the importance of top performers. However, the overall level of education and awareness in the country and society can be better improved by focusing on the larger groups which are performing around average to be below average in skill levels. These will result in more efficiency and effectiveness of the educational delivery. Even a very simple step like extra attention from the teachers, for those who perform in the bottom 25 %, would go a long way in improving the educational delivery. As observed earlier, programs like PISA and ASSET would not fill this need, and there needs to be an internal country-specific program.

Large scale Government-supported program would help in improving learning across the society, especially for the socio-economic groups that are in dire need of such improvements. If the measurements are focused on such basic





**Bhaskaran Krishnamurthi and J M Asgarali Patel**

skills initially on a wider basis in the country, the development of higher levels of cognitive and skill-based performance levels (like comprehension and creativity) can be addressed more easily in the next stages. The skills can cover reading, spelling, basic arithmetic operations, simple vocabulary, and comprehension of sentences initially. It can move on to passage comprehension and such aspects, which may not need so much of widespread standardized testing, in our opinion, as the academic curriculum is already designed to address these fairly well. Some standardization of testing and metrics at certain milestone standards (grades) like 5<sup>th</sup> Standard, or 8<sup>th</sup> Standard will help in improving the process of educational delivery. Initially on a city-wide basis, and later on a state-wide basis, extending to national levels would help the improvement of educational processes across the country and help prepare our youth better for life in this global competitive world. As a firm scientific principle, whatever is measured can be better controlled or improved. Thus, these tests and analysis of the test results periodically and systematically, will definitely lead to programs for improvements in skills and better skill-development programs. Last but not least, similar testing if done for the native language skills also, as part of (or linked to) the regular schooling, can lead to improved levels of actual learning at school levels. The behavioral observations as given above under Qualitative Observations from the study also reveal important aspects, giving key pointers to improvements for making the learning better at these school levels, by positively addressing the negative family and social issues.

**REFERENCES**

1. TeachForIndia. <https://www.teachforindia.org/our-model/>
2. Kalia V., & Reese, E. (2009). Relations Between Indian Children's Home Literacy Environment and Their English Oral Language and Literacy Skills, *Scientific Studies of Reading*, 13:2, 122-145. <http://dx.doi.org/10.1080/10888430902769517>
3. Voyer D., & Voyer S. D., Gender Differences in Scholastic Achievement: A Meta-Analysis, University of New Brunswick. *A Psychological Bulletin* © 2014. American Psychological Association 2014, Vol. 140, No. 4. 1174–1204. <http://dx.doi.org/10.1037/a0036620>
4. Jackman & Morrain-Webb. (2019). Exploring gender differences in achievement through student voice: Critical insights and analyses, *Cogent Education*, Volume:6 Issue: 1. DOI: 10.1080/2331186X.2019.1567895
5. Payne, J.(2020). Gender Test Score Gaps Under Equal Behavioral Engagement, *Educational Researcher*, Volume: 49 issue: 6, Page(s): 459-464 <https://doi.org/10.3102/0013189X20930203>
6. Reardon S. F., Kalogrides D, Fahle E. M., Podolsky A., & Zarate R. C.(2018). The Relationship Between Test Item Format and Gender Achievement Gaps on Math and ELA Tests in Fourth and Eighth Grades. *Educational Researcher*, Volume 47, issue: 5. Page(s) 284-294. <https://doi.org/10.3102/0013189X18762105>
7. Hyde, J. S., & Linn, M. C. (1988). Gender differences in verbal ability: A meta-analysis. *Psychological Bulletin*, 104, 53–69. doi:10.1037/0033-2909.104.1.53
8. Duckworth, A. L., & Seligman, M. E. P. (2006). Self-discipline gives girls the edge: Gender in self-discipline, grades, and achievement test scores. *Journal of Educational Psychology*, 98, 198–208. doi:10.1037/0022-0663.98.1.198
9. Alessandri, S. M. (1992). Effects of maternal work status in single-parent families on children's perception of self and family and school achievement. *Journal of Experimental Child Psychology*, 54, 417–433. doi: 10.1016/0022-0965(92)90028-5
10. Banducci, R. (1967). The effect of mother's employment on the achievement, aspirations, and expectations of the child. *Personnel & Guidance Journal*, 46, 263–267. doi:10.1002/j.2164-4918.1967.tb03182.x
11. Banreti-Fuchs, K. M. (1972). Attitudinal and situational correlates of academic achievement in young adolescents. *Canadian Journal of Behavioral Science/Revue canadienne des sciences du comportement*, 4, 156–164. doi:10.1037/h0082299
12. Brubeck, D., & Beer, J. (1992). Depression, self-esteem, suicide ideation, death anxiety, and GPA in high school students of divorced and nondivorced parents. *Psychological Reports*, 71, 755–763. doi:10.2466/pr0.1992.71.3.755
13. Lynn, R., & Mikk, J. (2009). Sex differences in reading achievement. *Trames*, 13, 3–13. doi:10.3176/tr.2009.1.01





**Bhaskaran Krishnamurthi and J M Asgarali Patel**

14. Smith, C. F., Jr., & Harrison, M.D. (1983) A Comparative Analysis of Three Widely Used Graded Word Reading Tests. Paper presented at the Annual Meeting of the Great Lakes Regional International Reading Association (5th, Springfield, IL, October 5-8,1983), © Educational Resources Information Centre, National Institute of Education, US Department of Education. <https://files.eric.ed.gov/fulltext/ED235473.pdf>





## Image Processing based Information Hiding Technique using Dimension Reduction and Fuzzy Logic

Z. Faizal Khan<sup>1\*</sup> and Asim Seedahmed Ali Osman<sup>2</sup>

<sup>1</sup>College of Computing and Information Technology, Shaqra University, Kingdom of Saudi Arabia.

<sup>2</sup>College of Computer Science and Engineering, University of Hafr Al batin, Kingdom of Saudi Arabia.

Received: 16 Nov 2021

Revised: 18 Dec 2021

Accepted: 13 Jan 2022

### \*Address for Correspondence

**Z. Faizal Khan**

College of Computing and Information Technology,  
Shaqra University,  
Kingdom of Saudi Arabia.  
Email: faizalkhan@su.edu.sa



This is an Open Access Journal / article distributed under the terms of the **Creative Commons Attribution License** (CC BY-NC-ND 3.0) which permits unrestricted use, distribution, and reproduction in any medium, provided the original work is properly cited. All rights reserved.

### ABSTRACT

A novel image processing based steganographic technique using the combination of fuzzy logic and Dimension reduction technique is proposed in this paper that would enhance impressively the entire steganography process practiced nowadays. This method attempts the process of steganography of a secret image which is to be embedded with a carrier image. This methodology will keep the data as safe from intruders. Initially, the secret image as well as the carrier image has to be reduced and equalized using the dimension reduction technique. Then, Merging the Pixel process is performed by the combination of fuzzy rules and the pixel matching algorithm. This method compares all the pixels of both secret and the carrier images. The fuzzy rules are applied for both the images from the initial pixel to the last pixel. The suggested approach embeds the hidden image in the carrier image more effectively based on the experimental results. Future enhancement is to improve the proposed methodology to secure more large resolution images for maintaining information security

**Keywords:** Image processing, Steganography, Contrast, Carrier Image, Pixel Matching, Secret Information.

### INTRODUCTION

Maintaining secrecy and security of confidential data over the internet and cloud is very important nowadays. Cryptography and steganography are both techniques which can be used together to maintain the security and secrecy challenges to the highly confidential data over the computing environment. Steganography is the method of providing information security for secret images which can a string of characters by inserting the message within other messages as a carrier image. The proposed methodology provides more than one level of security since it is combined of the value and also the texture features of all the pixels present in the entire image. Steganographic



**Faizal Khan and Asim Seedahmed Ali Osman**

methodology has been developed for generations, with significant improvements in medium and hidden images for maintaining safety [16]. Data, which is hidden in images are most commonly used as input [2, 3]. In this case, the medium which is concealing the data is a picture. The image will be represented by two-dimensional parameters  $f(x, y)$ , where  $x$  and  $y$  are the conceptualization co-ordinates and  $f$  is the brightness [1]. During this procedure, the image is transformed into a two-dimensional matrix, with each purpose represented by its own rows and columns. It also has a moderate level of brightness to it. The fundamental purpose of this technology transfer is to convey a fast and simple interchange of digital data across the internet. The security of data in images has been a critical area of analysis due to the ease of this technology and replication of the information [18]. During this proposed methodology, a text that is to be embedded in a picture is a grey image. The fuzzy rule-based region merging procedure will be used to implement this strategy. The recipient will just receive the encoded text, and he is the only one that is informed of the defuzzification procedure. The most significance of this planned methodology is, it will be used simply by any end user. This technique only concentrates on methodology which is supported by a picture that is used due to its capability of carrying hidden data and thus it's trouble some to seek out a steganographic knowledge from a standard digital image.

**Literature Review**

Many techniques for information hiding were projected by recent researchers in [4-9, 12-15, 19-20]. In this work, numerous steganography techniques that were supported by fuzzy based techniques has been mentioned in the survey. [17] proposed a method for information hiding. In their methodology, they tried to hide the data using a domain supported fuzzy logic-based methodology. The benefits of this methodology are computationally less expensive once it's compared to existing data hiding strategies. Their methodology provides a skillfulness and safety in embedding the messages from common attacks, similarly as acceptable by the physical property and payload capability. However, the information which is to be hidden is sensitive in nature and it's easy to be destroyed by creating a little amendment with in the overall data and by dynamical with none explicit visibility. Toony and colleagues suggested a technique for replacing data in images. A confidential data like a picture is hidden using a proposed fuzzy technique and cryptography technology in their approach. A fuzzy system assumes that each block in the confidential information is contained within a new unit and using model-based steganography to conceal the entire information in a carrier image. This results in little deformation throughout the image, resulting in a high-quality stego image. Main advantage of their projected methodology is it yields a better rate in embedding the information and there is an improvement with in the overall security. Anderson [8] designed a strategy supported by the mix of a hybrid fuzzy c-means formula and SVM for proposing steganography. Their projected model creates an activity such that the key messages are convertible.

Provos N. and Honeyman [15] developed a replacement schema for steganography by least bit technique for utilizing the hybrid-based edge detector technique. Their solution combines feature detection techniques with edge detection techniques that are backed by fuzzy logic. This technique replaces the previous approaches for steganalysis systems, which are based on available analytical process. It also makes high-resolution stego images. Every steganography based method has its own set of draw backs Petitcolas et al. [12] emphasized the drawbacks of existing steganography methods. Image steganography attacks are defined as the alteration of data in a visual medium. These are frequently defined in a variety of ways that can be based on a variety of information hiding approaches. In their paper [7], Craver et colleagues define three types of stego attacks: attacks on toughness, attacks on display, and attacks on perception It has been determined that the majority of the dominant works were used based on the works discovered within the surveys. Threshold-based methodologies, Fuzzy C-means methods, and neural network-based methodologies are all examples of threshold-based methodologies. However, just like in clinical uses, the accuracy supplied by multiple stages of segmentation is insufficient to make meaningful decisions. Furthermore, most existing approaches have been found to be less accurate at concealing images with more data. As a result, new and efficient methods for efficiently embedding the most effective content in a carrier image are required.





**Faizal Khan and Asim Seedahmed Ali Osman**

### Proposed Methodology

For hiding the secret image in a carrier image, a combination of dimensionality reduction and fuzzy logic based pixel matching techniques is given. Because the dimensionality reduction approach is applied, this method resulted in an efficient steganography technique, even if the secret information is of greater quantity. Since there are two types of images, the resolution will be high. In this case, application of the fuzzy logic and pixel matching algorithms is impractical since it takes more time for the computation. Hence, the overall size of the input images should be reduced and equalized. It is done by dimension reduction process that is the method of resizing a digital image through ever-changing its resolution. To reduce the image size and make it equal, a method called Principal Component Analysis (PCA) is done. The fuzzy set theory oriented pixel detection algorithms is then used to incorporate the information provided in the encrypted data into the carrier image.

The closest pixels were clustered based on the similarity between their pixels. The similar pixels were then clustered and combined using the fuzzy logic. The rule is shown in section 3.3. The overall architecture for the proposed design is shown in figure 1.

### Dimension reduction

A dimension is a description of a specific aspect of an entity. Dimension reduction is the process of reducing the measurement which describes the object. The primary purpose of background subtraction is to eliminate spurious data in order to reduce the cost of computation and over-fitting data in order to enhance data quality. Reduction in the background can be used in a variety of applications, including pattern classification and data analysis. In this paper, the PCA [7] shown in figure 1 is used as the dimension reduction method for reducing the dimension of the given input image. In this method, the class information is not considered. The fundamental idea of this technique is to find a collection of  $d$  orthogonal column vector that preserves the connection between both the original sizes to the greatest extent possible.

Feature selection, linear or nonlinear, controlled or uncontrolled, and local or global are some of the several types of dimensional reduction approaches. Principal components analysis comes under the linear methods such and it uses a linear mapping in order to extract new features from original features for the process of reduction.

### Computation of Number of the pixel and Contrast value

The pixel value is used to determine where in the actual picture the pixel from the encrypted data is combined. It can be utilized on the recipient side when obtaining messages from stego-image. As an enhanced security precaution, the contrast value is calculated. For the complete image, the contrast calculates the brightness between a pixel and its neighbour. The contrast levels for both the pixels in the source image are computed and blended with the pixel containing information from the hidden image. The following is the formula for evaluating pixel contrast.

$$Co = \sum_{i,j} |1 - j|^2 p(i,j) \quad (1)$$

An attacker attempting to identify or manipulate confidential message will be unable to forecast or compute the intensity value of each pixel in which the data was concealed. This shows that the information could be decoded without that both source and the recipient's knowledge.

### Fuzzy based Pixel Matching

In this work, a completely unique approach of fuzzy logic based Matching algorithmic rule is developed. Analysis could be a form of many-valued logic; it manages thinking that's inexact rather than matured and corrects [6]. It could be a kind of multivalent reason during which the reality values of variables are out lined as any complex quantity between zero and one. The Fuzzy management Systems are a development of a logic that permit for terribly





### Faizal Khan and Asim Seedahmed Ali Osman

precise management of robotic systems. The Fuzzy set is that the foundation of an instability hypothesis, associated a device for each linguistics and numerical framework. The image is processed from first to last pixels in this work. Firstly, only the set of six pixels is taken into account. The fuzzy rules are used to determine if the pixels are grey or black in this case. The image has just black and grey pixels because it has been transformed to gray image. If the pixel is black, then skip the first set of six pixels and go to the seventh pixel. If the pixel is grey, group all the pixels in to one and change it to white. Continue the cycle till all the pixels have been read and modified. Below are compon components of the proposed algorithm for fuzzy pixel clustering and matching.

Algorithm for fuzzy logic-based pixel Matching

Step.1: Scan both the image from the first pixel

Step.2: Compute the Pixel number and Contrast value for both the images

Step.3: Set  $P_0$  = first pixel of Carrier image

Step.4: Set  $P_1$  =first pixel of secret image

Step.5: if  $P_0 = P_1$  =black,

Step.6: Then, Merge both the pixels and go to next pixels

Step.7: if  $P_0 =$  Black,  $P_1 =$ White,

Step.8: Then, Skip to the next pixels

Step.9: if  $P_0 =$  White,  $P_1 =$ Black,

Step.10: Go to step 8

Step.11: if  $P_0 = P_1 =$ White,

Step.12: Then, Go to step 6

Step.13: Repeat the process till last pixel

Step.14: End

#### Decrypting the message

Number of the pixel of original combined with the feature values are the key and it is given towards the receiver. The receiver will extract the data which is hidden from the original image by distinctive the proper picture element and by subtracting the texture feature values from it so as to get the first picture element from it. Since the picture element combined with the texture feature values are taken into account as a key for extracting the hidden data, this method is considered as secured in comparison to different existing steganographic techniques.

#### Experimental Results

This steganographic technique is done using Matlab R 2014a version. From the results obtained, it is clear that the secret image which is hidden in the carrier image is visually indistinguishable in nature. Both the images which is used as carrier, and the secret image is shown in figure 3. The overall accuracy of this method is revealed from the metrics such as Peak Signal to Noise Ratio (PSNR) and The Mean Square Error (MSE) values. These metrics are generally used to compare the overall quality of a computed image. In this paper, these metrics are used to compare the processing quality between both the images after and before the processing. The PSNR value denotes the amount of peak error. Hence, when the PSNR is higher then, the quality of processes image is high. MSE is the overall cumulative of the squared error between both the images. Henc, when the value of MSE value is less, then the amount of error which is present in the image is apparently less. These metrics are as follows:

$$\text{PSNR} = 10 \log_{10}(R^2/\text{MSE}) \quad (2)$$

The number of rows and columns in the source image, correspondingly, are M and N. Then PSNR value can be computed as follows:

$$\text{MSE} = \frac{\sum_{M,N} [I_1(m,n) - I_2(m,n)]^2}{M*N} \quad (3)$$

where, R is the maximum fluctuation in the input image data type.



**Faizal Khan and Asim Seedahmed Ali Osman**

Obtaining a less in the MSE values and a peak of PSNR values is suitable to endeavor the efficiency of a steganographic technique. These values represent the overall quality of the image which is obtained as output from the proposed algorithm. The proposed steganography technique produces a better output. Table 1 shows the PSNR and MSE values for a couple of the data set as hidden and source images, as well as the precision gained from them. The projected methodology is compared with RSA based technique [5] and LSB based steganography technique [4]. Considering on PSNR and MSE values, the results show that this methodology performs better than the LSB and RSA approaches. The time taken to process the overall algorithm is also computed in order to find the efficiency of the proposed methodology. It is shown in table 2.

**CONCLUSION**

A new steganographic technique is proposed in this paper by the combination of Dimension reduction fuzzy based pixel matching in order to hide the secret message in a carrier image. This method can hide the images in a better way even the image is bigger in size. This method is also awesome based on the time taken to hide the secret image in to the carrier image. The obtained results from the PSNR and MSC values shows that this method shows a better endeavor for steganographic technique with the required information as image in another image when compared to other steganographic techniques. This methodology has a good result in the overall steganographic process. This method is more secured in information hiding because the intruder can't retrieve the hidden image unless the fuzzy rules are known. The overall performance of the proposed method is tested by the PSNR and MSE based metrics.

**REFERENCES**

1. Image definition, Gonzalez, Woods – Digital Image Processing.
2. Z Neil F. Johnson and SushhilJajodia. "Steganalysis: The Investigation of Hidden Information" - Proceedings of the IEEE Information Technology Conference, Syracuse, New York, USA, 1998.
3. I.Aveibas, N.Memon, B.Sankur. "Steganalysis based on image quality metrics", IEEE Fourth Workshop on Multimedia Signal Processing, vol.16, no.7, pp.162- 107,2001.
4. A.S.Abdullah, "Text Hiding Based On Hue Content In HSV Color Space", International Journal of Emerging Trends & Technology in Computer Science, vol. 4, Issue 2, pp. 170-173, 2015.
5. MamtaJaina,Saroj Kumar Lenkab, Sunil Kumar Vasistha, "Adaptive circular queue image steganography with RSA cryptosystem", Perspectives in Science, Vol. 8, pp. 417—420, 2016.
6. Petitcolas, F.A.P., Anderson, R.J., and Kuhn, M.G., "Information hiding-a survey," Proceedings of the IEEE international conference on information technology, vol.87, no.7, pp.1062- 1078, 1999.
7. Craver S., Yeo B.-L., and Yeung M., "Technical trials and legal tribulations." Communications of the A.C.M., vol.41, no. 7, pp. 44-54, 1998.
8. Anderson, R.J. and Petitcolas, F.A.P., "On the limits of steganography," IEEE Journal on Selected Areas in Communications, vol.16, pp.474-481, 1998.
9. Cheddad A., Condell J., Curran K., and McKeivitt P., "Digital image steganography: Survey and analysis of current methods," Signal Processing, vol.90, pp.727-752, 2010.
10. Dhall, A, Asthana A, Goecke R, Gedeon T (2011) Emotion recognition using PHOG and LPQ features. In Automatic Face&Gesture Recognition andWorkshops (FG2011), IEEE International Conference, pp 878–883
11. Evelyn Santana Mantuano, Washington Xavier Garcia-Quilachamin, Jorge Anchundia Santana,A Systematic Review of Algorithms in People Images Detection Based on Artificial Vision Techniques for Energy Management in Air Conditioners, International journal of online and Biomedical Engineering, Vol 17, No 01, 2021.
12. Xianfeng Yang, XiaojianJia, Multi-frame Image Processing Based on Wireless Sensor Networks, International journal of online and Biomedical Engineering, Vol 14, No 10, 2018.
13. S., Petitcolas F.A.P. (Eds.), Information Hiding Techniques for Steganography and Digital Watermarking, Artech House, Inc., Norwood, 2000.





**Faizal Khan and Asim Seedahmed Ali Osman**

14. Miaou S., Hsu C., Tsai Y., and Chao H., "A secure data hiding technique with heterogeneous data-combining capability for electronic patient records," in: Proceedings of the IEEE 22nd Annual EMBS International Conference, pp. 280–283., 2000.
15. Abdul Khader Jilani Saudagar, Biomedical Image Compression Techniques for Clinical Image Processing, International journal of online and Biomedical Engineering, Vol 16, No 12, 2020.
16. Provos N. and Honeyman P., "Hide and seek: an introduction to steganography," IEEE Security and Privacy, vol.1, no.3, pp.32–44, 2003.
17. Khursheed F. and Mir A.H., "Fuzzy logic-based data hiding," In Proceeding of Cyber Security, Cyber Crime, and Cyber Forensics, Department of Electronics and Communication, National Institute of Technology, Srinagar, India, 2009.
18. Mir A.H., "Fuzzy entropy based interactive enhancement of radiographic images," In Journal of Medical Engineering and Technology, vol.31, no.3, pp.220–231, 2007.
19. Hussain H.S., Aljunid S.A., Yahya S., and Ali F.H.M., "A novel hybrid fuzzy-SVM image steganographic model," In Proceeding of International Symposium in Information Technology, vol.1, pp.1-6, 2010.
20. Zhi-go Wang, Wei Wang, Baolin Su, Multi-sensor Image Fusion Algorithm Based on Multire solution Analysis, International journal of online and Biomedical Engineering, Vol 14, No 06, 2018.

**Table1: Accuracy based on PSNR and MSE**

Image	PSNR (RSA based method)	MSE (RSA based method)	PSNR (LSB based method)	MSE (LSB based method)	PSNR (Proposed method)	MSE (Proposed method)
Image 1	58.0288	0.01176	53.1268	0.01184	59.1268	0.01044
Image 2	59.0198	0.01084	58.0918	0.01390	62.0918	0.0190
Image 3	62.1187	0.02217	62.0435	0.02306	63.0435	0.01106
Image 4	59.0198	0.01196	55.0211	0.01293	56.4101	0.0293
Image 5	59.0139	0.02164	57.9131	0.02142	60.3731	0.01142

**Table 2: Execution Time (in seconds) for method with and without dimension reduction**

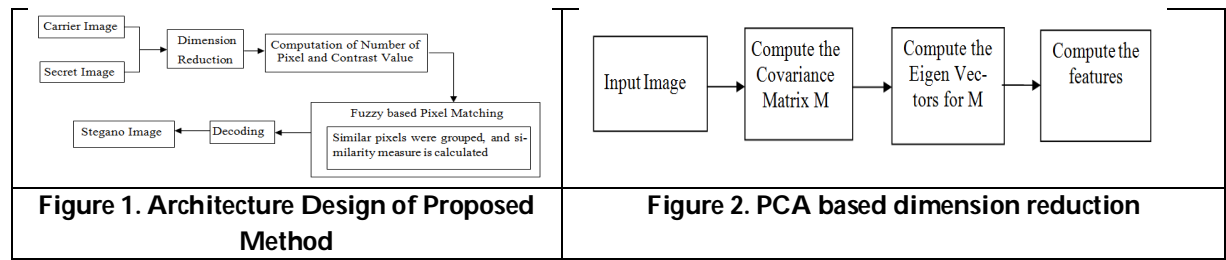
IMAGE	Without Dimension reduction		With dimension reduction	
	Time Taken for Existing Method (In Seconds)	Time Taken for Proposed Method (In Seconds)	Time Taken for Existing Method (In Seconds)	Time Taken for Proposed Method (In Seconds)
Image 1	368	384	347	224
Image 2	438	497	429	411
Image 3	466	487	427	416
Image 4	459	465	392	323
Image 5	456	477	417	405







**Faizal Khan and Asim Seedahmed Ali Osman**



**Figure 1. Architecture Design of Proposed Method**

**Figure 2. PCA based dimension reduction**

No	Carrier Image	Secret Image	Stegano Result
1			
2			
3			
4			
5			

**Figure 3: Proposed outputs carrier, secret image and its output**





## Knowledge of Women Regarding Domestic Waste Management in Chinnaseeragapadi, Salem

M.Sathyakala<sup>1\*</sup> and A.Prabhakaran<sup>2</sup>

<sup>1</sup>Assistant Professor, Department of Child Health Nursing, Vinayaka Mission's Annapoorana College of Nursing, Vinayaka Mission's Research Foundation- Deemed to be University, Chinnaseeragapadi, Salem -636308, Tamil Nadu, India.

<sup>2</sup>Tutor / Ph.D Scholar, Department of Community Health Nursing, Vinayaka Mission's Annapoorana College of Nursing, Vinayaka Mission's Research Foundation- Deemed to be University, Chinnaseeragapadi, Salem -636308, Tamil Nadu, India.

Received: 28 Oct 2021

Revised: 04 Dec 2021

Accepted: 06 Jan 2022

### \*Address for Correspondence

#### M. Sathyakala

Assistant Professor,  
Department of Child Health Nursing,  
Vinayaka Mission's Annapoorana College of Nursing,  
Vinayaka Mission's Research Foundation- Deemed to be University,  
Chinnaseeragapadi, Salem, Tamil Nadu, India.



This is an Open Access Journal / article distributed under the terms of the **Creative Commons Attribution License** (CC BY-NC-ND 3.0) which permits unrestricted use, distribution, and reproduction in any medium, provided the original work is properly cited. All rights reserved.

### ABSTRACT

A non experimental descriptive design with cross sectional survey approach was undertaken to assess the knowledge of women in domestic waste management in Chinna seeragapadi village, Salem. 50 women were selected by convenient sampling technique and data were collected by using closed ended knowledge questionnaires. The finding revealed that women of highest percentage 38% of them were between age group of 36-40 years. Most of the women 40% of them had primary school education. Daily wages shows the highest percentage 44%. Monthly income shows that highest percentage 44% of women had family income between Rs 3001- 5000; it seems that women were from low social economic group. Most 54% of women were from nuclear family. All most 100% of women belong to Hindu. Percentage wise distribution knowledge score of women regarding knowledge of domestic waste management shows that 44% of the women scored average knowledge, where as 42% of them score good knowledge, Further 10% score very good knowledge and only 4% of women score poor knowledge hence it is interpreted that majority of the women have average knowledge about effect of domestic waste.

**Keywords:** Knowledge, Domestic Waste management, Women

### INTRODUCTION

Many hazards are being caused due to the clumping of domestic waste. In at least conducted by laboratories of biologic environment in francs, absence of salmonella in groundwater was found this may be due to sensitivity to disinfectant. This study clearly indicates the role played by E-coli and enterococci as biomarkers of recent faecal





### Sathyakala and Prabhakaran

contamination. (Ballet, 2012). The right platform Indian government is now to set up various waste disposable management units, recycling technological investment and hazardous waste management and technological uplifting. India international recycle and waste management exhibition (IRWM) 2010 really to provide a co-ordinate platform international industry leader; providers and seeker to show case their products and services on recycle and waste sector professional companies co-operates and industries. (Kasha Swarnakar, 2011)

#### Need for study

Methods of solid waste management vary greatly with types of wastes and level condition among people proper. A women's organization tried to convince people of the needs for waste management. In India, recent debacles there have been significant growth in urban population. Receiving enough space for related to problems. To comfort with one such problems is about improving environmental particularly through solid waste management. (Kershaw Swarnakar, 2012)

#### Statement of the problem

Assess the knowledge of women regarding domestic waste management in Chinnaseeragapadi, Salem.

#### Objective

To assess the women knowledge regarding domestic waste management

#### Research design and approach

A non experimental descriptive design with cross sectional survey approach

#### Setting of the study

The study was conducted in Chinnaseeragapadi village, Salem district.

#### Population

The population of this study was women in the age group of 25-40 years in Chinnaseeragapadi village, Salem district.

#### Sample size

Sample size was 50 women from Chinnaseeragapadi village, Salem district.

#### Sampling technique

Non-probability convenient sampling technique was used for this study

#### Development of the tool

The questionnaire was prepared by reviewing books and journals related to topic and by the consultation of the expert during the preparation of tool.

#### Tool used

Closed-ended questionnaire was used to collect the data related to knowledge of women regarding the domestic waste management.

## RESULT AND DISCUSSION

A non experimental descriptive design with cross sectional survey approach was undertaken to assess the knowledge of women in domestic waste management in Chinnaseeragapadi village, Salem. 50 women were selected by convenient sampling technique and data were collected by using closed ended knowledge questionnaire. The





### Sathyakala and Prabhakaran

finding revealed that women of highest percentage 38% of them were between age group of 36-40 years. Most of the women 40% of them had primary school education. Daily wages shows the highest percentage 44%. Monthly income shows that highest percentage 44% of women had family income between Rs 3001- 5000; it seems that women were from low social economic group. Most 54% of women were from nuclear family. All most 100% of women belong to Hindu. Percentage wise distribution knowledge score of women regarding knowledge of domestic waste management shows that 44% of the women scored average knowledge, where as 42% of them score good knowledge, Further 10% score very good knowledge and only 4% of women score poor knowledge hence it is interpreted that majority of the women have average knowledge about effect of domestic waste.

## CONCLUSION

In the present study it can be concluded that majority of the women have average knowledge on effect of domestic waste management. Hence, it can be interpreted that the investigator needs to conduct experimental study to assess the knowledge on effect of domestic waste management

## REFERENCES

1. Park .K, (2011), "Text book of preventive social medicine", 20<sup>th</sup> edition, M/s Banarsidas bhanot publication, Pp. No.561-563.
2. Simona Ciuta, Tiberiu Apostol, and valentine rules published : 14 January 2015: urban and rural msw stream characterization or separate collection improvement.
3. Surat Sing, Aravind Kumar, Sarita Nagari, Volume 3 issue : 6, (June, 2013) Generation and management of domestic solid waste at rural area of Jammu District, J&K, India.
4. Fakeralexander .A' Fadairo Gabried Vol. 2 no. 5, May: 2012. International journal of engineering and technologies. Domestic waste management and urban residential environment focus on Akure, Nigeria .
5. Mohd Shah, Hafizhim Aminuddin and Haliza Addul Rahaman. Vol.6 No. 8 August 2015, International journal of environmental science and development. Health risk survey for domestic waste management. Agency workers : Lase study on Kota Bharu municipal council (MPKB), Kelantam, Malaysia.
6. The author reached at: azim-ptham@legalservice India .com

### Percentage of level of knowledge score obtained by women on domestic waste management

Grade	Score	Number of adult	Percentage
Poor	1 – 6	2	4%
Average	7 – 12	22	44%
Good	13 – 18	21	42%
Very good	19 – 24	5	10%
<b>TOTAL</b>		<b>50</b>	<b>100%</b>





## Quest of Motherhood, Racism and Self-Identity in Maya Angelou's *Letter to My Daughter*

Manisha Sharma<sup>1</sup> and Yashoda Verma<sup>2\*</sup>

<sup>1</sup>Research Scholar, Department of Languages, Manipal University Jaipur, Jaipur, Rajasthan, India.

<sup>2</sup>Asst. Professor (Selection Grade), Department of Languages, Manipal University Jaipur, Jaipur, Rajasthan, India.

Received: 01 Nov 2021

Revised: 16 Dec 2021

Accepted: 06 Jan 2022

### \*Address for Correspondence

#### Yashoda Verma

Asst. Professor (Selection Grade),

Department of Languages,

Manipal University Jaipur,

Jaipur, Rajasthan, India.

Email: dryash612142@gmail.com



This is an Open Access Journal / article distributed under the terms of the **Creative Commons Attribution License** (CC BY-NC-ND 3.0) which permits unrestricted use, distribution, and reproduction in any medium, provided the original work is properly cited. All rights reserved.

### ABSTRACT

Maya Angelou (Marguerite Annie Johnson) born on April 4, 1928, was an African American writer, poet, civil activist. She has written several autobiographies, essays, novels, and poems but she is acknowledged for her autobiographies that focus on her puerility and early adult experiences. One of her famed autobiographies '*I Know Why the Caged Bird Sings*' discusses the aspects of her memoir. She has been an interpreter for many African folks and her exertion has been reckoned as a fortification of African culture. Most of her work narrates about the struggle and worst experiences of African American people being discriminated against in America. The work *Letter to My Daughter* (2008) elucidates the motherhood, love, death, and struggle of Angelou's life. The novel articulates the trials of black women in search of self, identity, racism and brings out the struggle of a black woman in society. Each chapter of the novel is equipped with the story of experiences of her life and enlightens the darkest days of her life which gives lessons to the reader. This study is an observation of the work '*Letter to My Daughter*' to discuss the struggle and darkest period of Angelou and to bring out the emotions of motherhood and self-identity that have shaped her life. It explores how the environment plays an important role in human development and how the character undergoes a transformation due to events in their lives. The main aim of this paper is to share the pain of a woman who undergoes several complications throughout her life and still she has rejuvenated and overpowered all the difficulties faced by her and kept believing that every cloud has a silver lining and have a strong message to be optimistic, calm, and composed because someday or the other difficult times will lead to better days.

**Keywords:** Autobiography, Memoir, Motherhood, Racism, Self-Identity.





**Yashoda Verma**

## INTRODUCTION

And we are put on earth a little space,  
That we may learn to bear the beams of love,  
And these black bodies and this sin burnt face.  
Is but a cloud, and like a shady grove. (W. Blake, The Little Black Boy)

The racial problem between white and black has begun since the slavery period. African American novels comprise of writings of African American writers who have written the history of blacks in the white society from an early period to the present and with the intensity they have expressed their own and other traditions. Black American Literature emerged in the United States which originated through slave narratives. The blacks who were enslaved brought the tradition of believing in folklore mythology in which they pass the knowledge through the mouth which considered tradition, languages, and customs. Oral tradition is a tradition in which black people expressed their African American values through folktales and songs. These folktales and songs contain the stories of the pain of slaves, the fear of enslaved people. In African American Experience: An Historiographical and Bibliographical Guide, Arvah E. Strickland explains that the African oral tradition was the means of communication for the Black folks where they used to sing songs while working in the fields and this tradition became their keyway of transferring their inner emotions of enslavement. After this verbal lore, slave narratives became indispensable in the early eighteenth century. Philips Whitley and Olaudah Equiano created the first cornerstones of African American writing tradition that primarily focused on the issues of slavery.

Black Woman Autobiographies were expanded in the early 1960s as subgenera of Black Autobiography. The Civil Rights and Woman's Movement that emerged in the 1960s also accelerated the black woman's activism. This movement brings an opportunity for black women to express themselves with the help of autobiography and helped to celebrate black womanhood. The black woman started writing and reflected the truth of their life being black women living in white society. This transformation brings a new individual identity and gave meaning to her life and also made an important place in African American Literature that gives the expression of studying black women's lives in depth. Maya Angelou is one of the most influential, prolific, and inspiring black women writers whose works of poetry and non-fiction are studied worldwide and her benefaction to the Civil Rights movements are inestimable. Her celebrated autobiographies are *I Know Why the Caged Birds Sings* (1969), *All God's Children Need Traveling Shoes* (1986), *Gather Together in My Name* (1974), *Singin' and Swigin' and Getting' Merry Like Christmas* (1976), *The Heart of Woman* (1981), and *A Song Flung Up to Heaven* (2002) (Akyampong and Gates231). These autobiographies express the themes of racism, identity, sexuality, and travel. She has worked hard to demonstrate herself in American society and played an important role by conferring so many inspirational works to the bibliomaniac.

The work *Letter to My Daughter* is one of her most notable which is admired emphatically and it has left a positive essence in literature. Maya has dedicated this work to the daughters she never had but perceives all around her, they are Black and White, Jewish and Muslims and speaks copious languages and from every part of the world reveals to them the way of living life with meaning and her intention is to give lesson through her own life (*Letter to My Daughter*). She has gone through a lot of horrible incidents and suffered dreadfully. The biggest sufferings of her life were poverty, abashment, and ravishment but she never allowed herself to be fragile and endeavor a positive message of hope. The protagonist Maya Angelou mirrors the traumatic history of black women and the tyranny of slavery and also narrates her tormented experiences throughout her life. This book is an articulation of motherhood and self-identity but with this, it is a manifestation of trauma that Maya had to suffer in her life. Maya Angelou was born Marguerite Anne Johnson in St. Louis Missouri. After her parent's separation she was sent to her paternal grandmother with her older brother named Bailey Jr. They both lived a happy life with grandmother but after some years her father took them back to their mother in St. Louis. There she had the worst experience of their life as she was raped by her mother's boyfriend Freeman. She unveiled everything to her family about it but with this autobiography, she retrieves "just my breath, carrying my words out, might poison people and they'd curl up and die like the black fat slugs that only pretended (*I Know Why* 87)". This brings a big change in her life as she got





### Yashoda Verma

pregnant and very daringly decided to give birth to the child and it was a transformation of Maya into a new life. Maya didn't spend much time with her mother, when she came to California to live with her mother she found a different environment from her grandmother's house and it was disappointing for her, but still, there was a connection between them, "she made a funny face and against my wishes my I smiled. She kissed me on the lips and started to cry. "That's the first time I have seen you smile. It is a beautiful smile, mother's beautiful daughter can smile". I had never been called beautiful and no one in my memory had ever called me daughter" A person who is experiencing a strenuous situation needs someone to motivate and a harbor to feel safe. Angelou's mother supported and motivated her to overcome the bad memories and helped her in transforming into a new personality that incorporates boldness, maturity, inspiration. After the incident of sexual intimation, the biggest stupefaction was Maya's pregnancy that transformed her into a courageous and responsible woman who decides to give birth to the child. It was too early for her but with the support of her family and especially her mother's incentive, who did her delivery with her hands and powered her, "she put her shoulder against my knee and told me dirty stories. When the pains came, she told me the punch line of the stories and as I laughed, she told me, "Bear down". She gave birth to a baby boy and that moment for her mother was proudest, "she was so proud of her grandson and proud of me. I never had to spend one-minute regretting giving birth to a child who had a devoted family led by a fearless, dotting, and glorious grandmother. So, I became proud of myself (*Letter to My Mother*)".

The very famous *Mother, A Cradle to Hold Me*, a sentimental poem written by Maya Angelou is a blissful read. It is a poem that takes one to a journey of their childhood moments they cherished their mother. She has said that in this materialistic world no one can beat a mother's love. The poem takes us through many emotions of childhood experiences and expressed the importance of motherhood in everyone's life. The survey of race and racism is taken as an important social issue that can be traced to the early part of the twentieth century. Michael Banton's study looked at race relations from a different perspective focusing on affairs of cultural contact, social relations constructed based on racial categories. Throughout the 1960s, Banton's stated that racial relations debatable became the dominant impendent in this field. John Rex's 'Relations in Sociological Theory' represents another attempt to provide a hypothetical framework for the analysis of racism. Rex's work has contributed a major temptation over this field. According to Rex's theory, the definition of social relations between persons as racial relations encouraged by the existence of certain structural conditions such as slavery, harsh class exploitation, occupational segregation, the existence is imprisoned.

The Black American girl who lives in the South, where the society plaudits white beauty, was very much difficult for Maya. She acts as the central character of the novel who expresses the feelings of rejection and segregation. The white people show the feeling of inferiority to her which made her feel ugly, unattractive which affected her psychologically which resulted in Maya comparing herself to white beauty and starting desiring whiteness, fair hair, and blue eyes and feeling ashamed of being an ugly black girl. This belief made Maya lose her identity trying to emulate the techniques white people utter and devour. In *Reclaiming Southern Roots (Letter to My Daughter)*, she explicitly the pain of African Americans whose dreams were broken and didn't have any ray of hope. The black workers were spat out by the system like so many indigestible watermelon seeds. Maya's grandmother is another example of the evil of racism. One day when three white children approached the store, they started laughing at Momma by seeing the gesture that made Angelou full of anger and thought of her uncle's rifle to do harm to her. (*I Know Why*). Segregation for educational, medical, and institutional facilities give blacks no chance for better livings after slavery. The white people are still treated as intelligent and smartest while blacks are still haunted by their discriminative history.

#### Self-Identity

'Socialization' is a term refers to the process of learning norms, customs to live in society. It is an attempt done to attain social and cultural skills that are necessary to survive and participate in the society. George Herbert Mead explained the theory of self to explain the process of individual's social development. He explained that self identity emerges out through social interaction and self image. He claimed that self is not there at birth but emerges through social experiences and it is developed over time in one's life.



**Yashoda Verma**

By the end of her memoir we can see a different Maya Angelou who had suffered a lot but she had learned so many lessons throughout her bad experiences and became a strong, blatant figure who have carried her pregnancy in a very small age, gave birth to a son and with the responsibility she raised him by giving lessons of life. With the help and support of her family she continued her education and started doing job to give all the facilities to her son and accomplished her responsibility being as a mother. The love for literature made her a huge insistence to break the silence and unfair restrictions she lived in, and led her to bring out all her buried capacities and talents. Through her writings she has raised voice against ferocity in 'Violence', which elucidates the rape as a biggest crime. She discusses that many sociologist and social scientists have declared that the act of rape is not a sexual act. But further she explained the horror image of "that make female and male victims unable to open their front doors, unable to venture into streets in which they grew up, unable to trust other human beings and even themselves. Let us call it a violent unredeemable sexual act (*Letter to My Daughter*)". In 'Vulgarity', she reveals against about some personalities who takes coarseness as an art that have bring to the obscenity. Angelou very courageously says that one should not tolerate this because obscenity is not funny and vulgarity is not amusing. Through her writings she has gained name and fame and by sharing her own life experiences she has made a big contribution in Literature and also gained her self-esteemed and identity in her life.

**CONCLUSION**

Maya Angelou's childhood was poor Black girl who had to face racism and segregation in the American society. The discrimination, racism, inferiority by white people brought the traumatic condition and affected her psychologically. However, the positive personalities such as her mother, teacher's, grandmother supported her and with their support and motivation she brought a big change into her life and became one of the most inspiring and blatant woman of the world. The depression is one of the most difficult for everyone to survive, especially for a single black woman in Southern states who cares her son all alone. It was a big challenge for her but her faith in god and hope for good boosted her every time, "whenever I began to question whether God exists, I looked up to the sky and surely there, right there, between the sun and moon" (*Letter to My Daughter*). Hopefully she succeeded to gain her own identity, self consideration and all these achievements were reached because of her determination, faith and love for literature. All her writing gives us so many lessons to learn and to follow in life.

**REFERENCES**

1. Abinaya, R. *Injustice of Racism in Maya Angelou's I Know Why the Caged Bird Sings*. International Journal of Creative Research Thoughts. Vol.5, Issue 4, 2017.
2. Angelou, Maya. *Letter to My Daughter*. Random House, 2009.
3. Blake, William. *The Little Black Boy*. 1789.
4. Gardy, Marilyn. *Maya Angelou's Letter to My Daughter*. Journal of Women in Educational Leadership. 2008
5. Gogoi, Pallavi. *The Autobiographies of Maya Angelou: Critical Perspectives on Crime and Deviance*. 2018.
6. Mustavi, Zahra. Suwargono. Eko & Pujiati. Hat. Racial Discrimination as the Representation of American Social Life in 1970s in Maya Angelou's Selected Poems, UNEJ PRESS, 2015.
7. Prabhavathy. P. & Dr. Sowmiya. A. MS. *The Pilot Study of Maya Angelou's Novels 'I Know Why the Caged Bird Sings' and 'The Heart of a Woman'*. Pune Research. Vol.4. Issue 5, 2018.
8. Solomos, John & Back. Les. *Theories of Race and Racism*. Routledge, 2009.







## Morphological Characterisation and Pathogenicity of *Fusarium* sp., the Causal Agent of *Fusarium* Wilt of Chilli from Major Chilli Growing Districts of Andhra Pradesh and Tamil Nadu

N.H. Sankara Reddy<sup>1\*</sup> and K. Rajamohan<sup>2</sup>

<sup>1</sup>Ph.D Research Scholar, Department of Plant Pathology, Faculty of Agriculture, Annamalai University, Annamalai Nagar - 608002, Chidambaram, Tamil Nadu, India.

<sup>2</sup>Assistant Professor, Department of Plant Pathology, Faculty of Agriculture, Annamalai University, Annamalai Nagar - 608002, Chidambaram, Tamil Nadu, India.

Received: 24 Nov 2021

Revised: 19 Dec 2021

Accepted: 12 Jan 2022

### \*Address for Correspondence

**N.H. Sankara Reddy**

Ph.D Research Scholar,

Department of Plant Pathology,

Faculty of Agriculture, Annamalai University,

Annamalai Nagar - 608002,

Chidambaram, Tamil Nadu, India.

Email: shankarr993@gmail.com



This is an Open Access Journal / article distributed under the terms of the **Creative Commons Attribution License** (CC BY-NC-ND 3.0) which permits unrestricted use, distribution, and reproduction in any medium, provided the original work is properly cited. All rights reserved.

### ABSTRACT

Chilli (*Capsicum annuum* L.) is one of the important spices and aromatic vegetable crop cultivating all over the world. *Fusarium* wilt of chilli incited by *Fusarium* sp. is a one of the major threats to chilli growing farmers in major chilli growing areas in India. In severe cases the yield loss goes up to 80-100 %. A survey was conducted in major chilli growing areas of Andhra Pradesh and Tamil Nadu to study *Fusarium* wilt of chilli incidence. The overall severity of disease incidence from the lowest to highest ranges 6.85-38.96 from Karambilipatti (F13) and Peesapadu (F1) villages respectively. The pathogen was characterised morphologically (mycelial characters, production of microconidia, macroconidia and chlamydospores) and pathogenicity test was performed to observe the virulence of the pathogen. The objective of this research is to characterise *Fusarium* sp. and observe the morphology and virulence of pathogen.

**Keywords:** Chilli, *Fusarium* wilt, *Fusarium* sp., Morphological characters, Virulence

### INTRODUCTION

Chilli (*Capsicum annuum* L.) is one of the important spices and aromatic vegetable crop grown all over the world, it belonging to the family *Solanaceae*, it is called with different names hot pepper, sweet pepper, chili pepper, cayenne pepper and bell pepper etc. (16) having superfluous nutritional and medicinal value (10,11). There are more than 400

38308



**Sankara Reddy and Rajamohan**

different varieties of chillies found all over the world. The center of diversity of chili is considered to be in south-central South America (7). India is popularly known as “spice bowl of the world” and is the world's largest producer, consumer and exporter of chillies (1) has the largest area of 7.33 lakh ha (18.11 lakh acres) with a production of 17.64 lakh tonnes accounting for 42.81% of world area, followed by China, Ethiopia, Thailand and Pakistan in 2018-19. Chilli is often affected various fungal, bacterial and viral diseases. *Fusarium* wilt of chilli is caused by *Fusarium* sp. an economic soil borne fungal pathogen causes huge economic losses (12). The yield losses range from 10-50 % in the world and 10-80 % in India (17). *Fusarium* wilt is characterised by yellowing and wilting of the plant and upward and inward rolling of the leaves. The younger leaves may die in succession and the entire may wilt and die in a course of few days. Disease symptoms are characterised by an initial slight yellowing of the foliage and wilting of the upper leaves that progress in a few days into a permanent wilt with the leaves still attached. By the time above ground symptoms are evident, the vascular system of the plant is discoloured, particularly in the lower stem and roots.

## MATERIALS AND METHODS

### Survey and incidence of *Fusarium* wilt of chilli from different district of Andhra Pradesh and Tamil Nadu

Survey is conducted in major chilli growing districts of Andhra Pradesh (Guntur, Kadapa) and Tamil Nadu (Cuddalore, Trichy and Dindugal) during rabi season, march 2021 (Table 1). Samples are collected from different village of Andhra Pradesh and Tamil Nadu. A random sampling has been done and diseased samples are collected by selecting different plots from each village and assessed the disease incidence Percent disease incidence (PDI) was calculated by using the following formula

$$\text{PDI} = \frac{\text{Number of plants observed}}{\text{Total number of plants}} \times 100$$

### Isolation and Identification of *Fusarium* wilt of chilli pathogen

Diseased chilli plants with severe wilting symptoms were collected. *Fusarium* pathogen was confined to vascular bundles, so brown colour vascular bundles were selected for isolation of pathogen. The infected vascular bundle stem portion was cut into small pieces along with healthy portions. The bits was cut into small pieces of 3-5 mm slices and surface sterilized with 1% sodium hypochlorite ( $\text{Na}_2\text{OCl}$ ) for 30sec-1 min, rinsed through 3 variants of sterile water and dried with tissue paper, and 2-4 bits were placed in a Petri Plate containing solidified agar medium supplemented with streptomycin sulphate to prevent bacterial contamination. The culture are incubated at  $28 \pm 2^\circ\text{C}$  for 3-5 days. After developing fungal colonies a small bit of fungal mycelium is transferred into fresh plate containing PDA medium for 5-7 days to have pure culture. The pure cultures of the pathogen were maintained in PDA slants for further studies. The cultural and morphological characters of the isolates were also studied.

### Inoculum preparation

The spore suspensions were prepared from 7-10 days old isolates cultured on the PDA at room temperature. The roots of seedlings were trimmed with a sterile scissor and submerged into tubes containing 30 ml of *F. oxysporum* and *F. solani* spore suspensions ( $1 \times 10^6$  spore ml<sup>-1</sup>) for 30 mins. And the inoculated seedlings were transplanted into mini pots, 15 cm diameter, surface sterilized with 0.1% mercuric chloride (5), containing soil and sand at 1:1 ratio and incubated in a growth chamber. Inoculated and non-inoculated (control) pepper seedlings were incubated at  $22^\circ\text{C}$ . The control plants were treated with 30 ml sterile distilled water.

### Assessing the virulence of *Fusarium* sp. isolates (Pathogenicity Test)

Pathogenicity test was carried out using a root dip inoculation method by inoculating the chilli plant with inoculum (8, 10). 20-30 days old seedlings of chilli were uprooted gently from the soil. The roots were rinsed in water, soaked in 1% chlorox solution for 1 minute, rinsed with sterile water, and then soaked in fungal suspension for 30 minutes (6). The roots of seedlings were dipped in a fungal spore suspension of *Fusarium* sp broth containing  $10^6$  spores per



**Sankara Reddy and Rajamohan**

ml for 5 min (17) and then dried on a tissue paper. Roots of healthy plants without treatment of fungal spore suspension were served as control. Two seedlings were transplanted into each pots containing sterilized soil mixed with equal proportions of sand, clay loam soil and farm yard manure at the ratio of 1:1:1 respectively. Plants were irrigated regularly.

**RESULTS AND DISCUSSION****Survey and incidence of *Fusarium* wilt of chilli from different district of Andhra Pradesh and Tamil Nadu**

A field survey has been carried out in major chilli growing areas of Andhra Pradesh and Tamil Nadu and measured the disease incidence of fusarium wilt of chilli and the data were furnished in table 1. The disease incidence was recorded on different chilli varieties viz., Teja, endo 5 and local variety in major growing areas. The fusarium wilt ranged from 6.85 to 38.96 per cent. Among the surveyed localities, Peesapadu (F1) village registered maximum disease incidence of 39.03 percent followed by Karambilipatti (F13) village recorded 35.57 percent disease incidence and the least disease incidence of 6.85 was recorded in Athicombai (F18). Wani *et al* (2) reported *Fusarium* wilt disease can occur in nursery during transplantation but the maximum wilt incidence can be noticed during flowering/ fruiting stage, based on field survey in five major vegetables growing areas of districts Anantnag and Kulgam of Kashmir valley (temperate region of India). Thoyajakshi Bai *et al.*, 2018 (17) investigated incidence of fusarium wilt of chilli from 27 locations of Andhra Pradesh and recorded the percent disease incidence varied from 0-40 % and also observed the occurrence of high fusarium wilt incidence during November – December months. Raghu *et al* (14) carried out a random roving survey during 2012-2014 in major chilli growing areas of south India, (Karnataka, Andhra Pradesh and Maharashtra) and assessed the disease incidence, severity, loss and genotypes affected.

**Morphological variability of different *Fusarium* sp. isolate****Mycelial characters**

The morphological variability among the twenty isolates of *Fusarium* sp. was studied and observed for the variation in colony characteristics as white fluffy raised cottony mycelium, cream white mycelium, cream white submerged cotton mycelium and pale brown white cottony mycelium were represented in table 2. Among the twenty different isolates, F1 showed white fluffy raised cottony mycelium with maximum mycelial growth of 85.67mm (7 days), whereas least mycelial growth of 23.67mm (7 days) was observed in the isolate of F18. Chandran and Kumar (3) while studying variability of *F. solani* isolates found six isolates as white sparse growth, three as white cottony growth, two as white fluffy and three as white dense growths. Similar types of results were also made by earlier workers (18,4). Monoj Gogoi *et al* (13) studied cultural and morphological characters of eight isolates of *F. solani* from patchouli growing areas of Assam and measured the colony diameter, radial growth of eight isolates. The colony diameter of eight isolates ranged from 81.55 mm to 90.00 mm at ten days after inoculation on PDA medium. The fastest radial growth (90.00 mm) was observed in isolates JFS1, JFS2 and NFS4 followed by isolates GFS8 (87.56 mm), BFS6 (87.46 mm), NFS3 (85.34 mm) and NFS5 (84.78 mm) whereas minimum radial growth was observed in isolate BFS7 (81.88 mm).

**Conidial characters****Microconidia, macroconidia and chlamydo spores**

Production of microconidia, macroconidia and chlamydo spores of 20 isolates are recorded and represented in table 2. The size of microconidia ranges from 13.89-26.91µm length to 3.45-7.32 µm breadth, size of macroconidia ranges from 38.86-65.40µm length to 4.98-7.45µm, chlamydo spores diameter ranges from 9.80-12.01, the number of septa of micro and macroconidia are 0-1 and 2-6 respectively. All conidia are sickle to crescent shaped with blunt ends and chlamydo spore are produced terminal to intercalary with round to oval shaped. Monuj Gogoi *et al* (13) measured the size and characters of micro, macro-conidia and chlamydo spores eight isolates of *F. solani*. The size of macro conidia was ranged from 13-15 x 3-4 µm to 27-29 x 4-5 µm, size of micro conidia was ranged from 3-4 x 1-2 µm to 9-10 x 1-3



**Sankara Reddy and Rajamohan**

µm, the number of septa in macro and micro conidia are 2-4 and 0-1 respectively. All conidia were hyaline and produced sickle shaped macro-conidia with blunt end, cylindrical and round to oval shaped micro-conidia and chlamydospore were intercalary, terminal, globose to oval shaped in all the isolates.

**Pathogenicity of *Fusarium* sp. isolates under pot culture condition**

All the twenty isolates of *Fusarium* sp. were tested to evaluate the ability to cause disease in chilli under pot culture experiment. The results are furnished in the table 3., showed that the virulence varied significantly among the isolates. Among the different isolates, the isolate F1 collected from Peesapadu village reported the maximum disease incidence of 42.23 per cent and was identified as virulent isolate followed by F13 which recorded 40.40 per cent from Karambipatti village. The isolate F18 collected from Athicombai village was the least virulent isolate which recorded the least fusarium wilt incidence of 14.53 per cent. The results are co-inside with Thoyajakshi Bai *et al* (17), performed pathogenicity test pot culture by using root dip inoculation method. Seedlings of chilli were uprooted gently from the nursery. The roots of seedlings were dipped in a spore suspension of *F. oxysporum* broth containing 10<sup>6</sup> spores per ml for 5 min, dried briefly on a tissue paper and then two seedlings were transplanted into the pots. Four replications were maintained, plants were irrigated regularly. The disease incidence was calculated twenty days after transplanting. S. Raghu *et al* (15) carried out pathogenicity test on 36 isolates of *Fusarium* spp. was conducted on three popular chilli varieties viz. Sitara, Byadgikaddi and Byadgidabbi under artificially inoculated condition under glasshouse condition. The isolates were multiplied in using sand corn media. The twenty day old giant culture was used to inoculate into sterilized soil at @10w/w. the surface sterilized seeds of three varieties of chilli were sown @20seeds/pot with two replications. The pots were maintained with optimum moisture at field capacity by watering regularly. The final observations like germination percentage, Pre-emergent and postemergent seedling death and percent disease incidence was calculated.

**CONCLUSION**

The fusarium wilt of chilli incidence revealed significant variations from chilli growing areas of Andhra Pradesh and Tamil Nadu. The disease incidence was higher in monocropping areas, it's always better to practice crop rotation with non-host crops in order to reduce the magnitude of disease. Among the various isolates tested, Peesapadu (F1) is virulent *in vitro* and *in vivo* (pot culture) conditions, the environmental conditions, continuous monocropping and amount of inoculum favouring the range of severity. The cultural and morphological variations is due to presence of different strains, races and biotypes of the pathogen. The major drawback with these kinds of studies is that the virulence of the isolates changes from area to area and also from one variety of crop to another. Molecular studies have to be carried out to observe the molecular variability among the virulent and non-virulent isolates of the pathogen.

**REFERENCES**

1. Anonymous, 2016. Indian Horticulture Database. National Horticulture Board, Ministry of Agriculture, Government of India. (cf. [http://nhb.gov.in/area-pro/IndianHorticulture Database](http://nhb.gov.in/area-pro/IndianHorticultureDatabase)).
2. Baba ZA, Padder SA, Bhat MA, Wani SA, Mohiddin FA, Hamid B, Rizvi G, Bhat KA, Hamid A and Alam A, 2014. Incidence of Fusarium wilt of chilli (*Capsicum annum* L.) in Kashmir valley and its management by *Trichoderma* spp. *Mycopath*, 12(1).
3. Chandran MR and Kumar MR, 2012. Studies on cultural, morphological variability in isolates of *Fusarium solani* (Mart.) Sacc, incitant of dry root-rot of Citrus. *Curr. Biotica*. 6(2): 152-162.
4. Chavan SC, Hegde YR and Prashanthi SK. 2009. Management of wilt of patchouli caused by *Fusarium solani*. *J. Mycol. Pl.*
5. Dubey SC, Singh SR, 2008. Virulence analysis and oligonucleotide fingerprinting to detect genetic diversity among Indian isolates of *Fusarium oxysporum* f. sp. *ciceris* causing chickpea wilt. *Mycopathologia*, 165(6): 389-406.
6. Feriniah RS, Daryono BS, Kasiandari RS and Priyatmojo A, 2014. Characterization and pathogenicity of *Fusarium oxysporum* as the causal agent of Fusarium wilt in chili (*Capsicum annum* L.). *Microbiology Indonesia*. 8(3), pp.5-5.





**Sankara Reddy and Rajamohan**

7. Gonzalez M and Bosland P, 1991. Strategies for stemming genetic erosion of Capsicum germplasm in the Americas. Diversity, 7(1-2): 52-53.
8. Herman R and PerI-Treves R, 2007. Characterization and inheritance of a new source of resistance to *Fusarium oxysporum* f. sp. *melonis* Race 1.2 in Cucumis melo. Plant Disease, 91(9): 1180-1186.
9. Hunziker AT, 2001. Genera Solanacearum. The Genera of Solanaceae Illustrated, Arranged According to a New System Gantner Verlag, Ruggell, Liechtenstein, pp: 516.
10. Karimi R, Owuochi JO, Silim SN, 2010. Inheritance of Fusarium wilt resistance in pigeonpea [*Cajanus cajan* (L.) Millspaugh]. Indian Journal of Genetics and Plant Breeding, 70(3): 271-276.
11. Knapp S, Bohs L, Nee M and Spooner DM, 2004. Solanaceae a model for linking genomics with biodiversity, Com FuncGenom, 5(3): 285-291.
12. Madhavi M, Pramod Chandra Kumar C, Raja Ram Reddy D and Singh TVS, 2006. Integrated Management of Wilt of Chilli incited by *Fusarium Solani*. Indian Journal of Plant Protection, 34 (2), pp225-228.
13. Monuj Gogoi DK, Sarmah and Ali S, 2017. Cultural and Morphological Variations of *Fusarium solani* (Mart.) Sacc. Causing Root Rot of Patchouli in Assam. Int.J.Curr.Microbiol.App.Sci. 6(11): 1889-1901.
14. Raghu S, Benagi VI and Nargund VB. Cultural, morphological and pathogenic variability among the isolates of *Fusarium solani* causing wilt disease of chilli. Int. J. of Agri. Sci. and Res. 2017; 4:6 96-105.
15. Raghu S, Benagi VI and Nargund VB, 2016. Cultural, morphological and pathogenic variability among the isolates of *Fusarium solani* causing wilt disease of Chilli (*Capsicum annum* L.). *Journal of Pure and Applied Microbiology, Shahjahanabad*, 10(1), pp.599-604
16. Sahi IY and Khalid AN, 2007. In vitro biological control of *Fusarium oxysporum*, causing wilt in *Capsicum annum*. Mycopath, 5: 85-88.
17. Thoyajakshi Bai A, Ch. Ruth, Gopal K, Arunodhayam K, Tanuja Priya B and Ramakrishna M, 2018. Survey and Identification of *Fusarium* Wilt Disease in Chilli (*Capsicum annum* L.). Int.J.Curr.Microbiol.App.Sci. 7(06):1073-1078.
18. Vettraino AM, Shresha GP and Vannini A, 2009. First report of *Fusarium solani* wilt of *Olea europaea* in Nepal. Plant Dis. 93: 200.

**Table 1. Survey and incidence of *Fusarium* wilt of chili from major chilli growing areas of Andhra Pradesh and Tamil Nadu**

S.NO	Isolate	Area	District	Variety	Soil type	Coordinates		<i>Fusarium</i> wilt incidence (%)
1	F1	Peesapadu	Guntur	Teja	Red soil	16°28'56" N	80°08'23" E	38.96 <sup>a</sup> (38.61)
2	F2	Kattamuru	Guntur	Teja	Red soil	16°29'31" N	80°08'58" E	23.15 <sup>g</sup> (28.75)
3	F3	Kattamuru	Guntur	Teja	Red soil	16°28'56" N	80°10'57" E	25.76 <sup>f</sup> (30.49)
4	F4	Andukuru	Guntur	Teja	Red soil	16°31'13" N	80°11'1" E	31.16 <sup>cd</sup> (33.93)
5	F5	Gaarapadu	Guntur	Teja	Red soil	16°30'42" N	80°13'11" E	18.65 <sup>h</sup> (25.58)
6	F6	Phanidham	Guntur	Teja	Red soil	16°45'85" N	80°17'71" E	30.33 <sup>de</sup> (33.41)
7	F7	Abburu	Guntur	Teja	Red soil	16°44'24" N	80°16'24" E	34.76 <sup>b</sup> (36.12)
8	F8	Thorrivemala	Kadapa	Endo 5	Clay loam	14°53'43.5" N	78°19'14.9" E	13.66 <sup>i</sup> (21.68)
9	F9	Ponnampalle	Kadapa	Endo 5	Clay loam	14°54'44.3" N	78°18'28" E	32.11 <sup>c</sup> (34.51)
10	F10	Dugganapalli	Kadapa	Endo 5	Clay loam	14°56'5.7" N	78°19'42.6" E	28.98 <sup>e</sup> (32.56)
11	F11	Sivapuri	Cuddalore	Local	Red soil	11°22'00.1" N	79°42'51.0" E	22.86 <sup>g</sup> (28.56)
12	F12	Kuduraikuthipatty	Trichy	Local	Clay loam	10°38'24.5" N	78°24'45.2" E	12.10 <sup>j</sup> (20.35)
13	F13	Karambilipatti	Trichy	Local	Red soil	10°40'11.4" N	78°25'17.6" E	35.57 <sup>b</sup> (36.61)
14	F14	Kottapatti	Trichy	Local	Red soil	10°39'52" N	78°24'57" E	26.90 <sup>f</sup> (31.23)
15	F15	Aamayapuram	Trichy	Local	Red loam	10°38'43.6" N	78°24'36.6" E	10.89 <sup>kl</sup> (19.26)
16	F16	Nalupulikottai	Dindigul	Local	Black soil	10°28'3" N	77°49'49" E	12.89 <sup>j</sup> (21.03)
17	F17	Puducharam	Dindigul	Local	Black soil	10°28'53.3" N	77°47'22.4" E	9.86 <sup>kl</sup> (18.30)





## Sankara Reddy and Rajamohan

18	F18	Athicombai	Dindigul	Local	Black soil	10°29'05.4" N	77°46'31.4" E	6.85 <sup>m</sup> (15.17)
19	F19	Naganampatty	Dindigul	Local	Black soil	10°20'03.9" N	77°45'34.9" E	11.16 <sup>k</sup> (19.51)
20	F20	Kalanjipatty	Dindigul	Local	Black soil	10°30'40.8" N	77°46'53.7" E	9.45 <sup>l</sup> (17.90)

Mean of three replications  
Values in the column followed by common letters do not differ significantly at 5% level by Duncan's multiple range test (DMRT)

**Table 2. Morphological variability of *Fusarium* wilt of chilli from different localities of Andhra Pradesh and Tamil Nadu**

solate	Locality	Colony characters	Mycelial growth (7 days)	Micro conidia			Macro conidia			Chlamyospore Diameter (µm)
				Length (µm)	Width (µm)	No. of septations	Length (µm)	Width (µm)	No. of septations	
F1	Peesapadu	White fluffy raised cottony mycelium	85.67 <sup>a</sup> (67.74)	18.85	5.15	0-1	44.03	6.03	4-6	11.85
F2	Kattamuru	Cream white mycelium	57.32 <sup>f</sup> (49.20)	13.67	3.67	0-1	45.65	6.03	2-3	10.45
F3	Kattamuru	White cottony mycelium	60.44 <sup>e</sup> (51.02)	18.15	3.45	0-1	50.56	5.89	2-4	10.05
F4	Andukuru	White cottony mycelium	68.60 <sup>c</sup> (55.91)	26.91	6.32	0-1	40.60	7.50	3-5	10.00
F5	Gaarapadu	White cottony mycelium	51.67 <sup>h</sup> (45.95)	15.25	4.54	0-1	48.68	7.45	2-4	11.5
F6	Phanidham	Cream white submerged cotton mycelium	68.10 <sup>c</sup> (55.60)	22.21	7.32	0-1	45.47	7.07	3-5	10.5
F7	Abburu	Cream white fluffy mycelium	71.16 <sup>b</sup> (57.52)	20.86	5.86	0-1	65.40	6.82	3-5	12.01
F8	Thorrivemala	White fluffy cottony mycelium	44.06 <sup>i</sup> (41.58)	15.67	4.97	0-1	59.97	6.05	2-4	9.5
F9	Ponnampalle	White cottony mycelium	70.05 <sup>bc</sup> (56.81)	18.34	4.44	0-1	52.13	8.05	3-5	9.95
F10	Dugganapalli	White fluffy cottony mycelium	64.15 <sup>d</sup> (53.21)	19.56	4.23	0-1	54.76	6.88	2-5	10.8
F11	Sivapuri	Pale brown to white cottony mycelium	55.01 <sup>g</sup> (47.86)	18.56	4.01	0-1	56.46	6.67	2-4	10.4
F12	Kudurai kuthipatty	Cream white mycelium	42.11 <sup>i</sup> (40.45)	17.25	4.67	0-1	54.26	6.06	2-5	10.35
F13	Karambilipatti	Cream white to pinkish mycelium	73.65 <sup>a</sup> (69.10)	24.87	5.79	0-1	40.09	6.29	2-5	10.86
F14	Kottapatti	White creamy to white greyish mycelium	62.66 <sup>d</sup> (52.32)	14.67	4.37	0-1	44.87	5.88	2-5	10.56
F15	Aamayapuram	Pale brown to dark brown zonation	36.89 <sup>j</sup> (37.39)	16.67	4.09	0-1	47.98	6.62	2-4	11.08
F16	Nalupulikottai	Whitish brown fluffy mycelium	43.63 <sup>i</sup> (41.33)	17.54	4.56	0-1	56.39	5.77	2-4	9.85
F17	Puducharam	Milkfish white cottony mycelium	32.23 <sup>k</sup> (34.58)	16.67	3.67	0-1	39.84	5.57	2-3	10.5
F18	Athicombai	Pale brown cottony mycelium	23.67 <sup>m</sup> (29.11)	13.89	3.76	0-1	38.86	5.51	2-3	9.80
F19	Naganampatty	Brownish mycelium	38.66 <sup>j</sup> (38.44)	15.56	3.98	0-1	43.67	6.18	2-3	10.15
F20	Kalanjipatty	Creamy white fluffy mycelium	29.56 <sup>l</sup> (32.92)	16.91	4.03	0-1	42.10	4.98	2-3	9.85





## Sankara Reddy and Rajamohan

Table 3. Pathogenicity of *Fusarium* sp. under pot culture conditions

S.NO	Isolates	<i>Fusarium</i> wilt incidence (%)				Mean
		60 DAT	90 DAT	120 DAT	During harvest (150 days)	
1	F1	30.34 <sup>a</sup> (33.42)	37.88 <sup>a</sup> (37.98)	46.15 <sup>a</sup> (42.78)	54.55 <sup>a</sup> (47.60)	42.23
2	F2	19.15 <sup>hij</sup> (25.95)	24.19 <sup>fg</sup> (29.45)	31.88 <sup>gh</sup> (34.37)	40.89 <sup>hi</sup> (39.79)	29.03
3	F3	19.89 <sup>ghi</sup> (26.48)	24.66 <sup>efg</sup> (29.76)	32.60 <sup>fg</sup> (34.81)	41.11 <sup>hi</sup> (39.87)	29.56
4	F4	23.11 <sup>e</sup> (28.73)	29.45 <sup>c</sup> (32.86)	37.38 <sup>cd</sup> (37.68)	47.16 <sup>de</sup> (43.36)	23.27
5	F5	18.05 <sup>jk</sup> (25.13)	23.01 <sup>gh</sup> (28.65)	29.67 <sup>i</sup> (33.00)	38.05 <sup>jk</sup> (38.08)	27.19
6	F6	22.11 <sup>ef</sup> (28.04)	27.67 <sup>d</sup> (31.73)	35.76 <sup>de</sup> (36.71)	45.51 <sup>ef</sup> (42.42)	36.76
7	F7	27.01 <sup>e</sup> (31.31)	31.08 <sup>c</sup> (33.87)	41.98 <sup>d</sup> (40.38)	50.78 <sup>bc</sup> (45.44)	37.71
8	F8	17.75 <sup>kl</sup> (24.91)	22.46 <sup>h</sup> (28.28)	28.56 <sup>j</sup> (32.30)	37.57 <sup>jk</sup> (37.79)	26.58
9	F9	24.89 <sup>d</sup> (29.92)	30.13 <sup>c</sup> (33.29)	38.67 <sup>c</sup> (38.44)	48.66 <sup>cd</sup> (44.22)	35.59
10	F10	21.01 <sup>fg</sup> (27.27)	26.08 <sup>de</sup> (30.70)	34.65 <sup>ef</sup> (36.05)	44.11 <sup>fg</sup> (41.61)	31.46
11	F11	18.76 <sup>ijk</sup> (25.66)	23.23 <sup>gh</sup> (28.80)	30.14 <sup>hi</sup> (33.29)	38.96 <sup>ij</sup> (38.61)	27.77
12	F12	14.58 <sup>m</sup> (22.44)	19.74 <sup>i</sup> (26.37)	25.38 <sup>kl</sup> (30.24)	35.34 <sup>kl</sup> (36.46)	23.76
13	F13	28.67 <sup>b</sup> (32.37)	35.67 <sup>b</sup> (36.66)	44.66 <sup>a</sup> (41.92)	52.59 <sup>ab</sup> (46.97)	40.40
14	F14	20.11 <sup>gh</sup> (26.64)	25.76 <sup>ef</sup> (30.49)	33.10 <sup>fg</sup> (35.12)	42.68 <sup>gh</sup> (40.78)	30.41
15	F15	12.18 <sup>n</sup> (20.42)	17.67 <sup>j</sup> (24.85)	23.43 <sup>lm</sup> (28.94)	31.05 <sup>m</sup> (33.86)	21.08
16	F16	16.67 <sup>l</sup> (24.09)	21.67 <sup>h</sup> (27.74)	26.66 <sup>jk</sup> (31.08)	36.56 <sup>kl</sup> (37.20)	25.39
17	F17	10.78 <sup>op</sup> (19.16)	15.65 <sup>k</sup> (23.30)	21.72 <sup>mn</sup> (27.77)	28.64 <sup>nop</sup> (32.35)	19.20
18	F18	7.65 <sup>r</sup> (16.05)	12.32 <sup>l</sup> (20.54)	16.87 <sup>op</sup> (24.24)	21.83 <sup>q</sup> (27.85)	14.53
19	F19	13.20 <sup>n</sup> (21.30)	18.59 <sup>ij</sup> (25.53)	24.15 <sup>i</sup> (29.43)	34.23 <sup>i</sup> (35.80)	22.54
20	F20	9.66 <sup>q</sup> (18.10)	13.56 <sup>l</sup> (21.60)	19.78 <sup>n</sup> (26.40)	24.56 <sup>opq</sup> (29.70)	16.89

Mean of three replications

Values in the column followed by common letters do not differ significantly at 5% level by Duncan's multiple range test (DMRT)





## Studies on the Differential Gene Expression of Terpenoid Biosynthesis Pathway from Wild *Cymbopogon martinii* (Roxb.)

Ashwini M<sup>1</sup>, Sree Latha K<sup>1</sup> and Tharasaraswathi K J<sup>2\*</sup>

<sup>1</sup>Research Scholar, Department of Microbiology and Biotechnology, Jnana Bharathi Campus, Bangalore University, Bangalore, Karnataka, India.

<sup>2</sup>Professor, Department of Microbiology and Biotechnology, Jnana Bharathi Campus, Bangalore University, Bangalore, Karnataka, India.

Received: 23 Dec 2021

Revised: 04 Jan 2022

Accepted: 19 Jan 2022

### \*Address for Correspondence

#### Tharasaraswathi K J

Professor, Department of Microbiology and Biotechnology,  
Jnana Bharathi Campus,  
Bangalore University,  
Bangalore, Karnataka, India.  
Email: tharasaraswathi@bub.ernet.in



This is an Open Access Journal / article distributed under the terms of the **Creative Commons Attribution License** (CC BY-NC-ND 3.0) which permits unrestricted use, distribution, and reproduction in any medium, provided the original work is properly cited. All rights reserved.

### ABSTRACT

*Cymbopogon martinii* (Roxb.) W. Watson commonly referred as Palmarosa or Rosha grass (Poaceae) show variation in the variety of terpenoid compounds. In this terpenoid group monoterpenes and sesquiterpenes represent as major compounds in essential oils of *Cymbopogon* species. The understanding of the molecular mechanism convoluted in terpenoid biosynthesis is essential for refining the yield and quality of terpenes by means of high-throughput transcriptome sequencing. In the current study transcriptome data, of leaf and inflorescence of *Cymbopogon martinii* (Roxb.)W. Watson explored from wild location (Devarayana Durga hill, Tumkur, Karnataka) were undertaken and can be subjected to generate large magnitudes of transcript sequences for discovering the genes involved in terpenoid biosynthesis. Based on the transcriptome data seven unigenes viz., Geranyl diphosphate synthase (GPPS), Farnesyl Diphosphate synthase (FPPS), Alcohol dehydrogenase (ADH), Terpene synthase (TPS), Geraniol synthase (GES), Linalool synthase (LS), and Beta-selinene synthase (BSS) convoluted in terpenoid biosynthesis were selected. These genes were further exposed to qRT-PCR studies for differential gene expression investigation. The outcomes revealed a different level of expression patterns of the selected seven unigene associated to terpenoid biosynthesis which was in correlation with the transcriptome data.

**Keywords:** Wild *Cymbopogon martinii*, Gene expression studies, qRT-PCR, Terpenoid pathway





**Ashwini et al.,**

## INTRODUCTION

*Cymbopogon martinii* (Roxb.) W. Watson is a perennial scented plant cultivated for its commercial importance of essential oil production for its rose-like aroma, commonly referred as Palmarosa or Roshagrass. The plant belongs to Poaceae family and is local to India (Verma et al., 2010) with a chromosome number of  $2n = 20$  and  $2n=40$  (Sreenath and Jagadish chandra, 1988; Rajeswara Rao et al., 2015). It majorly grows in forests of the tropics and subtropical areas of the world, consisting of Indonesia, Madagascar, Paraguay, and Brazil (Sahu et al., 2000; Sangwan et al., 2001; Verma et al., 2010). In India, palmarosa propagates extremely in Andhra Pradesh, Madhya Pradesh, Karnataka, Maharashtra, Odisha, and Uttar Pradesh. The leaf and floral shoots are the main resources of Palmarosa oil. The oil has significant use in the production of soap, perfumery, and cosmetics (Verma et al., 2010). The essential oil of Palmarosa has antifungal (Kalagatur et al., 2018), antibacterial (MurbachTeles Andrade et al., 2018), anthelmintic (Katiki et al., 2011), antiseptic (Rao et al., 1996), and mosquito repellent (Das and Ansari, 2003) properties.

The terpenoids (also known as isoprenoids) are the primary components of aromatic oil and are synthesized from the condensation of 1 molecule of Dimethylallyl pyrophosphate (DMAPP) and one or more molecules of Isopentenyl pyrophosphate (IPP) to provide geranyl diphosphate (GPP), farnesyl diphosphate (FPP), or geranylgeranyl diphosphate (GGPP) (Gershenzon and Croteau 1993) and all varied terpenes are derivative of those 3 pioneers. IPP is mainly biosynthesized from two separate pathways (i) cytosolic acetate-MVA (Ganjewala and Luthra, 2007a, b; Dubey and Luthra, 2001) and (ii) plastidial 2C-methyl-D-erythritol-four-phosphate (MEP) (Ganjewala et al., 2009; Gupta and Ganjewala, 2015a). The enzymes which use these GPP, FPP, or GGPP as substrates are known as Terpene synthases and the product formed is a cyclic compound termed as Terpene cyclase.

Terpene synthases are vital for the biosynthesis of terpenoids, they catalyze ionization of the prenyldiphosphate to produce a carbocation intermediate, which then go through intermolecular reorganization or nucleophilic changes as guided by the enzyme (Christianson,2008) Terpenes encompass chemically diverse classes of compounds synthesized by the plants. They are involved in a number of biological activities such as hormones, mediators of polysaccharide synthesis, photosynthetic pigments, electron carriers, and membrane components, among other essential purposes within the plant (Chappell 1995; McGarvey and Croteau 1995). They also intermediate communication between plants and their environment.

The differential expression levels of terpenoid pathway genes positively associated with the total terpenoid content representing these genes can play an important regulatory role in terpenoid biosynthesis. We attempted to confirm the relationship between the transcript level of selected terpenoid synthase genes and the accumulation of various constituents of associated terpenoids in selected tissues of wild *Cymbopogon martinii* (Roxb.) W.Watson.

## MATERIALS AND METHODS

### Wild plant collection and identification

*Cymbopogon martinii* (Roxb.) W. Watson flora were collected from Devarayana Durga hill, Tumkur Karnataka, India with field conditions (average humidity 60% and temperature  $25 \text{ }^\circ\text{C} \pm 2 \text{ }^\circ\text{C}$ ). The leaf and inflorescence samples were separately harvested during the flowering season (October) which is suggested to be the biogenetically active period for essential oil biosynthesis and accumulation. The leaf and inflorescence samples were collected and instantly frozen in liquid nitrogen and stored at  $-80 \text{ }^\circ\text{C}$ . The wild genotype of *C. martinii* collected was subjected to identification and authentication.



**Ashwini et al.,****Quantitative real-time PCR (qRT-PCR) analysis**

For qRT-PCR studies, seven unigenes were selected namely- Geranyl Diphosphate synthase (GPPS), Farnesyl Diphosphate synthase (FDPS), Alcohol dehydrogenases (ADHs), Terpene synthase (TPS), Geraniol synthase (GES), Linalool synthase (LS), and  $\beta$ -selinene synthase(BSS) related to terpenoid pathway which is likely involved in essential oil biosynthesis. The produced transcriptome data of presently studied wild *Cymbopogon martini* (Roxb.) W. Watson was submitted to NCBI-SRA.

**RNA extraction and cDNA synthesis**

Total RNA was extracted from leaf and inflorescence using RNA isolation Kit (Trizol method) and 1  $\mu$ g of RNA was used for cDNA synthesis. Primers for GPPS, FDPS, ADHs, TPS, GES, LS, and BSS were retrieved from literature and synthesized. The PCR reaction was set up for cDNA synthesis: the reaction mixture contained RNA (1  $\mu$ g), oligo(dT) 20 and 10 mM dNTPs. The volume of the reaction mixture was prepared up to 13  $\mu$ l with nuclease-free water and incubated at 65 °C for 5 min. and retained on ice for quick chilling. Contents were centrifuged and collected into fresh Eppendorf tube. 5X strand buffer was added along with 0.1M DTT trailed by the integration of Reverse Transcriptase (III) enzyme to the reaction mixture. The whole reaction mixture was incubated for 30–60 min. at 50 °C, progressed by inactivation of the reaction by heating at 85 °C for 5 min. (Kaur et al., 2019)

**Quantitative Real-Time PCR (qRT-PCR) analysis**

The qRT-PCR experiment were performed on Bio-Rad CFX 96 system. The program was fixed up to an initial denaturation step at 50 °C for 20 s, 95 °C for 10 min. trailed by annealing step of 40 cycles at 95 °C for 15s and the ultimate amplification step at 60 °C for 1 min. This reaction was monitored by melt curve analysis using default parameters to check the PCR specificity by a stable increase in temperature from 60 °C to 90 °C. During the experiment, a gene using the least Cycle threshold (Ct) value was fixed for 1 to determine transcript abundance relative to other genes. The reference gene selected for qRT-PCR analysis was  $\beta$ -actin as a control based on previously reported work on *Cymbopogon martinii*. The expression level of unigenes was predicted using the Two-Fold ( $2^{-\Delta\Delta CT}$ ) process to normalize reference gene expression (actin). Values for each phase were taken as an average of two technical duplicates of each biological sample (Leaf and inflorescence) (Kaur et al., 2019).

**RESULTS AND DISCUSSION****Wild plant collection and identification**

The wild species of *Cymbopogon martini* (Roxb.) W. Watson presently explored for studies. Herbarium of the plant material was submitted to ICAR-National Bureau of Plant Genetic Resources (NBPGR) for authentication and conservation and provided with an Acc. Number: AC-62/2021). The species was further confirmed by DNA barcoding loci study and identified as *Cymbopogon martini* (Roxb.) W. Watson which was submitted to NCBI-Gen Bank (Acc. no. MW538957). Present flora explored for studies were subjected to *de novo* transcriptome analysis to generate voluminous transcriptome data. The same data were submitted to the NCBI SRA database (Acc. no. SRR15330310-Leaf and SRR15330309-Inflorescence). Based on the *denovo* transcriptome data obtained from the leaf and inflorescence of *C. martinii*, the seven unigenes were selected further for the differential gene expression investigation by quantitative Real-time PCR (qRT-PCR).

**Quantitative real-time PCR (qRT-PCR) validation for differential expression**

Quantitative real-time PCR (qRT-PCR) was subjected to inspect the differential expression levels of selected 7 unigenes from leaf and inflorescence tissues of *C. martinii*. The mRNA expression levels were stabilized to the level of housekeeping gene ( $\beta$ -actin) expression. The Ct values of experiment samples were calculated, and the data were expressed in terms of fold change over the control sample. The results showed a substantial level of gene expression in accordance with RNA-seq data. GPPS showed a higher level of gene expression in leaf and lower in inflorescence, whereas FDPS gene expressed at lower level in leaf tissue than in inflorescence, which shown that the terpenoid biosynthesis was more pronounced in leaves than in inflorescence at the period of flowering. A Parallel expression of



**Ashwini et al.,**

the ADH gene in leaf tissue was observed which showed higher expression when compared with its expression in inflorescence tissue. This described the potential role of the ADH gene in leaf over inflorescence during bioconversion of Geraniol to Geranial. Similarly, the TPS selected for expression analysis showed a high level of expression in leaf than in inflorescence implies the expression of TPS superior in leaf than in inflorescence. The gene expression studied in GES also exhibited that they are involved in the biosynthesis of Geraniol from Geranyl Pyro Phosphate (GPP) while ADH enzyme helps in the dehydrogenation of Geraniol to Geranial (reversible reaction). As Geraniol is the distinctive compound of *C. martinii* species, the expression of GES is advanced in leaf than in inflorescence. During inflorescence growth, Geraniol gets transformed into geranyl acetate hence forth, the GES expression is inferior.

LS gene accountable for the production of Linalool, a monoterpene is extensively used as fragrance and flavoring agents in cosmetic products, pharmaceuticals, perfumes, and foods (Sharmeen et al., 2021) revealed that expression of both the samples expressed similar expression levels. Where as the BSS gene is responsible for the biosynthesis of a sesquiterpene  $\beta$ -selinene and derivatives majorly contributing to the flavour and aroma. As one of the selinene derivatives (Selina-6-en-4-ol) present highly in the wild *C. martinii* essential oils of inflorescence studied here (Unpublished data/under review) showed a high level of expression in inflorescence and a low level in the leaf sample. Gene expression studies of selected unigenes showed that the transcriptome data obtained was consistent and reproducible which might be employed for future discoveries of key genes involved in terpenoid biosynthesis in the plant. Comparative expression of candidate genes in wild *C. martinii*. Real-time qPCR analysis of GPPS, FPPS, ADH, TPS, GES LS and BSS candidates in PRC: *C. martinii* leaf and inflorescence; GPPS: geranyl diphosphate synthase; FPPS: farnesyl diphosphate synthase ADH: Alcohol dehydrogenases; TPS: Terpene synthase; GES: Geraniol synthase; LS: Linalool synthase; and BSS: Beta Selinene synthase. The graph columns represent the mean  $\pm$  SD.

## CONCLUSION

The deposition level of terpenoids in plants were considerably varied among leaf and inflorescence of wild *Cymbopogon martinii*. (Roxb.) W. Watson. The terpene pathway-related genes chosen for the studies exhibited variation in level of expression of the particular genes could be the purpose for the differential build-up of terpenoid compounds in the essential oil. Consequently, exploration of the biosynthetic genes involved in terpenoid pathway provide profound understanding of terpene synthesis as well as the molecular basis for enhancement in the quality of this medicinal and aromatic plants through biotechnology, providing diverse genetic assets for further study.

### Supplementary data

Supplementary material related primer used in this work can be found in the online version at <https://doi.org/10.6084/m9.figshare.19121690>

## REFERENCES

1. Chappell, J. 1995. The biochemistry and molecular biology of isoprenoid metabolism. *Plant Physiol.* 107:1–6.
2. Das, M.K., Ansari, M.A., 2003. Evaluation of repellent action of *Cymbopogon martinii* Stapf var. *sofia* oil against *Anopheles sundaicus* in tribal villages of Car Nicobar Island, Andaman & Nicobar Islands, India. *J. Vector Borne Dis.* 40 (3/4), 100
3. Dubey, V.S., Luthra, R., 2001. Biotransformation of geranyl acetate to geraniol during palmarosa (*Cymbopogon martinii*, Roxb. wats. var. *motia*) inflorescence development. *Phytochemistry* 57, 675–680.
4. Ganjewala, D., Kumar, S., Luthra, R., 2009. An account of cloned genes of the methyl-erythritol-4-phosphate pathway of isoprenoid biosynthesis in plants. *Cur. Issues Mol. Biol.* 11, 135
5. Ganjewala, D., Luthra, R., 2007. Essential oil biosynthesis and metabolism of geranyl acetate and geraniol in developing *Cymbopogon flexuosus* (Nees ex Steud) Wats Mutant cv. GRL-1 Leaf. *Am. J. Plant Physiol.* 2, 269–275.



**Ashwini et al.,**

6. Ganjewala, D., Luthra, R., 2009. Geranyl acetate esterase controls and regulates the level of geraniol in lemongrass (*Cymbopogon flexuosus* Nees ex Steud.) mutant cv. GRL-1leaves. Zeitschrift für Naturforschung C 64, 251–259.
7. Gershenzon, J and Croteau. R 1993. Terpenoid biosynthesis: the basic pathway and formation of monoterpenes, sesquiterpenes, and diterpenes. Pp. 340–388 in t. S. Moore, ed. Lipid metabolism in plants. Crc press, bocaraton, fla.
8. Gupta, A.K., Ganjewala, D., 2015a. A study on biosynthesis of “citral” in lemongrass (*C. flexuosus*) cv. Suvarna. Acta Physiol. Planta 37 (240).
9. Gurminder Kaur, Surjeet Kumar Arya, Babita Singh, Sanchita Singh Yogeshwar Vikram Dhar, Praveen C. Verma, Deepak Ganjewala., 2019, Transcriptome analysis of the palmarosa *Cymbopogon martinii* inflorescence with emphasis on genes involved in essential oil biosynthesis. Ind. Crops prod. 140; 1-11 <https://doi.org/10.1016/j.indcrop.2019.111602>
10. Kalagatur, N.K., Nirmal Ghosh, O.S., Sundararaj, N., Mudili, V., 2018. Antifungal activity of chitosan nanoparticles encapsulated with *Cymbopogon martinii* essential oil on plant pathogenic fungi *Fusarium graminearum*. Front. Pharmacol. 9, 610. <https://doi.org/10.3389/fphar.2018.00610>.
11. Katiki, L.M., Chagas, A.C.S., Bizzo, H.R., Ferreira, J.F.S., Amarante, A.F.T.D., 2011. Anthelmintic activity of *Cymbopogon martinii*, *Cymbopogon schoenanthus* and *Mentha paprika* essential oils evaluated in four different in vitro tests. Vet. Parasitol. 183 (1- 2), 103–108. <https://doi.org/10.1016/j.vetpar.2011.07.001>.
12. MurbachTeles Andrade, B.F., Nunes Barbosa, L., B'ergamoAlves, F.C., Pereira Marques, A.F., Albano, M., Mores Rall, V.L., Brüggemann, H., Fernandes Júnior, A., 2018. The impact of *Cymbopogon martinii* essential oil on Cutibacterium (formerly Propionibacterium) acnes strains and its interaction with keratinocytes. J. Pharm. Pharmacol. 70 (12), 1688–1699. <https://doi.org/10.1111/jphp.13011>.
13. Rajeswara Rao, B.R., Rajput, D.K., Patel, R.P., 2015. Improving Yield and Quality of Palmarosa [*Cymbopogon martini* (Roxb.) Wats. Var. Motia Burk.] With Sulfur Fertilization. J. Plant Nutr. 38 (3), 384–396. <https://doi.org/10.1080/01904167.2014.957395>.
14. Sahu, S., Debata, B.K., Patnaik, J., 2000. Palmarosa and its improvement for geraniol production. J. med. aromat. Plants 22 (1B), 253–262.
15. Sangwan, N.S., Farooqi, A.H.A., Shabih, F., Sangwan, R.S., 2001. Regulation of essential oil production in plants. Plant Growth Regul. 34 (1), 3–21. <https://doi.org/10.1023/A:1013386921596>
16. Sharmeen B Jugreet, Mahomoodally M Fawzi, ZenginGokhan and Maggi Filippo. 2021. Essential Oils as Natural Sources of Fragrance Compounds for Cosmetics and Cosmeceuticals Molecules. 26(666): 1-24.
17. Sreenath, H.L., Jagadishchandra, K.S., 1988. In vivo and in vitro instability of B chromosomes in palmarosa grass (*Cymbopogon martinii* var. motia). Genome. 30 (6), 966–973. <https://doi.org/10.1139/g88-153>.
18. Verma, S.K., Kumar, B., Ram, G., Singh, H.P., Lal, R.K., 2010. Varietal effect on germination parameter at controlled and uncontrolled temperature in Palmarosa (*Cymbopogon martinii*). Ind. Crops Prod. 32 (3), 696–699. <https://doi.org/10.1016/j.indcrop.2010.07.015>.





Ashwini et al.,

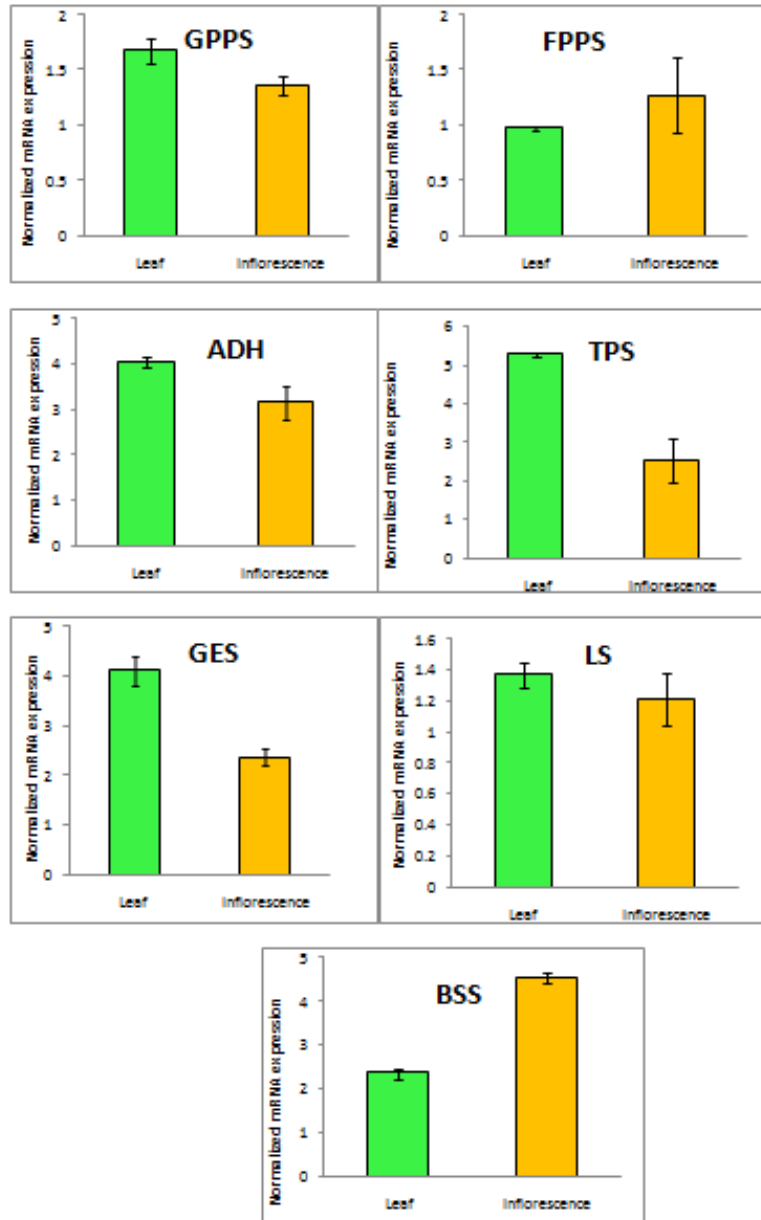


Fig 1: Comparative expression of candidate genes in wild *C. martinii*. Real-time qPCR analysis of GPPS, FPPS, ADH, TPS, GES LS and BSS candidates in PRC: *C. martinii* leaf and inflorescence; GPPS: geranyl diphosphate synthase; FPPS: farnesyl diphosphate synthase ADH: Alcohol dehydrogenases; TPS: Terpene synthase; GES: Geraniol synthase; LS: Linalool synthase; and BSS: Beta Selinene synthase. The graph columns represent the mean  $\pm$  SD.





## Perception of Students towards Online Learning during Covid-19 Pandemic

Fatima Lawan Zubair and Akanksha Srivastava\*

School of Education, Sharda University, Greater Noida, India.

Received: 19 Nov 2021

Revised: 18 Dec 2021

Accepted: 21 Jan 2022

### \*Address for Correspondence

**Akanksha Srivastava**

School of Education,

Sharda University,

Greater Noida, India.

Email: akanksha.srivastava@sharda.ac.in



This is an Open Access Journal / article distributed under the terms of the **Creative Commons Attribution License** (CC BY-NC-ND 3.0) which permits unrestricted use, distribution, and reproduction in any medium, provided the original work is properly cited. All rights reserved.

### ABSTRACT

Higher Institutions of learning have shifted to online learning due to covid-19 pandemic. This has now made all stakeholders that are involved in the institutional setting including the students, teachers and administrators in making all possible efforts to make use of the available technology at hand to sustain the educational system as e-learning is replacing the conventional classroom setting worldwide. In this regard, this study was conducted to ascertain students' perception of online learning and determine its effectiveness during the covid-19 pandemic. For the research design, a descriptive survey was used for the study. A sample of 100 students was selected through random sampling. The instrument used for data collection is a 12 item questionnaire adopting the four point likert format that was designed for the study. The data collection instrument was validated by experts in the department of education, Sharda University Greater Noida, India. The data collected was answered using descriptive statistics including tables, frequency distribution, bar graphs and mean scores. The study results showed that the students have a positive perception towards online learning. They find it effective because it is convenient, has ease of attendance and promotes classroom communication. The findings of this study will help teachers, policy makers and school administrators in decision making, improving the quality of e-learning and supporting students' online learning.

**Keywords:** Perception, Technology, Effectiveness, Online learning, Covid-19, Pandemic

### INTRODUCTION

The world today is in an era of advanced technology and digitalization where the role of information and communication technology (ICT) cannot be overemphasized. This advancement in technology has dramatically influenced the educational sector. It is evident that teaching and learning in higher institutions across the globe have undergone transformation since the introduction of ICT. This aspect of ICT that has brought about change in the educational sector is e-learning [5]. E-learning is 'a virtual learning environment in which a learners interaction with

38321



**Fatima Lawan Zubair and Akanksha Srivastava**

materials, peers and/or instructors are mediated through information and communication technologies. It is different from the traditional environment because ICT are used as tools to support the learning process and taking advantage of network infrastructures, learning can occur anywhere using many types of resources'.([22],p.513). [7] defined E-learning 'as information and communication technologies used to improve students' learning'. With the advancement in technology, many developing countries of the world have adopted online learning at a great pace due to the availability of technology and technological resources at hand. Additionally, most universities have adopted the use of LMS to promote teaching and learning even before the advent of covid-19. LMS is an online software which is used to plan, execute and asses a specific learning process. It helps in maintaining online collaboration on the internet, online teaching, uploading records and assignments, making course calendars, managing grades and also course activities.

However, the use of technology/e-learning in teaching and learning has become more evident with novel corona virus disease, which has led to the closure of schools and institutions of higher learning across the world. The decision to close down institutions across the globe was in an attempt to contain the spread of covid-19 which has led to a shift from conventional learning methods to online teaching or e-learning methods. Institutions are now using different methods to further the educational activities through videoconferencing and WhatsApp among others. The students have also accepted the educational transformation due to its ease of use and attendance, flexibility in terms of time and location, unlimited access to e-resources and cost effectiveness. Both teachers' and students can now share contents and documents through different platforms. However e-learning also has some limitations including lack of ICT knowledge among both the teachers and students, lack of stable power supply and good network connection especially in the developing countries of the world and shortage of infrastructural resources like computers. Looking at the numerous advantages and limitations of e-learning, it becomes very essential to determine how the students perceive online learning to be during the pandemic, find out its effectiveness and provide suggestions on how it can be improved.

**Review of Related Literature**

Covid-19 has disrupted the educational sector all over the world including India, causing million of students to be affected. The implementation of e-learning in India is posing a great challenge to both students and teachers since India is highly diversified with class divides. Additionally, most schools were not implementing online learning before covid-19 pandemic, not all students have accessibility to the internet at home and not all teachers are well equipped with the knowledge of using these technologies making it difficult for the students and teachers to adapt to the new method of teaching and learning. Social, technical and financial problems are some of the issues faced by both the teachers and students during online education [12]. However, most private schools in the country have shifted to online learning, thereby leaving behind the students from the disadvantaged group and those in the remote areas due to the digital divide. This is the same challenge faced by most students in developing countries. In its effort to promote teaching-learning during the pandemic, UNESCO, (Under National Learning Platforms and tools by UNESCO 2020) provided support especially for the weaker class [20]. Schools in India have been on lockdown since the beginning of March in order to prevent the spread of the disease. That is why schools have taken the decision towards e-learning because it is not clear as to when schools will resume or open fully as the cases of Covid-19 are increasing day by day. The shift to online learning in schools have now made all stakeholders that are involved in the institutional setting ranging from the students to teachers and administrators in making all possible efforts to use the available technology at hand to further the education process in order to avoid the gaps that may result due to the current situation [1].

If used effectively, technology enables both teachers and students to engage and collaborate mutually. Several studies have been conducted on finding out the effectiveness of e-learning and students opinion towards online learning before the pandemic and during covid-19 pandemic, [19,15]. In a study carried out on the '*perception of students towards e-learning during covid-19 at a private medical college in Pakistan*', the study revealed that the students did not prefer e-learning to face-to-face learning due to the fact that 77.4% of the students showed negative attitude towards e-learning that it is not secure and the impact of e-learning is less [1]. [11] revealed in his study students'



**Fatima Lawan Zubair and Akanksha Srivastava**

positive attitude towards e-learning and their acceptance of the new method of teaching and learning [11]. Despite the fact that students miss the face to face classes, they have positively absorbed the shift from physical setting to virtual setting [8]. Similarly, in agreement with these results it was revealed that in Pakistan, a positive relationship was found between technology acceptance and e-learning during covid-19. Furthermore, the findings revealed that the respondents showed a favorable attitude towards e-learning and its impact on the student's academic performance [3].

Students find e-learning to be very useful as they like the idea considering the fact that it is innovative and thus should be highly encouraged and enhanced [14]. Students like the shift from physical education to digital education and would like to continue it in the future [6]. Students have a positive attitude towards e-learning and their attitude is not affected by their locality or gender [10]. In a study on the '*analysis of students attitude towards e-learning: case of computer science students in Nigeria*', the results indicated that e-learning is very effective as it provides the students with quest for knowledge and the opportunity to make use of computers in an effective manner [17]. This corroborates with the findings that the students have a positive attitude towards e-learning and that it has ease of use [2]. Thus we can say that the effectiveness of online learning highly depends on the level or degree of its acceptance by the students or users. According to the technology acceptance model, the two most important factors that determine technology acceptance are its perceived usefulness and perceived ease of use. The satisfaction with online learning is very much significant in the attitudes towards online classes during covid-19 pandemic [18]. That is why it becomes important at this phase of covid-19 to explore the students' perception towards online learning and to determine its effectiveness during the pandemic.

**Research Objectives**

This study aim at investigating the perception of students towards online learning during covid-19 pandemic. To conduct the study, the following objectives were formulated:

- To find out the perception of students towards online learning during covid-19 pandemic.
- To assess the effectiveness of the online teaching classes during covid-19 pandemic.
- To provide suggestions on how online learning can be improved.

**METHODOLOGY****Context Description**

In order to find out the students perception towards online learning during covid-19 pandemic, the study was conducted at Sharda University Greater Noida, India. The university was chosen as it also adopted online learning during the pandemic and the researchers for the study at the time of collecting this data are part of the university which made it convenient for them to get the necessary permission to undertake the research and distribute the questionnaire to the students.

**Design and Participants**

The research is quantitative and also descriptive in nature which was opted because it explores numerous ideas, thoughts and notions of the respondents of the study. All the students of Sharda University Greater Noida, India were the population of the study. The university is an international university as the student respondents are from different nationalities studying different courses and pursuing different programs. A total of 100 students (male and female) were selected as sample using the random sampling technique.

**Data Collection Instrument**

The researcher developed a self constructed questionnaire in the light of the objectives of the study to collect data from the students on their perception towards online learning during covid-19 pandemic. The instrument was validated by experts in the department of education from Sharda University Greater Noida, India. The questionnaire has three sections. The introductory section provides information on the topic being studied and the necessary





**Fatima Lawan Zubair and Akanksha Srivastava**

instructions for the respondents to fill in the questionnaire. The second section contained information on personal details of the respondents as gender, nationality, discipline and their choice of devices for taking online classes. The third section had 12 items that were given in both positive and negative statements which are related to student-teacher interaction, teaching-learning process and assessment. The respondents were required to show their level of agreement or disagreement to the statements given. The items were given on a four point rating scale as Strongly agree (SA)=4, Agree (A)=3, Disagree (D)=2 and Strongly disagree (SD)=1. The researcher administered the questionnaire through online mode using Google form which was shared with the students through WhatsApp due to the pandemic and lockdown situation as majority of the students have gone back to their home countries and are taking the classes online. The entire sample responded to the questionnaire with utmost cooperation which as a result, 100% questionnaires were retrieved.

**Data Analysis**

The data collected through the questionnaire was organized, arranged, tabulated and analysed using two methods. The personal information of the respondents on gender, discipline, nationality and choice of devices for online classes were analysed using descriptive statistics which include the use of frequency distribution. For easy analysis, the discipline or courses of study were grouped into five. Basic sciences which include courses like physics and biotechnology; Engineering which include courses as computer science, civil, mechanical and electrical engineering; Business studies which includes courses like banking and finance and economics; Allied health sciences which includes courses like pharmacy and nursing; Education which includes courses like B.A..B.ED and B.SC.B.ED. While the 12 items on four point rating scale were presented and analyzed using bar graphs and mean scores respectively. A mean criterion or decision line of 2.50 was set for the study i.e. a mean score of 2.50 and above was considered as agree while a mean score below 2.50 was considered as disagree.

**RESULTS**

**Table 1** presents the personal information of the respondents which include information on gender, nationality, discipline and their choice of devices used to take online classes. The results shows that majority of the respondents are male which constitutes 54% while 46% are females. The students belong to different nationalities as 20% are from Nigeria, 34% are from India, 16% belong to Tanzania, 2% from Afghanistan, 10% from Turkmenistan and 18% are from Zimbabwe. The students are pursuing different courses. 24% of the respondents are pursuing Allied health science courses, 22% are studying business studies courses, 32% are studying engineering courses, 14% are pursuing basic science courses, and the rest are pursuing education courses which constitutes 8% of the respondents. 64% of the students said they use computers to take their classes, 28% use mobile phones and 8% make use of other devices for online learning.

**Table 2** shows that items 1, 2, 3, 4 and 5 on students' perception towards online learning obtained a mean score of 2.6, 2.9, 3.2, 3.1, and 2.7 respectively which are above the mean criterion of 2.50, while item 6 obtained a mean score of 2.0 which is below 2.50. The results shows that the students rated items 1-5 as agree and item 6 as disagree. The result implies that most of the students have positive attitude towards online learning despite the fact that it requires investment in both technology and resources, they find teacher-student interaction to be better through online learning, it promotes group communication, classroom communication and also makes it easy for the students to attend classes. This is further illustrated in the graph below;

**Table 3** shows that items 7, 8, 9 and 12 on effectiveness of online learning obtained a mean score of 1.6, 2.2, 1.9 and 2.1 respectively which are below the mean criterion of 2.50, while items 10 and 11 obtained a mean score of 3.6 and 3.3 respectively which are above 2.50. The results shows that the students rated items 7, 8, 9 and 12 as disagree and items 10 and 11 as agree. The results implies that, most of the students find online learning to be as effective as classroom learning that it is convenient, it does not limit students feedback, and does not limit students ability to develop communication skills. This is further illustrated in the graph below;





Fatima Lawan Zubair and Akanksha Srivastava

## DISCUSSION

The spread of covid-19 pandemic has made educational institutions to shift to online learning. That is why it becomes essential at this phase to find out the perception of students towards online learning and its effectiveness during the pandemic. The university was chosen as it has adopted online teaching/learning and the researchers were part of the university at the time of conducting the study. One hundred students were selected as sample randomly. The paper takes into consideration only students of Sharda University Greater Noida, India as teachers, administrators and other universities were not included in the study. Findings of the study showed that 7 out of 12 items obtained a mean score that is above the criterion 2.50. With regards to research question one (1), the findings imply that the perception of the students' towards online learning during covid-19 was positive. This was evident with the respective scores that were obtained which are above 2.50. The positive perception of the students was due to its ease of attendance, promoting classroom and group communication and they find teacher-student interaction to be better through online learning. With respect to research question two (2), it reveals that the students find online learning to be as effective as classroom learning, that it is convenient, does not limit students feedback, does not limit students ability to develop communication skills and does not make the teachers to focus more on the theoretical aspect of teaching/learning than the practical aspect. These factors have contributed to the positive perception of the students towards online learning. These findings are in line with the results which revealed that covid-19 did not influence the attitude of student-teachers towards e-learning. It was also observed that there was no significant difference between male and female student-teachers attitude towards online learning during the pandemic [16].

Students are happy with e-learning due to its utilization of time in attending online classes during the pandemic [9]. Supporting this, it was also reported that from the teachers, students, and parents' perspective, e-learning is very effective in the pandemic situation and also for future conditions [13]. In agreement with the results it was further explained that in Pakistan, a positive relationship was found between technology acceptance and e-learning during covid-19. Furthermore, the findings revealed that the respondents showed a favorable attitude towards e-learning and its impact on the student's academic performance [3]. Other studies that were conducted prior to the advent of covid-19 also revealed a positive attitude of students towards e-learning. Supporting the findings it was remarked that students find e-learning to be very comfortable because it provides them with the opportunity to become more innovative through the use of computer technology [4]. These findings are in consonance with that of the results that revealed e-learning to be very effective as it provides the students with the opportunity to make use of computers in an effective manner and also provides them with the quest for knowledge [17]. However, other studies are in congruence with the findings of this paper. It was reported that the students do not prefer e-learning to face-to-face learning. 77.4% of the respondents believed that e-learning is not secure and its impact is less [1]. Students were on the view that online learning would not be the same with face-to-face learning [21]. This implies that the students prefer face-to-face learning over e-learning.

## CONCLUSION

It is evident that majority of the students have a positive perception towards online learning, they find it to be effective and they make use of computers to take online classes. This implies that the students have accepted digital technology and the use of computers to support teaching and learning during covid-19 pandemic. A lot of factors have contributed to the positive perception of the students towards online learning, among them are; it's convenient nature, ease of attendance, promoting both classroom and group communication and does not limit students feedback but promotes better interaction between teacher and student. To improve the perception of students towards online learning, both teachers and administrators need to work together to improve the quality of e-learning. The findings of this paper will help in tackling such potential issues that may arise in the future.

### Recommendations

The important role that technology and e-learning plays in today's world cannot be underestimated especially with the pandemic. This is why both teachers and administrators need to work together to improve the quality of e-learning. School managements need to ensure that all necessary resources and technological tools are made available





### Fatima Lawan Zubair and Akanksha Srivastava

and accessible to both the teachers and students and the teachers should always keep themselves updated on how to integrate technology into teaching-learning process through attending workshops and seminars as well as making use of a flexible approach towards online learning. It will increase students' participation in the online classes. Staying in contact with the parents of the students will also help in supporting the students' online learning.

#### Limitations of the Study

The limitations of the study lie in the examined or sampled population. The study is limited to students of Sharda University Greater Noida India which narrows down the scope. Therefore, the results may not be generalized to other populations as the responses of the students could merely represent their perceptions of online learning during covid-19 pandemic based on the delivery method and teaching strategies used by their teachers, platforms used to take the classes and the students' level of acceptance of technology. Thus further studies can be conducted by analyzing other universities and finding out the impact of online learning on the academic performance of students. Despite these limitations, the findings of the study provide useful information with regards to e-learning and how it can be improved during the pandemic.

#### Funding Source

This research did not receive any specific grant from funding agencies in the public, commercial or not-for-profit sectors.

## REFERENCES

1. Abbasi, S., Ayoob, T., Malik, A., and Memon, S.I. *Perception of Students Regarding E-learning during Covid19 at a Private Medical College*. Pak J Med Sci. 2020; 36(COVID19-S4): COVID19-S57-S61. <https://doi.org/10.12669/pjms.36.COVID19-S4.2766>
2. Adewole-odeshi, E. (2014). *Attitude of Students Towards E-learning in South-west Nigerian Universities: An Application of Technology Acceptance Model*. Library Philosophy and Practice (e-journal). 1035. <https://digitalcommons.unl.edu/libphilprac/1035>.
3. Alhumaid, K., Ali, S., Waheed, A., Zahid, E., & Habes, M. (2020). *Covid19 & E-learning: Perception and Attitudes of Teachers Towards E-learning Acceptance in the Developing Countries*. Multicultural Education, Vol 6(2), Pp.100-115. DOI: 10.5281/zenodo.4060121.
4. Bali, S., & Liu, M.C. (2018). *Students Perception Towards Online Learning and face-to-face Learning Courses*. Journal of Physics: conference.series 1108(2018) 012094. Doi:10.1088/1742-6596/1/012094.
5. Basse, U., Umoren, G., Akuegwu, B., Udida, L., Ntukidem, P., and Ekabua, O. (2007). *Nigerian Graduating Students Access to E-learning Technology: Implication for Higher Education Management*. Proceedings of 6th International Internet Education Conference (ICT-learn2007) held in Cairo Egypt from 2-4 September 2007 p59-76.
6. Bogdandy, B., Tamas, J., and Toth, Zsolt. (2020). *Digital Transformation in Education during Covid-19: a case study*. A Paper Presented at the 11<sup>th</sup> IEEE International Conference on Cognitive Infocommunications held from 23-25 September 2020. DOI: 10.1109/CogInfoCom50765.2020.9237840.
7. Ellis, Robert A., Ginns, Paul., & Piggott Leanne. ( 2009). *E-learning in Higher Education: some key aspects and their Relationship to Approaches to study*. Journal of Higher Education Research and Development, vol 28(3), p303-318. <https://doi.org/10.1080/07294360902839909>
8. Giovannella, C. (2020). *Effect Induced by the Covid-19 Pandemic on Students Technologies and Distance Learning*. Proceedings of the 5<sup>th</sup> International Conference on Smart Learning Ecosystems and Regional Development (pp105-116). DOI:10.1007/978-981-15-7383-5\_9.
9. Jena, P.K., (2020). *Online Learning during Lockdown Period for Covid-19 in India*. International Journal of Multidisciplinary Educational Research. Vol. 9, issue 5(8), p82-92. [http://ijmer.in/issues/volume9/volume9-issues5\(8\).aspx](http://ijmer.in/issues/volume9/volume9-issues5(8).aspx)
10. Joshi, H., & Thakkar, S. (2017). *Students' Attitude Towards E-learning*. International Journal of Advanced Engineering and Research Development, Vol. 4, issue 11, p209-213. DOI:10.21090/IJAERD.15380
11. Khan, M.A., Vivek., Nabi, M.K., Khajah, M., & Tahir, M. *Perception Towards E-learning during Covid-19 Pandemic in India: An Empirical Study*. Sustainability 2021, 13, 57. <https://dx.doi.org/10.3390/su13010057>.





**Fatima Lawan Zubair and Akanksha Srivastava**

12. Lassoued, Z., Alhendawi, M., & Bashitialshaaer, R. (2020). *An Exploratory study of Obstacles for Achieving Quality in Distance Learning during the Covid-19 Pandemic*. Education Sciences, 10(9), 232. <https://doi.org/10.3390/educsci10090232>
13. Lonescu, C.A., Paschia, L., Nicolau, N.L.G., Stanescu, S.G., Coman, M.D., & Uzlau, M.C. *Sustainability Analysis of the E-learning Education System during Pandemic Period-Covid19 in Romania*. Sustainability, 2020, 12(21), 9030; <https://doi.org/10.3390/su12219030>.
14. Mamattah, R.S. (2016). *Students' Perception of E-learning*. Unpublished Dissertation, Department of Behavioural Sciences and Learning, Linkoping University. Retrieved from <http://www.diva-portal.org/smash/get/diva2:925978/FULLTEXT01.pdf>
15. Mishra, L., Gupta, T., & Shree, A. (2020). *Online Teaching- Learning in Higher Education during Lockdown Period of Covid-19 Pandemic*. International Journal of Educational Research open in press. <https://doi.org/10.1016/j.ijedro.2020.100012>
16. Nachimuthu, K. (2020). *Student Teachers Attitude Towards Online Learning During Covid19*. International Journal of Advanced Science and Technology, vol 29(6), pp 8745-8749. Retrieved from <http://sersc.org/journals/index.php/IJAST/article/view/26057>
17. Ogunnowo, O.O. (2016). *Analysis of Students Attitude Towards E-learning: Case of Computer Science Students' in Nigeria*. Unpublished Dissertation, Eastern Mediterranean University, Gazimagusa, North Cyprus. Retrieved from <http://i-rep.emu.tr:8080/jspui/bitstream/11129/2987/1/ogunnowoolumayowa.pdf>
18. Pandey, D., Ogunmola, G.A., Enbeyle, W., Abdullah I, M., Pandey, B.K., & Pramanik, S. (2021). *Covid-19: A framework for Effective Delivering of Classes during Lockdown*. Human Arenas: <https://doi.org/10.1007/s42087-020-00175-x>.
19. Patricia, A. (2020). *College Students' use and Acceptance of Emergency Online Learning due to Covid-19*. International Journal of Educational Research open in press. <https://doi.org/10.1016/j.ijedro.2020.100011>
20. UNESCO.(2020).UNESCO Report,'COVID-19 Educational Disruption and Response'.Retrieved from 16 June2020.
21. Unger, S., & Meiran, W.R. (2020). *Students Attitude Towards Online Education during COVID19 Viral Outbreak of 2020: Distance Learning in a Time of Social Distance*. International Journal of Technology in Education and Science (IJTES), 4(4), 256-266. DOI:10.46328/ijtes.v4i4.107
22. Wan, Z., Wang, Y., Haggerty, N. (2008). *Why People Benefit from E-learning Differently: The Effect of Psychological Processes on E-learning Outcomes*. Information and Management, 4(8), 513-521. doi:10.1016/j.im.2008.08.003

**Table 1: Personal information of respondents (N=100)**

Variables	Categories	Frequency
Gender	Male	54
	Female	46
Nationality	Nigeria	20
	India	34
	Tanzania	16
	Afghanistan	2
	Turkmenistan	10
	Zimbabwe	18
Discipline	Business ( Banking & Finance, & Economics)	22
	Basic sciences ( Physics & Biotechnology)	14
	Allied health sciences (Pharmacy, Nursing & Physiotherapy)	24
	Engineering ( Computer science, Civil & Mechanical Engineering	32
	Education (B.A.B.ED, BSC.B.ED)	8
Choice of electronic device	Computer	64
	Mobile phone	28
	Other devices	8





**Fatima Lawan Zubair and Akanksha Srivastava**

**Table 2: Mean rating of students perception towards online learning**

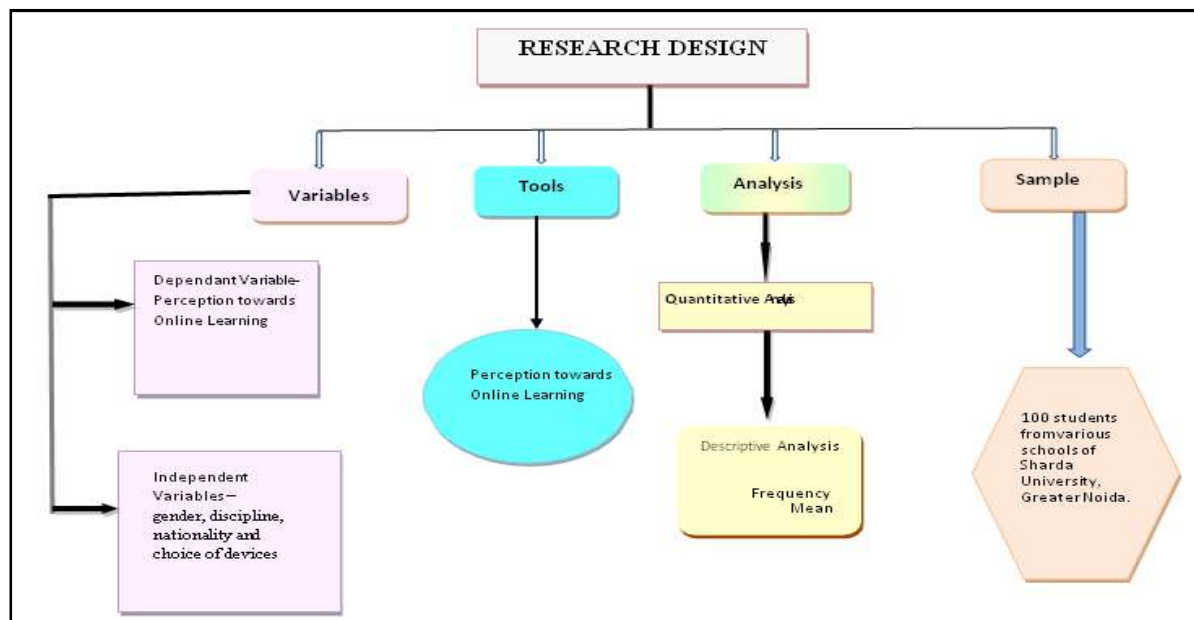
S/ N	Item Statement	SA	A	D	SD	N	M	Decision
1	Delivering classes through online requires investment in both technology and resources	14	42	38	6	100	2.6	Agree
2	Teacher-student interaction is better through online mode	20	66	6	8	100	2.9	Agree
3	Online learning promotes classroom communication	34	54	10	2	100	3.2	Agree
4	Online learning promotes group communication among students	30	58	10	2	100	3.1	Agree
5	Online learning leads to ease of attendance for students	12	56	22	10	100	2.7	Agree
6	Online learning reduces cost	0	14	72	14	100	2	Disagree

SA= Strongly agree, A=Agree, D= Disagree, SD= Strongly disagree, N= Number of respondents, M= Mean

**Table 3: Mean rating of effectiveness of online learning**

S/N	Item statement	SA	A	D	SD	N	M	Decision
7	Online learning limits students feedback	4	18	14	64	100	1.6	Disagree
8	Teachers focus more on theory than practice through online learning	10	16	54	20	100	2.2	Disagree
9	Assessment through online mode leads to cheating from the students	0	12	72	16	100	1.9	Disagree
10	Online learning is convenient	60	40	0	0	100	3.6	Agree
11	Online learning is as effective as classroom learning	64	18	2	16	100	3.3	Agree
12	It leads to lack of communication skill development on the part of the students	4	16	70	10	100	2.1	Disagree

SA= Strongly agree, A=Agree, D= Disagree, SD= Strongly disagree, N= Number of respondents, M= Mean



**Fig 1: Research Design and participants**





Fatima Lawan Zubair and Akanksha Srivastava

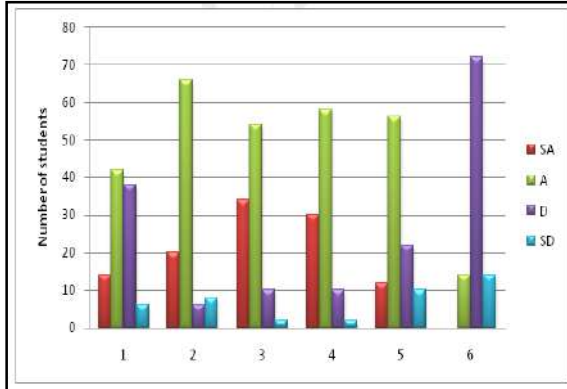


Fig 2: Students perception towards online learning

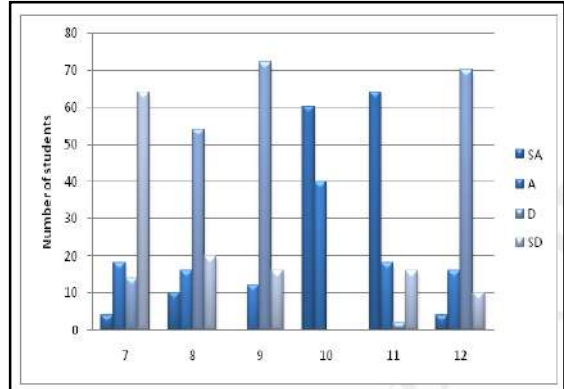


Fig 3: Effectiveness of online learning





## The Role of the Teacher and New Technologies in Learning and Teaching of French as a Foreign Language

Shelly Bohra<sup>1\*</sup> and Tanuja Yadav<sup>2</sup>

<sup>1</sup>Research Scholar, Department of Languages, Manipal University Jaipur, Jaipur, Rajasthan, India.

<sup>2</sup>Associate Professor, Department of Languages, Manipal University Jaipur, Jaipur, Rajasthan, India.

Received: 08 Dec 2021

Revised: 20 Dec 2021

Accepted: 10 Jan 2022

### \*Address for Correspondence

#### Shelly Bohra

Research Scholar,

Department of Languages,

Manipal University Jaipur,

Jaipur, Rajasthan, India

Email: shellybohra@gmail.com



This is an Open Access Journal / article distributed under the terms of the **Creative Commons Attribution License** (CC BY-NC-ND 3.0) which permits unrestricted use, distribution, and reproduction in any medium, provided the original work is properly cited. All rights reserved.

### ABSTRACT

Methodologies of teaching and learning foreign languages have evolved considerably. Political, economic, technological and cultural developments have played a major role in the emergence of new methods in the process of teaching a foreign language. Learning and teaching French as a foreign language is an asset nowadays. We started to learn and teach the French language through textbooks and we were completely dependent on the teacher. But as we advanced, the students became more and more autonomous with the development of methodologies. The teacher nowadays plays the role of guide. The use of technology has facilitated the learning of the French language

**Keywords:** methodologies, teaching, learning, teacher, technology

### INTRODUCTION

Someone has rightly said, « *Un homme qui parle deux langues vaut deux personnes.* » That is to say, a man who speaks two languages is worth two people. This sentence indicates the importance of learning and teaching a foreign language. Nowadays in the era of globalization, knowing a foreign language is one of the most important educational goals of the world. A language plays a bridging role between different cultures helping to improve an individual's social skills and overall communication. In addition, knowledge of the foreign language allows us to communicate and understand people from foreign countries. Over the years, the methodologies for learning and teaching a foreign language, particularly the French language, have been evolving. In the teaching and learning of French as a foreign language, different methodologies like the traditional methodology, direct methodology, audio-oral methodology, audio-visual methodology, communicative approach, actional approach appeared and the changes in them were based on the goals of the designers and learners of French.



**Shelly Bohra and Tanuja Yadav****Methodologies of teaching and learning French as a foreign language (FLE)**

The learning objectives were very different during the traditional methodology. This methodology also called as the grammar-translation, began in the 18th century (Christine Tagliante, 1994). The cultural objective was in priority and the language was studied for its literature and general culture. The text was just meant for translation and it was studied for its grammar or glossary. Direct translation from French into the mother tongue was the method of teaching. The teaching of grammar played an essential role. The course was completely guided and explanatory. The teacher spoke and the students listened, thus constituting a linguistic model to emulate. The teacher played a dominant and central role. He had all the knowledge and authority. He chose the text and prepared the exercises. He asked questions and corrected the answers. Through this power of knowledge, he became the 'master' of the class. The natural method that coexisted with this methodology emphasized the oral aspect in language learning and foreign languages. Both the teacher and the learner used the target language with recourse to the mother tongue from time to time. The use of technology did not exist during this period.

The Direct Methodology began to be used in 1902. It aimed to develop the competence of real communication in the learner, avoiding the use of the intermediary, the mother tongue. The course was inductive. The teacher explained the vocabulary using objects or pictures and the conversation exercises were practiced. This methodology was imposed and required teachers to have a perfect command of the oral language. In addition, to practice phonetics, some classes had "talking machines". But because of technical difficulties, teachers discouraged using it. Now there was a great need for a textbook. Besides, wall charts accompanied with textbooks were used as the teaching material. The audio-oral methodology in the years 1930-1960, promoted oral practice of the language in class, the active method made the child learn to speak by speaking. There were three primary methods. The repetitive method was based on the linguistic forms, imprinted on the child's mind through continuous and intensive listening and reuse. In the imitative method, the child learnt by imitating, the sounds produced by his relatives, even before understanding them. The intuitive method emphasized the psychological development of the student and that gave a favorable atmosphere to his activity. According to Skinner's Theory of Stimulus-Response-Reinforcement Behaviorism for the Language Lab motivates students to speak in the target language. Oral and a strong exposure to the target language are thus put in advance, which called for the intense use of magnetic recordings. The recordings were intended for listening comprehension and rehearsal exercises. Oral supports increased in response to these new needs. The teacher possessed the technical knowledge and know-how.

Another methodology, Audio-Visual at the beginning of the 1950s, gradually integrated new technologies. This methodology was built around the joint use of image and sound. Audiovisuals were integrated in the form of films, radio extracts or records. The use of tape recorders brought models of pronunciation into the classroom. The teaching aids required a new organization of the class and the teacher coordinated all. The use of different media organized the written, oral and iconography, and managed to exploit them by putting them in touch. The teacher taught using the language laboratory. Learning happened through hearing and sight. The Audio-Visual methodology, SGAV, allowed quick learning that enabled to communicate orally with native speakers of foreign languages. According to P.Martinez "The SGAV methodology required the establishment of a heavy teaching device which included specific training for teachers through internships, significant material costs of setting up (tape recorder / language laboratory, etc.), and restrictive teaching arrangements: reduced number of learners / intensive weekly teaching / long-term training (2 to 3 years)." The communicative approach was the new methodology that developed in the 1970s in France. The main goal of this methodology was to focus on learning communication and to provide pedagogy more adapted to the needs of the learners. From now on, the status of the pupil, the subject taught and the means of teaching change. The learner became active; the pedagogical relationship mainly took into account the characteristics of the whole class and of each individual in specific. Its needs were analyzed in order to develop the progression of the teaching. The progression of learning remained no longer linear but rather spiral. The learner became the central point of the course, just like his needs and expectations. According to the psychologist Piaget (1926).





**Shelly Bohra and Tanuja Yadav**

« L'action et l'expérience du monde jouent un rôle prépondérant dans l'élaboration des processus cognitifs. L'enfant construit ses connaissances de son environnement en fonction non seulement de ses perceptions et des enseignements, mais aussi sur la base des expériences et des découvertes qu'il fait en agissant sur les objets » That is the action and the experience of the world play a preponderant role in the elaboration of cognitive processes. A child constructs his knowledge of environment based not only on his perceptions and teachings, but also on the basis of the experiences and discoveries he makes by acting on objects. The learner builds knowledge and skills in collaboration with the teacher. The teacher must do the work of creating exercises, texts with the ICT. The learner is also led towards progressive autonomy. Fabrice Barthélémy emphasizes "speech acts" in the learning situation. According to L. Porcher "that the learner will have to accomplish in certain situations, towards certain interlocutors and in connection with certain objectives or notions"

To do this, we need real documents that are to say not manufactured, rather "authentic documents" (Cuq, 2003). Complementary books and the textbooks as learning materials therefore gave the teacher freedom of use. The focus was on the four skills, oral comprehension and expression and written comprehension and expression. The evaluation took place in a formal, mutual and self-paced way. The teacher therefore took the role of facilitator, guide or mediator of knowledge. In order to be a facilitator, the teacher's task became more efficient and in the process he integrated ICT, "Information and communication technologies for education" in his course. The Common European Framework of Reference for Languages (henceforth CEFR or Framework) (Council of Europe, 2001) constituted the reference document on the conception of language teaching in Europe today. So for the action methodology, the use of ICT became compulsory in the teaching and learning of FLE. Learners must identify themselves as "users" of the target language. Now, the teacher was obliged to compose environments and scenarios inspired by reality to motivate each of the learners to learn the foreign language. The teacher took into account the needs of the learners and directed his course according to the objectives while waiting for their progress. It all depended on the successive interaction between teacher and learner. The initiation of the course with the ICT facilitated learning by empowering learners.

**The advantages of new technologies in teaching and learning French as a foreign language**

We live in a world where new technologies dominate all areas of education, especially in the teaching and learning of foreign languages. Of course in French too, learners are fascinated by them. As Fabrice Barthélémy says "By their attractive, motivating, authentic aspect, but also their rhythm or capacity of adaptation, the media are more and more privileged by the learners of a foreign language, whether in an institutional environment or within the framework of a self-taught methodology. "Multimedia in education is an interesting and motivating subject. There are undeniable advantages of ICT in teaching and learning French as a foreign language. The learner is in contact with the language and the culture in the authentic way. He can communicate with people of different languages. At the same time, it can rely on mutual teaching or language exchanges. It gives him the opportunity to meet real communication situations. The integration of video, sound sequences, graphics or animation in a language course gives it a more stimulating and dynamic character. The learner is exposed to native accents which give him a desire for authentic communication and promotes the acquisition of intercultural competence. New technologies constitute an inexhaustible reservoir of documentaries and educational materials. Let us take a case of teaching and learning French as a foreign language to school students in Jaipur. The availability of French newspapers, articles and books ahead of educational technology is always faster or unavailable. With multimedia, we have constant and inexhaustible access to any type of document, encyclopedia, dictionaries, a press article, archives, films, various documents. According to Carl Rogers "The only knowledge that can influence the behavior of an individual is that which he discovers for himself and that he appropriates" To this extent, ICTs help the learner not only in the absorption of content and knowledge but also in autonomy and the construction of knowledge. Moreover, acceleration of learning time and success at school failure are the other advantages that can be mentioned here.

**The role of the teacher with ICT in teaching and learning French as a foreign language**

Now where multimedia is presented as a panacea, we must think carefully about the role of the teacher. There is a broadening of the role of the teacher with the ICT. So he has acquired a new role of moderator, facilitator or



**Shelly Bohra and Tanuja Yadav**

animator. Previously he was the 'master' of the class with a textbook, chalk and a blackboard. The teacher was the direct transmitter of knowledge and the evaluator. Learners effortlessly took class notes. The teacher facilitated the path of learning but lacked motivation among the students. In case of role as a mediator, a teacher makes accessible to the learner the point that the learner cannot reach alone. The teacher has a worthy awareness of the problems encountered by the learners. He teaches new knowledge and makes his illustration with photos, films or with a computer that integrates text, sound and video. The presence of new technologies establishes a dialogue between the teacher and his students. So he helps the learners to develop their knowledge. The course remains semi-guided with new technologies in the learning situation. The teacher provides documents and work plans to the learners. Also, he helps them in the structuring of thoughts. According to B. Devauchelle, the course remains semi-guided with new technologies in the learning situation. He emphasizes that « *Elles modifient la relation pédagogique enseignant élève et changent le rapport du savoir.* » The technology used in classrooms modifies the teacher-pupil pedagogical association and transforms the knowledge rapport. It guides learners with strategies of learning and teaching when using new technologies. The teacher therefore plays the role of animator and facilitator. These roles require technical knowledge from the teacher. If the teacher is well equipped with these techniques, he can suggest documents and materials readily available through the ICT. Knowledge and use of ICT deeply helps teachers to solve the problem of the learner without directly intervening.

**The challenges of ICT in teaching and learning French as a foreign language**

Multimedia is the linchpin in a successful learning situation. So with the rise in the role of the teacher, it is necessary on his part that it is necessary to have training in the integration of the media in the language course. Managing a large class is difficult with the use of ICT. In the education system and with a fixed curriculum, ICTs play a "complementary role." Therefore there is marginal use of ICT in the language class. According to Mangenot "The integration [of ICT] is when the IT tool is used effectively at the service of learning." The simultaneous management of space and time in schools is a big problem with the integration of ICT. Communication skills are well developed with ICT, but writing restricts to secondary position. The student understands the accents well and practices them with new technologies. We observe that the learner refuses to write on paper using technology, so we have spelling mistakes. He prefers to speak in the target language and do role-plays.

**CONCLUSION**

To conclude, we can say that the methods of teaching and learning have evolved well with the insertion of ICT. But the teacher, the learner and the ICT must have a didactic and positive relationship. For years, the teacher has played a very important role in the teaching of the French language. Now the immersion of ICT has enhanced the status of teaching and teaching has become very creative and motivating. But we must not forget that it is still the effort and the competence of the teacher who balances the technology, the learner and the teaching.

**REFERENCES**

1. Barthélémy, Fabrice. Professor De Fle, Hachette, Paris, 2014.
2. Bertrand, Claude-Jean. The media in the language class? Not if ! Modern Languages No 5. Paris. Didier, 1980
3. Cuq, Jean-Pierre. Dictionary of teaching French as a foreign and second language, Paris, Clé International, 2003.
4. Devauchelle, Bruno. *How digital is transforming places of knowledge*, FYP Editions, 2012.
5. *French in the world. Research and Applications*, issue coordinated by Louis Porcher, "Self-learning", February-March 1992
6. *French in the world. Research and Applications*, number 420, "Teaching French to children", November 2018
7. Mangenot, F. The Integration of ICT in a Systemic Perspective, CLE Internationale, 2000
8. Martinez, P. The Didctic of Foreign Languages. What do i know? Paris: PUF
9. Tagliante, Christine. The Language Class, CLE International, 1994.
10. <http://www.theses.fr/2017UBFCC008>





**Shelly Bohra and Tanuja Yadav**

11. <https://journals.openedition.org/alsic/2826>
12. <https://www.google.com/url?sa=t&source=web&rct=j&url=http://www.univ-bejia.dz/dspace/>
13. [https://edutice.archives-ouvertes.fr/file/index/docid/275185/filename/Multimedia\\_Dispositifs\\_Maguy\\_Pothier\\_.pdf](https://edutice.archives-ouvertes.fr/file/index/docid/275185/filename/Multimedia_Dispositifs_Maguy_Pothier_.pdf)
14. [https://litere.uvt.ro/litere-old/vechi/documente\\_pdf/aticole/BELRom/AStanca.pdf](https://litere.uvt.ro/litere-old/vechi/documente_pdf/aticole/BELRom/AStanca.pdf)
15. <https://halshs.archives-ouvertes.fr/halshs-01066557>
16. [www.theses.fr/2010NANT3047](http://www.theses.fr/2010NANT3047)





## Combined Effect of Aqueous Extract of *Volvariella volvacea* and *Citrus limon* Juice for its Anti-Anemic and Anti-Thrombocytopenic Activities in Wistar Rats

Pant Hemant<sup>1</sup> and Jyothi.Y<sup>2\*</sup>

<sup>1</sup>Department of Pharmacology, Krupanidhi College of Pharmacy, Bangalore - 560035, Karnataka, India.

<sup>2</sup>Associate Professor, Department of Pharmacology, Krupanidhi College of Pharmacy, Bangalore - 560035, Karnataka, India.

Received: 06 Nov 2021

Revised: 12 Dec 2021

Accepted: 10 Jan 2022

### \*Address for Correspondence

Jyothi.Y

Associate Professor,

Department of Pharmacology,

Krupanidhi College of Pharmacy,

Bangalore - 560035, Karnataka, India.

Email: jokiran05@gmail.com,



This is an Open Access Journal / article distributed under the terms of the **Creative Commons Attribution License** (CC BY-NC-ND 3.0) which permits unrestricted use, distribution, and reproduction in any medium, provided the original work is properly cited. All rights reserved.

### ABSTRACT

Anemia is a common nutritional disease characterized by decrease in the hemoglobin and RBC content and thrombocytopenia is the condition in which the platelet counts decrease from the normal level, characterized by excessive bleeding from mouth, nose and gums. Aqueous extract of *Volvariella volvacea* contains flavonoid that shows anti-oxidant activity, anti-anemic activity and anti-thrombocytopenic activity where lemon juice help in the absorption of phytochemicals and mineral present in mushroom. The combination impact of *Volvariella volvacea* and lemon juice in PHZ-induced anemia and HIT in rats was studied in this study. The pulverized form of dried mushroom was subjected to aqueous extraction followed by phytochemical investigation and the anti-oxidant activity by DPPH method. Anemia was induced by PHZ 60mg/kg i.p for two days, and then treated with various doses of *Volvariella volvacea* alone and along with lemon juice at the dose of 200mg/kg, 400mg/kg and 10ml/kg p.o respectively for 14 days. Different parameters like RBC, WBC, Hgb, PCV, feed intake, and feed efficiency ratio were measured. Thrombocytopenia was induced with heparin 2000 IU/kg for 10 days, later treated with various doses of *Volvariella volvacea* alone and along with lemon juice at the dose of 200mg/kg, 400mg/kg and 10ml/kg p.o respectively for 14 days. The aqueous extract of *V. volvacea* has excellent anti-anemic and anti-thrombocytopenic activity. There is an increase in RBC, WBC, Hgb, PCV in comparison to PHZ induced positive control group, and also showed dose dependent increase in hematological parameters while given with lemon juice. The anti-anemic effect of *V. volvacea* might be attributed to the anti-oxidant potential of flavonoids, folic acid, and iron. In addition, *V. volvacea* showed excellent anti-thrombocytopenic activity. It showed marked increase in platelets and decrease in bleeding time and



**Pant Hemant and Jyothi**

increase in clotting time compared to heparin induced thrombocytopenic group. The anti-thrombocytopenic activity that could be due to its immunomodulatory activity of steroids present in mushroom. *Volvariella volvacea* extract possess good antioxidant activity, anti-anemic and anti-thrombocytopenic activity and it can be used as a drug of choice for both anti-anemic and anti-thrombocytopenia.

**Keywords:** Anemia, Thrombocytopenia, *Volvariella volvacea*, *Citrus limon*, Hemoglobin, Phenylhydrazine, Heparin.

**INTRODUCTION**

Anemia is a common blood disorder which affects the people of all ages and posing the great threat to global healthcare. Due to increased physiological demands for iron during development and pregnancy, as well as increased iron loss during menstruation, children, pregnant women, and non-pregnant women are more prone to iron insufficiency than other age groups [1,2]. Anemia affects 1.62 billion individuals worldwide, accounting for 34.8% of the population. Nine out of ten anemia sufferers live in developing countries [3]. Anemia is the common condition for the people of all developing countries because of, lack of nutrition like iron, folic acid, vitamin B12, proteins amino acids, vitamins A, C, and other vitamins of B-complex group like niacin and pantothenic acid are also involved in the maintenance of hemoglobin level [4]. The medical word for a low blood platelet count is thrombocytopenia. Platelets play an important role in blood clotting so its deficiency may leads to serious life threatening condition results from prolonged bleeding and clotting time [5]. Reduced platelet synthesis from bone marrow or increased platelet destruction, which is mostly driven by immunological response, genetic disorders, or infections like dengue hemorrhagic fever, parvovirus, rubella, and several bacterial infections like tuberculosis, cause a drop in normal platelet count [6]. Thrombocytopenia is a bleeding condition that causes both internal and exterior bleeding [7]. The most common cause of thrombocytopenia in India is dengue fever where high destruction of platelets and bone marrow suppression takes place [8,9].

*Volvariella volvacea*, often known as Chinese mushrooms, is widely grown in China and other Southeast Asian countries. *Volvariella volvacea* is found wild in the damp forest on the rotten wooden log, and currently, it is cultivated at the farm by using the damp paddy straw. So, it is also known as straw mushroom [10]. Water hyacinth, palm oil bunch water, pericarp water, banana leaves, and cotton waste are all used to commercially produce and nurture *V. volvacea* [11]. Volvatoxin, volvarin, and lectin are the main chemical substances identified from *V. volvacea* that have pharmacological effects in the human body. Potassium, phosphorus, magnesium, calcium, zinc, iron, and copper are among the minerals extracted from *Volvariella volvacea*. Crude protein, crude fibre, carbohydrate, ascorbic acids, and other nutrients are derived. It has the ideal property for treating several diseases due to the presence of the nutrients mentioned above and minerals, such as antimicrobial, anticancer, antioxidants, and antitumor [12]. The common name for the famous edible fruit of this tiny tree is lemon, which is a hybrid of the plant genus *Citrus*. Lemon is a Rutaceae family medicinal plant that originates in tropical and subtropical Southeast Asia. It's grown for its alkaloids, which have anticancer and antibacterial properties in crude extracts from various sections of the plant (viz., stem, root, leaves, and flower) It was reported that the plant contains various chemical constituents like sodium, water, potassium, magnesium, zinc, protein, vitamin C, phosphorus, fiber, fat, calcium, copper and iron [13,14]. Further the rich concentrations of iron, protein, zinc and vitamin C contributes to anti-anemic and anti-thrombocytopenic activities [15].

**METHOD AND METHODOLOGY**

The fresh Mushroom (*Volvariella volvacea*) and *Citrus limon* fruit were collected from the local market of Bangalore, Karnataka, India. The collected fresh mushroom was free of pesticides and other contaminants. The plant material



**Pant Hemant and Jyothi**

was identified and authenticated by Principal Scientist, Dr. P.E Rajasekharan, Department of Plant Genetic Resources.

**Plant extracts preparation**

The whole mushroom (*Volvariella volvacea*) was cut up and dried at room temperature in tiny pieces. It was grinded to a uniform powder and extracted by aqueous extraction method in rotary shaker for 48 hours at room temperature. The ratio of water to powdered mushroom was fixed at 1:10. Whatmann filter paper was used to filter it, and the filtrate was dried in a water bath. The extract was stored in clean sterile air tight container in a clean sterile area at 4 °C. The fresh lemon fruit was squeezed and stored in clean sterile container in a clean sterile area at 8-15 °C.

**Experimental Animals**

Sprague Dawley rats weighing 200±50g were kept in a well-ventilated animal housing at 25° ± 5°C with a 12:12 hour light-dark cycle. The Institutional Animal Ethics Committee authorized the experimental protocol. Prior to the nutritional modification, all of the rats were given a pellet diet and free access to water.

**Experimental Models****Induction of Anemia by Phenylhydrazine**

Giving Phenylhydrazine 60 mg/kg of body weight intraperitoneally for two days will cause anemia. The phenylhydrazine hydrochloride solution in 0.1M potassiumphosphate buffer, pH 7.4, was prepared in situ and filtered before use. This was then injected intraperitoneally for 2 days. Then the blood samples were withdrawn and tested to confirm the induction of Anemia.

**Collection of Blood Sample:** Under general anesthetics, blood was drawn from the rats through retro-orbital plexuses into an EDTA tube/Heparinized tube. In the past, using retro-orbital plexushas been a frequent procedure.

**Estimation of RBC using Haemocytometer:** Adequate amount of RBC diluting fluid was taken in a watch glass. In the RBC pipette, capillary blood was collected by sucking precisely up to 0.5 marking; the tip of the pipette was wiped. The diluting fluid for RBCs was sucked up to the exact amount of 101. The blood and fluid were carefully mixed to create an erythrocyte suspension. After 5 minutes, After the first few drops were discarded, the fluid was charged into the counting chamber by holding the pipette upright. It was allowed to settle for 2-3 minutes. The centers large square with 25 tiny squares were adjusted to light by switching to a low power (10X) objective. Now it is adjusted to high power (40X) objective. The four corner squares and one middle region were quantified for red blood cells.

No of RBCs/mm<sup>6</sup> = no. of cell counted X 200 X 400/80

**Estimation of hemoglobin by Sahli's hemoglobinometer (Acid hematin method):** N/10 HCL was placed in diluting tube up to the mark 20, and then blood is pipette up to 20 cubic mm mark and bowed into the diluting tube, and rinsed the pipette, after 10 minutes. Distilled water was added drop by drop until the color matches exactly to the standard. Then the reading that indicates the hemoglobin % is noted.

**Packed cell volume determination:** Blood was drawn from a rat tail that had been gently cut and allowed to flow through a capillary tube until it reached more than two-thirds of the tube, which was used to determine the rats' PCV. Plasticine was then used to seal the bleeding end. The capillary tubes were placed in the centrifuge and spun for 15 minutes at 3,000 rpm. The capillary tubes were placed on a micro hematocrit to measure the packed cell volume.

**Diet Efficacy:** Diet intake during the experiment was measured twice at the start and ending dates of administration, and weights were measured three times every 3 days during the experiment. The food efficiency ratio was computed by dividing the weight gained by the total amount of food consumed during the course of the study.



**Pant Hemant and Jyothi**

**Body weight:** One of the symptoms of anemia is loss in body weight so, the body weight of experimental animal is compared with the negative control group in order to identify either the mushroom extract is anti-anemic or not.

**Induction of Thrombocytopenia by Heparin**

Subcutaneous injections of low molecular weight heparin at a dosage of 2000 IU/kg were administered to rats every day for ten days, inducing platelet activation and thrombocytopenia in the animals.

**Determination of platelet count by Hemocytometry:** Fresh blood was directly pipette in a RBC pipette up to mark 0.5 mark and then diluting fluid is pipetted up to mark 101 was mixed by rolling the pipette in between palm for at least 5 minutes. The initial few drops were removed after 5 minutes by holding the pipette vertically, and the fluid was put into the counting chamber, which was maintained in a moist chamber for 30 minutes, allowing the platelets to settle down. Focus in the surface of the hemocytometer chamber with 10X objective and then focused under 40X and then dim light by adjusting the iris diaphragm and lower condenser. Counted the platelets in the entire center 1mm<sup>2</sup> (erythrocyte counting area) of each side of the chamber. The average counts of two sides were taken.

Platelet count/mm<sup>3</sup> = Number of cells counted X dilution factor / volume of fluid Where, volume of fluid for the 1 sq. mm area = 1 X 0.1 = 0.1 ml (mm<sup>3</sup>)

Dilution = 200

Platelet count/mm<sup>3</sup> = Number of cells counted X200/0.1

**Clotting time:** Blood was drawn into a capillary tube. To keep the capillary glass tube at body temperature, it is placed between the palms of both hands for 30 seconds. The tube was removed after 30 seconds, and a tiny bit of the capillary tube was broken at 30 second intervals until a thread of clotted blood appeared between the two segments of capillary glass tube. The time gap between the emergence of a blood drop and the thread of the blood clot was used to calculate the rat clotting time, which was measured in minutes.

**Bleeding time:** Determination of bleeding time: bleeding time was determined by modified duke's method. The animal was restrained and its tail was pulled out. The tip of the animal tail was pierced with a sterile needle and wiped on what man filter paper until the bleeding stopped. Bleeding time was recorded in terms of seconds.

**Statistical analysis:** All the result are presented as mean ± SEM. The significance of the difference relative to the positive control groups was assessed using graph pad prism version of one way analysis of variations (ANOVA). P value (P<0.05) where considered significant

**RESULTS**

The aqueous extract of the fungus (*Volvariella volvacea*) was made by mixing it 1:10 with water in a horizontal shaker for 48 hours and filtering it, yielding 3.45%. The extracts of the Mushroom (*Volvariella volvacea*) were found to be devoid of alkaloids after preliminary phytochemical screening. Aqueous extracts have also been shown to include carbohydrates, steroids, saponins, tannins, proteins, amino acids, and flavonoids. It was qualitatively observed that aqueous extract contain higher concentration of proteins and flavonoids component and selected this extract for further study

**In vitro Antioxidant activity**

*Volvariella volvacea* has DPPH radical scavenging activity. The extract improved free radical scavenging activity in a dose-dependent manner, according to the findings. The scavenging activity of the extract resulted in a significant increase in the suppression of DPPH radicals, according to the data. Free radical scavenging activity increased with increasing concentrations of the extract in the range of 25-250g/ml when compared to regular ascorbic acid (Table 1).



**Pant Hemant and Jyothi****Effect of aqueous extract of *V. volvacea* on body weight in phenylhydrazine induced anemia(PIA) rats.**

When comparing the body weight in experimental animal, the anemia-induced group (positive control group) injected with phenylhydrazine showed a significant decrease in body weight compared to that in the normal group ( $P<0.05$ ). The groups treated with mushroom extract and lemon juice showed a significant increase in body weight when compared with the control group.

**Effect of aqueous extract of *V. volvacea* on red blood cells in PIA rats**

The number on RBCs in the PHZ (phenylhydrazine) control group decreases when compared with the normal group ( $P<0.05$ ). The decrease number of RBC causes decreases in hemoglobin levels. The groups treated with mushroom extract and lemon juice for 14 days showed a significant increase in the number of RBCs when compared with the control group.

**Effect of aqueous extract of *V. volvacea* on Hemoglobin in PIA rats**

The mean hemoglobin (Hgb) content (g %) of rats in the PHZ (phenylhydrazine) control group decreases when compared with the normal group ( $P<0.05$ ). When compared to the control group, the groups treated with mushroom extract and lemon juice for 14 days exhibited a substantial rise in the number of hemoglobin levels equivalent to the normal group.

**Effect of aqueous extract of *V. volvacea* on packed cell volume in PIA rats**

The packed cell volume of rats in the PHZ (phenylhydrazine) control group decreases when compared with the normal group ( $P<0.05$ ). The groups treated with mushroom extract and lemon juice for 14 days showed a significant increased PCV in similar to normal group when compared with the control group.

**Diet efficiency of the animals**

When compared to the normal group, the control group exhibited a substantial decrease in feed consumption after the trial. The groups treated with mushroom extract and Lemon juice showed increase in the intake of feed as that of the normal group (Table 2).

**Effect of aqueous extract of *V. volvacea* on platelets in Heparin Induced Thrombocytopenia (HIT) rats**

The number on platelets in the heparin induced thrombocytopenia control group decreases when compared with the normal group ( $P<0.05$ ). When compared to the control group, the groups treated with mushroom extract and lemon juice for 14 days exhibited a substantial rise in platelet count equivalent to the normal group.

**Effect of aqueous extract of *V. volvacea* on clotting time in HIT rats**

The time of clotting in the heparin induced thrombocytopenia control group increases when compared with the normal group ( $P<0.05$ ). When compared to the control group, the groups treated with mushroom extract and lemon juice for 14 days exhibited a substantial reduction in bleeding time, similar to the normal group.

**Effect of aqueous extract of *V. volvacea* on bleeding in HIT rats**

The time of bleeding in the heparin induced thrombocytopenia control group increased when compared with the normal group ( $P<0.05$ ). The groups treated with mushroom extract and lemon juice for 14 days showed a significant decreased in the time of bleeding similar to normal group when compared with the control group (Table 3).

**DISCUSSION**

The goal of this study was to see how an aqueous extract of *V.volvacea* mixed with lemon juice affected anaemia caused by Phenylhydrazine and thrombocytopenia caused by Heparin in Sprague Dawley rats. Initially, the aqueous extract was utilized for phytochemical research, which revealed the presence of flavonoids, proteins, folic acid, and steroids, among other secondary metabolites [16]. In addition, the aqueous extract of *V. volvacea* showed DPPH (1,diphenyl-2-picrylhydrazyl) free radical scavenging activity with an IC50 value of 49 g/ml, compared to 30 g/ml for regular ascorbic acid. According to this study, the antioxidant effects are due to the presence of flavonoids. In this





**Pant Hemant and Jyothi**

study significant ( $P < 0.05$ ) decreases in hemoglobin, RBC, WBC and PCV when compared to control was observed after injection on experimental animals with PHZ. When treating with aqueous extract of *V. volvacea* along with lemon juice for 14 days there was increase in RBC count, WBC count, and PCV count and also in feed intake compared to rat only given aqueous extract of *V. volvacea*. In this present study the RBC and Hgb content may be increased due to recovery from free radical damage caused by PHZ by the antioxidant activity of aqueous extract of *V. volvacea* and effect of lemon juice helping in the absorption of iron, vitamins and several minerals present in *V. volvacea*. The aqueous extract of *V. volvacea* revealed significant free radical scavenging activity [17].

After treating with aqueous extract of *V. volvacea* along with lemon juice for 14 days there was increase in body weight ( $193.33 \pm 2.47$ ), RBC ( $6.485 \pm 0.19$ ), WBC ( $8.34 \pm 0.13$ ), Hgb ( $8.43 \pm 0.28$ ), and PCV ( $38.73 \pm 1.85$ ). Lastly the anti-thrombocytopenic activity was assessed like platelet count, bleeding time and clotting time through heparin induction model. Heparin-induced thrombocytopenia (HIT) is a common drug-induced autoimmune condition characterized by arterial and venous thromboembolism. Immune complexes including antibodies to platelet factor 4 (PF 4), heparin, and immunoglobulin G (IgG) (IgG). 18 HIT is induced by antibodies that recognize a molecule made composed of heparin and platelet factor 4 (PF 4) tetramers [19]. Also, while the treatment was given with the drug, there was a remarkable improvement that was observed as far as the physical characteristics were also concerned. The most possible mechanism of action of the drug, for management of thrombocytopenia may be by inhibiting the activity of anti-thrombin or else by stopping the inhibition of the clotting factors X and IXa or it may be also through the increase in platelet count [20-23]. After treating with aqueous extract of *V. volvacea* along with lemon juice there is an increase in the platelets count ( $622.33 \pm 10.151$ ) and there is a decrease in bleeding time ( $60.83 \pm 2.21$ ) and clotting time ( $134.66 \pm 2.77$ ) when it is compared with the animals given *V. volvacea* alone. Dengue fever can be prevented using *V. volvacea*. Dengue fever is a viral infection that causes rapid platelet loss. *V. volvacea* possesses anti-viral activity and it increases the platelets count by its immunomodulatory action.

**CONCLUSION**

In conclusion, from phytochemical screening study, aqueous extract of *V. volvacea* showed the presence of sterols, proteins, flavonoids and several minerals and showed dose dependent increase in antioxidant activity in DPPH radical scavenging activity. Both the doses; low and high dose of *V. volvacea* along with the lemon juice showed significant increase in high RBC, Hemoglobin, Packed volume and body weight as compared to the control group through several mechanism. Different doses of *V. volvacea* along with lemon juice also showed marked increase in platelet count and decrease in bleeding and clotting time compared to animals given only *V. volvacea*. As a consequence, the findings of this study show that both high and low doses of aqueous extract of *V. volvacea* mushroom have antioxidant, anti-anemic, and anti-thrombocytopenic properties.

**ACKNOWLEDGEMENT**

It gives me immense pleasure to acknowledge, the help rendered to me by a host of people to whom I owe gratitude in completion of my project work, all those who have encouraged and supported me throughout the project work. The work cited in this dissertation would not have been possible without the blessings of almighty. I would like to express my gratitude to my family for their endless support and love without which it would not have been possible for me to complete the work.

**REFERENCES**

1. De Maeyer EA, Adiels-Tegman M. The prevalence of anemia in the world. World health statistics quarterly 1985; 38 (3): 302-316. 1985.
2. Kaur K. Anemia 'a silent killer 'among women in India: Present scenario. European Journal of Zoological Research. 2014;3(1):32-6.



**Pant Hemant and Jyothi**

3. Toteja GS, Singh P. Micronutrient profile of Indian population. Indian Council of Medical Research; 2004.
4. Saravanan VS, Manoharan S. Anti-anemic activity of some plants in Cucurbitaceae on phenylhydrazine-induced anaemic rats. Thai J Pharm Sci. 2012 Oct 1;36(4):150.
5. Richard Lee G, Foerster J, Lukens J, Paraskevas F, Greer JP, Rodgers GM. Wintrobe's clinical hematology.
6. Nerumalla CS, Shah AA. A case of thrombocytopenia associated with valproic Acid treatment. The primary care companion for CNS disorders. 2013;15(4).
7. Visentin GP, Liu CY. Drug-induced thrombocytopenia. Hematology/oncology clinics of North America. 2007 Aug 1;21(4):685-96.
8. Greenberg EM, Kaled ES. Thrombocytopenia. Critical Care Nursing Clinics. 2013 Dec 1;25(4):427-34.
9. Lei HY, Yeh TM, Liu HS, Lin YS, Chen SH, Liu CC. Immunopathogenesis of dengue virus infection. Journal of biomedical science. 2001;8(5):377-88.
10. Alexis DS. Study of the Fungus *Volvariella volvacea* (Bull.) Singer Composition, A Non-Timber Forest Product (NTFP) Food Purchased at Abidjan Markets in Ivory Coast. SF J Mycology. 2018;2(1).
11. Bao D, Gong M, Zheng H, Chen M, Zhang L, Wang H, Jiang J, Wu L, Zhu Y, Zhu G, Zhou Y. Sequencing and comparative analysis of the straw mushroom (*Volvariella volvacea*) genome. PloS one. 2013 Mar 19;8(3):e58294.
12. Eguchi F, Kalaw SP, Dulay RM, Miyasawa N, Yoshimoto H, Seyama T, Reyes RG. Nutrient composition and functional activity of different stages in the fruiting body development of Philippine paddy straw mushroom, *Volvariella volvacea* (Bull.: Fr.) Sing. Advances in Environmental Biology. 2015 Sep 1;9(22 S3):54-66.
13. Chaudhari SY, Ruknuddin G, Prajapati P. Ethno medicinal values of Citrus genus: A review. Medical Journal of Dr. DY Patil University. 2016;9(5):560
14. Fernandez-Lopez JA, Lopez-Roca JM, Almela L. Mineral composition of iron chlorotic Citrus limon L. leaves. Journal of plant nutrition. 1993;16(8):1395-407.
15. Pandey S, Ganeshpurkar A, Bansal D, Dubey N. Hematopoietic effect of *Amaranthus cruentus* extract on phenylhydrazine-induced toxicity in rats. Journal of dietary supplements. 2016;13(6):607-15.
16. Bhandary SK, Bhat VS, Sharmila KP, Bekal MP. Preliminary phytochemical screening of various extracts of Punica granatum peel, whole fruit and seeds. Journal of Health and Allied Sciences NU. 2012 Dec;2(04):34-8.
17. Miliuskas G, Venskutonis PR, Van Beek TA. Screening of radical scavenging activity of some medicinal and aromatic plant extracts. Food chemistry. 2004 Apr 1;85(2):231-7.
18. Gannett PM, Shi X, Lawson T, Kolar C, Toth B. Aryl radical formation during the metabolism of arylhydrazines by microsomes. Chemical research in toxicology. 1997 Dec 16;10(12):1372-7.
19. Amer J, Goldfarb A, Fibach E. Flow cytometric analysis of the oxidative status of normal and thalassemic red blood cells. Cytometry Part A: the journal of the International Society for Analytical Cytology. 2004 Jul;60(1):73-80.
20. Zucker MB, Katz IR. Platelet factor 4: production, structure, and physiologic and immunologic action. Proceedings of the Society for Experimental Biology and Medicine. 1991 Nov;198(2):693-702.
21. Akanksha B, Avijit M, Chakraborty GS, Seema G. PHYTOPHARMACOLOGICAL USES OF TEPHROSIA PURPUREA-A REVIEW. Pharmacophore. 2014;5(4):658- 65.
22. Lee GM, Arepally GM. Heparin-induced thrombocytopenia. Hematology 2013, the American Society of Hematology Education Program Book. 2013 Dec 6;2013(1):668- 74.
23. Rauova L, Zhai L, Kowalska MA, Arepally GM, Cines DB, Poncz M. Role of platelet surface PF4 antigenic complexes in heparin-induced thrombocytopenia pathogenesis: diagnostic and therapeutic implications. Blood. 2006 Mar 15;107(6):2346-53.





## Pant Hemant and Jyothi

Table 1: *In vitro* Antioxidant activity

SL. No	Conc. in µg/ml	Percentage inhibition by standard Ascorbic acid	Percentage inhibition by <i>Volvariella volvacea</i>
1	25	48.21	41.36
2	50	51.18	44.51
3	100	60.97	55.29
4	150	74.65	68.02
5	200	84.64	72.86
6	250	92.82	81.04
	IC50	30.09	49.57

Table 2: Diet efficiency of the animals

TREATMENT GROUP	Body weight (gm)	RBC	Hemoglobin (gm)	Packed Cell Volume	Feed intake (gm)
Normal group	195.00±2.58	6.36±0.117	9.53±0.14	38.78±1.24	19.00±0.44
Positive Control group (PHZ 60mg/kg for 2 days)	165.00±1.825	5.41±0.164	6.51±1.43	26.80±2.21	18.00±0.57
Low dose of <i>V. v</i> (200mg/kg for 14 days)	178.33±2.10a	5.73±0.127a	7.26±0.35a	30.92±2.14a	18.30±0.42a
High dose of <i>V. v</i> (400mg/kg for 14 days)	185.00±1.82	5.99±0.111	7.61±0.50b	34.72±1.97b	21.00±1.12
Low dose of <i>V. v</i> with <i>L. j</i>	190.00±3.27b	6.33±0.161b	7.85±0.55	37.73±1.52	22.50±0.88b
High dose of <i>V. v</i> with <i>L. j</i>	193.33±2.47c	6.485±0.19c	8.43±0.28c	38.73±1.85c	22±1.23c
Lemon juice Only	180.86±1.74	6.24±0.24	7.3±0.37	29.74±1.24	19.83±0.83

n=6 Statistical significance of the results was tested by comparing treatment groups with the control group by applying one-way ANOVA followed by Dunnett's test value a, b, c P<0.05.

Table 3: Effect of aqueous extract of *V. volvacea* on bleeding in HIT rats

TREATMENT GROUP	Platelets	Clotting time (sec)	Bleeding time (sec)
Normal group	720.50±13.36	122.30±1.085	64.50±0.76
Positive Control group (Heparin 2000IU for 10days)	404.00±6.77	172.50±1.33	96.50±1.11
Low dose of <i>V. v</i> (200mg/kg for 14 days)	524.50±7.40	154.30±1.22	66.50±0.76
High dose of <i>V. v</i> (400mg/kg for 14 days)	580.00±4.92b	132.83±0.94	61.50±0.99
Low dose of <i>V. v</i> with <i>L. j</i>	617.00±16.09	131.50±0.76b	59.50±1.08b
High dose of <i>V. v</i> with <i>L. j</i>	622.33±10.151c	134.66±2.77c	60.83±2.21c
Lemon juice only	406±6.98a	126.83±3.102a	56.16±1.81a

n=6 Statistical significance of the results was tested by comparing treatment groups with the control group by applying one-way ANOVA followed by Dunnett's test value a, b, c P<0.05





## A Study on Employee Engagement Dimensions with Reference to IT Sector in Chennai City

T.A.M. Hameed Kan\*

Associate Professor, MEASI Institute of Management, Chennai, Tamil Nadu, India.

Received: 03 Nov 2021

Revised: 18 Dec 2021

Accepted: 12 Jan 2022

### \*Address for Correspondence

**T.A.M. Hameed Kan**

Associate Professor, MEASI Institute of Management,  
Chennai, Tamil Nadu, India

Email: hameedkan@gmail.com



This is an Open Access Journal / article distributed under the terms of the **Creative Commons Attribution License** (CC BY-NC-ND 3.0) which permits unrestricted use, distribution, and reproduction in any medium, provided the original work is properly cited. All rights reserved.

### ABSTRACT

Global sourcing continues to grow at a faster rate in India than in the IT-BPM industry. India is the world's largest sourcing destination, accounting for about 55% of the Approximately USD 200-250 billion annual services sourcing industry in 2019-20. In 2020, the IT industry will contribute 8% of India's GDP. Exports from India's information technology sector are predicted to expand by 1.9 per cent to US \$ billion in FY21. The continuous improvements in technology have resulted in a 13.4 percent year-on-year growth in the India IT and software sector compared to 2019. During the curfew period, when residents were prohibited from leaving their houses, information technology (IT) aided in the preservation of residents' lifestyles. From grocery shopping to online classes through telemedicine, it increased efficiency in every aspect of everyday human existence. Even during periods of economic distress, the Indian government relied on the IT & software sector to maintain socioeconomic growth in 2021. The primary purpose of research is to evaluate the relationship between employee engagement and performance in information technology enterprises in Chennai. The descriptive research approach was used, and data were collected from 95 workers of IT companies in Chennai to determine their level of engagement. The study's findings indicate a significant relationship between workplace autonomy and its effect on employee motivation.

**Keywords:** Workplace Autonomy, Employee Motivation, Performance Management and organization outcomes.

### INTRODUCTION

As a result of COVID-19's global influence, two fundamental developments have occurred: a rapid acceleration of digital transformation and the evolution of the workforce into a hybrid prototype. The epidemic has accelerated the adoption of technology by businesses as well as by consumers. Even sectors that were not previously influenced by



**Hameed Kan**

information technology have transitioned from physical to digital. Lifting expenditure constraints on IT software and services, CRM, collaboration, cloud computing, artificial intelligence, automation, and other areas will be the drivers of investment opportunities during the pandemic, which will help to accelerate the share of the Indian IT industry. During the pandemic, the Indian IT industry is projected to expand at a faster rate. Despite the epidemic, the Indian information technology sector is showing signals of growth. However, the business must face several challenges. The second wave of COVID has harmed IT firms' operational capacities and business continuity due to the infections that have impacted their workforce during this period. This needs additional personnel to increase capacity and provide required infrastructure, medical equipment, medications, and other resources for affected workers before the situation deteriorates further. The primary goal of the research study is to determine the most critical factor that influences employee engagement in the software industry in Chennai City. The study's findings revealed that equality and diversity of the firm, culture and team spirit, distraction-free workplace culture, job security, and Motivation in the workplace are the most significant elements in contributing to employee engagement in software companies.

**Review of Literature**

Forson, J. A., et al. (2021) examine the association between job motivation elements and effectiveness among teachers in elementary schools in Ghana. The study takes a quantitative approach using a sample of 254 instructors from a community of 678 in Ghana's Effutu Municipality, of which 159 surveys were completed correctly and returned, reflecting a return rate of 62.6 percent. Using multiple linear regression analysis and ANOVA, the study discovers that the remuneration package, work design and atmosphere, and performance review play a significant role in determining teacher motivation in the town. Thus, when performance was regressed at deconstructed and aggregated levels, these motivation components were significant predictors of performance. These findings are consistent with the identity theory, more precisely with the explanations offered for the controllable and autonomous motivation aspects. The study recommends that the municipal director of education allow young prospective teachers and interns in their formative years to be hired to supplement the experienced staff. More should be done to empower the profession to exercise autonomy in fulfilling its responsibilities to cultivate the next generation of inventive educators in the municipality. Almawali, H. et al. (2021) analyses the relationship between employee motivation, work performance, and employee engagement in the Sultanate. 111 Ministry of Education personnel were utilized in a quantitative study to test six assumptions. This study uses quota sampling, SPSS, and path analysis approaches. The study's findings show that motivating factors positively correlate with work engagement and work performance and that employee engagement functions as a possible mediator in this relationship. This study is vital for executives and regulators seeking to improve work performance in Oman.

Ismael, F and Yesiltas, M (2020) established a theory of moderation and mediation to better understand the impact of CSR on job engagement and organizational behaviour. This study focuses on Iraqi employees, with primary data collected through a structured questionnaire completed by 524 people. The study focused on employee perceptions of several components of CSR and its impact on work, work engagement, and organizational citizenship behaviour. Structural equation modelling, a mixture of multiple linear regression and factor analysis, were used to analyze the data. The study's outcomes clearly show that the elements of corporate socially responsible have a significant positive impact on organizational citizenship behaviour and employee engagement. Furthermore, work engagement has a direct effect on organizational citizenship behaviour and job satisfaction. In contrast, job satisfaction has a specific relationship with organizational citizenship behaviour and a mediating effect on the relationship between staff engagement and organizational citizenship behaviour. Tuin, L. V et al (2020) examined a company goal and vision that matched the concept of a higher purpose. The first research (N = 270) used self-reporting. The second study used a cross-lagged panel design to model goal, motivation, and engagement over three-time points (N = 56). The purpose was linked to motivation and engagement. It was confirmed that purpose leads to engagement but not inspiration. Despite the cross-sectional study's considerable correlation between purpose and reason, the relationship between purpose and basis remains complex. With the current spike in interest in aim as a tool for sustainable business, the recent review adds to the body of information on the topic.



**Hameed Kan**

Tikku, S., & Verma, T. (2019) sought to investigate the predictors of employee engagement at work. The hypothesis was built on prior research that employees' mood and energy levels in their places of employment would reflect their level of engagement at their jobs. It comprised 120 younger workers from private organizations, divided equally between 60 men and 60 women between the ages of 23 and 35. Their responses were collected by completing three questionnaires: the Maslach Burnout Inventory, the Utrecht Work Motivation Scale, and the Beck Depression Inventory. It was shown that depression was connected with lower levels of burnout and lower levels of workplace engagement. There was a negative relationship between factors that contributed to burnout and factors that contributed to work arrangement. Any of the tested variables did not show any difference in response between men and women. Depression and cynicism indicated only vigour, but professional efficacy predicted all aspects of work engagement. But energy did not expect emotional tiredness; instead, it stated devotion and immersion. It was determined that destructive emotion is only a predictor of one dimension of job involvement and that this is the case in this study. However, professional efficacy is the most critical predictor since it has a favourable impact on work involvement.

**Need for The Study**

The COVID-19 epidemic has exerted an unprecedented burden on firms' ability to keep people engaged during times of stress and uncertainty. After Covid19, most companies recognize that a contented employee isn't always the most loyal or productive. To be an "engaged employee," one must have a solid intellectual and emotional connection to the organization's aims. These are behaviours that drive the business, not just essential job duties. Companies must specialize in engaging people to drive performance for survival, development, and greatness. Retaining and engaging talented employees is no longer enough. The study will assist the company identify employee engagement levels and improve employee happiness and retention.

**Statement of the Problem**

The Indian IT industry has helped India gain global recognition. The IT sector in India has become a significant contributor to economic progress. India's IT potential is steadily boosting defence capabilities, tackling energy and environmental concerns, among others. Compared to the development of other industries in Chennai, the IT industry's growth has been exceptional. The problems for Hr practitioners in the IT industry range from sustaining productivity and profitability to attracting, motivating, and retaining outstanding people. Active personnel are essential for surviving in the competitive IT market. Thus, the present study examines many variables of employee engagement in Chennai IT firms.

**Objective of the study**

- To investigate the level of association between the firm's cultural diversity and employee career opportunities in IT companies.
- To explore the relationship between workplace autonomy and employee motivation in IT companies.
- To determine the most dominating element impacting employee engagement in Chennai's IT companies.

**Scope of the study**

The survey is limited to employees who work in the information technology sector in Chennai. The results of the study will assist the company in understanding the current levels of engagement among its personnel. It can enable them to take the necessary activities to interact with people more productively, improve their citizenship behaviour and satisfaction, and reduce their desire to leave the organisation. There is a strong interest in determining the relationship between organisational commitment and employee job satisfaction. Transformational leadership and organizational behaviour, intention to quit and job performance are also on the agenda for investigation.





Hameed Kan

## RESEARCH METHODOLOGY

The current study employed a descriptive research approach, with data obtained from 95 workers working in information technology organisations in Chennai by random sampling. Statistical tools were used to exam study hypotheses, established using a questionnaire method and a five-point Likert scale that extended from strongly agree to strongly disagree.

### Data Analysis and Results

#### Chi-Square Test

Hc: There is no association difference between the employees age and culture of teamwork among the employees.

**Inference:** Using the Pearson Chi-Square test, it is discovered that the value is 0.320, which is larger than 0.05. In this case, the negative hypothesis is accepted, indicating no significant association between age and the culture of teamwork among the employees

#### Correlation Analysis

Hc: There is no significant relationship between autonomy of the work place and its impact on employee motivation

**Inference:** The Pearson correlation coefficient  $r$  is 0.706, indicating a positive and significant association between workplace autonomy and employee motivation. As a result, the correlation between the two variables is in a positive direction

#### Friedman Test

Hc: There is no significant difference between the mean rank towards the dominating factor influencing employee engagement in IT companies.

**Inference:** It is discovered that the  $p$  value is less than 0.05. The null hypothesis should be rejected at the significance level of 0.05. As a result of the Friedman test, it was determined that there is a statistically significant difference in the mean rank and the dominant factor impacting employee engagement in information technology businesses

#### Multiple regression analysis

The dependent variable is Employee Engagement(Y) of the client, and Independent variables are Workplace culture (X1), career(X2), Autonomy(X3) and Inspiration (X4). The relationship is shortly estimated through multiple regression analysis, and the results are presented below. The MRA table shows that R Square Value is 0.174 and adjusted R Square is 0.137 with the standard error of estimate as 2.4764. It implies that all the independent variables explain 1.74%, and regression fit is verified in the following ANOVA table.

#### ANOVA<sup>a</sup>

The MRA table shows that  $f = 4.739$ ,  $p = 0.002$  are statistically significant at 5% level. This implies that the regression fit is significant and concludes that the cumulative influence of independent variables on reliability is statistically significant. Hence the independent influence of these variables on reliability is analysed in the following table:

The partial effect of Inspiration on Employee Engagement is shown by the X4 coefficient of 0.071. The predicted positive sign means that for every unit rise in Inspiration, Employee Engagement increases by 0.071. This coefficient is significant at 1%. Assuming the other variables are constant, the X2 coefficient is 0.018. The predicted positive sign means that for every unit rise in career, Employee Engagement increases by 0.018. This coefficient is significant at 1% level.



**Hameed Kan****Suggestion and Recommendation**

The following are suggestions that, if applied, may be beneficial to the organisation to improve the current Employee Engagement Level and make it a more productive one.

- It is proposed that IT businesses should have regular dialogues with team members, which can help them detect early levels of fear and create more excellent room for receiving and making suggestions throughout this time. Furthermore, the corporations should Organization as it leads video or audio chats with coworkers and sends emails, is an excellent means of remaining connected. It's also a good idea to keep the dialogue focused on safety and health first, before moving on to job and business later.
- It is recommended that IT firms improve the welfare of employees and provide upskilling chances to employees through online courses and webinars, announce wellness initiatives concentrating on the mental health and fitness of employees, and provide additional leave for employees to use for their care or the care of their loved ones. Trust and resilience are fostered among employees through such programmes, enabling them to tackle a changing environment's challenges and prepare enterprises for the future.
- It is recommended that the organisation establish an Executive Oversight team to govern organisational change goals, provide criteria for evaluating change success, and assign accountability for specific roles and activities.

**CONCLUSION**

Employee engagement is now considered a vital aspect of business success. Organizations may raise and improve employee engagement. So the company must regularly check it. This necessitates more research into employee engagement, the factors that influence it, and the benefits to IT firms. The study concluded that rewards and recognition, as well as leadership behaviours, affect employee engagement. Engaging employees requires fair compensation, participative management, and acceptance of employee thoughts and proposals. Appreciation for work done encourages and engages workers

**REFERENCES**

1. Abeyrathna, S. P. G. M. 2020. Determinants of Moonlighting Decisions among Government Employees in Sri Lanka: Evidence from Government Employees who Dwelt in Kegalle District. *International Journal of Scientific and Research Publications*, 10(12).
2. Ahmad, Y., Amiartuti, K., & Riyadislamet. 2020. The Effect of Competence, Work Life Balance, and Perceived Value on Employee Engagement, Employee Trust, and Employee Performance in Pharmaceutical Wholesaler Companies in South Kalimantan Province. *IOSR Journal of Business and Management*, 22(12), 35-41.
3. Almawali, H., Hafit, N. I. A., & Hassan, N. 2021. Motivational Factors and Job Performance: The Mediating Roles of Employee Engagement. *International Journal of Human Resource Studies*, 11(3), 67-82.
4. Arunachalam, T. 2019. Role of Organizational Climate and Organizational Justice in Predicting Employee Engagementa Organizational Citizenship Behavior. *International Journal of Indian Psychology*, 7(4), 295-305.
5. Dlouhy, K., & Casper, A. 2021. Downsizing and Surviving Employees' Engagement and Strain: The Role of Job Resources and Job Demands. *Human Resource Management*, 60(3), 435-454.
6. Enkhbaatar, S., Gurbazar, B., & Choijil, B. 2021. X and Millennial Employee Job Satisfaction Factor Study of Mongolia. *Journal of Human Resource and Sustainability Studies*, 9(2), 159-172.
7. Forson, J. A., Ofosu-Dwamena, E., Opoku, R. A., & Adjavon, S. E. 2021. Employee Motivation and Job Performance: A Study of Basic School Teachers in Ghana. *Future Business Journal*, 7(1)
8. Islam, M. N., Idris, A., & Furuoka, F. 2021. Dynamic Forces of Amplifying Employee Change Supportive Behavior: An Individual-Level Analysis. *International Journal of Asian Business and Information Management*, 12(3), 1-18.
9. Ismael, F., & Yesiltas, M. 2020. Sustainability of CSR on Organizational Citizenship Behavior, Work Engagement and Job Satisfaction: Evidence from Iraq. *Review of Research and Social Intervention*, 71, 212-249.







**Hameed Kan**

10. Naintara, Bhutta, Z. M., & Zafar, S. 2019. Impact of HRM Practices on Employee Engagement: Evidence from Banking Sector of Pakistan. *NUML International Journal of Business and Management*, 14(2), 140-155.
11. Saether, E. A. 2019. Motivational Antecedents to High-Tech R&d Employees' Innovative Work Behavior: Self-Determined Motivation, Person-Organization Fit, Organization Support of Creativity, and Pay Justice. *Journal of High Technology Management Research*, 30(2), 100350.
12. Staples, R., & Whittall, M. 2021. The Dilemma of Social Media for German Work Councils Representing Qualified Employees—the Case of a German Car Manufacturer. *New Technology, Work and Employment*, 36(2), 140-158.
13. Sundstrup, E., Seeberg, K. G. V., Bengtsen, E., & Andersen, L. L. 2020. A Systematic Review of Workplace Interventions to Rehabilitate Musculoskeletal Disorders among Employees with Physical Demanding Work. *Journal of Occupational Rehabilitation*, 30(4)
14. Tikku, S., & Verma, T. 2019. Predictors of Work Engagement: Mood and Energy as Essential Determinants of Healthy Engagement with Work. *International Journal of Indian Psychology*, 7(4), 311-322.
15. Tuin, L. V., Schaufeli, W. B., Broeck, A. V. D., & Rhnen, W. V. 2020. A Corporate Purpose as an Antecedent to Employee Motivation and Work Engagement. *Frontiers in Psychology*, 11
16. Venu, S. 2021. A Study of Impact on Performance Appraisal on Employee's Engagement in an Organization. *Anveshana's International Journal of Research in Regional Studies, Law, Social Sciences, Journalism and Management Practices*, 6(2), 23-37.
17. Wacker, E., Fischer, A., & Schorlemmer, J. 2021. Person-Environment Fit, Burnout and Work Engagement. *Zentralblatt für Arbeitsmedizin, Arbeitsschutz und Ergonomie*, 71(4)
18. Yajnya Dutta Nayak, S. R. S. 2021. Impact of Organization Culture on Employee Engagement in Service Sector of India. *Journal of Social Welfare and Management*, 12(4), 131-136.
19. Zhang, J., Ul-Durar, S., Akhtar, M. N., Zhang, Y., & Lu, L. 2021. How does Responsible Leadership Affect Employees' Voluntary Workplace Green Behaviors? A Multilevel Dual Process Model of Voluntary Workplace Green Behaviors. *Journal of Environmental Management*, 296, 113205.

**Table 1. Chi-Square Test**

Particular	Value	P Value	Degree of freedom
Pearson Chi-Square	7.006 <sup>a</sup>	.320	6
Likelihood Ratio	8.083	.232	6
Linear-by-Linear Association	5.665	.017	1
N of Valid Cases	95		

**Table 2. Correlation Analysis**

Particular	Total Inspiration
Total Autonomy	.706**
Sig. (2-tailed)	0.000
N of Valid Cases	95

**Table 3. Friedman Test**

Factors influencing Engagement of the Employees	Mean Rank Value
Total_Cultural	3.81
Total_career	2.36
Total Autonomy	2.03
Total_Inspiration	1.81
Chi-Square	151.912
Asymp. Sig.	0.00





**Hameed Kan**

**Table 4. Model Summary**

Model	R	R Square	Adjusted R Square	Std. Error of the Estimate
1	.417 <sup>a</sup>	.174	.137	2.47684

**Table 5. ANOVA<sup>a</sup>**

	Model	Sum of Squares	df	Mean Square	F	Sig.
1	Regression	116.293	4	29.073	4.739	.002 <sup>b</sup>
	Residual	552.128	90	6.135		z
	Total	668.421	94			

**Table 6. Coefficients<sup>a</sup>**

Model		Unstandardized Coefficients		Standardized Coefficients	t	Sig.
		Beta	Std. Error	Beta		
1	(Constant)	8.634	1.439		6.002	.000
	Cultural	-.017	.126	-.017	-.138	.891
	Career	.018	.102	.021	.173	.863
	Autonomy	.283	.104	.359	2.717	.008
	Inspiration	.071	.127	.083	.561	.576





## A Review on Endophytic Microbes

Ruchika Yadav<sup>1\*</sup>, Anuradha Singh<sup>2</sup>, Nupur Mathur<sup>2</sup> and Veena Yadav<sup>1</sup>

<sup>1</sup>Research Scholar, EMM Lab, Department of Zoology, University of Rajasthan, Jaipur- 302004, India.

<sup>2</sup>Professor, EMM Lab, Department of Zoology, University of Rajasthan, Jaipur- 302004, India.

Received: 08 Dec 2021

Revised: 22 Dec 2021

Accepted: 17 Jan 2022

### \*Address for Correspondence

**Ruchika Yadav**

Research Scholar,

EMM Lab, Department of Zoology,

University of Rajasthan,

Jaipur- 302004, India.

Email: ruc.yadav@gmail.com



This is an Open Access Journal / article distributed under the terms of the **Creative Commons Attribution License** (CC BY-NC-ND 3.0) which permits unrestricted use, distribution, and reproduction in any medium, provided the original work is properly cited. All rights reserved.

### ABSTRACT

Endophytes are plant associated micro-organisms that reside in the inner tissues of plant parts. All plants studied till date are inhibited by diverse microbial community which consists of bacteria, fungi and archaea. Mostly endophytes originate from the rhizosphere or phyllosphere but some are transmitted through the seed also. Endophytes can promote plant growth by two mechanisms either direct or indirect. Direct plant growth promotion is usually caused by phytostimulation and biofertilization. Indirect plant growth promotion occurs when there is some pathogen, pollutants or some other stress condition. The interaction between plants and endophytes depends on different factors like plants' genetics, microbial genetics and environmental conditions etc. These diverse endophytes play a principle role in ecosystem, plant development, growth and fitness.

**Keywords:** Endophytes, Phytostimulation, Biofertilization, Rhizosphere, Phyllosphere

### INTRODUCTION

Plants live in association with many microorganisms. One group of these microorganisms is endophytes. The word endophyte came from two Greek words "endon" means within, and "phyton" means plant. Hence defined literally microorganisms that are present inside the plant or at least spend some part of their life cycle inside the plant are called endophytes. They utilize the internal environment of the plant as a unique ecological niche which shields them from changes in the environment. Endophytes were first described by a German naturalists and botanist Heinrich Friedrich Link in 1809 [1]. He described endophytes as a distinct group of partly parasitic fungi living in plants. Other than the infectious microorganisms, the presence of non-pathogenic organisms inside the plants was first noticed by De Bary [1866] and he provided the first definition of an endophyte, as "any organism that grows within plant tissues are termed as endophytes" [2]. The first endophyte was isolated from *Lolium temulentum* by Freeman in 1904. Earlier, the term endophyte has generally been used for fungi present inside the plants but with time

38350



**Ruchika Yadav et al.**

researchers realized that plants can be colonized with bacteria as well. With the years the endophyte definition has been revised multiple times. Petrini [1991] defined endophytes as any organism that spend some part of its life cycle, inside the plant tissues without causing any type of harm to the host plant [3]. This relationship of plant host and endophytes have formed as a result of hundreds of millions of years of evolution. They can be transmitted through plant generations, as an integral part of the plant organism, endosphere.

Diverse endophytes are essential part of ecosystems and plant physiology. Presence of different endophytic community is highly variable and the causes for this variability is difficult to determine because it depends on interplay of many factors. For example, the nature of plant host species [4], its geographical location, age, genotype, the growth stage of the plant [5] soil [6], the type of plant tissues, environmental and climatic conditions in which the plant is grown [7-8], microorganism's ability to colonize plants etc. According to previous studies of endophytic communities, different plant hosts bear similar community of endophytes [9] and *Bacillus* and *Pseudomonas* genera are identified as most frequently occurring in agricultural crops [10-11]. The method which is applied to study endophytes is another important factor in determining their diversity. The traditional method to study endophytes depend upon the isolation of endophytes from plant tissue [12]. Hence, the media, culture condition, the procedure which has been followed for surface sterilization [13-14] determines the spectrum of bacteria recovered. Now with the help of metagenomic analysis approaches researchers can study all microorganisms regardless of whether they can be cultured or not. In metagenomic analysis, the genetic material from a sample can be directly analysed without obtaining pure cultures [15-16]. Another important techniques by which researchers can study the endophytic bacteria in their natural habitats are GFP tagging, fluorescence in situ hybridization [FISH] [17].

Almost all plant tissues like leaves, roots, seeds, stems, fruits harbor endophytes [18]. They can enter the plants through two ways, vertical transmission and horizontal transmission. In vertical transmission, endophytes might be transmitted by seeds and during horizontal transmission, endophytes might be recruited by the soil. During the process of co-evolution with plants, endophytes have acquired traits that allow them to penetrate, colonize and translocate in the plant's interior. Flagella, fimbriae, cell surface polysaccharides, chemotaxis and synthesis of cell-wall degrading enzymes are expected to be associated with bacterial endophytes colonization [19]. Cell-wall degrading enzymes are important factor for successful colonization of endophytes. Stomata, lateral roots, outer cell layers, root cortex, phloem and xylem [20], wounds [e.g., leaf scars, root ruptures], hydathodes in the shoots are considered as the main entry points for horizontal transmission of endophytes. They can colonize plant locally or systemically and the association can be obligate or facultative. Facultative endophytes are capable to survive outside the plant during a period of their life cycle but obligate endophytes depend on the host plant for the survival and activities. Hence, obligate endophytes are those that are not culturable whereas facultative endophytes are culturable and able to survive in artificial medium [21-22]. Obligate endophytes can be transmitted from one generation to the next via seeds or vegetative plant tissues [23] while on the contrary facultative endophytes are present in environment and can colonize plant when conditions are suitable.

Over a long period of coexistence and coevolution of endophytes and their host plant, endophytes have developed many significant and novel characteristics. They have several beneficial effects on their host plant by improving their physiology. They assist plants in getting nutrients, and improve plant growth by modulating growth related hormones, secreating various cytokines and phytohormones [24]. Phosphorus is an essential element for plants. Although present in ample quantities but due to its insolubility most of the soil phosphorus cannot support the plant growth. Certain microorganisms have the ability to convert the organic form of phosphorus into available form thus increasing the availability of phosphorus for the plants. Ngamau and coworkers [2012] isolated 27 phosphate solubilizing microorganisms from banana plants in Kenya [25]. Phytohormone production is another mechanism by which endophytes promote plant growth. Production of indole-3-acetic acid [IAA], the most important member of the auxin class, is also an important characteristic of plant growth promoting bacteria [26]. Sarbadhikary and co workers [2018] isolated an endophytic fungal strain of *Aspergillus* from the *Schima wallichii* [needle wood] was found to possess good phosphate solubilizing and IAA producing ability [27].





**Ruchika Yadav et al.**

The endophytes isolated from medicinal plants are known for their antimicrobial activity [28]. Induced systemic resistance [ISR] is a mechanism which protect plants from phytopathogens. ISR induced by endophytes can protect host against fungal, bacterial and viral pathogens [29]. Endophytes have a diverse range of metabolic pathways that makes them powerful tools for bioremediation. Bioremediation is a technique in which microorganisms are introduced to remove pollutants and wastes from the environment. It relies on the microbial growth and metabolism. Mastretta and coworkers [2009] isolated endophytes from the seeds of *Nicotiana tabacum* and studied their role in bioremediation [30]. Apart from this, endophytes are also able to biosynthesize many important phytochemicals [31]. Secondary metabolites or phytochemicals are low molecular, biologically active compounds which are not directly involved in the growth of plant but have very important functions. For example as immunosuppressants, antioxidants, anticancer, antidiabetic, antibacterial, insecticidal and antiviral agents [32-33]. Vitamins like B12 [34] and B1 [35] are also supplied to plants by endophytes. While an array of biologically active compounds have been isolated from endophytes, they still possess a large untapped source of unique natural products. Endophytes are ubiquitous. They are present in almost every plant studied till date. Insights into the microbial ecology in the plants' endosphere have been greatly developed with the help of recent advances in molecular biological techniques. Various endophytes and their genes have been identified. About 3,00,000 species of plants in the world where every species is a host for one or more endophytes, only a few have been studied. Hence, information on endophyte community, their behaviour and interaction with host plant remain an important area of future research.

## REFERENCES

1. Hodkinson, T., & Murphy, B. [2019]. Endophytes for a Growing World. In T. Hodkinson, F. Doohan, M. Saunders, & B. Murphy [Eds.], *Endophytes for a Growing World* [pp. 3-22]. Cambridge: Cambridge University Press. doi:10.1017/9781108607667.002
2. Gouda, S., Das, G., Sen, S.K., Shin, H.S. and Patra, J.K., 2016. Endophytes: a treasure house of bioactive compounds of medicinal importance. *Frontiers in microbiology*, 7, p.1538.
3. Petrini, O., 1991. Fungal endophytes of tree leaves. In *Microbial ecology of leaves* [pp. 179-197]. Springer, New York, NY.
4. Ding, T., and Melcher, U., 2016. Influences of plant species, season and location on leaf endophytic bacterial communities of non-cultivated plants. *PLOS ONE*, 11: e0150895.
5. Shi, Y., Yang, H., Zhang, T., Sun, J. and Lou, K., 2014. Illumina-based analysis of endophytic bacterial diversity and space-time dynamics in sugar beet on the north slope of Tianshan mountain. *Applied microbiology and biotechnology*, 98[14], pp.6375-6385.
6. Germida, J.J., Siciliano, S.D., Renato de Freitas, J. and Seib, A.M., 1998. Diversity of root-associated bacteria associated with field-grown canola [*Brassica napus* L.] and wheat [*Triticum aestivum* L.]. *FEMS Microbiology Ecology*, 26[1], pp.43-50.
7. Penuelas, J., Rico, L., Ogaya, R., Jump, A.S. and Terradas, J., 2012. Summer season and long-term drought increase the richness of bacteria and fungi in the foliar phyllosphere of *Quercus ilex* in a mixed Mediterranean forest. *Plant Biology*, 14[4], pp.565-575.
8. Siciliano, S.D., Fortin, N., Mihoc, A., Wisse, G., Labelle, S., Beaumier, D., Ouellette, D., Roy, R., Whyte, L.G., Banks, M.K. and Schwab, P., 2001. Selection of specific endophytic bacterial genotypes by plants in response to soil contamination. *Applied and environmental microbiology*, 67[6], pp.2469-2475.
9. Mundt, J.O. and Hinkle, N.F., 1976. Bacteria within ovules and seeds. *Applied and Environmental microbiology*, 32[5], pp.694-698.
10. Seghers, D., Wittebolle, L., Top, E.M., Verstraete, W. and Siciliano, S.D., 2004. Impact of agricultural practices on the Zea mays L. endophytic community. *Applied and Environmental Microbiology*, 70[3], pp.1475-1482.
11. de Souza Sebastianes, F.L., Romao-Dumaresq, A.S., Lacava, P.T., Harakava, R., Azevedo, J.L., de Melo, I.S. and Pizzirani-Kleiner, A.A., 2013. Species diversity of culturable endophytic fungi from Brazilian mangrove forests. *Current genetics*, 59[3], pp.153-166.



**Ruchika Yadav et al.**

12. Ding, X., Liu, K., Deng, B., Chen, W., Li, W. and Liu, F., 2013. Isolation and characterization of endophytic fungi from *Campotheca acuminata*. *World Journal of Microbiology and Biotechnology*, 29[10], pp.1831-1838.
13. Gaiero, J.R., McCall, C.A., Thompson, K.A., Day, N.J., Best, A.S. and Dunfield, K.E., 2013. Inside the root microbiome: bacterial root endophytes and plant growth promotion. *American journal of botany*, 100[9], pp.1738-1750.
14. Golinska, P., Wypij, M., Agarkar, G., Rathod, D., Dahm, H. and Rai, M., 2015. Endophytic actinobacteria of medicinal plants: diversity and bioactivity. *Antonie Van Leeuwenhoek*, 108[2], pp.267-289.
15. Chun, J., Lee, J.H., Jung, Y., Kim, M., Kim, S., Kim, B.K. and Lim, Y.W., 2007. EzTaxon: a web-based tool for the identification of prokaryotes based on 16S ribosomal RNA gene sequences. *International journal of systematic and evolutionary microbiology*, 57[10], pp.2259-2261.
16. Manter, D.K., Delgado, J.A., Holm, D.G. and Stong, R.A., 2010. Pyrosequencing reveals a highly diverse and cultivar-specific bacterial endophyte community in potato roots. *Microbial ecology*, 60[1], pp.157-166.
17. Piccolo, S.L., Ferraro, V., Alfonzo, A., Settanni, L., Ercolini, D., Burruano, S. and Moschetti, G., 2010. Presence of endophytic bacteria in *Vitis vinifera* leaves as detected by fluorescence in situ hybridization. *Annals of microbiology*, 60[1], pp.161-167.
18. Benhizia, Y., Benhizia, H., Benguedouar, A., Muresu, R., Giacomini, A. and Squartini, A., 2004. Gamma proteobacteria can nodulate legumes of the genus *Hedysarum*. *Systematic and Applied Microbiology*, 27 [4], pp.462-468.
19. Piromyou, P., Songwattana, P., Greetatorn, T., Okubo, T., Kakizaki, K.C., Prakamhang, J., Tittabutr, P., Boonkerd, N., Teaumroong, N. and Minamisawa, K., 2015. The type III secretion system [T3SS] is a determinant for rice-endophyte colonization by non-photosynthetic *Bradyrhizobium*. *Microbes and environments*, p.ME15080.
20. Reinhold-Hurek, B., Maes, T., Gemmer, S., Van Montagu, M., and Hurek, T. [2006]. An endoglucanase is involved in infection of rice roots by the not-cellulose metabolizing endophyte *Azoarcus* sp. strain BH72. *Mol. Plant Microbe Interact.* 19: 181–188.
21. Waheeda K, Shyam KV [2017] Formulation of Novel Surface Sterilization Method and Culture Media for the Isolation of Endophytic Actinomycetes from Medicinal Plants and its Antibacterial Activity. *J Plant Pathol Microbiol* 8: 339-345.
22. Christina A, Christopher V, Bhore SJ [2013] Endophytic bacteria as a source of novel antibiotics: An overview. *Pharmacogn Rev* 7: 11-16.
23. Su, Y.Y., Guo, L.D. and Hyde, K.D., 2010. Response of endophytic fungi of *Stipa grandis* to experimental plant function group removal in Inner Mongolia steppe, China. *Fungal Diversity*, 43[1]: 93-101.
24. Ma, Y., Rajkumar, M., Zhang, C. and Freitas, H., 2016. Beneficial role of bacterial endophytes in heavy metal phytoremediation. *Journal of environmental management*, 174, pp.14-25.
25. Ngamau C.N., Matiru V.N., Tani A. and Muthuri C.W., 2012. Isolation and identification of endophytic bacteria of bananas [*Musa sp.*] in Kenya and their potential as biofertilizers for sustainable banana production. *African Journal of Microbiology Research*, 6[34]: 6414-6422.
26. Fu, S.F., Wei, J.Y., Chen, H.W., Liu, Y.Y., Lu, H.Y. and Chou, J.Y., 2015. Indole-3-acetic acid: A widespread physiological code in interactions of fungi with other organisms. *Plant signaling & behavior*, 10[8], p.e1048052.
27. Sarbadhikary, S.B. and Mandal, N.C., 2018. Elevation of plant growth parameters in two solanaceous crops with the application of endophytic fungus. *Indian Journal of Agricultural Research*, 52[4], pp.424-428.
28. Yadav, V., Singh, A., Mathur, N. and Yadav, R., 2020. Isolation and characterization of *Alternaria* GFAV15, an endophytic fungus from green fruit of *Tinospora cordifolia* [Willd.] Miers from semi-arid region. *South African Journal of Botany*, 134, pp.343-348.
29. Alvin, A., Miller, K.I. and Neilan, B.A., 2014. Exploring the potential of endophytes from medicinal plants as sources of antimycobacterial compounds. *Microbiological research*, 169[7-8], pp.483-495.
30. Mastretta, C., Taghavi, S., Van Der Lelie, D., Mengoni, A., Galardi, F., Gonnelli, C., Barac, T., Boulet, J., Weyens, N. and Vangronsveld, J., 2009. Endophytic bacteria from seeds of *Nicotiana tabacum* can reduce cadmium phytotoxicity. *International Journal of Phytoremediation*, 11[3], pp.251-267.
31. Zhang HW, Song YC, Tan RX. 2006. Biology and chemistry of endophytes. *Nat Prod Rep*, 23:753–771.





## Ruchika Yadav et al.

32. Brader, G., Compant, S., Mitter, B., Trognitz, F. and Sessitsch, A., 2014. Metabolic potential of endophytic bacteria. *Current opinion in biotechnology*, 27, pp.30-37.
33. Aly, A.H., Debbab, A. and Proksch, P., 2011. Fungal endophytes: unique plant inhabitants with great promises. *Applied microbiology and biotechnology*, 90[6], pp.1829-1845.
34. Ivanova, E.G., Fedorov, D.N., Doronina, N.V. and Trotsenko, Y.A., 2006. Production of vitamin B 12 in aerobic methylotrophic bacteria. *Microbiology*, 75[4], pp.494-496.
35. Mercado-Blanco, J. and Bakker, P.A., 2007. Interactions between plants and beneficial *Pseudomonas* spp.: exploiting bacterial traits for crop protection. *Antonie van Leeuwenhoek*, 92[4], pp.367-389.
36. Asis Jr, C.A. and Adachi, K., 2004. Isolation of endophytic diazotroph *Pantoea agglomerans* and nondiazotroph *Enterobacter asburiae* from sweetpotato stem in Japan. *Letters in Applied Microbiology*, 38[1], pp.19-23.
37. Iniguez, A.L., Dong, Y. and Triplett, E.W., 2004. Nitrogen fixation in wheat provided by *Klebsiella pneumoniae* 342. *Molecular Plant-Microbe Interactions*, 17[10], pp.1078-1085.
38. Krause, A., Ramakumar, A., Bartels, D., Battistoni, F., Bekel, T., Boch, J., Böhm, M., Friedrich, F., Hurek, T., Krause, L. and Linke, B., 2006. Complete genome of the mutualistic, N<sub>2</sub>-fixing grass endophyte *Azoarcus* sp. strain BH72. *Nature biotechnology*, 24[11], pp.1384-1390.
39. Fouts, D.E., Tyler, H.L., DeBoy, R.T., Daugherty, S., Ren, Q., Badger, J.H., Durkin, A.S., Huot, H., Shrivastava, S., Kothari, S. and Dodson, R.J., 2008. Complete genome sequence of the N<sub>2</sub>-fixing broad host range endophyte *Klebsiella pneumoniae* 342 and virulence predictions verified in mice. *PLoS genetics*, 4[7], p.e1000141.
40. Prasad, M.P. and Dagar, S., 2014. Identification and characterization of Endophytic bacteria from fruits like Avacado and Black grapes. *Int J Curr Microbiol App Sci*, 3[8], pp.937-947.
41. Selim, K.A., Ahmed, A., Abdel-Rahman, T.M. and El-Diwany, A.I., 2014. Biological evaluation of endophytic fungus, *Chaetomium globosum* JN711454, as potential candidate for improving drug discovery. *Cell biochemistry and biophysics*, 68[1], pp.67-82.
42. Akinsanya, M.A., Goh, J.K., Lim, S.P. and Ting, A.S.Y., 2015. Diversity, antimicrobial and antioxidant activities of culturable bacterial endophyte communities in Aloe vera. *FEMS microbiology letters*, 362[23], p.fnv184.
43. Singh, R. and Dubey, A.K., 2015. Endophytic actinomycetes as emerging source for therapeutic compounds. *Indo Global J Pharm Sci*, 5[2], pp.106-116.
44. Marcos, F.C.C., Iório, R.D.P.F., Silveira, A.P.D.D., Ribeiro, R.V., Machado, E.C. and Lagôa, A.M.M.D.A., 2015. Endophytic bacteria affect sugarcane physiology without changing plant growth. *Bragantia*, 75, pp.1-9.
45. Ma, X., Nontachaiyapoom, S. and Jayawardena, R.S., 2018. Endophytic *Colletotrichum* species from *Dendrobium* spp. in China and Northern Thailand. *MycKeys*, [43], p.23.

Table 1: List of Some Endophytes Reported

Endophyte	Plant	Reference
<i>Bacillus</i> sp.	Canola	6
<i>Enterobacter asburiae</i>	Sweet potato	36
<i>Mycobacterium</i> sp.	Wheat	37
<i>Azoarcus</i> sp.	Kallar grass	38
<i>Klebsiella pneumoniae</i>	Maize	39
<i>Bacillus</i> sp.	Avacado and black grapes	40
<i>Chaetomium globosum</i>	Maidenhair fern	41
<i>Pseudomonas hibiscicola</i>	Aloe Vera	42
<i>Streptomyces</i> sp. Tc 052	Siamese ginger	43
<i>P. fluorescens</i>	sugercane	44
<i>Colletotrichum</i> sp	<i>Dendrobium</i> spp.	45
<i>Alternaria</i> GFAV15	Giloy	28





## Discourse on the Financial Inclusion of Uttarakhand: An Empirical Analysis on Changing Dynamics of Demography

Thakur Dev Pandey<sup>1</sup> and Shilpi Gupta<sup>2\*</sup>

<sup>1</sup>Assistant Professor, Department of Economics, Manipal University Jaipur, Rajasthan-303007, India.

<sup>2</sup>Associate Professor, Department of Economics, Manipal University Jaipur, Rajasthan-303007, India.

Received: 25 Nov 2021

Revised: 29 Dec 2021

Accepted: 12 Jan 2022

### \*Address for Correspondence

#### Shilpi Gupta

Associate Professor,

Department of Economics,

Manipal University Jaipur,

Rajasthan-303007, India.

Email: guptashilpi09@gmail.com



This is an Open Access Journal / article distributed under the terms of the **Creative Commons Attribution License** (CC BY-NC-ND 3.0) which permits unrestricted use, distribution, and reproduction in any medium, provided the original work is properly cited. All rights reserved.

### ABSTRACT

To analyse the performance of financial inclusion in pace of social inclusion, economic growth and economic development, research selected Uttarakhand state for study. The paper examined the impact of mainstream banking on the financial Inclusion of Uttarakhand State and analyse the extent of financial inclusion by constructing own Dynamic Financial Inclusion Penetration DFIP Index for the dynamic population. This Index explored the performance of various dimensions by calculating penetration, based on selected indicators like demography, geographic area and banking services using time series data from 2013-21. Based on the findings from DFIP Index, the research concluded that financial inclusion in the Uttarakhand State is being limited to the geographic and Demographic penetration of banks, ATMs and PoS, which ignites a further discussion that it is not the bank account for which the financial inclusion is emphasised, but it is the credit service from the mainstream banking which promotes economic growth, women empowerment, and poverty reduction. The research suggested that supply and demand side of financial inclusion is sufficient in Uttarakhand but the requirement of creditability and the business potential for common individuals must be enhanced through innovation and development programme also efficient implementation, monitoring and evaluation of such programmes is required to achieve the targets of financial inclusion.

**Keywords:** Financial Inclusion, Banking, Financial Inclusion Index, DFIP Index (Dynamic financial inclusion penetration index), social inclusion, economic growth and economic development







**Thakur Dev Pandey and Shilpi Gupta**

**INTRODUCTION**

Financial inclusion is generally defined as a means of providing basic banking products and services to mass population. Earliest significance for financial inclusion was reported by a British economist Walter Bagehot in his work ‘*Lombard Street: A Description of the Money Market*’ (1873) [1]. Bagehot pointed out that Financial Inclusion is critical for economic growth, as access to financial products and services such as credit and savings deposits facilities encourages economic activity. Since, banks acts as financial intermediary and channelize funds from depositors to investors. The creditors invest this fund and engage in economic activities. In this way the output of the economy increases, and it produces an economic stimulus for the whole economy.

The contemporary domains of financial inclusion are significant and relevant for developing countries, Bagli (2012) [2] found that access to financial services must include identifying different demand and supply constraints and frictions that lead to financial exclusion. Raghuram Rajan Committee (2007) [3] considered financial inclusion as an access to a basic banking services and products at an affordable cost. It includes standard banking services along with certain specific financial services such as insurance and equity products. Asher, Mukul G (2007)[4] found that financial inclusion in India can be achieved by the reformation of governance and regulation of urban cooperative banks. N. Srinivasan (2007)[5] noted that branch density is important factor to reduces financial exclusion in India. Shankar, et.al., (2013)[6], Ghosh, et. al.,(2013) [7],Barman, et. al.,(2009) [8], and Ghosh,(2007) [9] emphasized the microfinance institutions to play a crucial role to promote financial inclusion. Sarma (2008)[10] developed a financial inclusion index based on three important dimensions viz., outreach of the bank branches, availability and Usage as the volume of deposits and credit as a percentage of GDP to rank states on the intensity of financial inclusion. Gupte, et. al., (2012) [11]too constructed a composite index of financial inclusion for India for 2008 and 2009 as a geometric mean of outreach of Bank Branches, Usage of Bank services as Credit and Deposit, Ease of Transaction and Cost of Transaction and identified factors for financial exclusion in the country.

**RESEARCH METHODOLOGY**

The research studies the impact of banking in financial inclusion of Uttarakhand State, extent of banking is measured in the number of bank offices opened in the state, the number of bank employees, the number of accounts opened in the SCBs and the prevailing Credit-Deposit Ratio. Sources of the data are Reports from Lead Bank, State Annual Credit Plan of SLBC Uttarakhand [12], Agenda Book of SLBC, Handbook of statistics on Indian Economy and various reports and publications of the RBI[13]. The Dynamic Financial Inclusion Penetration Index (DFIP) is computed for Uttarakhand State as a geometric mean of three critical dimensions – outreach (penetration and accessibility), usage and adequacy of banking service during 2014 to 2020, following the similar methodology used by UNDP in computing HDI in 2010 [14].

Each dimension  $d_i$  contains  $n$  number of subdimension and is a simple average of all the  $d_{ij}$  such that,

$$d_i = X_1, X_2, X_3, \dots, X_n$$

For each dimension  $d_i$  we compute  $D_{ij}$  as:

$$d_{ij} = \frac{d_A - d_{Min}}{d_{Max} - d_{Min}} \dots\dots\dots(i)$$

Where

$d_{ij}$  = Dimension

$d_A$  = Actual Value of  $d_{ij}$

$d_{Min}$  = Minimum Value of  $d_{ij}$

$d_{Max}$  = Maximum Value of  $d_{ij}$

This ensures that  $d_{ij}$  lies between 0 and 1 and the higher the value of  $D_{ij}$ , higher the achievement in dimension.

$$D_i = \frac{\sum d_{ij}}{n} \dots\dots\dots(ii)$$

$i$  = various dimensions of financial inclusion





**Thakur Dev Pandey and Shilpi Gupta**

**Outreach Dimension**

**D<sub>1a</sub> (Geographic Penetration)**

Geographic penetration of Bank per 10 sq. km, Geographic penetration of ATM per 10 sq. kms. With the criteria of minimum 1 bank office per 20 sq. kms and maximum 1 bank office per 10 sq. kms and minimum 1 ATMs and Point of Scale (PoS) Machines per 17 sq. Kms and maximum 1 ATMs and PoS per 1.5 sq. Kms.

$$d1a1 = \frac{NBPO}{A} \times 10 \dots\dots\dots(iii)$$

d1a1 = Geographic Penetration of Banks per 10 km sq  
 NBPO = Number of Banks and Post Offices  
 A = Area of Uttarakhand (53483 Km square)

$$d1a2 = \frac{NAP}{A} \times 10 \dots\dots\dots(iv)$$

d1a2 = Geographic Penetration of ATMs km sq  
 NAP = Number of ATMs and PoS.  
 A = Area of Uttarakhand (53483 Km square)

$$D1a = \frac{d1a1+d1a2}{2} \dots\dots\dots(v)$$

**D<sub>1b</sub>(Demographic Penetration):** Demographic penetration of Banks per 1000-person, and demographic penetration of ATM per 1000 person with the criteria of minimum 1 bank office per 6667 population and maximum 1 bank office per 2500 population and minimum 1 ATM and PoS Machine per 6667 population and maximum 1 ATM and PoS Machine per 500 population.

$$d1b1 = \frac{NBPO}{P} \times 1000 \dots\dots\dots(vi)$$

d1b1 = Demographic Penetration of Banks per 1000 population  
 NBPO = Number of Banks and Post Offices  
 P = Dynamic Population of Uttarakhand

$$d1b2 = \frac{NAP}{P} \times 1000 \dots\dots\dots(vii)$$

d1b2 = Demographic Penetration of ATMs per 1000 population  
 NAP = Number of ATMs and PoS.  
 P = Dynamic Population of Uttarakhand

$$D1b = \frac{d1b1+d1b2}{2} \dots\dots\dots(viii)$$

**D<sub>2</sub> (Bank Usage)**

Number of Bank account as a percent of population with average of two accounts per person. Credit-Deposit Ratio. The criteria being minimum 40 per cent of the population have bank and post office saving accounts and maximum 80 per cent of population have bank and post office saving account and minimum 40 per cent Credit-Deposit (C.D.) Ratio and maximum 80 per cent C.D. Ratio.

$$d2.1 = \frac{SABP}{2P} \dots\dots\dots(ix)$$

d2.1 = Adjusted Saving Accounts in Banks and Post Offices  
 SABP = Total Saving Accounts in Banks and Post Offices





**Thakur Dev Pandey and Shilpi Gupta**

P = Dynamic Population of Uttarakhand

$$d2.2 = \frac{CD\ Percent}{100} \dots\dots\dots(x)$$

d2.1 = Credit Deposit Ratio as decimal number  
 CD Percent = Credit Deposit Ratio as per cent

$$D2 = \frac{d2.1+d1.2}{2} \dots\dots\dots(xi)$$

**D<sub>3</sub> (Bank Service)**

Number of Bank Employee per 500 of population with the criteria of minimum 1 bank employee per 1250 population and maximum 1 bank employee per 500 population.

$$d3 = \frac{NBE}{P} \dots\dots\dots(xii)$$

d3 = Bank Employees and Banking Correspondents  
 NBE = Total number of bank employees and Banking Correspondents  
 P = Dynamic Population of Uttarakhand

**Dynamic Financial Inclusion Penetration (DFIP) Index**

DFIP Index for a year is calculated as a geometric mean of three dimensions i.e., outreach dimension containing geographic and demographic penetration of banks, ATMs and PoS Machines, Bank Usage dimension and Bank Service dimension corresponding to that year.

$$DFIPIndex_{year} = (D_{1a}. D_{1b}. D_2. D_3)^{1/4} \dots\dots\dots(xiii)$$

**DATA ANALYSIS**

**Banking Infrastructure in Uttarakhand**

The number of bank offices in a region depicts the level of penetration of financial services. During 2013 there were a total of 1586 Scheduled Commercial Banks (SCBs) and 2718 Post Offices in the state which shows 0.80 banks in 10 Sq km whereas, availability of 0.35 share of bank office for 1000 people.

During 2017 the number of bank offices increased to 2029 and the number of Post Offices remained same to 2718 with the availability of 0.89 bank and post offices per 10 sq kms and 0.27 share of bank for 1000 people. During 2019 the number of bank offices was reported to be 2351 and 2718 Post Offices as a thus availability of 0.95 share of bank and post offices per 10 sq km and availability of 0.24 share of bank and post offices for 1000 people. The increasing number of bank offices in the state shows higher thrust of the government and the RBI in reducing the supply side issue in financial inclusion and this reduced the rising burden of growing population on the bank offices. As per various Report of RBI, during 2013 a total of 2652 ATMs and 796 Point of Scale Machines (PoS) were deployed in the State with average 0.64 ATMs and PoS Machines per 10 Sq Km and a share of 0.28 ATMs and PoS per 1000 people. The number of ATMs increased slightly during the period 2015 but there was more than 100 per cent growth in the PoS Machines in the State with the availability of an average of 0.78 ATMs per 10 Kms.

During the period 2017 the number of ATMs decreased to 2649 but the PoS Machines increased to 6396 this boosted the average availability of ATM and PoS per 10 sq km to 1.69, the decrease in ATMs could be attributed to the depreciation of the old ATMs and structural and technological gap to replace the failing ATMs. In 2020, the total number of operational ATMs and PoS stand at 21090 this made the availability of 3.94 ATMs and PoS per 10 sq Kms and 0.89 ATMs and PoS per 1000 people. Employees of the bank also play an important role in providing efficient



**Thakur Dev Pandey and Shilpi Gupta**

financial services to the population and a healthy ratio between employees and customers significantly aids in financial inclusion. During the period 2013 a total of 12,873 employees and 336 Banking Correspondents (BC) were reported in the SCBs of Uttarakhand, which was 0.54 share of an employee for 100 people. The number of employees increase in 2015 to 14,911 and were 0.15 per 100 people which means one employee for 667 people. During the year 2016 & 2017 the share was same as was in 2015.

During 2014-2020 the growth rate on the total number of savings accounts reported at 102.3 percent. The data in Table 4 shows that the growth rate of savings accounts in commercial banks was highest during 2014 and 2015 this boost is attributed to the Pradhan Mantri Jan Dhan Yojana (2014) [15]. After 2016 the growth rate of savings account in bank and post offices started saturating and a uniform growth rate in accounts was registered. Table 4 also shows the C.D. Ratio for Uttarakhand State for the period of 2014 to 2015. It is to be noted that the C.D. Ratio of the state was highest at 63.29 during 2014 and after 2014, the ratio declined till 2017 to lowest of 55.31.

## RESULTS AND FINDINGS

### The Outreach Dimension

D1 is the Dimension index of Outreach and takes into account the Geographic and Demographic penetration of Bank Branch offices and ATMs. The study have categorised D1 into two variables D1a and D1b. D1a dimension is used for the variable Geographic Branch office penetration, Geographic ATM penetration, per 10 square kilometre of the State, Dimension D1b is used for the Demographic Branch office penetration, Demographic ATM penetration, per 1000 of population. This Dimension examines the penetration and accessibility. This dimension is directly proportional to the FII, i.e. higher the FII, the higher the DFIP Index. The values of this dimension during 2014-2020 are given below in Table respectively in Table 5

### The Usage Dimension

D<sub>2</sub> is the Dimension index for Usage and includes the Number of Bank accounts as a percent of population and Credit-Deposit Ratio. Results for 2014 to 2020 are given in the Table 6 respectively:

### The Bank Service Dimension

D<sub>3</sub> is the Dimension index for the Service of the SCBs in Uttarakhand State and includes the number of employees in the SCBs in Uttarakhand.

Results for the period 2014-20 are given in the Table 7.

### Dynamic Financial Inclusion Penetration Index

Using the values of all four dimensions values we compute the Dynamic Financial Inclusion Penetration (DFIP) Index for Uttarakhand State for the period 2014 to 2020. Table 8 gives the Dimension wise summary and the DFIP Index of Uttarakhand for 2014-20. The Dynamic index rises from 0.35 in 2014 to 0.40 in 2015 further it decreased to 0.32 in 2017, this deterioration comes largely through D<sub>3</sub> i.e., Service dimension as the employee customer ratio was poor in the State, and further the Capital-Deposit ratio was comparatively small which affected the D<sub>2</sub> Dimension. Demographic penetration of Banks and ATMs are falling due to growing population of State, this shows a rising gap in the demand and supply of banking services offered by traditional banking infrastructure thus, however, this gap can be fulfilled by technological means like mobile and internet banking services.

## CONCLUSION AND SUGGESTIONS

The Reserve Bank of India adopted the broad approach to financial inclusion aiming at connecting people with the banking system and not just giving credit, but also provide them access to payments system and expose financial inclusion as a viable business model and opportunity. India has sufficient schemes, rules, and directives focussing on





### Thakur Dev Pandey and Shilpi Gupta

expansion of banking coverage and ensuring service to the unbanked population. The RBI formulated regulation with framework covering employment intensive; strengthening of the rural cooperatives; and restructuring of regional rural banks, which cater predominantly to the rural areas. Banks and financial institutions in Uttarakhand have done well in the direction of widening and deepening of mainstream banking roots and extending other banking services since the formation of the State. The study found that due to the dynamic change in the population the traditional means of financial inclusion can be only limited with the opening of banks branches, ATMs and PoS Machines in the regions where population concentration is high but, it is also evident from the study that savings accounts are primarily opened for making small deposits and getting subsidies rather than taking credits from banks for any business purpose which is reflected in low C.D. Ratio in the Uttarakhand State, therefore much of the emphasis has to done in the direction to promote business activities through a sound credit disbursal mechanism, then only the we can say that financial inclusion can act as an instrument to make solutions for which it is intended to be.

## REFERENCES

1. Bagehot, Walter. "Lombard Street: A description of the money market". Scribner, Armstrong & Company (1873).
2. Bagli, Supravat, and Papita Dutta. "A study of Financial Inclusion in India." *Radix international journal of economics & business management* 1, no. 8 (2012): 1-18.
3. Prasad, Eswar S., and Raghuram G. Rajan. "next Generation." *Finance & Development* (2008).
4. Asher, Mukul G. "Reforming governance and regulation of urban cooperative banks in India." *Journal of financial regulation and compliance* 15, no. 1 (2007): 20-29.
5. Srinivasan, N. "Policy issues and role of banking system in financial inclusion." *Economic and Political Weekly* (2007): 3091-3095.
6. Shankar, Savita. "Financial Inclusion in India: Do Microfinance Institutions Address Access Barriers." *ACRN Journal of Entrepreneurship Perspectives* 2, no. 1 (2013): 60-74.
7. Ghosh, Jayati. "Microfinance and the challenge of financial inclusion for development." *Cambridge journal of economics* 37, no. 6 (2013): 1203-1219.
8. Barman, Deepak, Himendu P. Mathur, and Vinita Kalra. "Role of microfinance interventions in financial inclusion: A comparative study of microfinance models." *Vision* 13, no. 3 (2009): 51-59.
9. Ghosh, Dr. "Financial inclusion through micro finance in India and emerging role of POSB: An analysis." (2007).
10. Sarma, M. (2008). Index of Financial Inclusion. Working paper 215, Indian Council for Research on International Economic Relations.
11. Gupte, Rajani, BhamaVenkataramani, and Deepa Gupta. "Computation of financial inclusion index for India." *Procedia-Social and Behavioral Sciences* 37 (2012): 133-149.
12. State Level Bankers' Committee of Uttarakhand. Agenda Book. Various issues.
13. Reserve Bank of India. Handbook of Statistics on the Indian Economy. Various issues.
14. Klugman, Jeni, Francisco Rodríguez, and Hyung-Jin Choi. "The HDI 2010: new controversies, oldcritiques." *The Journal of Economic Inequality* 9.2 (2011): 249-288.
15. Kaur, Harpreet, and Kawal Nain Singh. "Pradhan Mantri Jan Dhan Yojana (PMJDY): a leap towards financial inclusion in India." *International Journal of Emerging Research in Management & Technology* 4.1 (2015): 25-29.

**Table 1: Number of Bank Offices in Uttarakhand (2014-20)**

Year	Number of Bank Offices	Post offices	Geographic Penetration (Per 10 sq. Km)	Demographic Penetration dynamic population method (Per 1000 People)
2014	1739	2718	0.83	0.33
2015	1903	2718	0.86	0.31
2016	1978	2718	0.88	0.29




**Thakur Dev Pandey and Shilpi Gupta**

2017	2029	2718	0.89	0.27
2018	2305	2718	0.94	0.26
2019	2351	2718	0.95	0.24
2020	2366	2722	0.95	0.21

Source: Annual Report RBI, 2014-2020.

**Table 2: Number of ATMs in Uttarakhand (2014-20)**

Year	Number of ATMs	POS	Geographic Penetration (Per 10 sq Km)	Demographic Penetration (Per 1000 Person)
2014	2634	1557	0.78	0.31
2015	2677	2507	0.97	0.35
2016	2675	3579	1.17	0.39
2017	2649	6396	1.69	0.51
2018	2677	8027	2.00	0.55
2019	2631	10495	2.45	0.61
2020	2681	18409	3.94	0.89

Source: Annual Report RBI, 2014-2020.

**Table 3: Number of Employees in SCBs in Uttarakhand (2014-20)**

Year	Employees Banks	Banking Correspondents	Employee per 500 People
2013	12,873	336	0.54
2014	13,903	701	0.54
2015	14,911	1439	0.55
2016	14,787	1467	0.50
2017	15,337	1614	0.48
2018	18,612	1662	0.52
2019	19,763	2296	0.51
2020	20,078	2296	0.47
2021	20,819	2630	0.45

Source: Annual Report RBI, 2014-2020.

**Table 4: Saving Accounts 2014-20**

Year	Number of savings Accounts	Number of Savings Accounts in Post Offices	Credit Deposit Ratio
2014	8976716	5236105	63.29
2015	15144263	6156582	60.06
2016	18076344	6339510	59.22
2017	17434683	6135608	55.42
2018	18835267	6265196	57.31
2019	19464594	6394784	59.76
2020	21897550	6849480	56.85

Source: Annual Report RBI, 2014-2020.





**Thakur Dev Pandey and Shilpi Gupta**

**Table 5: Outreach 2014-20**

Year	Geographic Branch Penetration	Geographic ATM Penetration	D <sub>1a</sub>	Demographic Branch Penetration	Demographic ATM Penetration	D <sub>1b</sub>
	(d <sub>1a1</sub> )	(d <sub>1a2</sub> )		(d <sub>1b1</sub> )	(d <sub>1b2</sub> )	
2014	0.67	0.03	<b>0.35</b>	0.73	0.09	<b>0.41</b>
2015	0.73	0.05	<b>0.39</b>	0.65	0.11	<b>0.38</b>
2016	0.76	0.08	<b>0.42</b>	0.56	0.13	<b>0.34</b>
2017	0.78	0.16	<b>0.47</b>	0.46	0.19	<b>0.33</b>
2018	0.88	0.20	<b>0.54</b>	0.42	0.21	<b>0.32</b>
2019	0.90	0.26	<b>0.58</b>	0.34	0.25	<b>0.29</b>
2020	0.90	0.48	<b>0.69</b>	0.26	0.40	<b>0.33</b>

Note: (i) Geographic Branch Penetration: It is defined as the number of branches of Scheduled commercial banks and post offices per 10 sq.km. Min = 0.5 Max = 1. (ii) Geographic penetration of ATM: The number of ATM's and POS Machines per 10 sq.km. Min = 0.6 Max = 7 (iii) Demographic branch penetration: The number of bank branches and Post Offices per 1000 people. The branches for commercial, cooperative banks, state financial institutions and micro finance institutions. Min = 0.15 Max 0.15 (iv) Demographic ATM penetration: The number of ATM's and POS per 1000 people. Max = 2 Min 0.15.

Source: Annual Reports of The RBI (2013-21), various reports

**Table 6: The Usage Dimension D<sub>2</sub>(2014-20)**

Year	Bank Account as a percent of Population (d <sub>2.1</sub> )	Credit-Deposit Ratio (d <sub>2.2</sub> )	D <sub>2</sub>
2014	0.32	0.58	0.45
2015	0.81	0.50	0.65
2016	0.88	0.48	0.68
2017	0.65	0.39	0.52
2018	0.60	0.43	0.52
2019	0.50	0.49	0.50
2020	0.52	0.42	0.47

Note: (i) Bank Account as a Percent of Population: It is defined as the number of bank accounts in the SCBs as a percent of population with assuming average of two accounts per person. Min=0.15 Max = 0.8 (ii) Credit-Deposit Ratio: It is ratio between the Credit and the Deposits with SCBs in Uttarakhand. Min = 0.4 max = 0.8

**Table 7: Bank Service (2014-20)**

Year	Bank Service (D <sub>3</sub> )
2014	0.24
2015	0.26
2016	0.17
2017	0.13
2018	0.20
2019	0.19
2020	0.12

Note: Bank Service: It is defined as the number of employees and BCs in the SCBs of Uttarakhand State per 100 people. Min = 0.4 Max = 1.





**Thakur Dev Pandey and Shilpi Gupta**

**Table8: Financial Inclusion Uttarakhand (2014-20)**

Year	2014	2015	2016	2017	2018	2019	2020
<b>D1a</b>	0.35	0.39	0.42	0.47	0.54	0.58	0.69
<b>D1b</b>	0.41	0.38	0.34	0.33	0.32	0.29	0.33
<b>D2</b>	0.45	0.65	0.68	0.52	0.52	0.50	0.47
<b>D3</b>	0.24	0.26	0.17	0.13	0.20	0.19	0.12
<b>DFIP Index</b>	0.35	0.40	0.36	0.32	0.36	0.35	0.34







## An Assessment of Heavy Metal Distribution in Manakudy Estuarine Water, Kanyakumari District, Tamilnadu, India

P. Kavitha<sup>1</sup> and Pani Malar Hency M<sup>2\*</sup>

<sup>1</sup>Assistant Professor, Department of Chemistry, Women's Christian College, Nagercoil, Affiliated to Manonmaniam Sundaranar University, Abishekapatti, Thirunelveli-627012, Tamil Nadu, India.

<sup>2</sup>Research Scholar, Reg. No. 19213282032008, Department of Chemistry, Women's Christian College, Nagercoil, Affiliated to Manonmaniam Sundaranar University, Abishekapatti, Thirunelveli-627012, Tamil Nadu, India.

Received: 19 Nov 2021

Revised: 14 Dec 2021

Accepted: 13 Jan 2022

### \*Address for Correspondence

#### Pani Malar Hency M

Research Scholar, Reg. No. 19213282032008,

Department of Chemistry, Women's Christian College, Nagercoil,

Affiliated to Manonmaniam Sundaranar University,

Abishekapatti, Thirunelveli-627012,

Tamil Nadu, India.

Email: panimalarhency50@gmail.com



This is an Open Access Journal / article distributed under the terms of the **Creative Commons Attribution License** (CC BY-NC-ND 3.0) which permits unrestricted use, distribution, and reproduction in any medium, provided the original work is properly cited. All rights reserved.

### ABSTRACT

Environmental pollution especially from heavy and trace metals in the freshwater is the most serious problem in India. These heavy metals are transported by runoff water and contaminate water sources lower reaches from various point sources like metal processing tanneries, lead in petrol etc., The present study investigated the distribution of trace, heavy and soft metals (Fe, Mn, Cr, Cu, Pb, Zn, Al, Ni, Cd, Na, K, Ca, Mg) and their correlation to the abundance of metals in Manakudy estuarine water, Kanyakumari district, Tamilnadu, India. All six water samples were collected from stations around the estuary from August 2019 to July 2020. The maximum value of most of the metals observed in station 5 and considered as the contaminated site. This may be due to the interference of sea water containing minerals, Oysters, snail tiles from the nearest salt pan and also it receives pollutant from the journey of the Pazhayar river.

**Keywords:** Estuary; Runoff water; Heavy metals; Soft metals; Sea water.

### INTRODUCTION

Water is considered to be one of the most abundant natural resources but also be misused. Especially surface water data reveal significant spatial variation. This has been through stresses from Industrialization, population growth and technological developments in recent years that have led to a huge increase and accretion of heavy metals in the environment (Liu *et al.*, 2009). Worldwide surface water quality is governed by complex anthropogenic activities and

38364





### Kavitha and Pani Malar Hency

natural processes (weathering erosion, hydrological features, climate change, precipitation, industrial activities, agricultural land use, sewage discharge and human exploitation of water resources (Puri *et al.*, 2015). Heavy Metals are naturally occurring elements in the environment and vary in concentrations across the earth that has a density at least five times greater than water. Unlike organic toxins it can be degraded to less harmful components by biological or chemical processes, So Heavy metals are considered to be non-degradable pollutants (Garrett *et al.*, 2000). Some heavy metals are not harmful to the environment, because they play an essential role in tissue metabolism and growth of plants and animals. Metals like Cu, Zn, Fe, Co, Mo and Ni etc., are essential and at the same time it becomes toxic when their level exceeds the limit, and V, Cd, Pb, and Hg are prominently classified as toxic because of their harmful effect even at low concentrations (Michael, 2010).

Heavy metals are important for the proper functioning of biological systems but their deficiency or excess could lead to many disorders (Imane Ilou *et al.*, 2012). Heavy metals such as mercury, cadmium, chromium and lead are not required even in small amounts by any organisms (Mohamed *et al.*, 2016). The low concentrations of these metals exhibit extreme toxicity. This makes regular monitoring of the aquatic environment is to be necessary. The objective of the study is to assess some selected trace, heavy and soft metal distribution in surface water of the Manakudy estuary.

## MATERIALS AND METHODS

### Description of study area

Kanyakumari is the southernmost district of Tamil Nadu and it forms the southern tip of India. The District is bounded by Tirunelveli District on the north and the east. It has a rainfall both during the South West (June to August) and North East (October to December) monsoons. The Manakudy estuary is one of the major estuaries in the Kanyakumari district. It is one that naturally connects the Arabian Sea and the Pazhayar river. It act as the habitat for lot of biotic communities and the mangrove forest in Manakudy provide shelter for variety of foreign birds. In the present six stations were selected around the Manakudy estuary. The description of study sites is represented in Table.1

### Sampling

The surface water samples were collected from the sampling sites during three seasons. Samples were collected in precleaned plastic cans. The cans were acidified with 1:1 dilute hydrochloric acid and rinsed with distilled water and dried before collection of water samples. The precleaned cans were labelled with station number and date. The collected water samples were analyzed to find out the concentration of heavy, trace and soft metals like iron, manganese, chromium, copper, lead, zinc, aluminium, nickel, cadmium, sodium, potassium, calcium and magnesium.

## METHODOLOGY

Samples were filtered with pore size 0.45 µm filter paper and samples were acidified with 1N HNO<sub>3</sub> at the point of collection and transported to a laboratory for analysis. The metal content of digested sample was analyzed by various analytical techniques as per the procedure described by APHA. The concentration of iron was determined using UV- visible spectrophotometer. The concentration of copper and nickel was determined using a colorimeter. The concentration of manganese, chromium, lead, zinc, aluminium, cadmium was analyzed using a flame atomic absorption spectroscopy, sodium and potassium were determined using flame photometer, the calcium and magnesium concentrations were found by EDTA method.





## RESULTS AND DISCUSSION

The mean value of selected trace, heavy and soft metal concentration in all stations studied at various seasons (pre-monsoon, monsoon, post-monsoon) in the estuarine surface water is given in Table 3. These results of heavy metal distribution on surface water can be used to identify the pollutant level in that particular sampling site. Some metals like iron, manganese, copper, and zinc are essential micronutrients; potassium and calcium are the essential components of an aquatic ecosystem (Hussein K Okoro *et al.*, 2012).

In the present study the amount of Fe varied from 0.007mg/l (S1) to 0.1217mg/l (S2); the amount of Mn varied from 0.035 mg/l (S3) to 0.1123mg/l (S2). Copper is also an essential substance to human life, an essential element for mammalian, which is also used in agriculture. But in high doses (> 2 mg/l) it can cause several health defects. The amount of copper varied from 0.0058 mg/l (S3) to 0.03 mg/l (S5). The amount of zinc varied from 20 mg/l (S3) to 50 mg/l (S1). Heavy metals like cadmium, chromium, and lead are considered toxic metals. During the present study the amount of cadmium varied from 0.022 mg/l (S2) to 0.0261mg/l (S6); the amount of chromium varied from 0.0589 mg/l (S1) to 0.1044mg/l (S6); the amount of lead varied from 0.1702mg/l (S2) to 0.3647mg/l (S5); the amount of aluminium varied from 0.35 mg/l (S6) to 0.753mg/l (S5); the amount of nickel varied from 0.097 mg/l (S5) to 0.119 mg/l (S1). The metals zinc, chromium, lead, cadmium and aluminium were observed high concentration than permissible level.

Based on the results the distribution of soft metals like calcium, magnesium, sodium and potassium were high in all stations due to the tidal action and interference of seawater in the estuarine region. Calcium is one of the abundant and essential elements in the freshwater system. If calcium is high in the human body, which will reduce another essential mineral in the body. The amount of calcium varied from 200 mg/l (S6) to 2533mg/l (S5). The maximum value of calcium indicates a high degree of saltwater containing minerals, Oysters, snail tiles. Magnesium is an essential element for chlorophyll growth and a limiting factor for the growth of phytoplankton. A considerable amount of magnesium influences the water quality. The amount of Mg varied from 29.87 mg/l (S3) to 1112.5 mg/l (S11).

Sodium is a naturally occurring element of raw water, a highly reactive metal (Nirmala Devi *et al.*, 2018). But the high concentration of sodium causes hypertension and heart disease (Sharma *et al.*, 2018). In the present work, the amount of sodium varied from 569.5 mg/l (S1) to 7382mg/l (S5). The maximum value of sodium indicates a high degree of pollution and inflow of water from the neighbouring salt pan. Potassium was mainly found in the water by dissolved fertilizers. A high concentration of it causes various health defects like coronary artery disease. The amount of potassium varied from 31.167 mg/l (S3) to 1115.7 mg/l (S5). The high value of potassium in sediment may be due to the leaching of potassium from the surrounding crop fields, which contained potassium in the form of fertilizer.

The correlation between dissolved metal concentrations were worked out and tabulated in Table.4. These trace, heavy and soft metals have significantly positive and negative correlation. During the study period concentration of Mn showed significant positive correlation with other elements except Cr and Cd. Copper has positively correlation with other elements except Cd. The concentration of Pb, Zn and Al showed significantly positive correlation with all soft metals (Ca, Mg, Na, K).

## CONCLUSION

The results showed that the high concentration value of most of the trace and heavy metals (Cu-0.03mg/l; Pb-0.3647 mg/l, Al-0.753 mg/l, Cd-0.0261mg/l) and all the soft metals (Na, K, Ca, Mg) were observed in station 5. The metals zinc, chromium, lead, cadmium and aluminum were observed high concentrations than their permissible level in water for most of the samples. This may be due to the saltwater interference from the nearest salt pan, and the





### Kavitha and Pani Malar Hency

sewage water intrusion from the Pazhayar river. The metals Zn and Ni were high in station 1. This is the starting point of the Manakudy estuary and it receives a lot of contaminants from the journey of the river.

## ACKNOWLEDGMENT

The authors are thankful to the Principal and Head of the Department of Chemistry, Women's Christian College, Nagercoil.

## Conflicts of Interest

The authors declare no conflict of interest.

## REFERENCES

1. APHA, AWWA, WEF, 2012, 'Standard methods for the examination of water and wastewater 22nd edition, Clesceri, L.S. Greenberg, A.E. and Eaton, A.D. (Eds.)', American Public Health Association, American Water Work Association, Water Environment Federation, Washington DC.
2. Garrett, RG, 2000, 'Natural sources of metals to the environment', Human Ecological Risk Assessment, vol. 6, pp. 945–963.
3. Hussein K Okoro, Olalekan S Fatoki, Folahan A Adekola, Bhekumusa J Ximba and reinette G Snyman, 2012, 'A review of sequential extraction procedures for heavy metals speciation in soil and sediments'. Scientific Research vol.1, pp. 181.
4. Imane Ilou, Salah Souabi and Digua Khalid, 2012, 'Speciation of Metallic elements in tannery waste water case study: Mohammedia tannery Morocco', International Journal of Science & Technology 2319-7064.
5. Liu, J, Zhang, B, Cao, J, Cao, Z and Domagalski, J, 2009, 'Ecological risk of heavy metals in sediments of the Luan River source water', Ecotoxicology vol. 18, no. 6, pp. 748 – 758.
6. Michael, H C, 2010, ' Heavy metal in Encyclopedia of Earth', Edited by Monosson Cleveland C. Washington DC: National Council for Science and the Environment.
7. Mohamed, A, Hassaan Ahmed EI, Nemr Fedekar F, and Madkour, 2016, 'Environmental assessment of heavy metal pollution and human health risk', American Journal of water Science & Engineering, vol. 2, no. 3, pp. 14-19.
8. Nirmala Devi, M, Rajaram, T, 2018, 'Physico-Chemical characteristics of sediment quality in Srirangam sub watershed of Tiruchirappalli district of Tamilnadu', International Journal of Engineering & Technology, vol.7, no.(3,8), pp. 155-160.
9. Puri, P.J, Yenkie, M. K. N, Rana, D. B and Meshram, S. U, 2015, 'Application of water quality index (WQI) for the assessment of surface water quality (Ambazari lake)'. European Journal of Experimental Biology, vol. 5, no.2, pp. 37-52.
10. Sharma, K.M., Mohd, Umar Farooq, (2018) Analysis of water quality of Ramganjmandi Tesil of district Kota and their statistical interpretation. International Journal of Science and Research, vol. 7, pp. 1452-1454.

**Table1. Description of sampling sites and their coordinates**

Sampling sites	Coordinates (DD)	
	Latitude	Longitude
Station 1	8.112682	77.480686
Station 2	8.102550	77.483152
Station 3	8.094151	77.486818
Station 4	8.091796	77.484306
Station 5	8.095646	77.486500
Station 6	8.088500	77.485500





**Kavitha and Pani Malar Hency**

**Table. 2 The permissible limit for trace, heavy and soft metals in drinking water**

Metals	as per BIS	as per WHO	as per USEPA
Iron	0.3 ppm	-	30 ppm
Manganese	0.1 ppm	-	30 ppm
Chromium	0.05 ppm	-	-
Copper	0.05 ppm	25 ppm	16 ppm
Lead	0.01 ppm	-	40 ppm
Zinc	5 ppm	123 ppm	110 ppm
Aluminium	0.2 ppm	-	-
Nickel	0.01 ppm	-	-
Cadmium	0.003 ppm	6 ppm	0.6 ppm
Sodium	-	200 ppm	-
Potassium	10 ppm	12 ppm	-
Calcium	200 ppm	75 ppm	-
Magnesium	100 ppm	50 ppm	-

**Table. 3 Mean concentration (mg/l) of heavy metals in the surface water at different seasons**

Metal	S1	S2	S3	S4	S5	S6	Min	Max	Mean±SD
Fe	0.0007	0.1217	0.0140	0.0657	0.0097	0.0217	0.0007	0.1217	0.0389±0.0465
Mn	0.1000	0.1123	0.0350	0.0733	0.1000	0.0500	0.035	0.1123	0.0784±0.0310
Cr	0.0589	0.0822	0.0805	0.0977	0.0797	0.1044	0.0589	0.1044	0.0839±0.0159
Cu	0.0217	0.0250	0.0058	0.0183	0.0300	0.0154	0.0058	0.03	0.0194±0.0084
Pb	0.3371	0.1702	0.1751	0.2169	0.3647	0.2436	0.1702	0.3647	0.2513±0.0823
Zn	50.000	35.000	20.000	35.000	40.000	35.000	20	50	35.8333±9.7040
Al	0.5830	0.7500	0.5000	0.7500	0.7530	0.3500	0.35	0.753	0.6143±0.1673
Ni	0.119	0.1167	0.0973	0.1067	0.097	0.1067	0.097	0.119	0.1072±0.0093
Cd	0.025	0.022	0.026	0.023	0.0261	0.025	0.022	0.0261	0.0245±0.0016
Na	4647	1899.83	1368	569.5	7382	1639	569.5	7382	2917.56±2588.7
K	42.1833	68.5	31.167	65.667	1115.67	248	31.167	1115.7	261.8641±425.8
Ca	367	267	333	333	2533	200	200	2533	672.1667±913.6
Mg	104.53	56.00	29.87	112	1112.53	67.2	29.87	1112.5	247.0217±425.1

**Table-4: Correlation matrix of heavy metal distribution in the Manakudy estuarine water**

	Fe	Mn	Cr	Cu	Pb	Zn	Al	Ni	Cd	Na	K	Ca	Mg
Fe	1												
Mn	0.387	1											
Cr	0.281	-0.484	1										
Cu	0.228	0.907	-0.244	1									
Pb	-0.638	0.412	-0.436	0.595	1								
Zn	-0.153	0.720	-0.447	0.717	0.751	1							
Al	0.499	0.721	-0.239	0.659	0.118	0.239	1						
Ni	0.405	0.558	-0.340	0.281	-0.036	0.608	0.090	1					
Cd	-0.932	-0.445	-0.230	-0.257	0.517	-0.094	-0.476	-0.622	1				
Na	-0.470	0.536	-0.551	0.686	0.888	0.569	0.288	-0.147	0.501	1			
K	-0.481	0.416	-0.287	0.677	0.883	0.488	0.261	-0.326	0.524	0.954	1		
Ca	-0.324	0.351	-0.175	0.617	0.689	0.221	0.432	-0.534	0.455	0.856	0.934	1	
Mg	-0.311	0.370	-0.135	0.651	0.709	0.264	0.429	-0.507	0.427	0.853	0.944	0.997	1





**Kavitha and Pani Malar Hency**

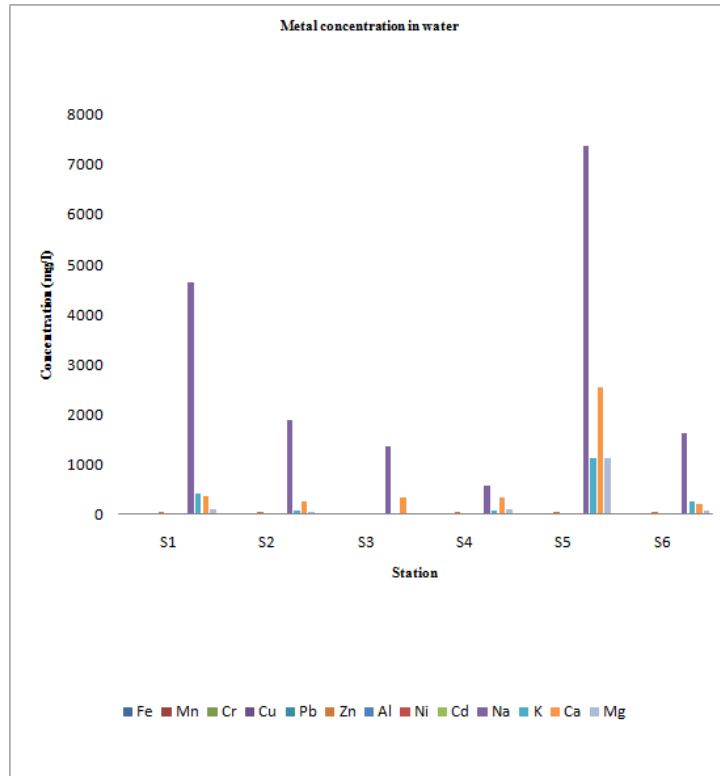


Fig.1 Graphical representation of trace, heavy and soft metal distribution in surface water





## Service Quality towards Retail Stores Across Coimbatore District

Vijayakanthan. S<sup>1</sup>, Arasuraja. G<sup>1</sup> and M. Sampath Nagi<sup>2\*</sup>

<sup>1</sup>Assistant Professor, Department of Management Studies, SRM Institute of Science and Technology, Vadapalani, Chennai -600 026. Tamil Nadu, India.

<sup>2</sup>Assistant Professor, Department of Management, Sardar Vallabhbhai Patel International School of Textile and Management (SVPISTM), Coimbatore, Tamil Nadu, India.

Received: 17 Nov 2021

Revised: 18 Dec 2021

Accepted: 21 Jan 2022

### \*Address for Correspondence

**M. Sampath Nagi,**

Assistant Professor,

Department of Management,

Sardar Vallabhbhai Patel International School of Textile and Management (SVPISTM),

Coimbatore, Tamil Nadu, India.

Email: sampathnagi@gmail.com



This is an Open Access Journal / article distributed under the terms of the **Creative Commons Attribution License** (CC BY-NC-ND 3.0) which permits unrestricted use, distribution, and reproduction in any medium, provided the original work is properly cited. All rights reserved.

### ABSTRACT

The aim of the study is to know the retail service quality of retail markets and its association with future consumption behaviour. It will help the retailers to find out the key areas for the improvement which will help in increasing the profits and developing the reputation of the company. It also adds to the knowledge of researchers and academicians, in regard to the key factors influencing the retail service quality and helpful in identifying the future course of action to increase the profitability. Thus, study will help the retailer to formulate their strategies which will fit for all the customers of different socio-economic profile characteristics to improvement of quality of services in retail stores. This study helps the retailer to identify the impact of Tangibles, Reliability, Responsiveness, Assurance, Empathy, Access and Price & Product Variety on the Expected and Perceived Service Quality.

**Keywords:** Service Quality, SEM, Tangibility.

### INTRODUCTION

Indian retail industry is the fifth largest industry in the world. India is 12th largest consumer market in the world. According to a McKinsey report, "The rise of Indian Consumer Market", Indian consumer market is estimated to grow four times by 2025. The Indian retail industry has emerged as one of the most dynamic and fast-paced industries due to the entry of several new players. It accounts for around 8 per cent of the employment and over 10 per cent of the country's Gross Domestic Product (GDP). India is the world's fifth largest global destination in the retail space. India's retail market is expected to nearly double to US\$ 1 trillion by 2020 from US \$ 600billion in 2015, driven by income growth, urbanization and attitudinal shifts. While the overall Indian retail market is expected to



**Vijayakanthan et al.,**

grow at 12 percent per annum, modern trade would increase twice as fast as 20 per cent per annum and traditional trade at 10 percent per annum.

**Service Quality**

Service quality is the assessment of how well a delivered service conforms to the customers' expectations. It is very important to assess the service quality provided to the customers in order to identify the gaps and improve the level of service to achieve the customer satisfaction.

**Service Quality = Service + Quality**

Service is a transaction in which no physical goods are transferred from the seller to the buyer. Service is not a physical entity rather it is behavioral. Services are intangible in nature. It's quite difficult for the service provider to distinguish their services from their competitors and to adopt a lucrative marketing strategy to attract the customers. For the customers also, it is very difficult to assess the service quality before experiencing the service.

$$SQ = P - E,$$

Where; SQ - Service Quality, P - Perceived Expectations, E - Perceived Performance

**Statement of the Problem**

The retail service environment is becoming increasingly competitive and is characterized by the presence of domestic as well as foreign players, frequent mergers and acquisitions, and sophisticated and demanding customers who have higher levels of expectations from service providers. Therefore, service providers need to differentiate their service offerings by meeting the needs of their customers better, improving customer satisfaction and by delivering service quality that is higher than the one that is provided by the competition. Despite a significant interest in service quality and its dimensions (e.g. reliability, responsiveness), very little research has investigated the effects of specific dimensions of service quality on satisfaction.

**Objectives of the Study**

To find out the difference on the opinion given by the respondents visiting the retail stores on Expected and Perceived Service Quality (Tangibles, Reliability, Responsiveness, Assurance, Empathy, Access and Price & Product Variety).

**Review of Literature**

The literature in this section is gathered by means of secondary sources such as books, internet and journals. The main purpose of this section is to provide context and present arguments supporting the research objectives and questions in order to draw a valid conclusion based on theoretical framework.

**Kaul (2007)** has examine the Service quality is being increasingly perceived as a tool to increase value for the consumer; and as a means of positioning in a competitive environment to ensure consumer satisfaction, retention, and patronage. Existing research indicates that consumers satisfied with the store's service quality are most likely to remain loyal. However, despite its strategic importance, Indian retailers do not have an appropriate and established instrument to measure service quality. This study examines the Retail Service Quality Scale (RSQS) developed in the US for applicability in India. RSQS has five dimensions and six sub-dimensions and has been found appropriate in a variety of settings across different countries such as South Africa and Singapore and across a variety of store types such as supermarkets, department stores, and hyper stores. The five dimensions Physical Aspects, Reliability, Personal Interaction, Problem Solving, and Policy are believed to capture distinct though correlated aspects of retail service. Each of the first three dimensions has two sub-dimensions. These six sub-dimensions, also called the first-order factors, are labeled as Appearance, Convenience, Promises, Doing it- Right, Inspiring Confidence, and Courteousness/Helpfulness. The dimensions and sub-dimensions provide strategic focus areas for retailers, enabling them to improve certain aspects of store service where performance is relatively poor. Data using a survey questionnaire from 144 adult shoppers at large format apparel stores in the city of Bangalore





**Vijayakanthan et al.,**

**Grewal and Levy** (2007) has studied the field of retailing has experienced significant changes in recent years. In this article, we review articles published in Journal of Retailing over the 2002–2007 time span, classified into ten broad topic categories: price, promotion, brand/product, service, loyalty, consumer behavior, channel, organizational, Internet, and other. Some areas have received a reasonable amount of attention; others would be worthy of additional work. We summarize a key insight from each article in the Appendix. Finally, we highlight some key insights for each area and some avenues for further research, in the hope that this review spurs additional research into these and other areas of importance to both academicians and retail practitioners.

**Renata et al.,** (2007) has examined the Measurement and improvement of e-service quality is important for sustaining competitive advantage of an e-commerce web site. A number of e-service quality measures have recently been developed that predominantly rely on the subjective evaluation of diverse quality attributes. To increase the objectivity of e-service quality measurement a recently developed measure of e-service quality has been adapted in a way that replaces its Likert type scales for evaluation of specific attributes with check-lists that include specific observable elements for appraisal and a scoring procedure. The consistency of scoring with this adaptation of an e-service quality measure was investigated in comparison to the use of the standard measure with Likert type scales and by the use of untrained and trained evaluators. The results of the empirical evaluation indicate a greater inter-rater consistency when the adapted/objective measure is used for evaluation of the efficiency dimension of e-service quality.

**Martinez** (2007) had studied about service quality has focused on customer evaluation. The knowledge of consumer perceptions with regard to this complex construct constitutes powerful information for measuring company performance and for managing strategic projects. This fact is a critical factor in industries, such as the urgent transport service sector, in an environment in which a growth in the number of quality certifications has been prominent in recent years. The development of a valid tool for measuring perceived quality in this specific service has been proposed testing a hierarchical and multidimensional model, where service quality is a higher-order construct underlying four primary dimensions, which are defined by nine sub dimensions. This conceptualization has been conceived after a qualitative research and the literature revision. The authors test this multilevel structure through a series of confirmatory factor analysis based on the partial disaggregation technique, and support the results with the cross-validation study. The implications and limitations of this research are discussed.

## RESEARCH METHODOLOGY

The current research study is both exploratory and descriptive research in nature. The research instrument used in collection of data is an applied questionnaire. The Pilot Study was carried out with the support of a structured questionnaire, which was administered among the sample of 50 respondents. As per the calculations, overall reliability coefficient has surpassed 0.8 and also overall reliability coefficient emerges as a constantly high across total variables. The population of the study is the consumers, who are visiting the retail stores in Coimbatore city. Since the population is infinite, the researcher has taken a sample of 1536, with a confidence level of 95 per cent and a margin of errors of 2.5 per cent. The researcher has considered the De Morgan's sample formula and table to find out the desired sample for the study. The data is fed into SPSS-Statistical Package for Social Sciences-Version 20 and AMOS-Analyzing Momentum of Structures-Version 18. The Analysis was done using the Statistical Tools like Measure of Centre (Mean) and Measure of Dispersion (Standard Deviation).

### Analysis and Interpretation

This section comprises of data analysis, the Measures of Central Tendency and Measures of Dispersion has been displayed below for the service quality of Retail Stores. The respondents agree with the variable "expected - organisational support" with a mean value of 3.64, whereas the respondents disagree with the variable "perceived - organisational support" with a mean value of 1.92. The gap value for the variable is 1.71. The respondents strongly



**Vijayakanthan et al.,**

agree with the variable “expected - employee support” with a mean value of 3.64, whereas the respondents are having a neutral feel with the variable “perceived - employee support” with a mean value of 1.98. The gap value for the variable is 1.66. The respondents strongly agree with the variable “expected - service quality” with a mean value of 3.60, whereas the respondents are having a neutral feel with the variable “perceived - service quality” with a mean value of 1.88. The gap value for the variable is 1.72.

**CONCLUSION**

This final chapter of the report gives a comprehensive view of the study and effectively counters the research questions with support of the research findings. This chapter also gives recommendation for future study and offers an insight on limitations of the study. In order to grasp premium price from the loyal customer, the researcher recommends retailers to improve their retail service quality by (1) designing the shop layout in a manner where it is easy for customers to move around and find what they need; (2) accomplishing the right service at the right time; (3) fascinating and commodious physical facilities; (4) not to over-promise or report unrealistic times for delivery of goods; (5) improve knowledge and ability of employees; (6) empowering employees to handle customer complaints directly and immediately; (7) volitionally handling returns and exchange goods; (8) enhancing ability of employees to solve problems; (9) reacting favourably to customer’s requests; (10) personalized policies like convenient operating hours and ample parking; (11) individual attention to every individual (12) consistently courteous with customers.

**ACKNOWLEDGEMENTS**

Thanks to all the participants who helped us by participating in this research. All the department colleagues who helped us access the departmental set-up for completing this work.

**Conflict of Interest**

The authors certify that, they have had no affliction with or involvement in any organisation or entity with any financial interest, or non-financial interest in subject matter, or material discussed in the manuscript.

**Authors' Contributions**

All authors made a significant contribution to the work reported, whether that is in the conception, study design, execution, acquisition of data, analysis and interpretation; took part in drafting, revising or critically reviewing the article; gave final approval of the version to be published; have agreed on the journal to which the article has been submitted; and agree to be accountable for all aspects of the work.

**Funding Acknowledgements**

The authors have not received any financial support for the current research article and/or for the publication of this article.

**REFERENCES**

1. Parasuraman, *et al.*, “SERVQUAL: A Multiple item Scale for Measuring Customer Perceptions of Service Quality,” *Journal of Retailing*, 64 (1988): pp. 12-14.
2. Parasuraman, V.A. Zeithaml and L.L. Berry (1985), “A Conceptual Model of service Quality and its Implications for Future Research,” *Journal of Marketing*, pp. 41-50.
3. Abhishek Kumar (2018),” SERVICE QUALITY SCALES – A REVIEW”, *SERVICE QUALITY SCALES – A REVIEW* Volume 9, Issue 3,pp. 497-505.
4. M, Sampath Nagi and D, Sathish Kumar (2021), Perception of the Farmers towards the Quality of Service Provided by Co-Operative Banks, *Indian Journal of Natural Sciences (IJONS)*,12:66, 30725-30732.





**Vijayakanthan et al.,**

**Table1: Mean and Standard Deviation of Organisational Support**

Measuring Variables	Expected Service Quality		Perceived Service Quality		Gap
	Mean	Sd	Mean	Sd	
Tangibles	3.67	.524	2.37	.760	1.30
Reliability	3.64	.571	2.10	.938	1.54
Access	3.57	.581	1.79	.713	1.78
Price & Product Variety	3.73	.463	1.88	.949	1.85
<b>Mean Score</b>	<b>3.64</b>	<b>.497</b>	<b>1.92</b>	<b>.850</b>	<b>1.71</b>

**Table 2: Mean and Standard Deviation of Employee Support**

Measuring Variables	Expected Service Quality		Perceived Service Quality		Gap
	Mean	Sd	Mean	Sd	
Responsiveness	3.65	.494	1.95	.859	1.69
Assurance	3.57	.530	1.80	.792	1.77
Empathy	3.57	.548	1.98	.758	1.59
<b>Mean Score</b>	<b>3.64</b>	<b>.689</b>	<b>1.98</b>	<b>.752</b>	<b>1.66</b>

**Table 3: Mean and Standard Deviation of Service Quality**

Measuring Variables	Expected Service Quality		Perceived Service Quality		Gap
	Mean	Sd	Mean	Sd	
Organisational Support	3.64	.497	1.92	.850	1.71
Employee Support	3.64	.689	1.98	.752	1.66
<b>Mean Score</b>	<b>3.60</b>	<b>.696</b>	<b>1.88</b>	<b>.756</b>	<b>1.72</b>



**Fig 1: Mean and Standard Deviation of Organisational Support**



**Fig 2: Mean and Standard Deviation of Employee Support**



**Fig 3: Mean and Standard Deviation of Service Quality**





## To Evaluate the Properties of Concrete Including using Oyster Shell Powder in Place of Cement

Maneeth P D<sup>1\*</sup>, Shreenivas Reddy Shahapur<sup>2</sup>, Shivaraj SJ<sup>3</sup> and G Sridevi<sup>4</sup>

<sup>1</sup>Assistant Professor, Department of Civil Engineering, Visvesvaraya Technological University, Gulbarga-585105, Karnataka. India

<sup>2</sup>Professor, Department of Civil Engineering, Visvesvaraya Technological University, Gulbarga-585105, Karnataka, India.

<sup>3</sup>Assistant Professor, Department of Civil Engineering, B. V.Raju Institute of Technology, Vishnupur, Narsapur, Medak-502313. Telangana, India.

<sup>4</sup>Professor, Department of Civil Engineering, B. V. Raju Institute of Technology, Vishnupur, Narsapur, Medak-502313, Telangana, India.

Received: 26 Oct 2021

Revised: 29 Nov 2021

Accepted: 07 Jan 2022

### \*Address for Correspondence

#### Maneeth P D

Assistant Professor,  
Department of Civil Engineering,  
Visvesvaraya Technological University,  
Gulbarga-585105, Karnataka. India  
Email: maneeth.pd@gmail.com



This is an Open Access Journal / article distributed under the terms of the **Creative Commons Attribution License** (CC BY-NC-ND 3.0) which permits unrestricted use, distribution, and reproduction in any medium, provided the original work is properly cited. All rights reserved.

### ABSTRACT

Cement Concrete is a mixture of cement, FA, and CA, as well as water. Concrete undertakes an essential fragment in the progress of frameworks like structure modern designs, spans, and expressways, and so on Prompting human progress to an enormous quantity of cement on the other side, the expense of cement is credited to the expense of its fixings which is scant and expensive, subsequently inflaming use financially elective material in its creation. This condition has pinched the attention of examination to explore the new exchange of elements of cement. The current specific report canter around exploring attributes of cement with replacement of cement with oyster shell powder at a rate of 1-5 percent. This is an eco-accommodating method of using the item without unloading it on the ground. The exploratory investigation has been performed to assess the workability and properties of high strength solidified cement concrete by partial supplanting the cement with oyster shell powder at a rate of 1%, 2%, 3%, 4%, and 5% for 7 days, 14 days, and 28 days of restoring period.

**Keywords:** Oyster shell powder, workability, solidified cement concrete



**Maneeth et al.,**

## INTRODUCTION

The current pattern in roadway designing is moving toward the economical angles because of the consumption of characteristic solid making materials just as the ecological effect emerging from the usage of these materials the creation of solid materials like CA, FA, and cement delivers harmful gases and causes CO<sub>2</sub> outflow. In taking into account these ecological viewpoints, natural well-disposed material can be utilized in solid which doesn't discharge ozone harming substances. OS ash is utilized in this investigation. The Oyster shell doesn't disintegrate and lessens CO<sub>2</sub> emanation in the solid. The accessibility of shells in the seaside territory is a huge amount. Since these shells don't go under decay land filling is additionally not be conceivable. A little amount of shell is utilized for handcrafts and as compost. There are issues with the illicit unloading of these waste shells into public water and recovered the land. Utilizing this item as a fake stone addresses an advancement in the Oyster Shell Powder: Oyster shells have extremely strong adductor muscles to close their shells when threatened. They do not decompose and do not release greenhouse gases. Oyster grit could do a great deal to reduce CO<sub>2</sub>. Oyster shells have a high amount of calcium. These oppose the substance assault on concrete and accomplish a degree of extreme strength, usefulness when contrast with ordinary blends.

### Intention of Investigation

Intention beyond this present investigation is to evaluate the mechanical analysis of oncrete made by the replacement of oyster shell powder i.e, compressive, tensile and flexural strength in various proportions.

### Purview of the Work

The purview of investigation was to produce concrete of M55 grade by replacing oyster shell powder with cement at various portions of 0%, 1%, 2%, 3%, 4%, 5% and by maintain 1% of super-plasticizer and evaluate conducting various tests.

### Experimental Programme

To fulfill the study's aims, a comprehensive experimental program was developed. The investigation's experimental methods are explained further down.

## MATERIALS AND PROPERTIES

By validating the standard as per IS 1489(Part1):2015, Portland pozzolonic cement of ACC company was brought from the market of Kalaburagi for testing. To aid in the experiment, oyster shell powder was obtained from Gujarat. Fine aggregates have a size of 4.75mm or less was considered. For the project, crushed stone (angular) of 20mm down size was acquired from neighbouring quarry of Kalaburagi industrial area. For the creation of the mixes and the curing process, ordinary portable water was used. From the local market of Kalaburagi, Master Ease 3705 was utilised as a super plasticizer. Following the test protocols, the physical properties of binders, such as PPC and oyster shell powder, were examined.

### Concrete Mix Design

To create six different concrete mixes which includes the control concrete, is required to achieve the goal of producing high strength concrete using oyster shell powder. PPC, aggregates, and water were used in the control concrete mix, which was developed as per IS10262 (2019).



**Maneeth et al.,**

Effective w/c ratio was 0.32, although super plasticizer was added to keep the slump in a handle able range. By mass, PPC was substituted with 1, 2, 3, 4, and 5 % with oyster to create mixes. By enhancing the super-plasticizer content with OS powder with-out changing the effective w/b ratio, the workability was maintained (0.32). Master Ease 3705 has been utilised as super plasticizer.

### **Specimen Casting and Curing**

The ingredients were carefully combined in the concrete mixer in the first stage to achieve a homogeneous solid mixture. The necessary water was then actually introduced to the solid mixture and well stirred for another 5-6 minutes to make an uniform wet mix. During the mixing phase, the super plasticizer was poured in with the water. The freshly prepared concrete was slump tested and its workability was validated after the mixing procedure. After the workable concrete had been made, it was poured into various moulds such as cubes, cylinders, and prisms to create concrete specimens. The new concrete was poured in three layers in the mould and compacted with the requisite blows by the tamper. The specimens were taken from the moulds after 24 hours of casting and placed in water to cure until they achieved the proper age.

### **Procedures Considered for Testing**

Specific test methods were used to determine the mechanical parameters of the concrete created by introducing oyster shell powder with cement, to evaluate the parameters such as compressive, splitting tensile, and flexural strength, of 7, 14, and 28 days post curing, while using applicable IS codes. 150 mm cube models were evaluated at a 2000 kN compression testing equipment at a steady incremental loading of 14 N/mm<sup>2</sup>/min until the specimen failed to absorb the compressive load. The compressive test was used to calculate the tensile strength of the said specimen at 7, 14, and 28 days of curing, with dimensions of 150 mm dia & 300 mm height. The flexural strength of prism moulds with dimensions of 150 x 150 x 500 mm was considered, two point loads were applied to the specimen after 7, 14, and 28 days of curing.

## **RESULTS AND DISCUSSIONS**

The research has been done to investigate different qualities of M55 grade concrete mix by adding oyster shell powder and incorporating super plasticizer with a w/b ratio of 0.32, & the findings were determined after 7,14 and 28 days of curing. The prepared concrete mixes' workability findings (slump and compaction factor) are shown. The use of oyster shell powder and superplasticizer improves the workability of concrete mixes. The compressive strength increased up to 3% with the substitute of oyster shell powder in the studies, and afterwards the strength values decreased.

## **CONCLUSION**

1. The slump and compaction factor values increases due to 1%-5% replacement of oyster shell powder and 1% super plasticizer.
2. The workable property of fresh concrete increases with addition of OS powder and super plasticizer.
3. When compared to ordinary concrete, the results show that the concrete has superior compression, split tensile and flexural strength.
4. It has been discovered that up to 3% of the cement can be substituted with OS dust.





**Maneeth et al.,**

5. The study shown that the compression strength at 28 days is more up to 3% replacement and gives higher strength of curing at 28 days.
6. The results reveal that the OS dust improves strength by 3%, then decreases strength attributes by 4% and 5%.

## REFERENCES

1. Bhushan.B.Garad, Jayvant Paturde, Dr.Valsson Verghese (2019), "Experimental Investigation on Strength of Concrete by Partial Replacement of Cement by Oyster Shell Powder", *Int. J. for Res. in App. Sci. & Eng. Tech.*, 4(7), 1-6.
2. Binag, Dr. Noel.D., (2016), "Powdered Shell Wastes as Partial Substitute for Masonry Cement Mortar in Binder, Tiles and Brick Production", *Int. J. of Eng. Res. & Tech.*, (5), 1-8.
3. Ephraim.M.E,Thank.God.O,Gbinu.K.S.,(2019), "Performance of high Strength Concrete Using Oyster Shell Ash as Partial Replacement for Cement" *Int. J. of Civil Eng.*, 6, 1-6.
4. Gil-Lim.Yoon.Byung-Tak.Kim,Baek-Oon.Kim,Sang-Hun.Han, (2002), "Chemical-mechanical characteristics of crushed oyster-shell", *Coastal & Harbor Engineering Research Division, Korea Ocean Research & Development Institute, South Korea*, 1-11.
5. Hene L. Hapinat, Eva S. Montero, (2018), "Development of Concrete Hollow Blocks from Pulverized Oyster Shell (*Crassostrea iredalei*) and Non-Biodegradable Materials" *Int. J. of Sci. & Res.*, 08.
6. Joon.Ho.Seo, Sol.Moi.Park, Beom.Joo.Yang, Jeong.Gook.Jang., (2019) "Calcined Oyster Shell Powder as an Expansive Additive in Cement Mortar". *Dept. of Civil and Envi. Eng, Korea Adv. Inst. of Sci. & Tech.*, 1-12.
7. Khekiye.Aye,Khatele.Kenye,E.Nainar,Akenyu Khing, Chelila Sangtam.,(2019), "Strengthening of Concrete by using Oyster Shell and Marble Powder", *Int. J. of Rec. Tech. & Eng.*, 4(8), 1-5.
8. kim Hung MO, Mohd Zamin Jumaat,U.Johnson Alengaram,Wan Inn Goh.Choon Wah Yuen, (2018), "Recycling of seashell waste in concrete" *Dept. of Civil Eng., University of Malaysia*, 1-15.
9. S. Erni H. Gagoek, K. Purwanto., (2016), "Green Concrete Made Of Oyster Shell Waste To Support Green Building Material" *J. Teknologi (Sci. & Eng.)*,1-6.
10. S.Abinaya, S.Prasanna venkatesh, (2016), "An Effect on Oyster Shell Powder's Mechanical Properties in Self Compacting Concrete". *Int. J. of Inno. Res. in Sci. Eng. & Tech.*, 5, 1-5.

**Table1: Chemical Composition of PPC Cement**

Components	Si O <sub>2</sub>	Al <sub>2</sub> O <sub>3</sub>	Fe <sub>2</sub> O <sub>3</sub>	Mg O	S O <sub>3</sub>	Ca O	Na <sub>2</sub> O	K <sub>2</sub> O
Concentration (%)	29.67	8.67	3.80	1.88	2.19	40.95	0.28	0.84

**Table2: Properties of Cement Used**

SI.NO	Test performed	Obtained Values	IS 1489(Part1):2015 Recommendation
1)	Normal consistency (%)	30.6	-
2)	Initial setting time	115min	Not <30min
3)	Final setting time	325min	Not <600min
4)	The Fineness of cement(m <sup>2</sup> /kg)	2.1%	Not <10%
5)	Compressive strength at 28 days	57MPa	Not < 33





**Maneeth et al.,**

**Table 3: Chemical Composition of Oyster Shell Dust:**

Components	Ca CO <sub>3</sub>	Si O <sub>3</sub>	Mg O	Al <sub>2</sub> O <sub>3</sub>	Sr O	P <sub>2</sub> O <sub>5</sub>	Na <sub>2</sub> O	SO <sub>3</sub>
Concentration(%)	88.98	4.05	0.65	0.42	0.32	0.201	0.88	0.73

**Table 4: Properties of OS Powder Used:**

Oyster shells	Less than 90 micron
Specific Gravity	2.61
Fineness Modulus	2.23

**Table5: Basic Experiments of Fine Aggregate Used**

Sl.No.	Test Performed	Obtained Results	IS:383:2016 Recommendation
1	Maximum size	<4.75mm	<4.75mm
2		2.65	2.65-2.7
3	Bulk Density (kg/m <sup>3</sup> ) Loose condition Unloose condition	1475 1670	1520-1750
4	Fineness modulus	2.79	<3.0%
5	Silt content in %	1.19%	<3.0%
6	Water absorption	0.73%	-

**Table 6: Basic Experiments of Coarse Aggregate Used:**

Sl.NO	Test Performed	Obtained Results	Specifications	Reference
1	Specific Gravity	2.68	2.4-2.9	IS:2386(part3)2016
2	Bulk Density(kg/m <sup>3</sup> ) Loose condition Unloose condition	1460 1560	1520-1680	
3	Flakiness index	23.42%	<35%	IS:2386(part1)-2016
4	Elongation index	35.74%	35-45%	IS:2386(part1)-2016
5	Water absorption	2.05%	2% (Max)	IS:2386(part3)-2016
6	Crushing value	20.07	30%(Max)	IS:2386(part4)-2016
7	Los Angeles Abrasion value	27.98	30% (Max)	IS:2386(part4)-2016
8	Impact value	10.89%	24% (Max)	IS:2386(part4)-2016

**Table7: Compression Strength of Cubes:**

Sl.NO	Curing Period(Days)	Oyster Shell (%)	Superplasticizer (%)	Compressive Strength(N/mm <sup>2</sup> )
1	7	0%	1	33.44
2	7	1%	1	33.43
3	7	2%	1	34.35
4	7	3%	1	36.20
5	7	4%	1	32.90
6	7	5%	1	32.10
7	14	0%	1	45.32
8	14	1%	1	45.96
9	14	2%	1	46.20
10	14	3%	1	47.32
11	14	4%	1	46.78
12	14	5%	1	46.67
13	28	0%	1	50.98







**Maneeth et al.,**

14	28	1%	1	52.56
15	28	2%	1	55.77
16	28	3%	1	57.56
17	28	4%	1	53.76
18	28	5%	1	52.10

**Table8: Split Tensile Strength Of Cylinder**

Sl.NO	Curing Period(days)	Oyster Shell (%)	Superplasticizer (%)	Split Tensile Strength(N/mm <sup>2</sup> )
1	7	0%	1	2.76
2	7	1%	1	2.79
3	7	2%	1	2.81
4	7	3%	1	2.94
5	7	4%	1	2.72
6	7	5%	1	2.53
7	14	0%	1	3.76
8	14	1%	1	3.79
9	14	2%	1	3.82
10	14	3%	1	3.90
11	14	4%	1	3.74
12	14	5%	1	3.63
13	28	0%	1	4.12
14	28	1%	1	4.30
15	28	2%	1	4.54
16	28	3%	1	4.75
17	28	4%	1	4.21
18	28	5%	1	4.11

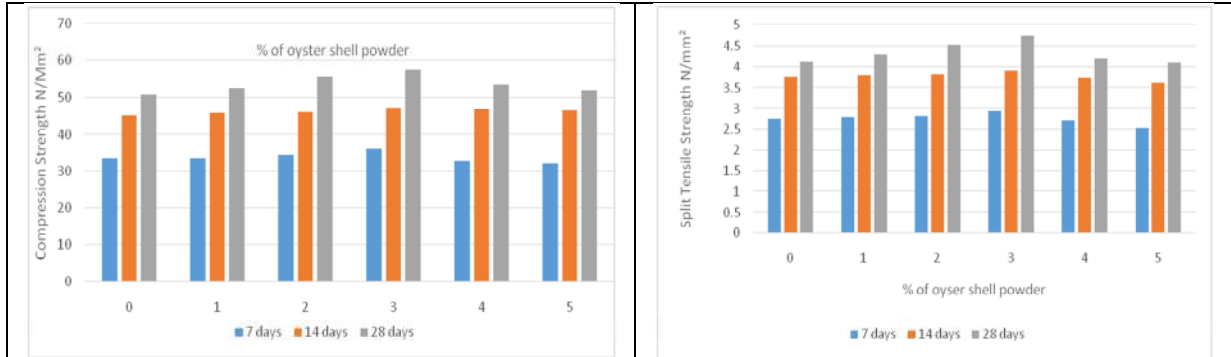
**Table9: Flexural Strength of Beam:**

SL.No	Curing Period(Days)	Oyster Shell (%)	Superplasticizer (%)	Flexural Strength(N/Mm <sup>2</sup> )
1	7	0%	1	4.03
2	7	1%	1	4.02
3	7	2%	1	4.13
4	7	3%	1	4.5
5	7	4%	1	4.12
6	7	5%	1	4.2
7	14	0%	1	5.44
8	14	1%	1	5.52
9	14	2%	1	5.55
10	14	3%	1	5.68
11	14	4%	1	5.52
12	14	5%	1	5.49
13	28	0%	1	6.23
14	28	1%	1	6.30
15	28	2%	1	6.68
16	28	3%	1	6.98
17	28	4%	1	6.43
18	28	5%	1	6.23



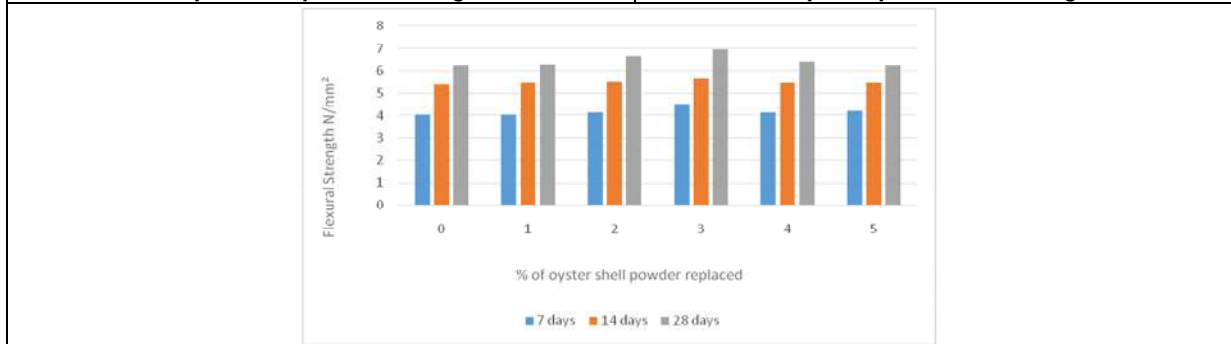


**Maneeth et al.,**



**Graph 1. Compression strength**

**Graph 2. Split Tensile Strength**



**Graph 3. Flexural Strength**





## Determinants of Intentions to use mHealth Apps for Meditation

Devanshi Padaliya<sup>1</sup>, Bhavana Arya<sup>2\*</sup> and Shriparna Singh<sup>3</sup>

<sup>1</sup>Research Scholar, Department of Psychology, Manipal University Jaipur, Jaipur, India.

<sup>2</sup>Department of Psychology, Manipal University Jaipur, Jaipur, India

<sup>3</sup>Assistant Professor, The Bishop's School, Camp Pune, Maharashtra, India

Received: 29 Oct 2021

Revised: 15 Nov 2021

Accepted: 07 Jan 2022

### \*Address for Correspondence

**Bhavana Arya**

Department of Psychology,

Manipal University Jaipur,

Jaipur, India

Email: bhavana.jaipur@gmail.com



This is an Open Access Journal / article distributed under the terms of the **Creative Commons Attribution License** (CC BY-NC-ND 3.0) which permits unrestricted use, distribution, and reproduction in any medium, provided the original work is properly cited. All rights reserved.

### ABSTRACT

The purpose of this study is to investigate the determinants of intentions to use mHealth apps for the purpose of meditation. With the pervasiveness of smartphones and increasing interest in mHealth, it is necessary to understand the factors contributing to usage intentions towards apps for self-care and behavior change. The proposed model is informed by the technology acceptance models and health related beliefs of individuals. This study used quantitative methods in which performance expectancy, effort expectancy, social influence, facilitating conditions, perceived susceptibility, perceived severity, and self-efficacy beliefs were used to predict the intention to use mobile apps for meditation. Data were collected through Microsoft forms by a self-administered questionnaire which was circulated through various social media platforms. The integrative viewpoint confirms that health beliefs add significant explained variance to intention.

**Keywords:** mHealth, meditation, UTAUT, self-efficacy, perceived threat.

## INTRODUCTION

mHealth is defined as use of mobile and wireless technologies to support the achievement of health objectives. by [1], [2] defines mHealth as "the use of mobile and wireless devices (cell phones, tablets, etc.) to improve health outcomes, health care services, and health research." mHealth services are used for prevention of diseases, promotion of healthy behaviours, management and delivery of healthcare services and also for surveillance. With the technological advances in mobile technologies and 5G network, and the rapid integration of mHealth into the existing eHealth, the future for mHealth looks promising. Due to high penetration of smartphones and availability of mHealth apps for health and wellbeing, there is a huge possibility to improve the accessibility to healthcare [3] by developing app based interventions [4].





**Devanshi Padaliya et al.,**

Due to a variety of physical, environmental and lifestyle factors there is a tremendous rise in chronic diseases placed under the category of lifestyle disorders. Unhealthy practices like smoking, physical inactivity, sleep disturbance, excessive stress and anxiety has been identified as a leading cause of many mental health problems[5]. Modification in one's lifestyle is fundamental for the development of their holistic health [6]. Looking at the ubiquitous presence of mobile applications in day-to-day life, mHealth apps for management and self-care can play an important role in bringing about healthy changes in lifestyle. MHealth applications are classified into two categories: medical apps which are disease specific and are used for management of diseases and health and wellbeing apps which aim at bringing about behavioural change [7]. Thus the major objectives of the current research are to identify the factors that affect the adoption and usage of mobile applications to meditate and to study the impact of these factors on the intention to practice app based meditation.

### **THEORETICAL BACKGROUND**

For voluntary use it is important that people have the intention to adopt and use technology. A review of literature informs that technology acceptance is majorly influenced by factors specific to technology (usability, cost, availability, efficacy), felt need to use technology (beliefs about the target behaviour) and social influences. Existing research in mHealth mainly focuses on medical apps and explores the intention to use mHealth within the framework of technology acceptance. Also there is insufficient research which explores effective use of self-care mHealth apps [8]. Therefore the authors concluded that research is required to understand the use of mHealth apps for behaviour change which takes into consideration the existing framework of technology acceptance and health related beliefs of individuals. mHealth applications that help to meditate can be considered under the category of apps which support behaviour change. Currently there are many mobile applications available in the category of 'meditation apps' on the Google play store and the Apple app store. Use of mHealth applications for meditation is a cost effective and easily accessible resource available to people to improve their lifestyle [9].

People who value their health and put a consistent effort towards the management and maintenance of their wellbeing are more likely to use mobile application for meditation.[10] mHealth apps for meditation have been used to effectively treat fatigue and daytime sleepiness by adults between 18 to 96 years of age. [11] Mental health concern of adults like self-diagnosed- stress, anxiety and depression have also been seen to reduce after the usage of meditation mHealth apps like Calm. Adult population between the age of 18 to 65 also depicted an improvement in their overall health after the use of mHealth apps for meditation.[12]. Indulging in health promoting behavior like meditation and physical activity tends to reduce the worsening condition of mental health[13]. Guided meditation mHealth applications like Calm and headspace have proven to be effective in developing self compassion along with self-management of wellbeing. [14] and individuals who use these apps frequently are more likely to maintain the progress of their mental health [15].

The usage of these mHealth apps could be of great value to the Indian health care system and will contribute to the Sustainable Developmental Goals (SDG). However the adoption and usage of such apps is still very low and faces challenges in the term of technology acceptance by people[8]. Theoretical framework for the current research is informed by technology adoption and health beliefs. The Unified Theory of Acceptance and Use of Technology (UTAUT) is a framework to explain technology acceptance. The framework is informed by many other existing theories which explain behavioural intentions to adopt technology. UTAUT [16] has four constructs: performance expectancy (PE), effort expectancy (EE), social influence (SI) and facilitating conditions (FC) which predict behavioural intentions (BI). According to UTAUT PE is users' belief about the positive impact of technology, EE is the ease associated with technology use, SI refers to normative beliefs about technology usage and FC refer to contextual factors which support the usage of technology. BI is the outcome variable which refers to the intentions to adopt technology in near future. In the current study UTAUT constructs are conceptualised as follows:

PE refers to the users' belief about the extent to which using mobile applications to meditate will be helpful in practicing meditation.

EE refers to the beliefs about the ease of using apps for meditating.

SE refers to the perceived importance of the opinion of significant others (family members, peers,





Devanshi Padaliya et al.,

friends) pertaining to the use of mobile applications for meditating.

FC refers to subjective beliefs about technological support available to use the mobile applications for meditating.

BI refers to the perceived intention to use an app for meditation.

UTAUT has been used to understand mHealth services by many researchers and it was seen that PE [17], EE [18], SI [19] and FC [20] had a significant influence on adoption of mHealth apps, for both physical activity and medical condition.[21] [22]

Accordingly, the following hypotheses were framed:

H1: PE has a significant impact on users' intention to use mobile applications for meditating

H2: EE has a significant impact on users' intention to use mobile applications for meditating

H3: FC has a significant impact on users' intention to use mobile applications for meditating

H4: SI will significantly impact users' intention to use mobile applications for meditating

However, individual differences in intention to use mobile phone applications for the purpose of practicing meditation cannot be fully explained in terms of technology acceptance. Since meditation is a health promoting activity, one needs to look for factors which promote behaviour change and health beliefs. Health behaviours are importantly influenced by the felt need to promote and maintain health status. Such behaviours are regardless of the current actual or perceived status of the individual [23].

#### Beliefs and Health Related Behavior

Health beliefs are based subjective perceptions about health, illness and ways and individual ability to overcome an illness. The Health Belief Model (HBM) provides a useful framework to understand the motivation of individuals to engage in health behaviours. HBM was created to understand the individual and situational factors associated with preventive care [24]. HBM is based on the premise that "primary prevention is economically and socially less expensive than sickness care," [25]. The important constructs of HBM are: perceived susceptibility (PS) which refers to an individual's belief that they are vulnerable to contracting a disease or could be a carrier of a trait, perceived severity (PS) which refers to belief that contracting a disease or carrying a trait would negatively impact their life, self-efficacy (SE) which is a belief in the ability of the self to bring about a health related change, perceived benefits (PB) which measure individual belief that their actions will help them maintain good health and avoid contracting a disease and perceived barriers (PB) which are individual's expectation that he will experience negative consequences when he takes a certain action [26]. An individual may have trouble making a decision because he fears he might experience issues such as inconvenience, pain, embarrassment, or financial cost.

HBM [27,28] suggests that perceived susceptibility and perceived risk are important in being predisposed towards preventive action [29]. The more health risk perceived by an individual the more likely they take health oriented actions [30]. In a study, it was found that women who are concerned about their health proactively engage in health-related internet use. Individual self- efficacy beliefs are also known to have a significant influence on health-related behaviours [31]. Thus PV ,PS and SE are the main constructs of HBM which form the core of beliefs related to risk and individual ability to engage in behaviour. These constructs are conceptualised in the current study as follows:

PV refers to individual perceptions of being susceptible to a chronic health condition.

PS refers to individual beliefs about the seriousness of the chronic health condition.

SE refers to the users' confidence in their ability to use mobile phone applications for meditation.

Hypotheses for the constructs are as follows:

H5: PV has a significant impact on users' intention to use mobile applications for meditating

H6: PS has a significant impact on users' intention to use mobile applications for meditating

H7: SE has a significant impact on users' intention to use mobile applications for meditating

The proposed model based on the integration of constructs from UTAUT and health belief model is shown in figure 1.





## METHODOLOGY

A cross-sectional survey was used to measure the intention to use and actual usage of mobile applications for practicing meditation.

### Sample and Procedure

Define The target population were users of smartphone who were above the age of 18 years and had downloaded at least one application for practicing guided meditation in the past 3 months. The sample consisted of Indian citizens who fit the criterion and completed the survey questionnaire. Microsoft forms were used to collect data through convenient sampling method. Potential participants were contacted through various online platforms. The interested participants responded by reading the purpose of the research and expressing willingness to be a part of the research. Before presenting the actual questionnaire, two screening questions were asked to ascertain the inclusion criterion of age (more than 18) and having downloaded an application on their smartphone for practicing guided meditation in the past three months. Those who were eligible were presented with the questionnaire. The completion of the questionnaire was taken as consent provided by the participants. Data were collected from 15 January, 2021 to 30 March 2021.

### Measuring Scales

Data were collected using a self-administered questionnaire developed for the study. To develop the questionnaire related studies on mHealth adoption were consulted [32] [33] [34]. The questionnaire consisted of two parts. The first part collected demographic details (age, sex and educational qualification, of the participants). The second part collected data for the UTAUT construct items (Performance Expectancy, Effort Expectancy, Social Influence, Facilitating Conditions, Usage Intention) and HBM constructs (Perceived vulnerability, perceived risk and Self-efficacy). Thus the study had a total of seven predictor variables and one dependent variable. All items in part two were measured on a five point Likert scale ranging from "Strongly Agree" to "Strongly Disagree".

### Data Analysis

Data were analysed using SPSS 22.0. Hierarchical linear regression was carried out to investigate the impact of independent variables on the dependent variable.

## RESULTS AND DISCUSSION

A total of 397 participants voluntarily completed the survey. Out of the 397 filled questionnaires 68 were rejected due to poor data quality. The remaining 329 filled questionnaires were considered for further analysis. Sample characteristics are shown in table 1.

Internal consistency of all the scales was measured using Cronbach's alpha. The alpha value for all the scales was greater than 0.7, indicating good internal consistency.

### Regression Model

To test the model BI was regressed onto UTAUT constructs and health beliefs. Table 3 shows a 2-step hierarchical linear regression analysis of BI to use mobile application for meditation. Sex, age and education were entered into the first block. PE, EE, SI and FC were entered into the first block. PE, EE, SI and FC were entered into the second block. PV, PS and SE were entered in the last step.

According to the model summary step 1 was significant ( $F(7, 321) = 16.28, p < .01$ ) and the UTAUT variables accounted for 44% variance in BI. Model 2 with health belief constructs added at step 3 was also significant ( $F(10, 318) = 13.61, p < .01$ ). Step 2 explained an additional 9% variance in BI. Overall, the conceptual model accounted for a total of 54% variance in BI.





**Devanshi Padaliya et al.,**

According to the regression analysis, EE, FC, PV and SE emerged as the most crucial factors that impacted the intentions to use mobile applications for meditation. Hypotheses H1, H2, H3, H5 and H7 were supported by the results. This was consistent with previous findings [35] [36]. This means that individual perceptions of the efforts required to use such apps, the perceived efficiency of such apps to help in meditating and presence of favourable conditions like availability of technical knowledge play an important role in shaping the intentions to use these apps. Also self-perceptions of being vulnerable to mental health conditions and a sense of efficacy in being able to meditate also play a role in setting intentions to meditate using such apps. Similar findings have been reported by other researches on factors contributing to acceptance of technology for healthcare [37].

## REFERENCES

1. mHealth: New horizons for health through mobile technologie. (2021, August 10). WHO Regional Office for Africa. <https://www.afro.who.int/publications/mhealth-new-horizons-health-t-through-mobile-technologie>
2. Mobile Health Technology and Outcomes in LMICs (R21 R33) - Fogarty International Center @ NIH. (n.d.). Fogarty International Center. Retrieved August 12, 2021, from <https://www.fic.nih.gov/Programs/Pages/mhealth.aspx>
3. Meeker M, Wu L. RMS Media: The Media Specialists. 2013. [2020- 04-14]. Internet Trends: D11 Conference <https://rmsmedia.co.za/wp-content/uploads/2013/08/Mary-Meeker-Internet-Trends-052913-final.pdf>.
4. Akbar, S., Coiera, E., Magrabi, F. (2020). Safety concerns with consumer-facing mobile health applications and their consequences: a scoping review. *Journal of the American Medical Informatics Association*, 27(2), 330–340.
5. Mental health and COVID-19. (2021, June 1). World Health Organisation.Int. <https://www.who.int/teams/mental-health-and-substance-use/covid-19>
6. Nyenhuis, S. M., Dixon, A. E., Ma, J. (2018). Impact of Lifestyle Interventions Targeting Healthy Diet, Physical Activity, and Weight Loss on Asthma in Adults: What Is the Evidence? *The Journal of Allergy and Clinical Immunology: In Practice*, 6(3), 751–763. <https://doi.org/10.1016/j.jaip.2017.10.026>
7. Helbostad, J., Vereijken, B., Becker, C., Todd, C., Taraldsen, K., Pijnappels, M., Aminian, K., Mellone, S. (2017). Mobile Health Applications to Promote Active and Healthy Ageing. *Sensors*, 17(3), 622. <https://doi.org/10.3390/s17030622>
8. Cho, J. (2016). The impact of post-adoption beliefs on the continued use of health apps. *International Journal of Medical Informatics*, 87, 75–83. <https://doi.org/10.1016/j.ijmedinf.2015.12.016>
9. Huberty, J. L., Green, J., Puzia, M. E., Larkey, L., Laird, B., Vranceanu, A. M., Vlisides-Henry, R., Irwin, M. R. (2021). Testing a mindfulness meditation mobile app for the treatment of sleep-related symptoms in adults with sleep disturbance: A randomized controlled trial. *PLOS ONE*, 16(1), e0244717. <https://doi.org/10.1371/journal.pone.0244717>
10. Mohr, D. C., Burns, M. N., Schueller, S. M., Clarke, G., Klinkman, M. (2013b). Behavioral Intervention Technologies: Evidence review and recommendations for future research in mental health. *General Hospital Psychiatry*, 35(4), 332–338. <https://doi.org/10.1016/j.genhosppsych.2013.03.008>
11. Green, J., Huberty, J., Puzia, M., Stecher, C. (2021). The Effect of Meditation and Physical Activity on the Mental Health Impact of COVID-19–Related Stress and Attention to News Among Mobile App Users in the United States: Cross-sectional Survey. *JMIR Mental Health*, 8(4), e28479. <https://doi.org/10.2196/28479>
12. Huberty, J., Green, J., Glissmann, C., Larkey, L., Puzia, M., Lee, C. (2019). Efficacy of the Mindfulness Meditation Mobile App “Calm” to Reduce Stress Among College Students: Randomized Controlled Trial. *JMIR MHealth and UHealth*, 7(6), e14273. <https://doi.org/10.2196/14273>
13. Flett, J. A. M., Hayne, H., Riordan, B. C., Thompson, L. M., & Conner, T. S. (2018). Mobile Mindfulness Meditation: a Randomised Controlled Trial of the Effect of Two Popular Apps on Mental Health. *Mindfulness*, 10(5), 863–876. <https://doi.org/10.1007/s12671-018-1050-9>
14. Green, J., Huberty, J., Puzia, M., Stecher, C. (2021b). The Effect of Meditation and Physical Activity on the Mental Health Impact of COVID-19–Related Stress and Attention to News Among Mobile App Users in the United States: Cross-sectional Survey. *JMIR Mental Health*, 8(4), e28479. <https://doi.org/10.2196/28479>



**Devanshi Padaliya et al.,**

15. Firth, J., Torous, J., Nicholas, J., Carney, R., Prata, A., Rosenbaum, S., Sarris, J. (2017). The efficacy of smartphone-based mental health interventions for depressive symptoms: a meta-analysis of randomized controlled trials. *World Psychiatry*, 16(3), 287–298. <https://doi.org/10.1002/wps.20472>
16. Venkatesh, Morris, Davis, ; Davis. (2003). User Acceptance of Information Technology: Toward a Unified View. *MIS Quarterly*, 27(3), 425. <https://doi.org/10.2307/30036540>
17. Shyh-Chang, N., Daley, G. Q., Cantley, L. C. (2013). Stem cell metabolism in tissue development and aging. *Development*, 140(12), 2535–2547. <https://doi.org/10.1242/dev.091777>
18. Ndayizigamiye, P., Maharaj, M. (2016). Mobile health adoption in Burundi: A UTAUT perspective. 2016 IEEE Global Humanitarian Technology Conference (GHTC). Published. <https://doi.org/10.1109/ghtc.2016.7857342>
19. van Woudenberg, T. J., Simoski, B., Fernandes De Mello Araújo, E., Bevelander, K. E., Burk, W. J., Smit, C. R., Buijs, L., Klein, M., & Buijzen, M. (2019). Identifying Influence Agents That Promote Physical Activity Through the Simulation of Social Network Interventions: Agent-Based Modeling Study. *Journal of Medical Internet Research*, 21(8), e12914. <https://doi.org/10.2196/12914>
20. Lee, R. A., Jung, M. E. (2018). Evaluation of an mHealth App (DeStressify) on University Students' Mental Health: Pilot Trial. *JMIR Mental Health*, 5(1), e2. <https://doi.org/10.2196/mental.8324>
21. Alam, M. Z. (2018). mHealth in Bangladesh: Current Status and Future Development. *The International Technology Management Review*, 7(2), 112. <https://doi.org/10.2991/itm.2018.7.2.1>
22. Ndayizigamiye, P., Kante, M., Shingwenyana, S. (2020). An adoption model of mHealth applications that promote physical activity. *Cogent Psychology*, 7(1), 1764703. <https://doi.org/10.1080/23311908.2020.1764703>
23. J. (n.d.). What are the factors, strengths, and weaknesses of the health belief model? - eNotes.com. ENotes. Retrieved August 12, 2021, from <https://www.enotes.com/homework-help/what-are-the-factors-strengths-and-weaknesses-of-252015>
24. Janz, N. K., Becker, M. H. (1984). The Health Belief Model: A Decade Later. *Health Education Quarterly*, 11(1), 1–47. <https://doi.org/10.1177/109019818401100101>
25. Rosenstock, I. M. (1974). Historical Origins of the Health Belief Model. *Health Education Monographs*, 2(4), 328–335. <https://doi.org/10.1177/109019817400200403>
26. Champion, V. L. (1984). Instrument development for health belief model constructs. *Advances in Nursing Science*, 6(3), 73–85. <https://doi.org/10.1097/00012272-198404000-00011>
27. Orji, R., Vassileva, J., Mandryk, R. (2012). Towards an Effective Health Interventions Design: An Extension of the Health Belief Model. *Online Journal of Public Health Informatics*, 4(3). <https://doi.org/10.5210/objphi.v4i3.4321>
28. Rosenstock, I. M., Strecher, V. J., Becker, M. H. (1988). Social Learning Theory and the Health Belief Model. *Health Education Quarterly*, 15(2), 175–183. <https://doi.org/10.1177/109019818801500203>
29. Huberty, J., Vranceanu, A. M., Carney, C., Breus, M., Gordon, M., Puzia, M. E. (2019). Characteristics and Usage Patterns Among 12,151 Paid Subscribers of the Calm Meditation App: Cross-Sectional Survey. *JMIR MHealth and UHealth*, 7(11), e15648. <https://doi.org/10.2196/15648>
30. Kellen, M. K., ; Saxena, D. (2020). Calm my Headspace: Motivations and Barriers for Adoption and Usage of Meditation Apps during Times of Crisis. *ICEB 2020 Proceedings*. 43. <https://aisel.aisnet.org/iceb2020/43>
31. Ahadzadeh, A. S., Pahlevan Sharif, S., Ong, F. S., Khong, K. W. (2015). Integrating Health Belief Model and Technology Acceptance Model: An Investigation of Health-Related Internet Use. *Journal of Medical Internet Research*, 17(2), e45. <https://doi.org/10.2196/jmir.3564>
32. Koopman, R. J., Petroski, G. F., Canfield, S. M., Stuppy, J. A., Mehr, D. R. (2014). Development of the PRE-HIT instrument: patient readiness to engage in health information technology. *BMC Family Practice*, 15(1). <https://doi.org/10.1186/1471-2296-15-18>
33. Yu, P., Li, H., Gagnon, M. P. (2009). Health IT acceptance factors in long-term care facilities: A cross-sectional survey. *International Journal of Medical Informatics*, 78(4), 219–229. <https://doi.org/10.1016/j.ijmedinf.2008.07.006>
34. Dwivedi, Y. K., Shareef, M. A., Simintiras, A. C., Lal, B., ; Weerakkody, V. (2016). A generalised adoption model for services: A cross-country comparison of mobile health (m-health). *Government Information Quarterly*, 33(1), 174–187. <https://doi.org/10.1016/j.giq.2015.06.003>
35. Venkatesh, V., Davis, F. D. (2000). A Theoretical Extension of the Technology Acceptance Model: Four Longitudinal Field Studies. *Management Science*, 46(2), 186–204. <https://doi.org/10.1287/mnsc.46.2.186.11926>







**Devanshi Padaliya et al.,**

36. Hoque, R., Sorwar, G. (2017). Understanding factors influencing the adoption of mHealth by the elderly: An extension of the UTAUT model. *International Journal of Medical Informatics*, 101, 75–84. <https://doi.org/10.1016/j.ijmedinf.2017.02.002>
37. Rhea, C. K., Felsberg, D. T., Maher, J. P. (2018). Toward Evidence-Based Smartphone Apps to Enhance Human Health: Adoption of Behavior Change Techniques. *American Journal of Health Education*, 49(4), 210–213. <https://doi.org/10.1080/19325037.2018.1473177>

**Table1: Sample Characteristics**

	Characteristic	n	%
Age	18-44years	135	41.03
	45-59years	121	36.77
	>=60 years	73	23.33
Sex	Male	168	51.06
	Female	161	48.94
Highest Educational Qualification	Secondary	98	29.79
	Senior Secondary	114	34.65
	College Degree	117	35.56

**Table2: Scale Characteristics**

Construct	Code	No. of Items	Mean(SD)	Cronbach's Alpha
Performance Expectancy	PE	3	4.21(1.01)	.78
Effort Expectancy	EE	3	3.88 (0.96)	.81
Social Influence	SI	3	2.98(1.03)	.74
Facilitating Conditions	FC	3	3.18(0.89)	.77
Perceived Vulnerability	PV	3	3.02 (1.12)	.82
Perceived Severity	PS	3	3.56(.903)	.79
Self-Efficacy	SE	3	3.01(1.12)	.81
Behaviour Intention to use mobile application For meditation	BI	3	3.18 (.869)	.76

**Table3: Regression Analysis**

Step	Predictors	R Square	Adjusted R Square	R Square Change	Significance	β	β
1	PE	0.473	0.441**	0.457	0.001	0.381**	0.119*
	EE					0.403**	0.268**
	SI					0.074	0.068
	FC					0.263**	0.184**
2	PV	0.563	0.542**	0.09	0.000		0.191**
	PS						0.093
	SE						0.262**

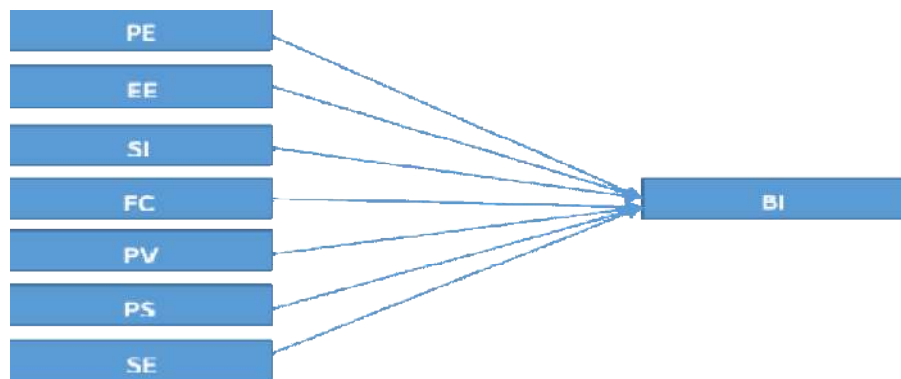




**Devanshi Padaliya et al.,**

**Table4: Results of Hypothesis Testing**

Hypothesis	Path	Result
H1	PE → BI	Supported
H2	EE → B	Supported
H3	FC → B	Supported
H4	SI → B	Not Supported
H5	PV → B	Supported
H6	PS → B	Not Supported
H7	SE → B	Supported



**Figure1: Conceptual Model**





## Oxazolidinone: A Biologically Versatile Heterocyclic Molecule

M. Kumar<sup>1</sup> and Pravin Naik<sup>2\*</sup>

<sup>1</sup>Professor and Head, Department of Pharmaceutical Chemistry, Vinayaka Mission's College of Pharmacy, Salem, Tamil Nadu, India.

<sup>2</sup>Research Scholar, Vinayaka Mission's College of Pharmacy, Salem, Tamil Nadu, India.

Received: 01 Nov 2021

Revised: 13 Dec 2021

Accepted: 08 Jan 2022

### \* Address for Correspondence

**Pravin Naik**

Research Scholar,

Vinayaka Mission's College of Pharmacy,

Salem, Tamil Nadu, India

Email: Pravin.aazcom@gmail.com



This is an Open Access Journal / article distributed under the terms of the **Creative Commons Attribution License** (CC BY-NC-ND 3.0) which permits unrestricted use, distribution, and reproduction in any medium, provided the original work is properly cited. All rights reserved.

### ABSTRACT

Oxazolidinones are essential compounds of all heterocyclic skeletal systems required for the development of new pharmaceutical drugs. Invention and detection of Oxazolidinones leads to the development of a wide range of medicinally active biological compounds. The pharmacological activity of Oxazolidinone rings can be further explored for the development of potent and highly active drug molecules when fused with other ring structures. Hetero cycles bearing nitrogen atoms constitute the core structure of a number of important physiologically active molecules and play a vital role in the metabolism of living cells. Synthesis of condensed nitrogen and oxygen heterocyclic systems containing oxazolidinone nucleus are the core centres for research and development of new drug molecules. Oxazolidinones are also important for drug development, especially in the area inhibitors of monoamine oxidase. They also have potent pharmacological effects as cytokine modulators sigma receptors, psychotropic, anti-allergy agents, antibiotics and intermediates in the synthesis of renin inhibitors,  $\beta$ -lactam and macrolide antibiotics, immune suppressants and in various other applications like ability to inhibit protein synthesis by binding to the 50S subunit and preventing the 30S complex from forming the 70S complex, resulting in inhibition of translation. In this review, we mainly aim to demonstrate some details regarding the chemistry and synthesis of oxazolidinone moiety along with their important pharmacological and medicinal properties. The present review also illustrates the information regarding the marketed preparations of oxazolidinone heterocyclic molecule which are either clinically available or which are under different phases of clinical investigation.

**Keywords:** Oxazolidinone, chemistry, synthesis, biological activity, marketed preparations.





## INTRODUCTION

Oxazolidinones are a class of oxazole's which have the carbon atom in between the nitrogen and oxygen. The carbon gets oxidized to form a ketone, hence called oxazolin-one. The carbon atoms present at the third and fifth positions are crucial for various biological activities [1]. Considering these properties, various researchers have shown a keen interest in this small heterocyclic moiety as target structure for evaluation of many pharmacological activities. Oxazolidinones are a class of compounds containing 2-oxazolidine in the structure [2]. Oxazolidinone is a five membered heterocyclic compound with potential medicinal activities. To identify the best candidate molecule exhaustive study of Structure activity relationship (SAR) is required. The "A" ring constitutes the oxazolidinone ring structure with an aryl substitution at third position called as "B" ring. The "B" ring is further extended by an amine functional group that represents the "C" ring. The presence of Oxazolidinone moiety is considered as an important pharmacophore for the research purpose. Oxazolidinone exist in different isomeric forms (Figure 1). The S-configuration of C5 side chain is essential for optimized biological activity. Difluoro substitution improves the bioavailability and potency of oxazolidinone. The N-aryl group at the third position of the oxazolidinone ring is important for the activity [2]. Structure activity relationship has been extensively studied to improve the antibacterial potency of the oxazolidinone moiety. Studies illustrate the presence of 3-(3-fluorophenyl)-oxazolidinone ring and 5-acetamidomethyl substituent for the antibacterial activity. Substitutions at the fourth position of 3-phenyl-oxazolidinone especially with 3-aryl or heteroaryl ring increases the anti-bacterial activity. Studies on synthesis and structure-activity relationship of novel oxazolidinone antibacterial molecules comprising an aza-, an oxa- and a thiabicyclo [3.1.0] hex-6-yl ring system were developed by Komine T et al., in 2008 [3]. Among the novel oxazolidinones, synthesized biaryl bicycle [3.1.0]hex-6-yl depicted potent anti-bacterial activity. The structure activity relationship studies of these novel agents suggest that presence of pyridyl ring is more preferable than the phenyl ring in C-ring subtypes. Also, structural variations of C-ring have greater impact in the antibacterial activity than that of the B-ring. The presence of cyano group at the sixth position of D -ring elucidates significant antibacterial activity [4,5].

### A PERCEPTIVE WAYLWAY TOWARDS THE SYNTHESIS ANDPHARMACOLOGICAL ACTIVITIES OF OXAZOLIDINONE MOLECULE

Oxazolidinones are an important class of mononuclear, condensed heterocyclic compounds with established medicinal properties. The literature survey reports Oxazolidinone as an essential moiety that possess various pharmacological activities and can be considered as an important target in the field of medicinal chemistry. DuPONT Asymmetric Synthesis or Herweh- Kauffmann/Speranza-Peppel Method involves cyclization of Aryl isocyanate with an epoxide in the presence of a catalyst, LiBr at high temperature. Further solubilized in refluxing xylene by tributylphosphine oxide. As depicted, 4-acetylphenyl isocyanate was used for the cyclization of DuP72 (R)-glycidol butyrate to obtain oxazolidinone butyrate ester. Methylation of 5-(R) Hydroxy methyl oxazolidinone was further carried out in presence of MsCl, NaNO<sub>3</sub>, P(OMe)<sub>3</sub> and AC<sub>2</sub>O to obtain an acetamide moiety (Scheme 1) [2].

2-oxazolidinones are obtained from various N-Boc protected alkylamines under very mild reaction conditions (Scheme 2). In 2006, Robles-Machin R et al., reported the synthesis of 2-oxazolidinone through metal catalysed intramolecular cyclization of N-Boc protected propargylamine. The reaction employed AuPPh<sub>3</sub>/AgSbF<sub>6</sub> as a catalytic system under mild reaction condition (Scheme 3) [2,6,7]. A continuous flow photochemical benzylic bromination of methyl N, N-bis (tert-butoxy carbonyl) phenylalaninate for the synthesis of 2-oxazolidinone was reported by Chen Y et al., (Scheme 4). This method can be employed for the large-scale synthesis of targeted compounds [8]. Munegumi T et al., reported the synthesis of Iminooxazolidinone via [3+2] cross coupling reactions of Aziridines with Isocyanates catalysed by Nickel (II) Iodide (Scheme 5) [2,9].

### Antibacterial activity

Oxazolidinone are well-known for its antibacterial activity, especially against gram-positive bacteria like, Methicillin- or Vancomycin-Resistant Staphylococci (MRS or VRS), and Vancomycin- or Penicillin-Resistant Enterococci (VRE or



**Kumar and Pravin Naik**

PRE). Oxazolidinone exhibits their anti-microbial activity by inhibiting the bacterial protein synthesis by acting on 50S subunit of bacterial ribosome. Thus, prevents the formation of the 70S initiation complex(Figure 2).

Linezolid (Zyvox) is the first ant-bacterial agent from the novel class of oxazolidinone approved by US FDA for the treatment of hospital acquired pneumonia by *Staphylococcus aureus* and other ailments associated with gram positive bacteria. Linezolid, a synthetic antibiotic exerts its bacteriostatic activity by inhibiting the protein synthesis through rRNA binding at Peptidyl transferase centre (PTC). It inhibits the formation of initiation complexes and reduces the length of the developed peptide chain [10]. Thus, it also decreases the rate of translation. Linezolid is administered either through Oral route or via Intravenous route. The structure activity relationship studies of Linezolid report the presence of N-aryl and 5-S configuration as an essential factor for the activity. 5-Acyl Amino methyl group and the presence of electron withdrawing group in the aryl ring has been shown to upsurge the antibacterial activity. Development of resistance is an important factor to be considered in long term antibiotic therapy. During the initial stages of Linezolid development, the drug was claimed to have no resistance. But despite its beneficial effect against a wide range of gram-positive pathogens, linezolid has been reported for the resistance in *S. aureus* strains. Long KS et al., states that, high resolution structures of Linezolid were found to bind in the deep cleft of 50S ribosomal units bounded by 23S rRNA nucleotides. Linezolid resistance is developed when there is mutation in the 23S rRNA nucleotide [11].

Other reported Linezolid resistance includes mutation in the L3 and L4 ribosomal proteins located away from the bound drug. Resistance due to acquisition of the *Cfr* gene is the only known transferable form of Linezolid resistance. Ever since the linezolid resistance has been developed, researchers are in the way of searching for new antimicrobial agents with reduced toxicity and side effects. Marketed preparations of novel oxazolidinone derivatives are depicted in the Table 1. [12,13,14].

Hou Y et al., reported the synthesis of a series of oxazolidinone derivatives with piperidinyl moiety. Compounds 9a-9m were synthesized via reductive amination of various substituted anilines or benzylamines with the key intermediated 8 (Scheme 6). Compound 9n was synthesized from compound 9h, where compound 9h was methylated with iodomethane (Scheme 7). *In-vitro* evaluation of anti-bacterial activity of compounds 9a-9n was conducted in five different bacterial strains namely, *S. aureus*, MRSA, MSSA, LREF, VRE through MIC Assay. The *in-vitro* study suggests that compound 9h was found to have 64-fold potent activity against LREF than that of Linezolid. To identify the wide range of activity against multiple strains of MDR-S aureus, compounds 9a and 9h were evaluated against clinical strains of gram-positive bacteria. From the in-vitro anti-bacterial activity against clinical isolates, compound 9h showed significantly high activity with 64-fold more potent activity against clinical isolates of LREF than Linezolid. From the study reports compound 9h exhibited significantly good activity with linezolid [15]. A recent study was reported by Jiang K et al., on the design, synthesis and biological evaluation of 3-amino-2-oxazolidinone derivatives as potent quorum sensing inhibitors of *Pseudomonas aeruginosa* PAO-1. From the ZS-12, eighteen different 3-amino-2-oxazolidinone derivatives (YXL1-YXL18) were synthesized. Among the synthesized derivatives YXL-13 compound demonstrated significant activity against antibiotic resistant *Pseudomonas aeruginosa* PAO-1 (Scheme 8) [16].

**Anti-cancer activity**

Cancer is one of the lethal causes of mortality and has affected over 8.8 million population worldwide in 2015 and has been increased by 70% during the past 20 years. Uncontrolled cell proliferation and metastasis are the characteristic features of neoplastic progression. From the past few years, cancer treatment involves radio-therapy, chemotherapy and surgery either alone or in combination. Oxazolidinones are reported to have a wide range of applications in cancer, HIV, bacterial infections, depression etc. Linezolid, the first ever FDA approved oxazolidinone molecule is reported to be studied as an alternative for vancomycin in the treatment of febrile neutropenia in cancer patients suspected with gram positive infections. Several studies are reported on the anti-neoplastic activity of oxazolidinone derivatives [17,18].



**Kumar and Pravin Naik**

Naresh A et al., reported that oxazolidinone derivatives with ethyl and acryl substitutions possess promising antitumor activity [19]. Anti-proliferative activity of several 5-(1H-1,2,3-triazolyl) methyl- and 5-acetamidomethyl-oxazolidinone derivatives were reported by Hedaya OM et al., in 2016. In the above study, eight oxazolidinone derivatives with 5-hydroxy-5-heptanoyl and 5-(1H-1,2,3-triazolyl)-methyl groups were screened for its possible anticancer activity in ER<sup>+</sup>- MCF7 eukaryotic breast cancer cell line. Among the eight derivatives, compounds PH68, PH80 and PH117 bearing triazolyl moiety were found to have promising results against breast cancer cell line with inhibition in neoplastic cell motility and cell invasion. Further investigation and validation of these molecules can be an effective approach on the future cancer therapy [20].

Recent study by Wang X et al., in 2018 reports synthesis of novel derivatives of dehydroabietic acid-oxazolidinone moieties. Anti-neoplastic activity of these compounds was screened against various human cancer cell lines namely, MGC-803, CNE-2, SK-OV-3, NCI-H460 and LO2 with respect to standard drug, Cisplatin. Among the various Dehydroabietic Acid-Oxazolidinone Hybrids, compound 4j portrayed significant anti-cancer activity with IC<sub>50</sub> value ranging from 3.82 to 17.76 μM. Further, compound 4j was known to induce apoptosis in MGC-803 cell line when subjected to Annexin-V/PI dual staining and Hoechst 33258 staining. Thus, compound 4j can be further inspected as a novel candidate molecule for the development of anti-cancer agents (Scheme 9) [21].

**Antidepressant activity**

Monoamine oxidase (MAO) is a prominent biological enzyme required for the catabolism of various chemical neurotransmitters namely, 5-HT, norepinephrine and dopamine. MAO also involves scavenging of ingested biogenic amines and averts them reaching the circulation. Oxazolidinone molecules are reported to have renowned inhibitory activity against both MAO-A and MAO-B enzymes [22]. Mai A et al., in 2002 reported the MAO inhibitory activity of various pyrrole derivatives containing 2-oxazolidinone moiety. Among the various derivative synthesized compound 1b, (R)-5-methoxymethyl-3-(1H-pyrrol-1-yl)-2-oxazolidinone showcased 116-fold greater activity than the befloxatone, a third generation MAO-I belonging to phenyl oxazolidinone class. Marketed oxazolidinone preparations like Linezolid are reported to have mild inhibitory activity against MAO-A and MAO-B enzymes [23]. A case study was reported in 2016 by Sutton J et al., where a 65-year old woman was found to have serotonin toxicity associated with concomitant use of Linezolid [24].

**1.1. Antitubercular activity:**

Tuberculosis is one of the deadliest forms of bacterial infection caused by *Mycobacterium tuberculosis*. In 2016, WHO reported about 10.4 million new cases and 1.67 million deaths related to tuberculosis. Oxazolidinones are reported to have promising action against Multi-drug resistance tuberculosis [25]. A scientific study reported in 2020 by Zhao H et al., articulates about the discovery of conformationally constrained oxazolidinones for the treatment of Multidrug resistant tuberculosis (MDR-TB). Clusters of tricyclic benzoxazinyl oxazolidinone are reported to have assuring pharmacokinetic properties with excellent antibacterial activity against gram-positive pathogens. The data obtained from their previous experimental findings, 3a,4-dihydro-1H,3H benzo[b] oxazolo [3,4- d] [1,4] oxazin-1-one core molecule was found to have good pharmacokinetic profile in comparison with Linezolid. From the stereochemistry configuration analysis, 3S, 3aS configuration was found to be optimal for the anti-tuberculosis activity.

A series of conformationally constrained molecules were developed by optimizing the stereochemistry configuration of the former core molecule. Among the developed constrained moieties, compound 19c portrayed promising antibacterial activity against *M. tuberculosis* H37R strain, drug resistant MDR-TB strain and linezolid-resistant strain. Also, compound 19c displayed better in-vivo efficacy and excellent pharmacokinetic safety profile with reduced potential for myelosuppression. Thus, compound 19c was selected as an anti-TB drug candidate and was further subjected to pre-clinical evaluation [26]. A recent study was reported by Zhuang Z et al., in 2020 in regards with a series of dual acting nitroimidazole-oxazolidinone conjugates. Researchers designed, synthesized and evaluated the antimicrobial activity of these novel conjugates. According to their reports, strong synergistic activity was observed





among nitroimidazole-oxazolidinone conjugate molecules compared to combination of Linezolid and Pretomanid (Scheme 10,11 and 12) [27].

### POTENTIAL OXAZOLIDINONE MOLECULES

Global incidence of bacterial resistance hampers the safety and efficacy of certain anti-bacterial agents which evokes an alarming threat in the treatment strategy. Thus, Medicinal chemists are in search of new drug entities with potent activity against various drug resistant bacteria. Several issues of bacterial resistance are associated with a number of Multidrug resistant gram-positive bacteria's namely, *Staphylococcus aureus* MRSA, Penicillin/Cephalosporin resistant *Staphylococcus pneumonia*, Vancomycin-resistant enterococci (VRE) etc. Apart from the former issues, considerable problems are related to Multi-drug resistant Tuberculosis (MDR-TB). A plethora of studies are still on-going in search of novel oxazolidinone molecules for the treatment of various pathogenic infections. A list of oxazolidinone molecules under different phases of clinical trials and those which are already available for the treatment are listed below [28]. The information has been collected from various online database sources like Drug bank, Wikipedia, NCBI and PubChem.

### CONCLUSION

From the past twenty years, development of drug resistance has limited the therapeutic applications of different classes of Antibiotics. In the current scenario, researchers are on the verge of discovering new drug candidates against multi-drug resistant bacterial infections. Oxazolidinones are a new class of chemical entities that have been explored for its novel mode of action against various drug resistant bacteria. Several scientific studies were reported and still most of them are in progress to identify the need to overcome the drug resistant mechanisms. Linezolid, Zyvox is the first oxazolidinone molecule approved by FDA in 2000 for the treatment of various gram-positive infections. But development of drug resistance has hampered its medicinal applications. Unexpected resistance developed by Linezolid forced many of the researchers to develop newer oxazolidinone entities. Several oxazolidinone molecules like Radezolid, Posizolid, Delpazolid etc are under clinical investigation. The chemical structure of oxazolidinone is not only explored in the area of anti-bacterial diseases but also associated with other disease conditions. In this review we mainly focused on the Structure-activity relationship studies and chemistry of novel oxazolidinone molecules. We have also shortlisted some critical points regarding the biological activity of oxazolidinone in the treatment of certain ailments. From this review, we conclude that oxazolidinone is a pharmacologically important heterocyclic molecule which can be beneficial in the treatment of various drug-resistant diseases and other associated pathogenic infections if validated properly.

### REFERENCES

1. O A Phillips, E E Udo, A A M Ali, N Al-Hassawi, Bioorg Med Chem, 2003,1, 35-41.
2. Neha Pandit, Rajeev K Singla , Birendra Shrivastava, Int J Med Chem, 2012:159285.
3. Takashi Komine, Akihiko Kojima, Yoshikazu Asahina, Tatsuhiro Saito, Hisashi Takano, Taku Shibue, Yasumichi Fukuda, J Med Chem, 2008, 20, 6558-62.
4. Adam R Renslo, Priyadarshini Jaishankar, Revathy Venkatachalam, Corinne Hackbarth, Sara Lopez, Dinesh V Patel, Mikhail F Gordeev, J Med Chem, 2005, 15, 5009-24.
5. Jeffrey B Locke, John Finn, Mark Hilgers, Gracia Morales, Shahad Rahawi, Kedar G C, Juan José Picazo, Weonbin Im, Karen Joy Shaw, Jeffrey L Stein, Antimicrob Agents Chemother, 2010, 12, 5337-43.
6. Rocío Robles-Machín, Javier Adrio, Juan Carlos Carretero, J Org Chem, 2006, 13, 5023-6.
7. Esmail Vessally, Mohammad Nikpasand, Sheida Ahmadi, Parvaneh Delir Kheirollahi Nezhad, Akram Hosseinian, Journal of the Iranian Chemical Society, 2018, 3, 617-627.
8. Yuesu Chen, Dr. Oscar de Frutos, Dr. Carlos Mateos, Dr. Juan A. Rincon, Dr. David Cantillo, ChemPhotoChem, 2018, 10, 906-912.
9. Takeshi Munegumi, Isao Azumaya, Takako Kato, Hyuma Masu, Shinichi Saito, Org Lett, 2006, 3, 379-82.





**Kumar and Pravin Naik**

10. Karen L Leach, Steven J Brickner, Mark C Noe, Paul F Miller, Ann N Y Acad Sci, 2011, 1222, 49-54.
11. Katherine S Long, Birte Vester, Antimicrob Agents Chemother, 2012, 2, 603-12.
12. Robert C Moellering, Ann Intern Med, 2003, 2, 135-42.
13. Sally Ager and Kate Gould, Infect Drug Resist. 2012; 5: 87–102.
14. Seyed Mohammad Reza Hashemian, Tayebeh Farhadi, Mojdeh Ganjparvar, Drug Des Devel Ther. 2018; 12: 1759–1767.
15. Yunlei Hou<sup>1</sup>, Yuhong Dong, Tianyu Ye, Jia Jiang, Liang Ding, Mingze Qin, Xiudong Ding, Yanfang Zhao, Bioorg Med Chem Lett, 2019, 23, 126746.
16. Kai Jiang, Xinlin Yan, Jiahao Yu, Zijian Xiao, Hao Wu, Meihua Zhao, Yuandong Yue, Xiaoping Zhou, Junhai Xiao, Feng Lin, Eur J Med Chem, 2020, 194: 112252.
17. Biagio Armentano, Rosita Curcio, Matteo Brindisi, Raffaella Mancuso, Vittoria Rago, Ida Ziccarelli, Luca Frattaruolo, Marco Fiorillo, Vincenza Dolce, Bartolo Gabriele, and Anna Rita Cappello, Biomedicines. 2020, 2, 35.
18. Júlia Furtado Campos, Michelly Cristiny Pereira, Wanessa Layssa Batista de Sena, Caio Gomes de Barros Martins, Jamerson Ferreira de Oliveira, Cezar Augusto da Cruz Amorim, Moacyr Jesus Barreto de Melo Rêgo, Marina Galdino da Rocha Pitta, Maria do Carmo Alves de Lima, Maira Galdino da Rocha Pitta, Ivan da Rocha Pitta, Pharmacol Rep, 2017, 4, 633-641.
19. Annavareddi Naresh, Maddimsetti Venkateswara Rao, Sudha Sravanti Kotapalli, Ramesh Ummanni, Batchu Venkateswara Rao, Eur J Med Chem, 2014, 80, 295-307.
20. Omar M Hedaya, Princy M Mathew, Fatima H Mohamed, Oludotun A Phillips, Yunus A Luqman, Mol Med Rep, 2016, 4, 3311-8.
21. Xiu Wang, Fu-Hua Pang, Lin Huang, Xin-Ping Yang, Xian-Li Ma, Cai-Na Jiang, Fang-Yao Li, Fu-Hou Lei, Int J Mol Sci. 2018, 10, 3116.
22. Tadeusz Z E Jones, Paul Fleming, Charles J Eyermann, Michael B Gravestock, Rona R Ramsay, Biochem Pharmacol, 2005, 3, 407-16.
23. A Mai, Marino Artico, M Esposito, R Ragno, G Sbardella, S Massa, Farmaco, 2003, 3, 231-4.
24. Jacob Sutton, Jeff Stroup, Mo Som, Proc (Bayl Univ Med Cent). 2016, 2, 214–215.
25. Zhaojing Zong, Wei Jing, Jin Shi Shu'an Wen, Tingting Zhang, Fengmin Huo, Yuanyuan Shang, Qian Liang, Hairong Huang, Yu Pang, Antimicrob Agents Chemother, 2018, 8, e00165-18.
26. Hongyi Zhao, Bin Wang Lei Fu, Gang Li, Haijia Lu, Yuke Liu, Li Sheng, Yan Li, Baoxi Zhang, Yang Lu, Chen Ma, Haihong Huang, Dongfeng Zhang, Yu Lu, J Med Chem, 2020, 17, 9316-9339.
27. Zhijun Zhuang, Dawei Wan, Jun Ding, Shijie He, Qian Zhang, Xiaomei Wang, Ying Yuan, Yu Lu, Charles Z. Ding,<sup>3</sup> Anthony Simon Lynch, Anna M. Upton, Christopher B. Cooper, William A. Denny, Zhenkun Ma, Molecules. 2020, 10, 2431.
28. De Rosa, M., Bonomo, M.G., Vassallo, A., Palma, G., Calabrone, L., Bimonte, S., Silvestris, N., Amruthraj, N.J., Sinicropi, M.S., Salzano, G. and Arra, C., 2018, *PharmacologyOnline*, 2, 134-148.

**Table 1 : Tabular column illustrating the potential marketed preparations of oxazolidinone molecules and also molecules under investigation. The table explains the target of action and indication of various marketed formulations along with their clinical status.**

Sr.n o.	Drug and brand name	Target of action	Approval year	Indication
1	Linezolid (Zyvox)	Inhibits protein synthesis by binding to domain V of 23S rRNA of 50S subunit	2000	Against gram positive bacterial infections
2	Tedizolid	Binds to the acceptor site of	2014	Used for the treatment of

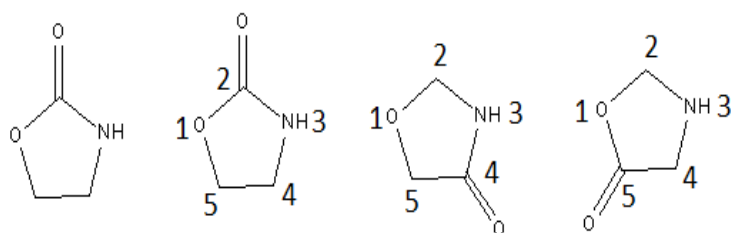






**Kumar and Pravin Naik**

	phosphate (Sivextro)	PTC at 50S subunit and inhibits bacterial protein synthesis		MRSA skin infections and Acute bacterial infections of the skin and skin structure (ABSSSI)
3	Ranbezolid	Inhibits the bacterial ribosomal protein synthesis by binding to 23S rRNA of the 50S ribosomal unit	Under Preclinical investigation	Effective against gram-positive infections
4	Sutezolid	Binds to 23S ribosome blocks microbial protein synthesis	Undergoing Phase II Clinical trial	Against Drug Susceptible-Tuberculosis (DS-TB) and Multi-drug resistance Tuberculosis (MDR-TB)
5	Radezolid	Inhibits bacterial protein synthesis	Completed Phase II clinical trial	Against gram positive bacterial infections
6	Posizolid (AZ5847)	Bacterial protein synthesis inhibition by binding to sites of bacterial ribosome. It prevents the formation of functional 70S initiation complex	Completed Phase I trials, now under Phase 2a clinical trial	Effective against Multi-resistant strain and gram-positive bacterial infections
7	Delpazolid	Blocks the acceptor site of bacterial ribosome and thus interrupts the peptide chain elongation. Misreads the genetic code and prevents the attachment of oligosaccharide side chains to glycoproteins	Under Phase II clinical trial	Used against MDR pathogenic infections and gram-positive infections
8	Contezolid (MRX-1)	Inhibits the bacterial protein synthesis by binding to the ribosomal RNA	Completed Phase II clinical trial	Effective against skin and soft tissue infections



**Figure 1: The above figure depicts the possible isoforms of Oxazolidinone**





Kumar and Pravin Naik

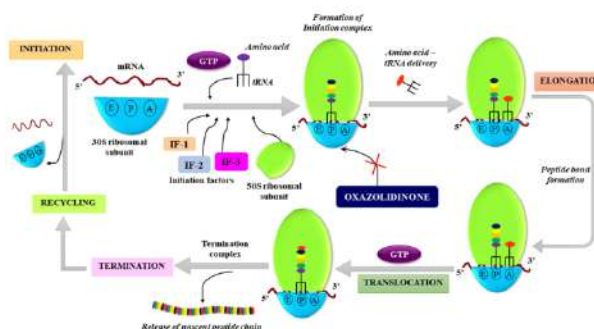
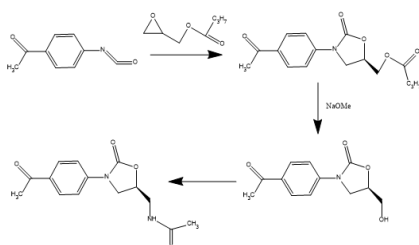
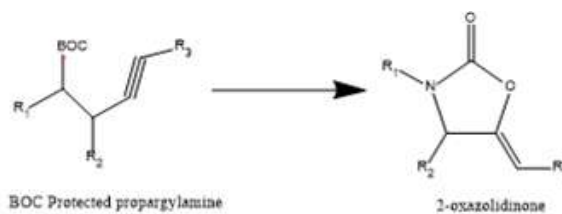


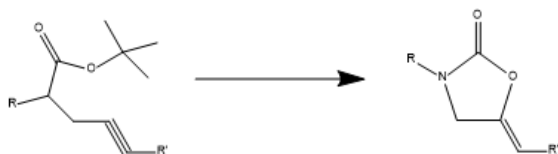
Figure 2: Diagrammatic illustration of Bacterial protein synthesis. The process mainly involves Initiation, Elongation, Translocation and Termination. Oxazolidinone molecule imparts anti-bacterial activity by inhibiting the formation of Initiation complex. Inhibition of Initiation complex further hinders the translocation and termination steps that leads to reduced length of nascent peptide chain



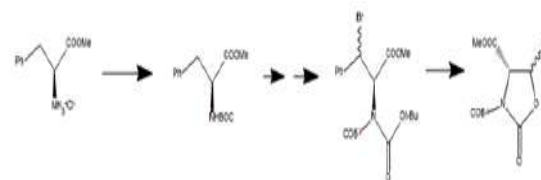
Scheme 1: Synthesis of Oxazolidinone molecule through DuPont synthesis



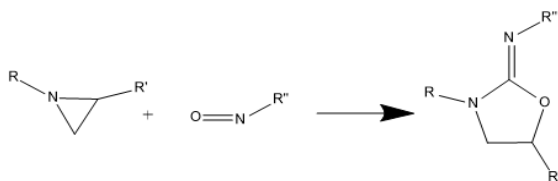
Scheme 2: Oxazolidinone synthesis through Intramolecular cyclization of N-Boc protected propargylamine



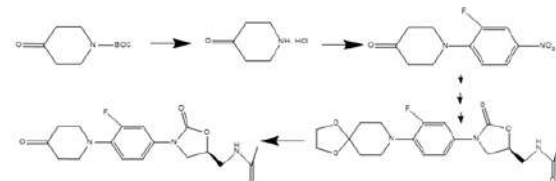
Scheme 3: Synthesis of Oxazolidinones from various N-Boc protected alkylamines under mild reactions in the presence of Cationic Au (I) complex



Scheme 4: Synthesis of Oxazolidinone through photochemical benzylic bromination of methyl N, N-bis (tert-butoxy carbonyl) phenylalaninate

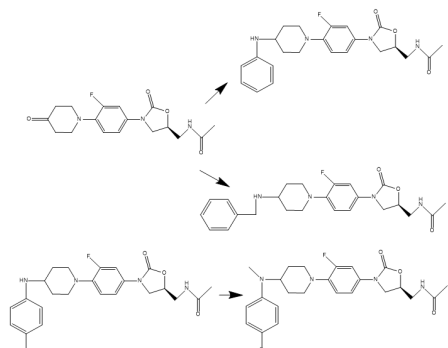


Scheme 5: Synthesis of Oxazolidinone through Nickel catalysed cycloaddition of Aziridines

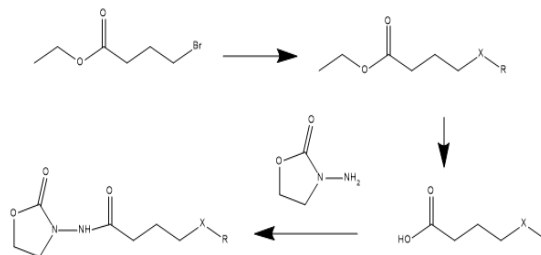


Scheme 6: Synthetic route of Intermediate 8, a key molecule used in the production of compounds 9a-9m by Hou Y et al., 2019

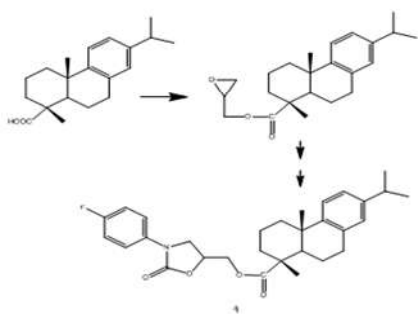




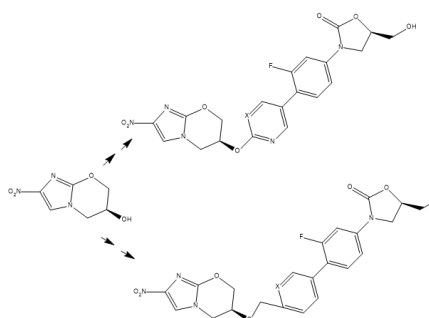
Scheme 7: Pictorial representation of synthesis of compounds 9a-9n, novel oxazolidinones derivatives proposed by Hou Y et al., 2019



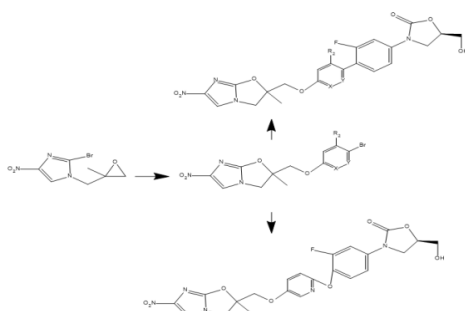
Scheme 8: Synthesis of target compound, YXL-13. The 'X' in the final structure is 'O' and 'R' is brominated benzene ring with n=1.



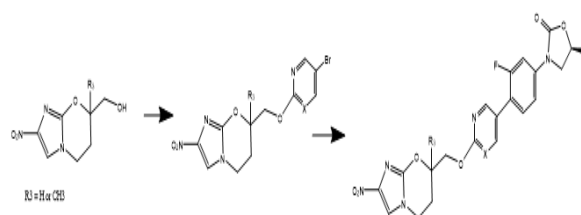
Scheme 9: Synthetic pathway of compound 4j as proposed by Wang et al., 2018



Scheme 10: Diagrammatic representation of synthetic route of compounds 8a, 8b, 11a and 11b as reported by Zhuang Z et al., 2020



Scheme 11: Diagrammatic representation of synthetic route of compounds 14a-d and compound 16 as reported by Zhuang Z et al., 2020



Scheme 12: Diagrammatic representation of synthetic route of compounds 19a, 19b and 19c as reported by Zhuang Z et al., 2020





## A Paradigm for Predicting the Future Trends of Pandemic due to Corona Virus after Mass Immunization through Vaccination

Sandip Roy<sup>1</sup>, Priyanka Bhattacharya<sup>2</sup>, Indranil Sarkar<sup>3</sup>, Haraprasad Mondal<sup>4\*</sup> and Rajesh Bose<sup>1</sup>

<sup>1</sup>Associate Professor, Department of Computational Science, Brainware University, Kolkata- 700124, India.

<sup>2</sup>Assistant Professor, Department of Computer Application, Nopany Institute of Management Studies, Kolkata - 700006, India.

<sup>3</sup>Assistant Professor, Department of Computational Science, Brainware University, Kolkata- 700124, India.

<sup>4</sup>Assistant Professor, Electronics and Communication Engineering, Dibrugarh University, Dibrugarh, Assam- 786004, India.

Received: 16 Dec 2021

Revised: 06 Jan 2022

Accepted: 21 Jan 2022

### \*Address for Correspondence

#### Haraprasad Mondal

Assistant Professor,  
Electronics and Communication Engineering,  
Dibrugarh University,  
Dibrugarh, Assam, India.  
Email: mandal.haraprasad@gmail.com



This is an Open Access Journal / article distributed under the terms of the **Creative Commons Attribution License** (CC BY-NC-ND 3.0) which permits unrestricted use, distribution, and reproduction in any medium, provided the original work is properly cited. All rights reserved.

### ABSTRACT

Due to the outbreak of corona virus, our lifestyle has been changed exceptionally. The pandemic has affected various sectors like education, finance, tourism, travel, etc. throughout the world. The whole population should be aware of the different symptoms of corona virus and maintains their lifestyle. Several research works are continued for forecasting the endpoint of the pandemic and the extension of lockdown. The whole population entire world can take different preventive measurements from the outcomes of the research works and protect them from this pandemic. But the researchers have not worked on the transmission rate of corona virus disease globally. In this approach we have shown the originality of our work. The authors have collected data from various sources on corona virus disease of various affected countries throughout the world. Authors have started experiment on that data and eventually have prepared a mathematical model to project on the probable future trends of the transmission rate of the corona virus disease for these countries. Different healthcare enterprises and federal agencies can accept this forecasted data and can take preventive measurements to protect their nation from the pandemic.

**Keywords:** Vaccination, COVID-19, Partial lockdown, Herd Immunity, Corona virus, ARIMA model, Static Autoregressive, Python 3.9.



**Sandip Roy et al.,**

## INTRODUCTION

"NOVEL" corona virus disease is the most focussed topic since December, 2019 in worldwide. Wuhan city of China has been affected first by this pandemic disease. A number of countries and territories have been severely infected due to the worldwide outbreak of the disease till now [1]. The normal life around the whole world has been severely damaged due to this communicable disease, because of absence of proper vaccines and drugs. The research paper[2] has presented a paradigm for fifteen countries for getting an idea about future projections of this pandemic. In this research paper it has been discussed about a predictive paradigm for probable future projections. In their report they have collected data about total COVID-19 cases, total death cases, total survival cases for affected countries periodically and applied SIR model to obtain probable future projections. A time dependent discrete SIR model has been presented to forecast the tendency of the disease transmission rate. In their research work, the change in basic reproduction number has been shown. This change is referred to as the sign of the future trend of the transmission rate. So, the spreading of corona virus can be controlled globally by taking decisions of strict and partial lockdown as well as the proper maintenance of social distancing. Further, as per the report based on April 10, 2021, the total identified cases in USA are highest, Brazil holds the second position and India holds the third position. In the middle of March 2021, the second phase of 'novel' corona virus has started, and on April 09,2021 the maximum number of cases (144,829) has been identified in India on April 09,2021[3].According to the report of World Health Organization (WHO) total 229,858,719 verified cases and 4,713,543 deaths have been recorded globally till date. WHO has collected reports from government of 222 countries and territories about 229.8 million corona virus cases and 4.71 million deaths as of 23<sup>rd</sup> September 2021.Moreover, according to the report generated by WHO on 22/09/2021 the total of ~5.88 crore doses of vaccine have been recorded. As per Present statistics USA, Europe, South East Asia, Africa and Western Pacific have been suffering till now [2].In India total 3,30,96,718 active cases and 4,41,411 death cases have been reported till date[3]. The research paper[4] has proposed a forecasting model to analyze the trends of the pandemic disease. The government of India has forced several states to maintain complete lockdown to reduce the severe outbreak of corona virus. Some states have chosen the decision for partial lockdown.

A number of research articles have been published on various characteristics of the spreading of the pandemic disease, forecasting of end point of corona virus in different countries and the size of the virus at the endpoint[5-8]. A detail survey of the prediction models for the corona virus pandemic disease has been discussed in the research paper[9]. Some mathematical models for the deadlier corona virus disease for India has been discussed in the research paper [10]. The people throughout the world have been affected by Great Influenza virus during 1918-1920. The fatality rate and economic recession during that period has been calculated in the article [11].The outcomes of different travel restrictions have been discussed in several research papers[12-14].The travel limitation to and from Republic of China (90%) have affected the route of the pandemic. Early detection of the disease and home segregation are more fruitful than travel restrictions. Systematic Review and Meta-Analysis Protocol have been discussed in for proper identification of benefits of various precautionary measurements taken for travelling. Both international and domestic travel measures have been explained. Some plans of actions have been suggested in the research article for controlling the severe outbreak of corona virus [15]. The time series SIR model which was used to forecast the rate of transmission for measles epidemic has been discussed in article [16]. This model [16] is also important for forecasting the rate of transmission for corona disease. In the article [17] a time dependent SIR model has been analysed for unrevealed affected persons. In research papers [18] the situation of pandemic in China (due to corona virus) have been analysed for 2020.This pandemic situation in 2020 for different countries like Germany [19],Portugal [20], United States [21],Italy [22],and Brazil [23] have also been depicted in various research works. Some mathematical paradigms have been proposed for taking actual decisions to reduce the number of new affected cases have been done by segregating the people from the affected population [24]. This calculation has been used to forecast the severity of corona virus throughout the world. As of 5<sup>th</sup> September, 2021 the world-wide fatality rate is 2% [25].Therefore, at present situation fatality rate is not so alarming.

Chen *et al* [26] have suggested about a time related dynamic system to explain the severity of corona virus disease in China. They have used numerical simulation and have suggested that the transmission rate of the disease should be





**Sandip Roy et al.,**

highly controlled with the decision of segregation from the affected people by the government. Baiet *al.* [27] have reviewed numerical analysis to track asymptomatic transmission rate and to predict the future trend. Anastas sopoulou *et al.* have provided an approximate fatality rate and survival ratio. The SIDR model has provided the approximate rate of basic reproduction number ( $R_0$ ) as well as daily basis mortality rates along with recovery rates. The researchers have tried to forecast the growth of the disease, three weeks ahead by using SIDR model [28]. The work [29] published in 2020 has discussed about the decision for quarantine and the consequences of loneliness. A model has been presented by YAFIA, where different circumstances due to social distancing and segregation effect have been discussed and this model has also been applied to Moroccans [30]. In the research paper [31], a propagation patterns of epidemic diseases such as COVID-19 has been studied such from a mathematical modelling perspective. However, different popular time series prediction models along with important classes like stochastic, neural network and support vector machines with their main characteristics have been clearly explained in the book [32]. The paper [33] has used time series modelling (ARIMA and cubic smoothing spline) to predict confirmed cases, death cases and recovery rates of COVID-19. The decision of social isolation in terms of lockdown has been discussed in the research paper [34]. A large population throughout the world has worked for office from their home to maintain social isolation for preventing themselves from deadlier corona virus. The paper [35] has depicted a clear picture to maintain the security of entire cloud-based information system. A mathematical procedure which is based on machine learning technique has been analysed to reduce the effect of deadlier pandemic disease [36].

However, the main goal of our proposed research work is to obtain more accurate forecasted result for forthcoming year using ARIMA model. In this paper data has been collected for confirmed COVID-19 cases, death cases and vaccinated cases for United States of America, India, Brazil and Russia from January, 2020 to August, 2021 and has been calculated forecasted values for upcoming one year using historical data. The authors of this paper have analysed the predicted values for newly infected cases and fatality rates due to corona virus disease after vaccination and have calculated the forecasted error which is basically the difference between original value and the forecasted value. No existing research works on prediction of tendency of the virus transmission have been observed worldwide. Our proposed research work proves its originality based on this. The outline of the research work can be depicted as follows:

- ARIMA (AR: Auto regression, I: Integrated, MA: Moving Average) has been opted to forecast time series data and calculate predicted and expected value for COVID-19 cases for the forthcoming year.
- A specific ARIMA model has been used by a standard notation ARIMA (x, y, z) where the parameters have been replaced by integers. The number of lag observations is denoted by x, the raw observations variation time is designated by y and moving average window size is symbolized by z.

The authors have arranged the rest portion of the paper as follows. The detail analysis of collected data for time series forecasting regarding corona virus pandemic for the period of August, 2021 to August 2022 has been done in the section two. The proposed methodology for forecasting of confirmed corona virus affected case, death case and vaccinated case has been discussed in section three. Section four depicts the empirical results with comparisons and evaluates the performance of the research work. Different suggested policies for controlling the pandemic disease have been discusses in section five. The conclusion and future orientations have been discussed in the last section.

### Data Analysis

Predictions on different factors like newly infected cases, newly death cases due to spreading of vaccination would help government to take right decisions for future. Here, in this section, few data for USA, India, Brazil and Russia have been analysed for the period of January, 2020 to August, 2021. In figure-1 the authors have analysed total COVID-19 positive cases for USA, India, Russia and Brazil during first and second wave of pandemic. For USA it has been noticed that the total corona virus affected cases has been decreased in the month of July to October, 2020 but from November, 2020 onwards the number of total infected people has been increased. It has also been noticed that the infection rate was decreasing gradually during November, 2020 to March, 2021 in India. But from April, 2021 the





### Sandip Roy et al.,

rate of infection in India is still increasing. Moreover, from figure 1 it is clear that Brazil is not as much affected as USA or India but still the number of infected people is increasing. Comparatively Russia is less affected country.

Figure-2 depicts a comparative study on total affected people per one million of population during different phases of pandemic. It has been observed that the chance of spreading the virus is more in densely populated countries. The rate of infection is highest for USA. Brazil holds the second position. Though India is severely corona virus affected country, but the number of infections per 1 million of people is less than USA and Brazil. From the figure it has been seen that the rate of infection per 1 million of population is comparatively less for Russia. From 22<sup>nd</sup> January, 2020 to 19<sup>th</sup> August, 2021, newly infected cases for the above-mentioned countries per day have been documented and have plotted graphically in figure-3. The highest number of newly infected cases in USA has been observed during the month of October, 2020 to February, 2021 from day-to-day observations depicted in figure 3. During the month of April, 2021 to June, 2021 the daily infection rate is highest for India. On the other hand, rate of infection is not as higher as in Brazil. Comparatively Russia is less infected country. Now, the daily fatality rate due to corona virus disease is about 0.005%. The day wise survival rate of COVID 19 is approximately 99.9%. Table 2 shows the survival rate and fatality rate before and after vaccination for most affected countries.

### Proposed Methodology

Hethcote has worked on different mathematical models in his research work [38] and have used it in certain diseases with respect to the inclination of spreading of viruses. In research paper [39] the authors have introduced ARIMA as Time Series Forecasting Model.

### ARIMA Model for Forecasting of Corona virus Disease

The authors have used ARIMA model as a class of statistical models, which is used to analyse and forecast time series data for positive active cases and fatality cases due to corona virus diseases. ARIMA models describe the circumstances that evolve through time and forecast future values. This model is based on following three sub-models:

- AR (Auto regression): This model observes the observation for present day and the observation for previous time period should be noted. This model is based on the relationship between these two parameters.
- I (Integration): This model subtracts an observation from the observation of previous time step uses to make static time series.
- MA (Moving Average): This model uses the interdependency between an observation and a residual error from a moving average model applied to lag observations.

A specific ARIMA model has been used by a standard notation ARIMA (x, y, z) where the parameters have been substituted with integer values. The ARIMA forecasting equation for a static time series is a linear equation. Delays of different dependent variable and residual errors are mentioned in the ARIMA forecasting equation.

We have defined the parameters of the ARIMA model in following way:

'x' denotes the number of lag phases.

'y' denotes the measure of differencing.

'z' denotes the size of the moving mean or rolling mean.

The construction of the forecasting equation depicted in the following way:

The ARIMA forecasting equation can be stated as

Forecasted value of H depends on a constant and a weighted sum of one or more recent values of H and a weighted sum of one or more recent values of the errors.

Assume that h denotes they<sup>th</sup> difference of H.

Case 1:

When, y=0, then  $h_t = H_t$

Case 2:

When, y=1, then  $h_t = H_t - H_{t-1}$





**Sandip Roy et al.,**

Case 3:

When  $y=2$ :  $h_t = (H_t - H_{t-1}) - (H_{t-1} - H_{t-2}) = H_t - 2H_{t-1} + H_{t-2}$

The authors have depicted the general equation of ARIMA model as

$$\hat{h}_t = \alpha + \beta_1 h_{t-1} + \dots + \beta_x h_{t-x} - \gamma_1 \epsilon_{t-1} - \dots - \gamma_z \epsilon_{t-z}$$

From the above equation  $\gamma$ 's are defined as moving average or moving mean parameter. So, negative sign has been used. A series of random errors which is also referred to as residuals has been defined as  $\epsilon$  in the general equation of ARIMA model. Auto regressive parameters are defined as  $\beta$ .

## EXPERIMENTAL RESULTS AND DISCUSSIONS

This section describes different views of our proposed model for analysing the effect of corona virus vaccination on the transmission rate of the disease and discusses about the originality of the work and assessment of the performance.

### Preparation and Validation of Dataset

The authors have collected dataset from Worldometer [40] and based on that dataset they have researched for forecasting of corona virus infection after vaccination throughout the world. The dataset is maintained by an International Group of Researchers. The main goal of this research work is to prepare world statistics available in an appropriate format. American Library Association has acknowledged the world statistics as the best free reference website. This statistic has been reviewed by several researchers for continuing their research on corona virus disease. The authors have used numbers of daily new corona virus infected cases, daily rate of survival, daily total infected cases, and daily fatality rates for analysis and forecasting of transmission rate of the disease and impact of vaccination on it.

### Vaccination Effect Analysis on Disease Spreading

The transmission of the corona virus has been affected by many factors. A dynamic transmission model has been established based on these different estimated factors. This model can make the whole population throughout the world aware of the outbreak of this pandemic so that they can maintain their lifestyle accordingly by receiving information about fatality rate, incidence rate. The expansion of the outbreak is analysed by ARIMA model (time dependent) and are represented in figure-4 and figure-5. Result of mathematical modelling on date-wise actual new infected corona virus positive cases versus predicted new infected corona virus positive cases using ARIMA model is shown in figure-4. From the figure, it has been observed that our forecasted results are almost near to the real trend of transmission. In this paper figure-4 and figure-5 show only the graphical representation of our results because it's not possible to offer the overall calculation of basic reproduction number, number of newly infected case and number of new fatality rate. Vaccination program has been started in these most affected countries from January, 2021. From figure 4 and figure 5 the predicted values of new infected cases and fatality rates are observed and it is still in decreasing nature after September, 2021. Figure 6 also shows the predicted reproduction rate for USA, Russia, India and Brazil which have been considered as most affected countries in world wide till August, 2021. Though some deviation exists in the graphs but still the patterns of the graphs follow actual one.

Though for India the reproduction rate has increased around April, 2021 after starting of the immunization program through vaccination, but after June, 2021 the rate has been decreased. We have also observed from the figure 4 to 6 that immunization program through vaccination is obviously effective for other countries like USA, Brazil and Russia. Moreover, figure 6 is concerned about only the predicted value of transmission rate. From the collected data it has been observed that during the first phase of vaccination program the number of corona virus infected people has been raised that means the second wave of corona virus has attacked the population but after June, 2021 the basic reproduction rate has been reduced ( $R_0 < 1$ ). The observation from figure 6 we can conclude that the decision of enhancing immunization is obviously effective. More people should be vaccinated to decrease the infected population and after that people can be safe. Authors have run auto regression calculations by using free machine





**Sandip Roy et al.,**

learning library of Python 3, Scikit-learn, matplotlib, and stats models. The transmission rate of the virus can't be negative; hence, it is considered as 0 when it is 0. The data from January,2020 to August,2021 has been considered for future prediction of end date of pandemic, death rate and new death cases due to this pandemic. The basic reproduction number depends on the number of new corona virus infected people and an infected person before his/her recovery or death. If the basic reproduction number is greater than 1, then the probability of spreading the corona virus disease is maximum, exponential growth is observed and then a certain percentage of whole population has been affected.

Figure 4a depicts the comparison between actual and predicted new infected cases in USA. The prediction shows that from November,2021 to January,2022 the number of new affected cases would be maximum. After February, 2022 the rate of new affected cases can be reduced. Again, it is increasing after July,2022. The comparison between actual and forecasted new infected cases has been depicted for India in figure 4b. The prediction shows the highest rate of new infected cases from January,2022 to March,2022. From April,2022 the rate of new infected cases is decreasing. The prediction for Russia has also been observed as depicted in figure 4c. In this figure actual and predicted values for newly infected cases have been observed. The prediction shows that rate would be high during the month of October,2021 to January,2022. After that the rate would be decreased slowly, but from June 2022 it is again rising. The authors have observed the actual and predicted values for newly infected cases for Brazil in figure 4d. The prediction shows fluctuating rate of new infected. From time to time, it would be increased and will be highest during the month of July,2022. Figure 5a depicts the comparison between actual and predicted new death cases in USA. The prediction shows that the predicted death rate is gradually decreased in nature. Only during the month of January and February,2022 the rate of new death cases would be high gain, it is reduced. The comparisons between actual and predicted new infected cases have been depicted for India in figure 5b. The prediction shows that the highest rate of newly death cases from April,2022 to June,2022. But from September,2021 to March, 2022, it is decreasing in nature. The prediction of new death cases for Russia has also been observed in figure 5c. In this figure actual and predicted values for new death cases have been observed. The prediction shows that rate is high during the month of October,2021 to January,2022. After that the rate would be decreased slowly, but from June 2022 it would be again rising. The authors have observed that the actual and predicted values for new death cases for Brazil in figure 5d. The prediction shows that the death rate is minimum up-to January,2022. From time to time it is increased and would be highest during the month of April,2022.

Figure 6 depicts the predicted reproduction rate for USA, India, Russia and Brazil for upcoming one year. It is clearly observed that the predicted reproduction rate is too low for USA and it is almost 0. During March, 2022 and April,2022, it would be slightly increased to approximately 0.2 and in July,2022 it would be increased to 0.6. For Russia and Brazil, the predicted reproduction rate is also less than 1. Moreover, only for India the reproduction rate is high from February, 2022 to April,2022 and it will be almost 1. The forecasting of new corona virus affected population and fatality rate has been depicted from all experimental results. At the time of comparison of forecasted data with the original one minimum deviation has been observed. But we can follow the nature of transmission rate of the corona virus disease and characteristics as regards for four countries worldwide. The important effect of immunization program through vaccination as well as proper maintenance of social distancing can reduce the outbreak of corona virus. The examples are taken from January 22, 2020 to August,2021. The data consists of almost 550 instances and four features. These features provide information about the number of daily new affected cases, number of fatality rate, number of total affected cases and reproduction rate. This information has been treated as parameters for analysis. Our proposed mathematical model shows its robustness. Authors have calculated root mean square error between actual and predicted values. The root mean square error is dependent on total population of country.

### **Suggested Policy taken by Government Authority**

The main goal of the article is to prepare a paradigm for analysing immunization program through vaccination. We have observed from various research works the basic reproduction number ( $R_0$ ) for Brazil, India, Russia, and USA have been varied due to strict and partial lockdown. However, in our mathematical model we have observed that





**Sandip Roy et al.,**

during the first phase of vaccination program the number of new corona virus affected people increases periodically as shown in figure-1 to figure 3 but from figure-4 to 6 degradation in the transmission rate of the corona virus disease for India, USA, Brazil and Russia has been observed from the month of august, 2021 after maintaining lockdown and continuation of vaccination program[41].

### **Partial Lockdown**

It may be stated that strict lockdown is effective measure to protect the people worldwide from corona virus but economic slowdown due to lockdown throughout the world is also a concerned factor. A huge number of people have lost their job, education system has been highly affected. Many countries throughout the world have started online education system for the school level, college level and also for University level. But in the third world countries like India a number of people is under below poverty line, the children of that families go to mid-day-meal school not for only the education purpose but for also having their meal regularly. It is very difficult for them to afford the cost for online education. A number of parents are not technically sound, their children who are the students of primary classes are not able to attend online classes and other activities. Other industries like travel has also been affected due to strict lockdown. So government can take a decision for partial lockdown as a preventive measurement. Government of few countries like India has already decided to open few offices with restricted number of employees. But if Government takes the decision to open schools with restricted number of children to avoid social distancing then education system would not be affected too much as well as the reproduction rate of corona virus and death rate due to corona virus can be decreased gradually. So we can conclude that partial lockdown is a preventive measurement of spreading the corona virus and it should be continued.

### **Immunization Program Through Vaccination**

Vaccination program has been started throughout the world from January,2021. The infection rate has been increased gradually during the first phase of vaccination. But from figure 4 and 5 it has been observed that the predicted rate of infection in 2022 will be gradually decreased and it would be less than that of the year 2021. So, besides partial lockdown, mass immunization program through vaccination is another preventive measurement to protect people from corona virus. Vaccination has not been started for the age below 18 years. So, implementation of a plan regarding continuous monitoring of vaccination program to immunize children, teenagers through vaccine before opening the school in offline mode is expected from government authorities. Door-to-door vaccination procedure may also be taken as a preventive measurement and it would be very helpful to monitor the vaccination program continuously.

### **Herd Immunity**

Necessary preventive measurements should be taken by government to enhance the resistance to the corona virus disease of a large percentage of a community so that the entire community becomes protected. The decision of partial lockdown may be withdrawn after proper immunization of entire community. A certain percentage of people of a particular society need to achieve herd immunity. The survived people from corona virus disease do not require immunity as because of they have been survived from the disease. If the crowd is affected by the disease again then the severity may be very low. Around 32 million people in India and 33 million people in USA have been affected by corona virus up to January,2021 and those people have survived from the disease. So, we can say that the disease is not as much severe for them as well as the resistance to the disease has been developed for this large percentage of people. These people are not responsible for transmission of the disease to the people of an entire society who have not developed their resistance power. Hence, people who have not developed immunization in their body are also protected from corona virus disease. In various research papers we have observed the average reproduction number( $R_0$ ) for India is approximately 1.2[42, 43]. As per the estimation from experts 70% of entire population needs to be vaccinated and sometimes 90% people should be vaccinated [44].

## **CONCLUSION**

The impact of vaccination program has been discussed in this paper based on the ARIMA model on severe out breaking of corona virus disease. We have analysed three stages of out breaking of corona virus in different



**Sandip Roy et al.,**

countries: the infection rate increases drastically from first stage to third stage of out breaking of the disease. Taking different decisions on strict/partial lockdown the infection rate has been decreased gradually but it has a major impact on economy throughout the world. So, we can conclude that mass immunization through COVID-19 vaccine is the long-term remedy to protect people from getting infected from the virus. The challenges of predicting parameters like rate of transmission, new death cases which include lack of proper data. To get improvement in the experimental result the limitations of this paper can be used in future and this layout will show our proposed mathematical model is compatible with concerned field of analysis. Depending on various external factors like decisions made by government of the affected countries, different actions taken by the nation of a country the forecasting may be varied in future. So based on different situations in future the forecasted data of today may not be true. However, the prediction can be changed based on some external factors such as government decisions and human actions, so we can't train the data as of today to be true for a different situation in future. Proposed ARIMA model is more beneficial than the traditional ARIMA model. The proposed mathematical model is also very useful to handle and adopt the current situation.

## ACKNOWLEDGMENTS

The authors sincerely acknowledge to the Dibrugarh University, Dibrugarh, India and Brainware University, Kolkata, India for providing infrastructure and support of other related facilities for successfully doing the research. Moreover, authors would like to state that there is no funding for this work.

## REFERENCES

1. Ghosh A, Roy S, Mondal H, Biswas S, Bose, R. Mathematical modelling for decision making of lockdown during COVID-19. *Applied Intelligence* 2021; 1–17. Advance online publication. <https://doi.org/10.1007/s10489-021-02463-7>
2. "World Health Organization", [Online]. Available:<https://www.who.int/emergencies/diseases/novel-coronavirus-2019> (May 2020).
3. Ghosh A, Nundy S, Mallick TK. How India is dealing with COVID-19 pandemic. *Sensors International* 2020; 1: 100021.
4. Khajanchi S, Sarkar K, Mondal J. Dynamics of the COVID-19 pandemic in India. *arXiv preprint arXiv:2005.2020.06286*.
5. Chen B, Liang H, Yuan X, Hu Y, Xu M, Zhao, Y, et al. Roles of meteorological conditions in COVID-19 transmission on a worldwide scale. *MedRxiv* (2020).
6. Sun P, Lu X, Xu C, Sun W, Pan B. Understanding of COVID-19 based on current evidence. *Journal of medical virology* 2020; 92(6): 548–551. <https://doi.org/10.1002/jmv.25722>.
7. Brüssow H. The Novel Corona virus - A Snapshot of Current Knowledge. *Microbial biotechnology* 2020; 13(3):607–612. <https://doi.org/10.1111/1751-7915.13557>.
8. Luo J. When will COVID-19 end? Data-driven prediction. *Singapore University of Technology and Design* (<http://www.sutd.edu.sg>)(2020).
9. Batista M. Estimation of the final size of the COVID-19 epidemic, (2020).
10. Shinde GR, Kalamkar AB, Mahalle PN, Dey N, Chaki J, Hassanien A E. Forecasting Models for Corona virus Disease (COVID-19): A Survey of the State-of-the-Art. *SN computer science* 2020; 1(4): 197. <https://doi.org/10.1007/s42979-020-00209-9>.
11. Bholá J, Venkateswaran VR, Koul M. Corona epidemic in Indian context: predictive mathematical modelling. *MedRxiv* (2020).
12. Barro R J, Ursúa J F, Weng J. The corona virus and the great influenza pandemic: Lessons from the "spanish flu" for the corona virus's potential effects on mortality and economic activity (No. w26866). National Bureau of Economic Research (2020).
13. Grépin KA, Ho TL, Liu Z, Marion S, Piper J, Worsnop CZ, et al. Evidence of the effectiveness of travel-related measures during the early phase of the COVID-19 pandemic: a rapid systematic review. *BMJ global health* 2021; 6(3): e004537.





**Sandip Roy et al.,**

14. Chinazzi M, Davis JT, Ajelli M, Gioannini C, Litvinova M, Merler S, et al. The effect of travel restrictions on the spread of the 2019 novel corona virus (COVID-19) outbreak. *Science (New York, N.Y.)* 2020; 368(6489): 395–400. <https://doi.org/10.1126/science.aba9757>.
15. Lai S, Bogoch I, Ruktanonchai N, Watts A, Lu X, Yang W, et al. Assessing spread risk of Wuhan novel corona virus within and beyond China, January-April 2020: a travel network-based modelling study. *medRxiv: the preprint server for health sciences*, 2020.02.04.20020479. <https://doi.org/10.1101/2020.02.04.20020479>
16. Arti MK, Bhatnagar K. Modelling and predictions for COVID 19 spread in India. Research Gate, DOI: DOI, 10. (2020)
17. Bjørnstad ON, Finkenstädt BF, Grenfell BT. Dynamics of measles epidemics: estimating scaling of transmission rates using a time series SIR model. *Ecological monographs* 2002; 72(2): 169-184.
18. Chen YC, Lu PE, Chang CS, Liu TH. A time-dependent SIR model for COVID-19 with undetectable infected persons. *IEEE Transactions on Network Science and Engineering* 2020; 7(4): 3279-3294.
19. Li Q, Feng W, Quan YH. Trend and forecasting of the COVID-19 outbreak in China. *The Journal of infection* 2020; 80(4):469–496. <https://doi.org/10.1016/j.jinf.2020.02.014>
20. Rothe C, Schunk M, Sothmann P, Bretzel G, Froeschl G, Wallrauch C, et al. Transmission of 2019-nCoV Infection from an Asymptomatic Contact in Germany. *The New England journal of medicine* 2020; 382(10): 970–971. <https://doi.org/10.1056/NEJMc2001468>
21. Teles P. Predicting the evolution of SARS-Covid-2 in Portugal using an adapted SIR Model previously used in South Korea for the MERS outbreak. *arXiv preprint arXiv:2003.10047*. (2020)
22. Liu P, Beeler P, Chakrabarty RK. COVID-19 progression timeline and effectiveness of response-to-spread interventions across the United States. *medRxiv*. (2020)
23. Wangping J, Ke H, Yang S, Wenzhe C, Shengshu W, Shanshan Y, et al. Extended SIR Prediction of the Epidemics Trend of COVID-19 in Italy and Compared with Hunan, China. *Frontiers in medicine* 2020; 7: 169. <https://doi.org/10.3389/fmed.2020.00169>.
24. Cintra H, Fontinele FN. Estimative of real number of infections by COVID-19 in Brazil and possible scenarios. *Infectious Disease Modelling* 2020, 5: 720–736. <https://doi.org/10.1016/j.idm.2020.09.004>
25. Adekola HA, Adekunle IA, Egberongbe HO, Onitilo SA, Abdullahi I N. Mathematical modelling for infectious viral disease: The COVID-19 perspective. *Journal of public affairs* 2020; e2306. Advance online publication. <https://doi.org/10.1002/pa.2306>
26. [https://covid19.who.int/?gclid=EA1aIQobChMizMeUx9fv8gIVxYJLBR3IDgHmEAAYASABEglqAfd\\_BwE](https://covid19.who.int/?gclid=EA1aIQobChMizMeUx9fv8gIVxYJLBR3IDgHmEAAYASABEglqAfd_BwE).
27. Chen Y, Cheng J, Jiang Y, Liu K. A time delay dynamical model for outbreak of 2019-nCoV and the parameter identification. *Journal of Inverse and Ill-posed Problems* 2020; 28(2): 243-250.
28. Bai Y, Yao L, Wei T, Tian F, Jin D Y, Chen L, et al. Presumed Asymptomatic Carrier Transmission of COVID-19. *JAMA* 2020; 323(14):1406–1407. <https://doi.org/10.1001/jama.2020.2565>
29. Anastassopoulou C, Russo L, Tsakris A, Siettos C. Data-based analysis, modelling and forecasting of the COVID-19 outbreak. *PloS one* 2020; 15(3): e0230405.
30. Banerjee D, Rai M. Social isolation in Covid-19: The impact of loneliness. (2020)
31. Yafia R. Modelling and Dynamics in Epidemiology, COVID19 with Lockdown and Isolation Effect: Application to Moroccan Case. *COVID19 with Lockdown and Isolation Effect: Application to Moroccan Case (April 29, 2020)*.
32. Sameni R. Mathematical modelling of epidemic diseases; a case study of the COVID-19 corona virus. *arXiv preprint arXiv:2003.11371*. (2020).
33. Adhikari R, Agrawal RK. An introductory study on time series modelling and forecasting. *arXiv preprint arXiv:1302.6613*. (2020).
34. Cao J, Jiang X, Zhao B. Mathematical modelling and epidemic prediction of COVID-19 and its significance to epidemic prevention and control measures. *Journal of Biomedical Research & Innovation* 2020; 1(1):1-19.
35. Chowdhury A, Som S, Das A, Das A, Bose H, Bose R, et al. Impact of Lockdown Due to Spread of Covid-19 in India.
36. Chatterjee P, Mukherjee S, Bose R, Roy S. A Review on Information Security in Cloud Based System during Covid-19 Pandemic.



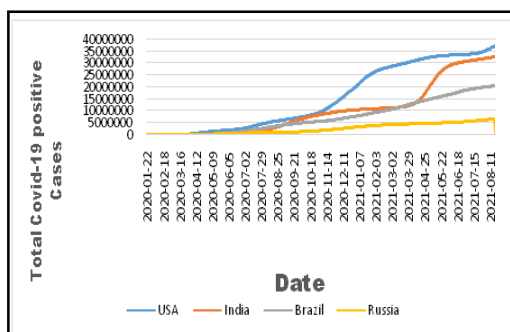


**Sandip Roy et al.,**

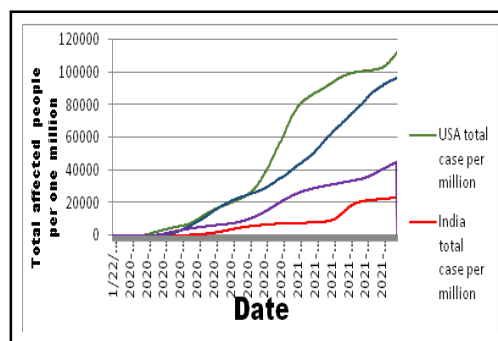
37. Banerjee R, Roy S, Nandi S. Approaches to Mitigate the Impacts of Highly Contagious Disease COVID-19 Using Machine Learning Algorithm.
38. Hethcote HW. The Mathematics of Infectious Diseases. *SIAM Review* 2020; 42(4): 599–653. <http://www.jstor.org/stable/2653135>
39. Kumar M, Anand M. AN APPLICATION OF TIME SERIES ARIMA FORECASTING MODEL FOR PREDICTING SUGARCANE PRODUCTION IN INDIA. *Studies in Business and Economics* 2020;9: 81-94.
40. PatraA, Ravi KS, Chaudhary P. COVID 19 reflection/experience on teaching–learning and assessment: story of anatomy teachers in India. *Anatomical science international* 2021; 96(1): 174-175.
41. Chakraborty C, Agoramoorthy G. India’s cost-effective COVID-19 vaccine development initiatives. *Vaccine* 2020; 38(50): 7883.
42. MarimuthuS, Joy M, Malavika B, Nadaraj A, Asirvatham ES, Jeyaseelan L. Modelling of reproduction number for COVID-19 in India and high incidence states. *Clinical epidemiology and global health* 2021; 9:57–61. <https://doi.org/10.1016/j.cegh.2020.06.012>
43. Victor PJ, MathewsKP, Paul H, Mammen JJ, Murugesan M. Protective effect of COVID-19 vaccine among health care workers during the second wave of the pandemic in India. In *Mayo Clinic Proceedings* 2021, 96 (9): 2493-2494.
44. Kashte S, Gulbake A, El-Amin III SF, Gupta A. COVID-19 vaccines: rapid development, implications, challenges and future prospects. *Human cell* 2020;1-23.

**Table 1. Depiction of Survival rate and fatality rate with population for most affected countries**

Country	Population	Average survival rate from corona virus disease per day before vaccination	Average fatality rate from corona virus disease per day before vaccination	Average survival rate from corona virus disease per day during 12 <sup>th</sup> February 2021 to 19 <sup>th</sup> August, 2021 after starting vaccination	Average fatality rate due to corona virus disease per day during January 2020 to 12 <sup>th</sup> February 2021 after starting vaccination	Average predicted survival rate from corona virus disease per day during August 2021 to August 2022	Average predicted fatality rate from corona virus disease per day during August 2021 to August 2022
USA	33.10 crores	99.862257	0.1377428	99.99625	0.003668167	99.99	0.001687668
Russia	14.59 crores	99.97	0.027512	99.99046	0.009477	99.960794	0.038974342
India	138 crores	99.91	0.08	99.993	0.006	99.994	0.0057
Brazil	21.25 crores	99.87	0.125	99.987	0.012247	99.994	0.005908



**Figure-1: Total Covid-19 Positive Cases during first and second wave of pandemic**



**Fig 2: Total infected people in country wise per million upto 19.08.2021**





Sandip Roy et al.,

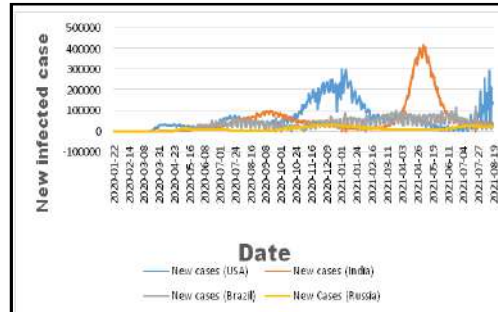


Fig 3: Country wise newly infected cases upto 19.08.2021

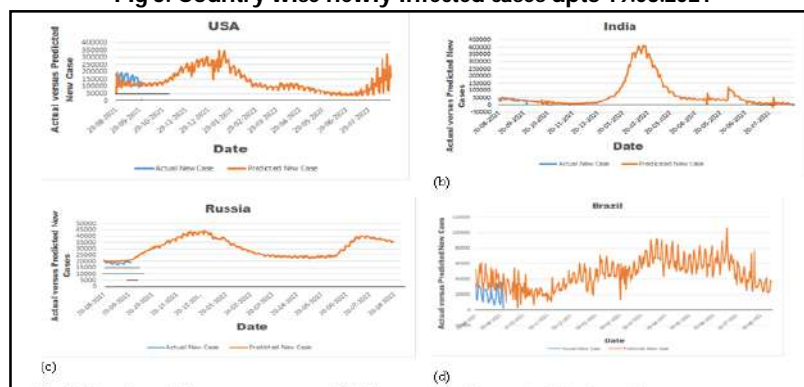


Fig 4: Date-wise actual new cases versus predicted new cases in four most affected countries

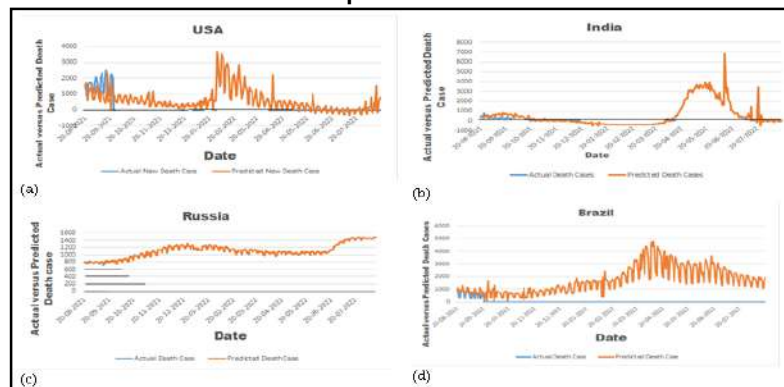


Fig 5: Date-wise actual death cases versus predicted death cases in four most affected countries.

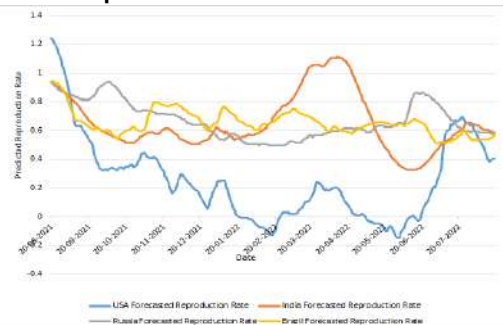


Fig 6: Date-wise predicted reproduction rate in four most affected countries





## Numerical Study of Tumor Growth using Integral Equations

John Abhishek Masih<sup>1</sup>, Manish Sharma<sup>2</sup>, Rajiv Phillip<sup>3</sup>, Sanjay Kumar Pandey<sup>4</sup> and Runit Isaac<sup>5\*</sup>

<sup>1</sup>Assistant Professor, Department of Mathematics, St. John's College, Agra, U.P, India.

<sup>2</sup>Assistant Professor, Department of Mathematics, SLBS Degree College, Gonda, U.P, India.

<sup>3</sup>Associate Professor, Department of Mathematics, St. John's College, Agra, U.P, India.

<sup>4</sup>Associate Professor and Head, Department of Mathematics, SLBS Degree College, Gonda, U.P, India.

<sup>5</sup>Department of Chemistry, Sam Higginbottom University of Agriculture Technology and Sciences, Prayagraj, Uttar Pradesh, India.

Received: 15 Nov 2021

Revised: 20 Dec 2021

Accepted: 13 Jan 2022

### \*Address for Correspondence

**Runit Isaac**

Department of Chemistry,

Sam Higginbottom University of Agriculture Technology and Sciences,

Prayagraj, Uttar Pradesh, India.

Email: jamasih\_sjc@stjohnscollegeagra.in



This is an Open Access Journal / article distributed under the terms of the **Creative Commons Attribution License** (CC BY-NC-ND 3.0) which permits unrestricted use, distribution, and reproduction in any medium, provided the original work is properly cited. All rights reserved.

### ABSTRACT

Mathematical modeling is being used widely to enhance quantitative understanding of biological processes and bio-medical phenomena. This quantitative knowledge can be applied in both clinical and experimental settings. One important application of modeling exercises is in the area of cancer biology. An increment of unwanted cells in the body is known as tumor. Several mathematical models have been developed to represent different aspect of cancer. Those models vary from a simple model simulating tumor growth to complicated models including many important processes of tumor growth and its treatment. In this paper, we discuss a mathematical model of tumor governed by an integral equation for growth of tumor cells. The work focuses the mathematical methods to provide the stability of tumor cells with their aging. The average rate of growth ( $r_0$ ) of individual investigate the stability of the model. If the value of  $r_0 > 0$ , the number of tumor cells of development group increases and if the value of  $r_0 < 0$ , the number of tumor cells of development group tends to zero. The system is unstable and this result have been analyzed graphically.

**Keywords:** Mathematical Modelling, Stability, Integral Equation, Tumor Cells, MATLAB.

### INTRODUCTION

In the present scenario, world observe that the most serious threat is tumor disease. According to WHO reports in 2018, the cancer burden is estimated to have risen to 18.1 million new cancer cases and approximately 9.6 million deaths. The rate of convergence for the Lotka-Sharpe-McKendrick model is discussed for the discrete time case. Also, persistent age distribution is estimated in terms of the age-dependent mortality and fertility [1]. The mathematical





**John Abhishek Masih et al.,**

model studied the age-structured tumor cell populations with proliferating and quiescent phases at the avascular stage in vitro. Also, the model provides the information of new born cells with age zero. The uniqueness and stability of the steady state also investigate the growth of the tumor cells [2]. The study of vertical transmission of age structured population is given by Hisashi Inaba. A mathematical model for the spread of a directly transmitted disease in an age structured population, for which infected population is recovered with permanent immunity by an age specific schedule, has been presented in [5]. In this model, the endemic steady states are forwardly bifurcated from the disease-free steady state when  $r_0$  crosses the unity [5]. Jan R. Aunan (et al 2017) has worked on the biology of the aging and cancer. Aging is the inevitable time dependent decline in physiological organ function and is a main risk factor for the growth of cancer. While both cancer cells and aging cells are fundamentally opposite. Cancer cells can be through of as hyperactive cells with advantageous mutations, rapid cell division and increased energy consumption, while aged cells are hypoactive with accumulated disadvantageous mutations, cell division inability and a decreased ability for energy production and consumption. Both cells are interlinked and mechanisms as well as some strategies are same [6]. S. I. Oke (et al 2018) provided his work on optimal control policy for breast cancer. A four-dimensional compartmental deterministic model was formed and used to monitor the dynamics of breast cancer [7]. Mathematical models have been developed to represent some aspects of cancer [8–11]. V. Cristini et al. 2009 developed a mixture model for the growth of tumor and governing equations are of Cahn Hilliard type. Gradient stable discretization scheme is used so that nonlinear equations are solvable for every large time steps and used a nonlinear multilevel method which is of an optimal order  $O(N)$  where  $N$  is the number of grid points. Ghosh D. et al. 2017, discussed the tumor growth and used the delay modeling on the development of growth of tumor in microenvironment. He also applied the Hopf bifurcation technique to check the stability [13]. In order to understand the mathematical model of tumor growth and analyze the biological complexity to the growth of the tumor. Those models vary from a simple model trying to simulate the growth of tumor volume to sophisticated models including many biologically important molecular processes [7, 8].

## MATERIAL AND METHOD

### Mathematical Model

Definition of parameters and variables

- (i)  $T(x, t)$  be the numbers of tumor cells at time  $t$ , where ages lie between  $x$  and  $x + dx$
- (ii)  $G(t)$  be the growth/development of tumor cells in the interval  $(t, t + dt)$
- (iii)  $0xP$  define the probability of tumor cells, who is newly developed and survive for duration 'x' years.
- (iv)  $(x - t)tP$  define the probability of a tumor cells of age  $(x - t)$  with  $x > t$  who will survive for  $t$  years and attain the age 'x'.
- (v)  $\zeta(x)$  be the average number of tumor growth to each tumor cell of age  $x$  in the time interval  $(t, t + dt)$ . Here, the functions  $0xP$ ,  $(x - t)tP$  and  $\zeta(x)$  are supposed to be given and we have to obtain the growth function  $G(t)$ .
- (vi) If  $x$  lies between 0 and  $t$ , the number of tumor cells  $T(x, t)dt$  is obtained in the age interval  $(x, x + dx)$  by the growth of tumor cell  $G(t)$  in the time interval  $(t - x, t - x - dx)$ , who have survived for  $x$  years so that, we have the desired equation.

The total number of tumor cells at time  $t$  is defined as

$$T(x, t) = G(t - x)0xPdx, \quad 0 \leq x \leq t \quad (1)$$

If  $x > t$ , the number of tumor cells  $T(x, t)dx$  is obtained by the growth of tumor cells in the interval  $(x - t, x + dx - t)$  initially, who have survived for  $t$  years.

$$T(x, t) = T(x - t, 0)(x - t)tPdx, \quad x > t \quad (2)$$

Now,  $G(t)dt$  represents the growth of tumor cells in the interval  $(t, t + dt)$ , therefore the growth of the tumor cells is given by







**John Abhishek Masih et al.,**

$$\begin{aligned}
 G(t)dt &= \int_0^\infty T(x,t)\zeta(x)dx \Rightarrow G(t)dt = \int_0^t T(x,t)\zeta(x)dx + \int_t^\infty T(x,t)\zeta(x)dx \\
 &= \int_0^t G(t-x)0xP\zeta(x)dx + \int_t^\infty T(x-t,0)(x-t)tP\zeta(x)dx \\
 G(t)dt &= \int_0^t G(t-x)0xP\zeta(x)dx + \int_t^\infty T(x,0)xtP\zeta(x)dx \\
 G(t)dt &= \int_0^t G(t-x)0xP\zeta(x)dx + \phi_2(t) \tag{3}
 \end{aligned}$$

Now we define two functions  $\phi_1(x)$  and  $\phi_2(t)$  as

$$\phi_1(x) = 0xP\zeta(x)dx \tag{4}$$

$$\phi_2(t) = \int_t^\infty T(x,0)xtP\zeta(x)dx \tag{5}$$

The function  $\phi_1(x)$  is called the parenthood function, which is supposed to be known. Also, equation (3) is nonhomogeneous integral equation and satisfied the Lipschitz condition.

$$\|kG_1 - kG_2\| \leq k\|G_1 - G_2\|, \quad k > 0.$$

Where k is any positive constant. Rewrite the integral equation in the form

$$G = T^*G \tag{6}$$

$$\text{Where the growth function } G \text{ is also defined as } T^*G = T^*kG + \phi_2 \tag{7}$$

Above equation (7) is not linear for the operator  $T^*$ . Obviously, if G is fixed point of the equation (7), then G is a solution of (3).

$$\begin{aligned}
 \|(T^*G_1 - T^*G_2)\| &= \|(T^*kG_1 + \phi_2) - (T^*kG_2 + \phi_2)\| \\
 &= \|T^*kG_1 - T^*kG_2\| \\
 &= |T^*| \|kG_1 - kG_2\| \\
 &\leq |T^*|k\|G_1 - G_2\|
 \end{aligned}$$

If  $|T^*|k < 1$ , then the operator  $T^*$  is contraction and according to Banach fixed point theorem, there exist a unique point of (7). This point is also a solution of (6). So, we can write  $|T^*| < \frac{1}{k}$  that is sufficiently very small  $|T^*|$ . Therefore we consider  $\phi_2$  as zero. The age distribution of tumor cells is supposed to be known at  $t = 0$ ,  $T(x,0)$  is also known. Finally, we get

$$G(t) = \int_0^t G(t-x)\phi_1(x)dx \tag{8}$$

This equation is known as homogeneous linear integral equation for the study of the growth of the tumor cell with aging 'x'.

## RESULT AND DISCUSSION

### Analysis of Mathematical Model

First, we consider  $G(t) = e^{rt}$  be the solution of the equation (8), then we get

$$G(t) = e^{rt} \int_0^t e^{-rx} 0xP\zeta(x)dx \tag{9}$$

If the root  $r_0$  is the greater than the real part of any other root of (8), when t is large,

$$G(t) = A_0 e^{r_0 t} \tag{10}$$

and from the equation (1), we have

$$T(x,t) = A_0 e^{r_0(t-x)} 0xP \tag{9}$$

So that the ratios of the tumors cell in the age group  $x$  to  $x + dx$  to the total population is

$$\frac{T(x,t)}{\int_0^\infty T(x,t)dx} = \frac{e^{-r_0 x} 0xP}{\int_0^\infty e^{-r_0 x} 0xP dx} \tag{10}$$

Right hand side is independent of time 't' and therefore gives a stable age distribution. If the value of  $r_0 > 0$ , the number of tumor cells of development group increases and if the value of  $r_0 < 0$ , the number of tumor cells of





**John Abhishek Masih et al.,**

development group tends to zero. According to GLOBOCAN 2018 and ICMR record the value of  $r_0 = 1.475 > 1$ , therefore the number of tumor cells of development group increases [3, 4].

### Graphical Analysis

This three-dimensional graph for the parameter values is given in above figure 1. Here the top portion of the graph shows that the growth of the tumor cells in host body. This 3D figure represents the growth of infected cells in a fixed interval is seen in the Figure 2. This is a top view of the growth of tumor cells, in which we can easily find that the given model is unstable due to the rapid growth of the tumor cells id depicted in Figure 3. Finally, we observed in figure 4 that these four graphs in three dimensional shows multiple numbers of tumor cell when the age of tumor cell will vary from zero to 1, 2, 3 and 4 years. Finally, this figure 5 shows the number of tumor cell will increase when the age of tumor cell will vary from zero to 1, 2, 3 and 4 years and then this model will be unstable.

### CONCLUSION

The right-hand side of equation (10) is independent of time 't', which gives a stable age distribution in the tumor cell population. If the value of  $r_0 > 0$ , the number of tumor cells of development group increases and if the value of  $r_0 < 0$ , the number of tumor cells of development group tends to zero. According to GLOBOCAN 2018 and ICMR the value of  $r_0 = 1.475 > 1$ , the number of tumor cells will increase. Hence the system is unstable and this result have been proved graphically also.

### REFERENCES

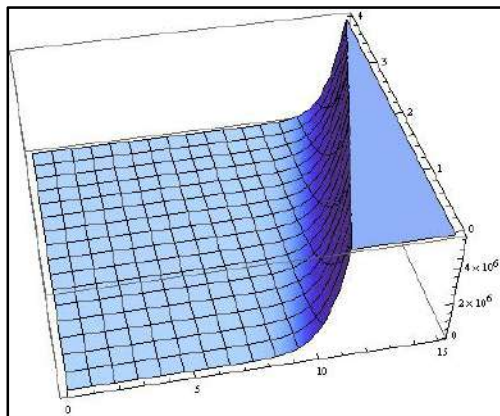
1. Alaoui, L. and Khaladi, M., 2015. Rate of convergence to equilibria of the Lotka-Sharpe-McKendrick model. *International Journal of Mathematical Analysis*, 9(1), pp. 39-60.
2. Liu, Z., Chen, J., Pang, J., Bi, P. and Ruan, S., 2018. Modeling and Analysis of a Nonlinear Age-Structured Model for Tumor Cell Populations with Quiescence. *Journal of Nonlinear Science*, 28(5), pp. 1763-1791.
3. <http://cancerindia.org.in/cancer-statistics/>
4. <https://www.icmr.nic.in/sites/default/files/Nov1.pdf>
5. Inaba, H., 2006. Mathematical analysis of an age-structured SIR epidemic model with vertical transmission. *Discrete and Continuous Dynamical Systems Series B*, 6(1), p.69.
6. Aunan, J.R., Cho, W.C. and Søreide, K., 2017. The biology of aging and cancer: a brief overview of shared and divergent molecular hallmarks. *Aging and disease*, 8(5), p.628.
7. Oke, S., Matadi, M. and Xulu, S., 2018. Optimal control analysis of a mathematical model for breast cancer. *Mathematical and Computational Applications*, 23(2), p.21.
8. Kim Y, Magdalena AS, Othmer HG. A hybrid model for tumor spheroid growth in vitro I: theoretical development and early results. *Math. Models Methods Appl. Sci.* 2007;17:1773–98. doi: 10.1142/S0218202507002479.
9. Cristini V, Li X, Lowengrub JS, Wise SM. Nonlinear simulations of solid tumor growth using a mixture model: invasion and branching. *J Math Biol.* 2009;58(4–5):723–63. doi: 10.1007/s00285-008-0215-x.
10. Deisboeck TS, Stamatakis GS. Editors. Multiscale cancer modeling. Chapman and hall/CRC mathematical and computational biology (book 34) Boca Rayton: CRC Press; 2010.
11. Kim Y, Stolarska MA, Othmer HG. The role of the microenvironment in tumor growth and invasion. *Prog Biophys Mol Biol.* 2011;106(2):353–79. doi: 10.1016/j.pbiomolbio.2011.06.006.
12. Lashari, A.A., Hattaf, K. and Zaman, G., 2012. A delay differential equation model of a vector borne disease with direct transmission. *Int. J. Ecol. Econ. Stat*, 27, pp.25-35.
13. Ghosh, D., Khajanchi, S., Mangiarotti, S., Denis, F., Dana, S.K. and Letellier, C., 2017. How tumor growth can be influenced by delayed interactions between cancer cells and the micro-environment? *BioSystems*, 158, pp.17-30.
14. De Pillis, L.G. and Radunskaya, A., 2001. A mathematical tumor model with immune resistance and drug therapy: an optimal control approach. *Computational and Mathematical Methods in Medicine*, 3(2), pp.79-100.



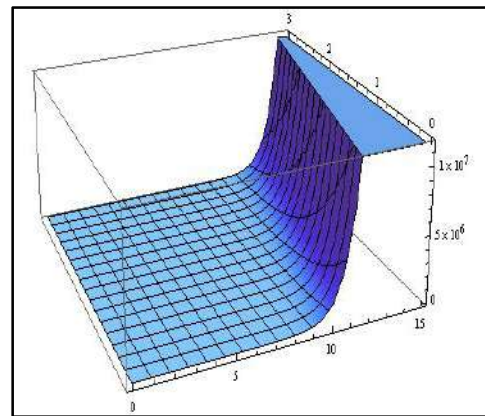


**John Abhishek Masih et al.,**

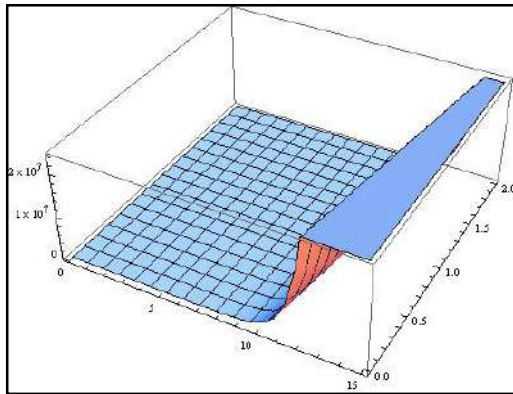
15. Byrne, H.M., 1997. The effect of time delays on the dynamics of avascular tumor growth. *Mathematical biosciences*, 144(2), pp.83-117.
16. Xu, S., Wu, X., Bai, M. and Zhao, X., 2013. Analysis of a time-delayed mathematical model for tumour growth with inhibitors. *Applicable Analysis*, 92(4), pp.703-717.
17. Jack, K., 1981. HALE, "Theory of Functional Differential Equations," *Applied Mathematical Sciences*, 3.
18. A. Friedman and F. Reitich, Analysis of a mathematical model for the growth of tumours, *J. Math. Biol.* 38 (1999), pp. 262–284.
19. Panetta, J.C., 1998. A mathematical model of drug resistance: heterogeneous tumors. *Mathematical biosciences*, 147(1), pp.41-61.
20. Rosen, R., 1986. "Role of mathematical modeling in protocol formulation in cancer chemotherapy". *Cancer treatment reports*, 70(12), pp.1461-1462.



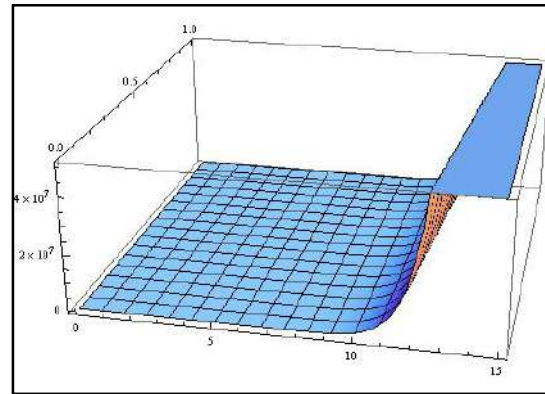
**Figure 1:** This three-dimensional graph for the parameter values



**Figure 2:** This 3D figure represents the growth of infected cells in a fixed interval



**Figure 3:** Model is unstable due to the rapid growth of the tumor cells

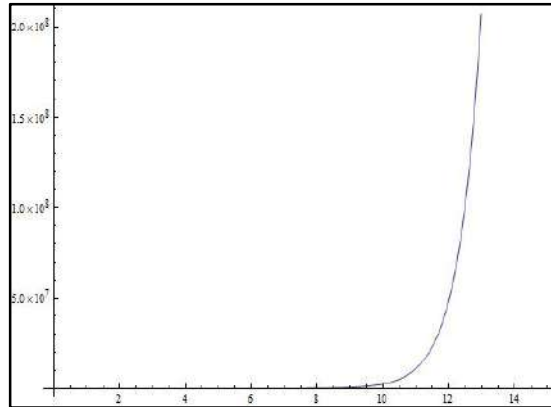


**Figure 4:** Variations in age of tumor cell with time





**John Abhishek Masih et al.,**



**Figure 5**





## Bipolar Fuzzy S-Hausdorff Space

Muthamizhselvi .S<sup>1\*</sup> and V.M.Vijayalakshmi<sup>2</sup>

<sup>1</sup>Research Scholar, Department of Mathematics, Avinashilingam Institute for Home Science and Higher Education for Women, Coimbatore - 641043, Tamil Nadu, India.

<sup>2</sup>Assistant Professor, Department of Science and Humanities, Avinashilingam Institute for Home Science and Higher Education for Women, Coimbatore - 641043, Tamil Nadu, India.

Received: 21 Dec 2021

Revised: 11 Jan 2022

Accepted: 21 Jan 2022

### \*Address for Correspondence

#### Muthamizhselvi .S

Research Scholar,

Department of Mathematics,

Avinashilingam Institute for Home Science and Higher Education for Women,

Coimbatore - 641043, Tamil Nadu, India.

Email: muthamilselvi394@gmail.com



This is an Open Access Journal / article distributed under the terms of the **Creative Commons Attribution License** (CC BY-NC-ND 3.0) which permits unrestricted use, distribution, and reproduction in any medium, provided the original work is properly cited. All rights reserved.

### ABSTRACT

Aim of this article is to analyse bipolar fuzzy S-Hausdorff space by extending the definition of S-Hausdorff space introduced by Srivastava *et al* [14] and to prove some basic properties.

**Keywords:** BFS, BFT, bipolar fuzzy S- Hausdorff space( $BFS - H$ ).

## INTRODUCTION

Concept of fuzzy set was proposed by Zadeh [15] in 1965. Chang [3] studied the concept of fuzzy topology in the year 1968. BFS was proposed by Zhang [16] in 1994. Kim, *et al.*[8] defined  $BF_p$  and analysed the concept of BFT in Chang's sense [3] in 2018. In section 2, preliminary definitions regarding fuzzy set, BFS and  $BF_p$  are given. In section 3, bipolar fuzzy S- Hausdorff space is studied by extending the definition of S-Hausdorff space introduced by Srivastava *et al*[14] and obtained result analogues to the results of S- Hausdorff space.

### Preliminary Definitions

#### Definition : 2.1 [15]

Let  $X$  be a non-empty set. Let  $I = [0,1]$ . A FS in  $X$  is a map defined as  $f: X \rightarrow I$ . Set of all fuzzy sets (FS) is designated by  $I^X$ .

#### Definition : 2.2[9]

A pair  $A_{bp} = (A_{bp}^p, A_{bp}^n)$  is called BFS in  $X$ , where

$A_{bp}^p$  is a mapping from  $X$  to  $[0,1]$  &  $A_{bp}^n$  is a mapping from  $X$  to  $[-1,0]$ . Set of all bipolar fuzzy set in  $X$  is designated by BFS.





**Muthamizhselvi and Vijayalakshmi**

**Definition : 2.3[9]**

The **BF null set** denoted by  $0_{bp} = (0_{bp}^p, 0_{bp}^n)$  is a BFSin  $X$  defined as  $0_{bp}^p(x) = 0$  and  $0_{bp}^n(x) = 0$ , for each  $x \in X$ .

**Definition: 2.4[9]**

The **BFwhole set** denoted by  $1_{bp} = (1_{bp}^p, 1_{bp}^n)$  is a BFSin  $X$  defined as,  $1_{bp}^p(x) = 1$  and  $1_{bp}^n(x) = -1$ , for each  $x \in X$ .

**Definition: 2.5[9]**

Let  $A_{bp} = (A_{bp}^p, A_{bp}^n)$ ,  $B_{bp} = (B_{bp}^p, B_{bp}^n)$  be BFSin  $X$ , Then  $A_{bp}$  is a **subset** of  $B_{bp}$ , denoted by  $A_{bp} \subset B_{bp}$  is defined as  $A_{bp}^p(x) \leq B_{bp}^p(x)$  and  $A_{bp}^n(x) \geq B_{bp}^n(x)$ , for each  $x \in X$ .

The **complement** of  $A_{bp}$  is denoted by  $A_{bp}^c = ((A_{bp}^c)^p, (A_{bp}^c)^n)$  is a BFSin  $X$  defined as  $(A_{bp}^c)^p(x) = 1 - A_{bp}^p(x)$  and  $(A_{bp}^c)^n(x) = -1 - A_{bp}^n(x)$ , for each  $x \in X$ .

**Intersection** of  $A_{bp}$  &  $B_{bp}$ , denoted by  $A_{bp} \cap B_{bp}$  is a BFSin  $X$  defined as

$$(A_{bp} \cap B_{bp})(x) = (A_{bp}^p(x) \wedge B_{bp}^p(x), A_{bp}^n(x) \vee B_{bp}^n(x)), \text{ for each } x \in X.$$

**Union** of  $A_{bp}$  &  $B_{bp}$ , denoted by  $A_{bp} \cup B_{bp}$ , is a BFSin  $X$  defined as

$$(A_{bp} \cup B_{bp})(x) = (A_{bp}^p(x) \vee B_{bp}^p(x), A_{bp}^n(x) \wedge B_{bp}^n(x)), \text{ for each } x \in X.$$

**Intersection** of  $((A_{bp})_\lambda)_{\lambda \in \Lambda}$ , a collection of BFsubsets in  $X$  denoted by  $\bigcap_{\lambda \in \Lambda} (A_{bp})_\lambda$  is a BFS in  $X$  defined as

$$\left(\bigcap_{\lambda \in \Lambda} (A_{bp})_\lambda\right)(x) = \left(\bigwedge_{\lambda \in \Lambda} \left((A_{bp})_\lambda^p\right)(x), \bigvee_{\lambda \in \Lambda} \left((A_{bp})_\lambda^n\right)(x)\right), \text{ for each } x \in X.$$

**Union** of  $((A_{bp})_\lambda)_{\lambda \in \Lambda}$ , a collection of BFsubsets in  $X$  denoted by  $\bigcup_{\lambda \in \Lambda} (A_{bp})_\lambda$ , is a BFS in  $X$  defined as

$$\left(\bigcup_{\lambda \in \Lambda} (A_{bp})_\lambda\right)(x) = \left(\bigvee_{\lambda \in \Lambda} \left((A_{bp})_\lambda^p\right)(x), \bigwedge_{\lambda \in \Lambda} \left((A_{bp})_\lambda^n\right)(x)\right), \text{ for each } x \in X.$$

**Definition: 2.6[8]**

Let  $\tau_{\mathfrak{B}} \subset \text{BFS}$ . Then  $\tau_{\mathfrak{B}}$  is called a BFT on  $X$  iff  $\tau_{\mathfrak{B}}$  satisfies the following requirements:

$$0_{bp}, 1_{bp} \in \tau_{\mathfrak{B}}.$$

$$A_{bp}, B_{bp} \in \tau_{\mathfrak{B}} \text{ implies } A_{bp} \cap B_{bp} \in \tau_{\mathfrak{B}}.$$

$$\bigcup_{\lambda \in \Lambda} (A_{bp})_\lambda \in \tau_{\mathfrak{B}}, \text{ for any } \left((A_{bp})_\lambda\right)_{\lambda \in \Lambda} \subset \tau_{\mathfrak{B}}.$$

Then  $(X, \tau_{\mathfrak{B}})$  is called a **BFT space**. Set of all **BF open set** in  $X$  is denoted as  $BFOS$ .

$A_{bp} \in \text{BFS}$  is said to be closed in  $X$ , if  $A_{bp}^c \in \tau_{\mathfrak{B}}$ . Set of all BFtopologies on  $X$  is designated by BFT.

**Definition: 2.7[8]**

Let  $x \in X$ ,  $(\alpha, \beta) \in (0,1] \times [-1,0)$  and let  $A_{bp} \in \text{BFS}$ . Then

$x_{(\alpha, \beta)}$  is called a **BF<sub>p</sub>** in  $X$ , with the support of  $x$  has the value  $(\alpha, \beta)$ , if for each  $y \in X$ ,

$$[x_{(\alpha, \beta)}](y) = \begin{cases} (\alpha, \beta), & \text{if } y = x \\ (0,0), & \text{otherwise} \end{cases}$$

$x_{(\alpha, \beta)}$  is said to belong to  $A_{bp}$ , denoted by  $x_{(\alpha, \beta)} \in A_{bp}$ , if

$$A_{bp}^p(x) \geq \alpha \text{ and } A_{bp}^n(x) \leq \beta$$

Set of all **bipolar fuzzy points** in  $X$  designated by  $BF_p$ . Therefore

$$A_{bp} = \bigcup \{x_{(\alpha, \beta)} \in BF_p : x_{(\alpha, \beta)} \in A_{bp}\}, \text{ for each } A_{bp} \in \text{BFS}.$$

**Definition: 2.8[13]**

Let  $(X, \tau_{\mathfrak{B}})$  be a BFT. Let  $Y \subseteq X$ .





**Muthamizhselvi and Vijayalakshmi**

Let  $A_{bp} = (A_{bp}^p, A_{bp}^n) \in \tau_{\mathfrak{S}}$ . Define  $A_{bp}/Y = (A_{bp}^p/Y, A_{bp}^n/Y)$  such that  $(A_{bp}^p/Y)(z) = A_{bp}^p(z)$  and  $(A_{bp}^n/Y)(z) = A_{bp}^n(z)$ , for all  $z \in Y$ . Define  $(\tau_{\mathfrak{S}}/Y) = \{(A_{bp}/Y) \mid A_{bp} \in \tau_{\mathfrak{S}}\}$ . Then  $(\tau_{\mathfrak{S}}/Y)$  is said to be **BF subspace topology on Y** and  $(Y, \tau_{\mathfrak{S}}/Y)$  is said to be **BF subspace of  $(X, \tau_{\mathfrak{S}})$** .

**Definition: 2.9 [13]**

Let  $A_{bp} = (A_{bp}^p, A_{bp}^n)$  and  $B_{bp} = (B_{bp}^p, B_{bp}^n)$  be two BFSin  $X$  and  $Y$  respectively. Then **cartesian product** of  $A_{bp}$  &  $B_{bp}$  is a BFSin  $X \times Y$  denoted as  $A_{bp} * B_{bp}$  and is defined as  $A_{bp} * B_{bp} = (A_{bp}^p * B_{bp}^p, A_{bp}^n * B_{bp}^n)$  where  $(A_{bp}^p * B_{bp}^p)(x, y) = \min\{A_{bp}^p(x), B_{bp}^p(y)\}$  and  $(A_{bp}^n * B_{bp}^n)(x, y) = \max\{A_{bp}^n(x), B_{bp}^n(y)\}$  for every  $(x, y) \in X \times Y$ .

**Definition: 2.10 [13]**

Let  $(X, \tau_{\mathfrak{S}_1})$  and  $(Y, \tau_{\mathfrak{S}_2})$  be two BFTspaces. Then **product topology**  $\tau_{\mathfrak{S}_1} \times \tau_{\mathfrak{S}_2}$  on  $X \times Y$  is the BFTtopology having the collection  $\{A_{bp} * B_{bp} \mid A_{bp} \in \tau_{\mathfrak{S}_1}, B_{bp} \in \tau_{\mathfrak{S}_2}\}$  as a basis.

**Definition: 2.11 [13]**

Let  $\{(X_\lambda, \tau_{\mathfrak{S}_\lambda}) \mid (\lambda \in \Lambda)\}$  be a family of BFTspaces and  $X = \prod_{(\lambda \in \Lambda)} X_\lambda$ . Let  $\{(A_{bp})_\lambda = ((A_{bp})_\lambda^p, (A_{bp})_\lambda^n) \mid (\lambda \in \Lambda) \text{ and } (A_{bp})_\lambda \text{ is a BFS in } X_\lambda\}$ . Then their **product**  $\prod_{(\lambda \in \Lambda)} (A_{bp})_\lambda$  is a BFSin  $\prod_{(\lambda \in \Lambda)} X_\lambda$  defined as  $\prod_{(\lambda \in \Lambda)} (A_{bp})_\lambda = (\prod_{(\lambda \in \Lambda)} ((A_{bp})_\lambda^p), \prod_{(\lambda \in \Lambda)} ((A_{bp})_\lambda^n))$  where  $\prod_{\lambda \in \Lambda} ((A_{bp})_\lambda^p)(x_\lambda) = \min\{((A_{bp})_\lambda^p)(x_\lambda)\}$ , for all  $x \in \prod x_\lambda \in X$  and  $\prod_{\lambda \in \Lambda} ((A_{bp})_\lambda^n)(x_\lambda) = \max\{((A_{bp})_\lambda^n)(x_\lambda)\}$ , for all  $x \in \prod x_\lambda \in X$ . product topology on  $X$  is of the form  $\prod_{(\lambda \in \Lambda)} (A_{bp})_\lambda$  a basis **BFOS**, where  $(A_{bp})_\lambda \in \tau_{\mathfrak{S}_\lambda}$  and  $((A_{bp})_\lambda) = 1_{bp}$ , except for finitely many  $\lambda$ 's.

**Definition : 2.12 [14]**

A FTspace  $(X, \tau)$  is called **fuzzy S-Hausdorff**, if for any two FP distinct  $x_t, y_s$  in  $X$ , there exists  $f, g \in \tau$  such that  $x_t \in f, y_s \in g$  and  $f \wedge g = 0$ .

**Bipolar Fuzzy S-Hausdorff Space**

**Definition:3.1**

ABFTspace  $(X, \tau_{\mathfrak{S}})$  called **BFS-Hausdorff or BFS-T** or **BFS – H** if for any two distinct  $BFp^{X(\alpha, \beta)}, Y(y, \delta)$  in  $X$ , there exists two **BFOSA**  $A_{bp} = (A_{bp}^p, A_{bp}^n)$  and  $B_{bp} = (B_{bp}^p, B_{bp}^n) \in \tau_{\mathfrak{S}}$  such that  $x_{(\alpha, \beta)} \in A_{bp}, y_{(y, \delta)} \in B_{bp}$  that is  $A_{bp}^p(x) \geq \alpha, A_{bp}^n(x) \leq \beta, B_{bp}^p(y) \geq \gamma, B_{bp}^n(y) \leq \delta$  and  $A_{bp} \cap B_{bp} = 0_{bp}$ .

**Theorem:3.2**

Subspace of **BFS – H** is a **BFS – H**.

**Proof:**

Let  $(X, \tau_{\mathfrak{S}})$  be a **–H**. Let  $Y \subseteq X$

To prove:  $(Y, \tau_{\mathfrak{S}}/Y)$  is a bipolar fuzzy S-hausdorff space

Consider  $y_{(\alpha, \beta)}, z_{(y, \delta)} \in Y$  such that  $y_{(\alpha, \beta)} \neq z_{(y, \delta)}$  then  $y_{(\alpha, \beta)}, z_{(y, \delta)} \in X$ , there exists two bipolar fuzzy open sets

$A_{bp} = (A_{bp}^p, A_{bp}^n)$  and  $B_{bp} = (B_{bp}^p, B_{bp}^n) \in \tau_{\mathfrak{S}}$  such that

$A_{bp}^p(y) \geq \alpha, A_{bp}^n(y) \leq \beta, B_{bp}^p(z) \geq \gamma, B_{bp}^n(z) \leq \delta$  and  $A_{bp} \cap B_{bp} = 0_{bp}$ .

Since  $Y$  is a subspace of  $X$ .  $A_{bp}/Y, B_{bp}/Y \in \tau_{\mathfrak{S}}/Y$ , where





**Muthamizhselvi and Vijayalakshmi**

$$A_{bp}/Y = (A_{bp}^p/Y, A_{bp}^n/Y) \text{ and } B_{bp}/Y = (B_{bp}^p/Y, B_{bp}^n/Y)$$

$$\text{Therefore } (A_{bp}^p/Y)(y) = A_{bp}^p(y) \geq \alpha$$

$$(A_{bp}^n/Y)(y) = A_{bp}^n(y) \leq \beta$$

$$(B_{bp}^p/Y)(z) = B_{bp}^p(z) \geq \gamma$$

$$(B_{bp}^n/Y)(z) = B_{bp}^n(z) \leq \delta$$

Consider

$$(A_{bp}/Y) \cap (B_{bp}/Y) = ((A_{bp}^p/Y) \wedge (B_{bp}^p/Y), (A_{bp}^n/Y) \vee (B_{bp}^n/Y))$$

$$((A_{bp}^p/Y) \wedge (B_{bp}^p/Y))(y) = (A_{bp}^p/Y)(y) \wedge (B_{bp}^p/Y)(y), \text{ for all } y_{(\alpha,\beta)} \in Y \subseteq X$$

$$= (A_{bp}^p(y)) \wedge (B_{bp}^p(y)), \text{ for all } y_{(\alpha,\beta)} \in Y \subseteq X$$

$$= (A_{bp}^p \wedge B_{bp}^p)(y), \text{ for all } y_{(\alpha,\beta)} \in Y \subseteq X$$

$$= 0_{bp}^p(y), \text{ for all } y_{(\alpha,\beta)} \in Y \subseteq X$$

$$(A_{bp}^p/Y) \wedge (B_{bp}^p/Y) = 0^p$$

$$((A_{bp}^n/Y) \vee (B_{bp}^n/Y))(y) = (A_{bp}^n/Y)(y) \vee (B_{bp}^n/Y)(y), \text{ for all } y_{(\alpha,\beta)} \in Y \subseteq X$$

$$= (A_{bp}^n(y)) \vee (B_{bp}^n(y)), \text{ for all } y_{(\alpha,\beta)} \in Y \subseteq X$$

$$= (A_{bp}^n \vee B_{bp}^n)(y), \text{ for all } y_{(\alpha,\beta)} \in Y \subseteq X$$

$$= 0_{bp}^n(y), \text{ for all } y_{(\alpha,\beta)} \in Y \subseteq X$$

$$(A_{bp}^n/Y) \vee (B_{bp}^n/Y) = 0^n$$

$$\Rightarrow (A_{bp}/Y) \cap (B_{bp}/Y) = (0^p, 0^n) = 0_{bp}$$

Therefore subspace of a *BPFS – H* is *BPFS – H*.

**Theorem:3.3**

Product of two *BFS – H* is a *BFS – H*.

**Proof:**

Let  $(X, \tau_{\mathfrak{B}_1})$  and  $(Y, \tau_{\mathfrak{B}_2})$  be two *BFS – H*.

To prove:  $(X \times Y, \tau_{\mathfrak{B}_1} \times \tau_{\mathfrak{B}_2})$  is a bipolar fuzzy *S-Hausdorff space*

Consider two distinct bipolar fuzzy points  $y_{(\alpha,\beta)}, z_{(\gamma,\delta)} \in X \times Y$ ,

where  $y = (y_1, y_2)$  &  $z = (z_1, z_2)$ . Either  $y_1 \neq z_1$  or  $y_2 \neq z_2$ .

Assume  $y_1 \neq z_1$ , therefore there exists two bipolar fuzzy open sets

$A_{bp} = (A_{bp}^p, A_{bp}^n)$  and  $B_{bp} = (B_{bp}^p, B_{bp}^n)$  such that

$$A_{bp}^p(y_1) \geq \alpha, A_{bp}^n(y_1) \leq \beta, B_{bp}^p(z_1) \geq \gamma, B_{bp}^n(z_1) \leq \delta \text{ and}$$

$A_{bp} \cap B_{bp} = 0_{bp}$  where  $0_{bp}$  is a bipolar fuzzy null set in  $X$ .

$A_{bp} * 1_{bp} \in \tau_{\mathfrak{B}_1} \times \tau_{\mathfrak{B}_2}$ , since  $A_{bp} \in \tau_{\mathfrak{B}_1}, 1_{bp} \in \tau_{\mathfrak{B}_2}$  and

$B_{bp} * 1_{bp} \in \tau_{\mathfrak{B}_1} \times \tau_{\mathfrak{B}_2}$ , since  $B_{bp} \in \tau_{\mathfrak{B}_1}, 1_{bp} \in \tau_{\mathfrak{B}_2}$ , where

$$A_{bp} * 1_{bp} = (A_{bp}^p * 1_{bp}^p, A_{bp}^n * 1_{bp}^n) \text{ and } B_{bp} * 1_{bp} = (B_{bp}^p * 1_{bp}^p, B_{bp}^n * 1_{bp}^n)$$

Consider

$$(A_{bp}^p * 1_{bp}^p)(y_1, z_1) = \min\{A_{bp}^p(y_1), 1_{bp}^p(z_1)\} \geq \alpha$$

$$(A_{bp}^n * 1_{bp}^n)(y_1, z_1) = \max\{A_{bp}^n(y_1), 1_{bp}^n(z_1)\} \leq \beta$$

$$(B_{bp}^p * 1_{bp}^p)(y_2, z_2) = \min\{B_{bp}^p(y_2), 1_{bp}^p(z_2)\} \geq \gamma$$

$$(B_{bp}^n * 1_{bp}^n)(y_2, z_2) = \max\{B_{bp}^n(y_2), 1_{bp}^n(z_2)\} \leq \delta$$

Also

$$A_{bp} \cap B_{bp} = 0_{bp}$$

$$\Rightarrow ((A_{bp}^p \wedge B_{bp}^p), (A_{bp}^n \vee B_{bp}^n)) = 0_{bp}$$

$$\Rightarrow (A_{bp}^p \wedge B_{bp}^p)(x) = 0^p(x) \text{ and } (A_{bp}^n \vee B_{bp}^n)(x) = 0^n(x), \forall x \in X$$

$$\Rightarrow (A_{bp}^p)(x) \wedge (B_{bp}^p)(x) = 0^p(x) \text{ and } (A_{bp}^n)(x) \vee (B_{bp}^n)(x) = 0^n(x), \text{ for all } x \in X$$

$$\Rightarrow \text{either } (A_{bp}^p)(x) = 0^p(x) \text{ or } (B_{bp}^p)(x) = 0^p(x) \text{ and either } (A_{bp}^n)(x) = 0^n(x) \text{ or}$$

$$(B_{bp}^n)(x) = 0^n(x), \forall x \in X$$

$$\Rightarrow \text{for a BF whole set } 1_{bp} \text{ in } Y \text{ either } (A_{bp}^p)(x) \wedge (1_{bp}^p)(y) = 0 \text{ or}$$







**Muthamizhselvi and Vijayalakshmi**

$(B_{bp}^p)(x) \wedge (1_{bp}^p)(y) = 0$  and either  
 $(A_{bp}^n)(x) \vee (1_{bp}^n)(y) = 0$  or  $(B_{bp}^n)(x) \vee (1_{bp}^n)(y) = 0, \forall x \in X$  and  $y \in Y$   
 $\Rightarrow$  either  $(A_{bp}^p * 1_{bp}^p)(x, y) = 0$  or  $(B_{bp}^p * 1_{bp}^p)(x, y) = 0$  and either  
 $(A_{bp}^n * 1_{bp}^n)(x, y) = 0$  or  $(B_{bp}^n * 1_{bp}^n)(x, y) = 0, \forall (x, y) \in X \times Y$   
 $\Rightarrow (A_{bp}^p * 1_{bp}^p) \wedge (B_{bp}^p * 1_{bp}^p)(x, y) = 0$  and  
 $(A_{bp}^n * 1_{bp}^n) \vee (B_{bp}^n * 1_{bp}^n)(x, y) = 0$ , for all  $(x, y) \in X \times Y$   
 $\Rightarrow (A_{bp}^p * 1_{bp}^p) \cap (B_{bp}^p * 1_{bp}^p) = 0_{bp}$ , where  $0_{bp} \in X \times Y$ .  
 Therefore product of two  $BFS - H$  is a  $BFS - H$ .

**Theorem:3.4**

Arbitrary product of  $BFS - H$  is a  $BFS - H$ .

**Proof:**

Let  $\{(X_\lambda, \tau_{\mathfrak{B}\lambda}) \mid \lambda \in \Lambda\}$  be a set of  $BFS - H$

Let  $X = \prod_{(\lambda \in \Lambda)} X_\lambda$  &  $\tau_{\mathfrak{B}} = \prod_{(\lambda \in \Lambda)} (\tau_{\mathfrak{B}\lambda})$ .

Consider two distinct bipolar fuzzy points  $(x_\lambda)_{(\alpha, \beta)}, (y_\lambda)_{(\gamma, \delta)} \in \prod_{\lambda \in \Lambda} X_\lambda$ , for all  $\lambda \in \Lambda$ .

Therefore  $(x_\mu)_{(\alpha, \beta)} \neq (y_\mu)_{(\gamma, \delta)}$  for some  $\mu \in \Lambda$ . Therefore there exists two bipolar fuzzy open sets,

$$\begin{aligned}
 (A_{bp})_\mu &= ((A_{bp})_\mu^p, (A_{bp})_\mu^n) \text{ and } (B_{bp})_\mu = ((B_{bp})_\mu^p, (B_{bp})_\mu^n) \in \tau_{\mathfrak{B}\mu} \text{ such that} \\
 ((A_{bp})_\mu^p)(x_\mu) &\geq \alpha, ((A_{bp})_\mu^n)(x_\mu) \leq \beta, ((B_{bp})_\mu^p)(y_\mu) \geq \gamma, ((B_{bp})_\mu^n)(y_\mu) \leq \delta \text{ and} \\
 (A_{bp})_\mu \cap (B_{bp})_\mu &= (0_{bp})_\mu
 \end{aligned}$$

Let  $A_{bp} = \prod_{\lambda \in \Lambda} ((A_{bp})_\lambda)$ , where  $(A_{bp})_\lambda = (1_{bp})_\lambda$  for  $\lambda \neq \mu$  and

$B_{bp} = \prod_{\lambda \in \Lambda} ((B_{bp})_\lambda)$ , where  $(B_{bp})_\lambda = (1_{bp})_\lambda$  for  $\lambda \neq \mu$ .

Then  $A_{bp}, B_{bp} \in \prod_{\lambda \in \Lambda} \tau_{\mathfrak{B}\lambda}$

$$\begin{aligned}
 \prod_{(\lambda \in \Lambda)} ((A_{bp})_\lambda^p)(x_\lambda) &= \min\{((A_{bp})_\lambda^p)(x_\lambda)\}, \forall \lambda \in \Lambda \\
 &= ((A_{bp})_\mu^p)(x_\mu) \geq \alpha, \text{ for some } \mu \in \Lambda
 \end{aligned}$$

$$\prod_{\lambda \in \Lambda} ((A_{bp})_\lambda^p)(x_\lambda) \geq \alpha$$

$$\begin{aligned}
 \prod_{\lambda \in \Lambda} ((A_{bp})_\lambda^n)(x_\lambda) &= \max\{((A_{bp})_\lambda^n)(x_\lambda)\}, \forall \lambda \in \Lambda \\
 &= ((A_{bp})_\mu^n)(x_\mu) \leq \beta, \text{ for some } \mu \in \Lambda
 \end{aligned}$$

$$\prod_{\lambda \in \Lambda} ((A_{bp})_\lambda^n)(x_\lambda) \leq \beta$$

$$\begin{aligned}
 \prod_{\lambda \in \Lambda} ((B_{bp})_\lambda^p)(y_\lambda) &= \min\{((B_{bp})_\lambda^p)(y_\lambda)\}, \forall \lambda \in \Lambda \\
 &= ((B_{bp})_\mu^p)(y_\mu) \geq \gamma, \text{ for some } \mu \in \Lambda
 \end{aligned}$$

$$\prod_{\lambda \in \Lambda} ((B_{bp})_\lambda^p)(y_\lambda) \geq \gamma$$

$$\begin{aligned}
 \prod_{\lambda \in \Lambda} ((B_{bp})_\lambda^n)(y_\lambda) &= \max\{((B_{bp})_\lambda^n)(y_\lambda)\}, \forall \lambda \in \Lambda \\
 &= ((B_{bp})_\mu^n)(y_\mu) \leq \delta, \text{ for some } \mu \in \Lambda
 \end{aligned}$$

$$\prod_{\lambda \in \Lambda} ((B_{bp})_\lambda^n)(y_\lambda) \leq \delta$$

Consider

$$\begin{aligned}
 &\left( \prod_{(\lambda \in \Lambda)} (A_{bp})_\lambda \right) \cap \left( \prod_{(\lambda \in \Lambda)} (B_{bp})_\lambda \right) \\
 &= \left( \prod_{\lambda \in \Lambda} ((A_{bp})_\lambda^p) \wedge \prod_{\lambda \in \Lambda} ((B_{bp})_\lambda^p) \right) \cdot \left( \prod_{\lambda \in \Lambda} ((A_{bp})_\lambda^n) \vee \prod_{\lambda \in \Lambda} ((B_{bp})_\lambda^n) \right)
 \end{aligned}$$

Then





**Muthamizhselvi and Vijayalakshmi**

$$\begin{aligned}
 & \left( \left( \prod_{\lambda \in \Lambda} \left( (A_{bp})_{\lambda}^p \right) \right) \wedge \left( \prod_{\lambda \in \Lambda} \left( (B_{bp})_{\lambda}^p \right) \right) \right) (x_{\lambda}) \\
 &= \left( \prod_{(\lambda \in \Lambda)} \left( (A_{bp})_{\lambda}^p \right) (x_{\lambda}) \right) \wedge \left( \prod_{(\lambda \in \Lambda)} \left( (B_{bp})_{\lambda}^p \right) (x_{\lambda}) \right), \forall \lambda \in \Lambda \\
 &= \left( \min \left\{ \left( (A_{bp})_{\lambda}^p \right) (x_{\lambda}) \right\} \right) \wedge \left( \min \left\{ \left( (B_{bp})_{\lambda}^p \right) (x_{\lambda}) \right\} \right), \forall \lambda \in \Lambda \\
 &= \left( \left( (A_{bp})_{\mu}^p \right) (x_{\mu}) \right) \wedge \left( \left( (B_{bp})_{\mu}^p \right) (x_{\mu}) \right) \\
 &= \left( \left( \left( (A_{bp})_{\mu} \right)^p \right) \wedge \left( \left( (B_{bp})_{\mu} \right)^p \right) \right) (x_{\mu}) \\
 &= \left( (O_{bp})_{\mu}^p \right) (x_{\mu}) \\
 &= (O_{bp})_{\lambda}^p (x_{\lambda}) \\
 & \left( \prod_{\lambda \in \Lambda} \left( (A_{bp})_{\lambda}^n \right) \vee \prod_{\lambda \in \Lambda} \left( (B_{bp})_{\lambda}^n \right) \right) (y_{\lambda}) \\
 &= \left( \prod_{(\lambda \in \Lambda)} \left( (A_{bp})_{\lambda}^n \right) (y_{\lambda}) \right) \vee \left( \prod_{(\lambda \in \Lambda)} \left( (B_{bp})_{\lambda}^n \right) (y_{\lambda}) \right), \forall \lambda \in \Lambda \\
 &= \left( \max \left\{ \left( (A_{bp})_{\lambda}^n \right) (y_{\lambda}) \right\} \right) \vee \left( \max \left\{ \left( (B_{bp})_{\lambda}^n \right) (y_{\lambda}) \right\} \right), \forall \lambda \in \Lambda \\
 &= \left( (A_{bp})_{\mu}^n \right) (y_{\mu}) \vee \left( (B_{bp})_{\mu}^n \right) (y_{\mu}) \\
 &= \left( \left( (A_{bp})_{\mu}^n \right) \vee \left( (B_{bp})_{\mu}^n \right) \right) (y_{\mu}) \\
 &= \left( (O_{bp})_{\mu}^n \right) (x_{\mu}) \\
 &= (O_{bp})_{\lambda}^n (x_{\lambda}) \\
 & A_{bp} \cap B_{bp} = O_{bp} \\
 & \text{Therefore arbitrary product of } BFS - H \text{ is a } BFS - H.
 \end{aligned}$$

**CONCLUSION**

In the present work, bipolar fuzzy S-Hausdorff space is introduced and the related properties are proved.

**REFERENCES**

1. M. Akra, Bipolar fuzzy graphs, Inform Sci, 181, (2011) 5548-5564.
2. Azhagappan ,M. Kamaraj, Notes on bipolar-valued fuzzy RW-closed and bipolar-valued fuzzy RW-open sets in bipolar valued topological spaces, Int.J.Math.Arch, 7, (2016) 30-36.
3. L. Chang ,fuzzytopological spaces, J.Math.Anal.Appl., 24, (1968) 182-190.
4. T. E. Gantner, R.C. Steinlage, and Warren, R.H.,Compactness in fuzzy Topological Spaces, J.Math.Anal.Appl., 62, (1978) 547-562.
5. K. C. Chattopadhyay, R. N. Hazra, S. K. Samanta, Gradation of openness: Fuzzy topology. Fuzzy sets Syst. 49, (1992) 237-242.
6. B. Hutton, normality in fuzzy topological spaces, J.Math.Anal.Appl., 50, (1975) 74-79.
7. Y. B. Jun, C. H. Park, Filters of BCH – algebras based on bipolar – valued fuzzy sets, Int.Math.Forum, 4, (2009) 631-643.
8. J. Kim, S. K. Samanta, P. K. Lim, J .G .Lee ,K.. Hur, Bipolar fuzzy topological Spaces.,Ann.Fuzzy Math. Inform, 17, (2019) 205-229.
9. K. M. Lee, Comparison of Interval- valuedfuzzy sets, Intuitionistic fuzzy sets and bipolar-valued fuzzy sets, J.FuzzyLogic.Intell. Syst 14, (2004) 125-129.
10. J. G. Lee, K. Hur, Bipolar fuzzy relation, Mathematics, 2019,7,1044.
11. R. Lowen, Fuzzy topological spaces and Fuzzy Compactness, J.Math.Anal, 56, (1976) 621-633.
12. T. K. Mondal, S. K. Samanta, Topology of interval-valued fuzzy sets, IndianJ.PureAppl.Math, 30, (1999) 23-38.





**Muthamizhselvi and Vijayalakshmi**

13. S. Muthamizhselvi, V. M. Vijayalakshmi, Bipolar Fuzzy W-Hausdorff Space, *Advances and Applications in Mathematical Sciences*, Submitted
14. R. Srivatsava, S. N. Lal and A. K. Srivatsava, Fuzzy Hausdorff Topological Spaces, *Journal of Mathematical Analysis and Applications*, 81, (1981), 497-506.
15. L. A. Zadeh, Fuzzy sets, *Information and Control*, 8, (1965) 338-353.
16. W-R. Zhang, Bipolar fuzzy sets, *Proc. of IEEE*, (1998) 835-840.
17. W-R. Zhang, Bipolar fuzzy sets and relations: a computational framework for cognitive modeling and multiagent decision analysis, *Proc. of IEEE conference*, (1994) 305-309.





## Virtual Water Footprint: An Unexplored Paradoxical Dimension of Green and Blue Water Footprint in Milk Production

Priya Modi<sup>1</sup> and Shilpi Gupta<sup>2\*</sup>

<sup>1</sup>Research Scholar, Department of Economics, Manipal University Jaipur, Rajasthan-303007, India.

<sup>2</sup>Associate Professor, Department of Economics, Manipal University Jaipur, Rajasthan -303007, India.

Received: 07 Nov 2021

Revised: 14 Dec 2021

Accepted: 08 Jan 2022

### \*Address for Correspondence

#### Shilpi Gupta

Associate Professor,

Department of Economics,

Manipal University Jaipur, Rajasthan -303007, India.

Email: Shilpi.gupta@jaipur.manipal.edu



This is an Open Access Journal / article distributed under the terms of the **Creative Commons Attribution License** (CC BY-NC-ND 3.0) which permits unrestricted use, distribution, and reproduction in any medium, provided the original work is properly cited. All rights reserved.

### ABSTRACT

Rajasthan has about 11.27 per cent of livestock of the country which holds a large population of goat, cows, sheep, camels and buffalo. After Gujarat this state has led India's exemplary growth in dairy production by contributing around 12 per cent of milk production. More than 80 per cent of rural households are engaged in livestock farming eyeing greater opportunities of market access and the development of Rajasthan cooperative dairy federation, also the livestock production generate greater revenues as products are highly valued than regular crops. However, intensification of dairying has been accompanied with intensive use of water which is used for both growing feed and fodder for animals also for their drinking and cleaning purposes. On the other hand, Rajasthan is the most water stressed state in India, holding just 1.70 per cent of blue water and green water is certainly less with the least period of monsoon and climatic variability within the state. This study aimed to analyse that how dairying is a threat for the water and in future an obstacle on achieving SDG 2 with target of food security and 11 of responsibly production and consumption. This paper explained the economic water productivity in context of milk production in Rajasthan by quantifying green and blue water usage in livestock production. Increasing milk production in the state is overlooking the intensive water usage in production which is a scarce resource in Rajasthan. To quantify the total water used in milk production. To estimate economic water productivity of milk. The study is done with the collection of secondary data from the government annual reports of ministry of agriculture, cooperative dairy federation and primary data through random sampling for the case study and phone interviews of the 10 farmers of 10 different agro climatic district of Rajasthan. Data further analyzed by author's own created index. With the quantification of green and blue water usage in milk production, it is clear that white is a threat and this suggest strong need to reduce water intensity in milk production and virtual water trade. This study will raise the factor for further implementation of water policy and several related schemes.





Priya Modi and Shilpi Gupta

**Keywords:** Livestock productivity, economic water productivity, sustainable consumption, water stressed index, green and blue water footprint.

## INTRODUCTION

It has been more than 50 years of the advent of green revolution in India and since then trend of agriculture growth is inverted V shaped, that is in the initial years of revolution a significant level of growth in food grain production was seen with the usage of water intensive technologies but with the industrialization of Indian economy agriculture sector faced a downfall. This slump is responsible for creating water scarcity as more than 60 percent of freshwater is used in agriculture. Rajasthan is one of the few regions in the world where intensive use of groundwater for irrigation purposes had led to alarming levels of depletion of the same resource. This state is located in the western part of India and is majorly an arid region. Rajasthan is a major agrarian state of India, which contributes maximum in pulses production, wool production. The state also holds 10.41 percent of total livestock of India, out of this maximum number is of dairying animals. Dairy farming is highly water intensive in nature, and Rajasthan being the second largest producer of milk is a cause of concern as this state is one which has less per capita freshwater resource estimated to be less than 1100 cubic meter per annum which again varies in its different zones classified by Coppen, (O. P. Singh, 2015). The white revolution is turning out to be grey in Rajasthan's economy. Dairying not only includes the direct consumptive water use by animals for milk production but also hidden water or virtual water in fodder and by products of cereals and other residual which is fed to the cattle as roughage. But no study have so far attempted to quantify the amount of virtual water as a sum of blue and green water. The per capita water availability of freshwater resources in Rajasthan is estimated to be less than 1000 cubic meter. This paper aims to explain the economic water productivity in terms of milk production in Rajasthan by quantifying the blue and green water used in livestock production. This study explains blue water as the total runoff of water through taps, tanks or tube wells as irrigation and also drinking purposes of cattle and green water as the total rainwater used in feed and fodder cultivation.

As per CGWB 2011 ground water availability in Rajasthan is 11.91 billion cubic meter and out of this more than 90 percent of water is used up in irrigation if this continues in future we will be left with only 1 bcm(billion cubic meter) for irrigation uses(M. D. Kumar & Singh, 2005). The share of agriculture in (Growth State Development Product) GSDP is 29.45 percent at constant prices of 2011-12. Dairying contributes around 10.41 percent in GSDP. Dairy farmers heavily depend upon green fodder to feed the cattle, (M. Mekonnen et al., 2021; M. Mekonnen & Hoekstra, 2014; M. M. Mekonnen & Hoekstra, 2016), (M. Mekonnen & Hoekstra, 2014)is the embedded water. And growing trade of milk indicates export of virtual water from the state, (Chapagain & Hoekstra, 2008). Virtual water is the water used to produce a commodity or service, (Hoekstra et al., 2011), (O. P. Singh, 2015). This growing virtual water use in dairying for the livestock production is not just a regional issue but it has an impact at nation as well as global level, (V. Kumar & Jain, 2007). Alfalfa majorly known as lusan is the water guzzling crop which is part of green fodder, this crop is grown for yearlong which means that it does not reap off rainwater but as well as blue water(O. P. Singh & Singh, 2019). 3 litre water on an average is put in use to produce a litre of milk, (V. Singh & Rewani, 2018), (Ibidhi & Salem, 2018). A cattle animal needs around 20-25 litres of water per day just to drink, and that water which is consumed in production of feed and fodder is left out from evaluating the cost of production, rather only the electricity or water bill is accounted. In agriculture or any other sector water is used as an input but this is the cheapest despite its less availability and highest utility(Dinesh Kumar & Ballabh, n.d.). Economic quantification of water has not been taken up by dairy household or any study in Rajasthan. Government also has no accountability of green fodder which has heaviest water embedded in it, only dry fodder production is accounted again ignoring the value of water.

## OBJECTIVES AND METHODOLOGY

The objectives of this paper is to quantify the total irrigation water used in crop and dairy production in different regions of Rajasthan. And then further classifying water use in dairy production for cows and buffalo. To determine

38424





### Priya Modi and Shilpi Gupta

the irrigation water productivity of crop and dairy products in both agronomic and economic terms. To quantify the virtual water trade through trading milk outside the Rajasthan and also analyzing the potential impact of trade on groundwater draft and the distance from attaining the target of SDG 2.4 and 6.4. The study covered around 30 dairy farming households from different regions of Rajasthan. According to IRMA/UNICEF 2011, physical water scarcity index, more than half of the farmers included in the study were from water scarce region and rest were from water abundant region of Rajasthan. This study took into consideration both direct and indirect consumptive water use as an accumulative component of virtual water in order to estimate total water used for dairy animals and dairy production. Dairy Farmers engage in growing variety of crops to sustain dairy production and their livelihoods. In case of milk production, dairy farmers are required to feed the cattle. Most of the feed and fodder are byproducts of crops they grow at farms, for instance, they grow wheat for grains so grains are used up for domestic purpose and the wheat straw is used as the fodder for cattle. So in this case water used for growing wheat is proportionately used up in production of the fodder which is wheat straw in this case.

Dhondyal 1987 suggested by the agricultural department of Rajasthan, income generated from the crop is also shared in the same proportion that is for main and by-product. Now feed and fodder crops are also grown as per rabi and kharif seasons and in this study feed and fodder input is estimated for calves, milking animals and dry animals on an average. Not only feed and fodder depend upon seasons but also the lifecycle of an animal which consists calving, milking, dry stages of cattle including cows and buffaloes. Based on the primary study conducted for the study the estimates for daily feeding and drinking pattern of cattle is evaluated with the formulation mentioned below. Like a cow if gave birth to a calf in January month then she gives milk for like 7-8 months, if in January cow gives around 18-20 litres of milk per day then this can continue for next 60-80 days then every month it starts reducing so if a cow tend to conceive in April or May month then the dry stage of cow will be reduced down to four months as then if with the first calf's birth it stopped giving milk by September then from September then in January she will be ready to give another birth so only 4-5 months she would stay dry but in Rajasthan farmers tend to get cows conceived after September in an incentive of earning though milk production as they want to reap out whole benefits of the lactation period of cow. For buffalo it is more or less same. The total water used for milk production per day cattle requires drinking water and indirect component of water as in form of fodder and feed. Fodder crops are grown at the farm, which is particularly used up for green fodder and dry one. In cases if dairy farmer has no land then he or she end up buying from the market. Feed named *sagardaan* is also imported from outside the region if they are unaware the method of concentrate production at the farm. To quantify the water used in feed and fodder, total quantity of feed and fodder produced or bought from outside are considered.

The following formulation was considered to quantify the irrigation water productivity and Water use for crop production (Chapagain & Hoekstra, 2008; Novo & Garrido, 2008)

To quantify irrigation water use for crop production: Total water use(m<sup>3</sup>)= Area under crop production × Number of irrigation given to crop × hours per irrigation × pump discharge (m<sup>3</sup>/hour)

Water productivity for crop production

Crop water productivity= production (kg)/total water use(m<sup>3</sup>)

Total water use includes both drinking water and irrigation water used for both dry and green fodder production also the concentrate

Total water use (m<sup>3</sup>/animal) = drinking water (m<sup>3</sup>) + green fodder(m<sup>3</sup>) + dry fodder (m<sup>3</sup>) + concentrate (m<sup>3</sup>)

Milk production per (m<sup>3</sup>) of water= water productivity in milk production (litre/m<sup>3</sup>/animal) = milk production (litre/animal/day) / water use (m<sup>3</sup>/day/animal)

## FINDINGS AND DISCUSSION

The results of this research are related to the above mentioned formulation:



**Priya Modi and Shilpi Gupta****Water productivity of the crops grown for feed and fodder**

*Alfalfa/lusan/rijka*, is being used as a major component of green fodder for feeding the cattle for the milk production (Table 1). This is the most water intensive crop grown yearlong on an alternative basis with the other crop that is *kaanchni*. So farmers in the month of October sow alfalfa and till May it remain in the field as per the availability of water. In the overall period of its growth it requires irrigation every 5-6<sup>th</sup> day, in which irrigation is run for 6 hours which provides in total 1800 mm water for the entire crop season. This states that water productivity here is, one cubic meter water can produce 3-4 kg of alfalfa. Market value of alfalfa is Rs 4-5. Now 4-5 kg potatoes for instance take only 537 mm water, and the gross market value is about 15. Rabi crop such as wheat is used both as green and dry fodder, so to make it dry, field remain the same for four months while for green only two months produce is taken up in this also irrigation requirement is same and it is grown alternatively with millet by the farmers. This is greatly dependent upon the blue water for irrigation while the kharif crops as jowar, maize, barley are rain-fed, which means they depend upon the green water component.

**Feed and fodder used for milk production**

Average daily feed and fodder fed to the buffalo is 20-25kgs (dry + green + concentrate) (Table 2). Out of this, the share of green fodder is 50 percent, share of dry fodder is 20 percent and the concentrate holds around 30 percent. Average daily water for drinking requirement for buffalo is 25-30 litres. Among the dry fodder, crops are wheat husk or straw which holds 27 percent and bajra is 68 percent. In case of green fodder more than 70 percent is of alfalfa or kanchni and then the maize or juar or bajra as per the season. In case of concentrate, largest share is of sagardaan, which is the balanced cattle feed and lowest is the wheat flour. If a farmer doesn't buy concentrate and make on its own then they form it with wheat husk, cotton seed, mustard roughage, groundnut roughage, gram straw, sugarcane or jiggery and in winters grinded wheat or millet is used.(Table 2) For cow it is, 52 percent green fodder, 26 percent dry and 22 is the concentrate. Fodder ratio is more or less same as of the Buffalo but it just differs in the crossbred cows as they require largest share of concentrate. Drinking water requirement is around 22-28 litres per animal.

**Average daily milk production**

The average daily milk production was estimated as per the lifecycle of an animal. Average price offered by the dairy cooperatives to the farmers is Rs. 35-40 per litre for the cows, Rs. 52 per litre for the buffaloes. Cow gives around 18 litre of milk for 6 months on an average basis in year and gives birth to around 10-15 calves in its whole lifecycle if it is fed well with required nutrition quotients. Buffalo, on an average gives milk for 8 months after birth of calf. Both have their dry stages but buffalo has less dry months. Average milk production of buffalo is 10-15 litre per day per animal and of cows it is 6-7 litre per day.

**Agronomic efficiency of water use in milk production**

Average daily water use for buffalo for milk production is 10 cubic meter/animal (Table 2). It consists 4 cubic meter of green fodder, 2 cubic meter of dry fodder and 4 cubic meter of concentrate, there all are average based approximate figures according to the farmer's survey. The average daily buffalo milk production is 3 litres per cubic meter of water. The agronomic water efficiency for buffalo milk is 0.31 litres per cubic meter and the gross economic efficiency is Rs. 3.84 per cubic meter. On the other hand, the average daily use of water for milk production of crossbred cow is 10.51 cubic meter per animal. Total water used in production of 4.05 m<sup>3</sup>, 1.37 m<sup>3</sup>, 5.04 m<sup>3</sup>, 0.05 m<sup>3</sup>. Average milk production of crossbred cow is 5.11 litres per day. The agronomic efficiency of milk production from cow is 0.49 litres per cubic meter. The gross economic efficiency for the same is Rs 3.94 (Table 2).

**Impact of water efficient technology used in whole process of milk production**

Till now it is clear that water used for green fodder is in larger amount than it is used up in production of dry fodder, like alfalfa is grown yearlong so apart from rainwater it consumes blue water as well and rest other crops majorly depend upon that hidden component of water which is major component of virtual water (Table 1). According to Kumar et al.(2003), if technology like micro irrigation in which drip and sprinkler irrigation is practiced, if this used



**Priya Modi and Shilpi Gupta**

up in feed and fodder crop production then it not only save water by 43 percent but also increase the yield by 10 percent and also the nutrition component of the feed and fodder for the cattle. According to Singh et al 2013, if the concentrate is imported from other regions then it create higher virtual water trade, which is 32.52 percent per buffalo and 31.74 percent for cow, this is estimated on the basis of average daily water use for milk production.

**Gross and net water productivity for crop and milk production**

As mentioned above economic water efficiency is higher in case of vegetables as compared to the crops used in feed and fodder. But this is also the fact that it is less in the water guzzling crops like rice, cotton, soyabean. In case of food grains like bajra of kharif season, the economic water productivity is highest with Rs 7.73 and minimum of wheat with Rs 3.40 per cubic meter of water respectively (Table 3). In case of milk production, highest gross economic water productivity is of cow, as mentioned earlier. The net economic water productivity of milk production of (kharif) bajra and lowest of wheat crop. The net economic water productivity of milk production for cow is 0.17 per cubic meter and for buffalo is 0.19 per cubic meter of water (Table 3). The net economic return from milk production is very small yet the water use intensity is very high which is leading to virtual water scarcity in already stressed region like Rajasthan. Where farmers are increasingly engaging themselves in dairying. But farmers do not consider the virtual water, which they are feeding to cattle in form of feed and fodder and if they consider then effective net water productivity for cow and buffalo would be Rs 5.57 and Rs 5.22 respectively.

**CONCLUSION AND POLICY IMPLICATION**

This study shows that dairying is highly water intensive in nature economic activity which is not at all economical for the economy. Now given the fact that raj is the second largest producer of milk in India and farmers are heavily dependent on this farming practice. For this they get strong support from the government in form of subsidies on their bills, fertilizers, seeds, and animals but time has come when dairying has to be economically water efficient. Water saving technologies should be used in farming on an increasing pace, proper R & D should be undertaken by agricultural scientists on developing alternatives for water guzzling crop like alfalfa to feed the cattle with minimalistic water use. It would certainly enhance water productivity of milk, and yield of feed and fodder. Also crossbred cows are more economically efficient in terms of water as cleared from the study of Rajasthan so government and farmers should come up collectively ahead for the cow rearing.

**REFERENCES**

1. Chapagain, A. K., & Hoekstra, A. Y. (2008). The global component of freshwater demand and supply: An assessment of virtual water flows between nations as a result of trade in agricultural and industrial products. *Water International*, 33(1), 19–32. <https://doi.org/10.1080/02508060801927812>
2. Dinesh Kumar, M., & Ballabh, V. (n.d.). *WATER MANAGEMENT PROBLEMS AND CHALLENGES IN INDIA: AN ANALYTICAL REVIEW*. <http://irma.irm.ernet.in>
3. Hoekstra, A. Y., Chapagain, A. K., Aldaya, M. M., & Mekonnen, M. M. (2011). *The Water Footprint Assessment Manual*.
4. Ibidhi, R., & Salem, H. Ben. (2018). SC. *Small Ruminant Research*. <https://doi.org/10.1016/j.smallrumres.2018.06.003>
5. Kumar, M. D., & Singh, O. P. (2005). Virtual water in global food and water policy making: Is there a need for rethinking? *Water Resources Management*, 19(6), 759–789. <https://doi.org/10.1007/s11269-005-3278-0>
6. Kumar, V., & Jain, S. K. (2007). Status of virtual water trade from India. In *CURRENT SCIENCE* (Vol. 93, Issue 8). <http://www.waterfootprint.org/Reports/>
7. Mekonnen, M., & Hoekstra, A. Y. (2014). *Water footprint benchmarks for crop production : A first global assessment*. 46, 214–223. <https://doi.org/10.1016/j.ecolind.2014.06.013>
8. Mekonnen, M. M., & Hoekstra, A. Y. (2016). *A Global Assessment of the Water Footprint of Farm Animal Products*. 15(3), 401–415. <https://doi.org/10.1007/s10021-01>
9. Mekonnen, M., Neale, C. M. U., Ray, C., Erickson, G. E., & Hoekstra, A. Y. (2021). *Water productivity in meat and milk production in the US from 1960 to 2016*. 132(August 2019). <https://doi.org/10.1016/j.envint.2019.105084>







**Priya Modi and Shilpi Gupta**

10. Novo, P., & Garrido, A. (2008). Are virtual water " flows " in Spanish grain trade consistent with relative water scarcity ? *Ecological Economics*, 68(5), 1454–1464. <https://doi.org/10.1016/j.ecolecon.2008.10.013>
11. Singh, O. P. (2015). WATER PRODUCTIVITY OF MILK PRODUCTION IN NORTH GUJARAT , WESTERN INDIA WATER PRODUCTIVITY OF MILK PRODUCTION IN NORTH. *April*.
12. Singh, O. P., & Singh, P. K. (2019). Virtual irrigation water use in milk production : Results from water abundant regions of India. 8(4), 327–332.
13. Singh, V., & Rewani, S. K. (2018). Milk Production, Consumption and Disposal Pattern of Women Dairy Cooperative Society Members in Jaipur (Rajasthan). *September 2019*, 6–11. <https://doi.org/10.5455/ijlr.20180320065318>

**Table 1. Crop water use and Water productivity**

Name of the crop	Average depth of watering (mm)			Agronomic efficiency (kgs/m <sup>3</sup> )		Gross Economic Efficiency (Rs/ m <sup>3</sup> )			
	Main product	By-product	Total	Main product	By-product	Main product	By-product	Total	
<b>Green Fodder</b>									
1.	Jowar	721.21	-	721.21	2.43	-	3.65	-	3.65
2.	Rajka bajari	298.10	-	298.10	4.03	-	4.03	-	4.03
3.	Kharif jowar	647.72	-	647.72	1.97	-	1.97	-	1.97
4.	Alfalfa	1786.36	-	1786.36	3.41	-	5.12	-	5.12
5.	Jowar summer	832.79	-	832.79	1.32	-	1.32	-	1.32
<b>Cash crops</b>									
1.	Castor	1661.47	-	1661.47	0.69	-	10.17	-	3.94
2.	Cotton	645.40	-	645.40	0.21	-	3.94	-	3.94
3.	Tobacco	816.85	-	816.85	0.31	-	7.02	-	7.02
4.	Mustard	405.20	-	405.20	0.43	-	5.67	-	5.67
5.	Potato	537.12	-	537.12	4.50	-	12.13	-	12.13
<b>Foodgrain crops</b>									
1.	Bajari kharif	128.40	128.40	256.79	1.55	7.73	7.73	7.73	7.73
2.	Wheat	536.61	107.32	643.93	0.54	2.72	3.40	3.40	3.40
3.	Bajari summer	352.81	328.00	680.81	0.80	4.30	4.28	4.30	4.29

**Table 2. Average Feed and Fodder Use and Water Productivity for Milk Production**

Name of Feed and Fodder	Average Feed and Fodder Use (kgs/day/animal)		Average Daily Water Use (m <sup>3</sup> /animal)	
	Buffalo	CB Cow	Buffalo	CB Cow
Green Fodder	12.98	12.98	4.14	4.05
Dry Fodder	5.48	6.44	1.09	1.37
Concentrate	5.21	5.36	4.89	5.04
Drinking water (lts)	59.12	49.12	0.06	0.05
Total water used (m <sup>3</sup> )			10.17	10.51
Milk Production (litres/day)			3.12	5.11
Water productivity (Lts/day)			0.31	0.49



**Priya Modi and Shilpi Gupta****Table 3. Gross and Net Water Productivity**

Type of the crop	Name of the crop	Gross Economic Efficiency (Rs/m <sup>3</sup> )	Net Economic Efficiency (Rs/m <sup>3</sup> )
A. Cash Crops	Castor	10.17	7.21
	Cotton	3.94	0.68
	Tobacco	7.02	4.04
	Mustard	5.67	2.01
	Potato	12.13	2.98
B. Food grain Crops	Wheat	3.40	1.08
	Bajra	4.29	2.45
	Bajra (kharif)	7.73	4.82
C. Milk Production	Buffalo	3.84	0.19
	Crossbred Cow	3.94	0.17





## Health Literacy and Concerns among Nursing Staffs towards the COVID-19 Vaccination and the Associated Mucormycosis: A Quasi-Experimental Study

Amal I Khalil<sup>1,2</sup>, Hanaa A. Radwan<sup>3</sup>, Eman A. Shokr<sup>4</sup>, Mohamed E. Ahmed<sup>5</sup> and Amoura Soliman Behairy<sup>6</sup>

<sup>1</sup>Professor of Psychiatry and Mental Health Nursing, Faculty of Nursing, Menoufia University, Egypt.

<sup>2</sup>King Saud bin Abdelaziz University for Health Sciences, College of Nursing, Jeddah, Saudi Arabia

<sup>3</sup>Lecturer of Psychiatric and Mental health Nursing, Faculty of Nursing Menoufia University, Egypt.

<sup>4</sup>Lecturer of Family and Community Health Nursing Department, Faculty of Nursing Menoufia University, Egypt

<sup>5</sup>Assistant Professor of Biostatistics, College of Science and Health, Professions. KSAU-HS, University in Riyadh, Saudi Arabia.

<sup>6</sup>Medical-Surgical Nursing Department, Faculty of Nursing, Menoufia University, Egypt.

Received: 29 Oct 2021

Revised: 18 Dec 2021

Accepted: 06 Jan 2022

### \*Address for Correspondence

#### Amal I Khalil

Professor of Psychiatry and Mental Health Nursing,  
Faculty of Nursing,  
Menoufia University, Egypt.  
E.Mail: amalkhalil34@yahoo.com



This is an Open Access Journal / article distributed under the terms of the **Creative Commons Attribution License** (CC BY-NC-ND 3.0) which permits unrestricted use, distribution, and reproduction in any medium, provided the original work is properly cited. All rights reserved.

### ABSTRACT

Numerous vaccines have been approved in a lot of countries to combat the disease throughout the world. COVID-19 has led to a surge in cases of a potentially fatal fungal infection called Mucormycosis, broadly known as "black fungus. The purpose of this study was to investigate the effectiveness of a health literacy intervention on knowledge and concerns towards COVID-19 vaccine and associated black fungus. To achieve the aim of the current study, a quasi-experimental one-group (pre–posttest) design was utilized with 249 nursing faculties and students recruited conveniently from the faculty of nursing, Menoufia University, Egypt. Two tools were used first is demographic and personal characteristics and the second was assessing the participants' knowledge and concerns regarding the Covid-19 vaccine. Cronbach alpha coefficient was calculated for the tool dimensions and subscales, the values of Cronbach alpha coefficients were calculated at 0.71, 0.87, 0.93, and 0.83 for the dimensions of aspects of covid-19, motivated factors, concerns about the vaccine, and Mucormycosis issues respectively. Results showed a highly significant increase in nursing staffs' knowledge, beliefs, and attitudes post health literacy intervention concerning Covid 19 vaccinations, black fungi, attitudes, and practices at  $p < 0.001$ . Also, there was a noticed a highly significant decrease in the concerns towards COVID-19 vaccination post





**Amal I Khalil et al.,**

educational intervention It may, hence, be concluded that the literacy interventions had a great effect on the improvement in nursing staffs' knowledge, concerns and attitudes, toward Covid19 vaccinations and knowledge related associated black fungi post interventions at  $p < 0.001$ . Therefore, it is recommended to conduct further studies on different settings such as school teachers, factory workers to know their information, concerns, and attitude towards the Covid- 19 vaccination.

**Keywords:** knowledge, attitudes, COVID-19 vaccination, black fungi.

## INTRODUCTION

The COVID-19 outbreak has had a serious impact on human health, the community, and the economy (Biasio et al (2020). In 2019, the World Health Organization (WHO) labeled it a global health danger. Nurses are typically on the front lines of a pandemic, performing routine procedures with a high risk of infection. To avoid the transmission of infection, nurses must be protected from infection. The current covid-19 vaccination effort is regarded as the next critical step in the fight against the infection, and it appears to be effective in terms of viral protection and mortality rate reduction (Kwok, et al (2021). Vaccination decision-making is difficult and multifaceted. Vaccine misinformation generates both proponents and opponents of vaccination. Fake news concerning the Covid-19 vaccination has been widely disseminated on social media (Montagni, et al., (2021). Even though nurses have a professional obligation to get vaccinated to protect themselves as the largest group of health professionals on the frontline of health care systems, and that vaccination services are widely available, many nurses are concerned about vaccination programs (Montagni, et al., (2021) and (Chew et al., (2021). One of the top ten difficulties affecting global health systems is the delay or refusal of immunization (Chalmers, L. (2020). It has to do with one's personal views, motivation, information, and awareness (Barello et al., (2020). Identifying the factors or attitudes that make nursing staff hesitant to get vaccinated can aid in the development of health literacy and health education initiatives to raise vaccination uptake (MacDonald, (2015).

Health literacy is defined as "the personal traits and societal resources required for individuals and communities to access, understand, assess, and use information and services to make health decisions (Larson et al., (2014). For nurses' safety, they must get clear, succinct, and up-to-date information regarding vaccination programs and herd immunity, as well as information about another immediate threat, in the shape of coronavirus disease-associated Mucormycosis (Visscher et al., (2018). Mucormycosis is a fungal infection caused by a group of molds known as mucoromycetes. It's commonly referred to as "black fungus." Mucor mycosis has increased at a faster rate in the second wave of Covid-19 than in the first. It's more common in Covid-19 patients who have uncontrolled diabetes, spend a lot of time in critical care, and take a lot of corticosteroids. Monitoring and education are critical preventive methods to keep the frequency of Mucormycosis cases among Covid-19 patients from rising (Taylor et al., (2020).

According to current research, there are unfavorable attitudes, a lack of information, and overall discomfort across the immunization program's intervention areas, notably among the existing nursing staff and nursing students who will be future staff members. Because they are unprepared or unwilling to engage in vaccine discussions with hesitant patients and members of the general public. They play a critical role in educating and persuading people to get vaccinated (Raut & Huy, (2021).

### Significance of the study

Nurses play a critical role in addressing the Covid-19 health disaster both locally and globally. In Egypt, negative attitudes towards vaccines are a major source of health concerns. Obtaining population immunity to Covid-19 through vaccination is hampered by misinformation about vaccinations and, in particular, concerns about side effects. For patients and the broader public, nurses are a trustworthy and authoritative source of vaccine-related information. Nurses are a cornerstone for implementing WHO's a top priority of comprehensive health coverage, in



**Amal I Khalil et al.,**

addition to providing day-to-day care for patients. As well, they serve as a vital link between the patient and the rest of the health care team (Dybsand, Hall, & Carson (2019) and (Aldohyan et al.,(2019). Therefore, understanding the information, attitudes, and concerns that influence nurses' vaccination decisions and willingness are critical for successful pandemic control. The fundamental stage in assessing nursing staff's knowledge, attitudes, practices, and concerns about the Covid-19 vaccination is to assess their preparedness for vaccine health literacy and to address vaccine reluctance among them (Khalid et al., (2016). Several studies have highlighted that to increase vaccine acceptability, new policies and intervention measures to engage professional health professionals in health literacy programs are needed (Fernandez et al., (2020)and (Kaadan et al., (2021). As a result, the current research aimed to assess the effect of health literacy intervention on knowledge, attitude, practices, and concerns regarding the Covid-19 vaccine and coronavirus disease-associated Mucor mycosis among nursing staff

**Aim of the study**

The main aim of the current study was to investigate the effectiveness of health literacy intervention on knowledge and concerns towards the COVID-19 vaccine and associated black fungus. More specifically:

1. Assess participants' literacy related to covid vaccination and associated black fungi.
2. Explore participants' concerns related to covid 19 vaccination.
3. Examine the associations between literacy level and concerns among study participants
4. Examine the correlation between the participants' demographic background and their literacy level and concerns related to Covid 19 vaccination and associated black fungi

**Hypotheses****The study was tested the following hypotheses**

H1: Nursing staffs' health literacy score will be increased after the educational intervention.

H2: Nursing staff's concerns regarding the covid 19 vaccination and associated black fungi will be decreased post educational intervention.

H3: There will be a positive correlation between health literacy, and concerns among studied group basic demographic characteristics

**METHODS****Design**

To achieve the goals of this study, a web-based quantitative, quasi-experimental, one-group, pre-post test design was used. Tools of the study were transferred into google form as a pre-test and another form had the post-test. distribution was done through different social networks such as emails, Whatsapp, Messenger, and Facebook.

**Setting and subjects**

The study intervention was carried out at the Faculty of Nursing- Shebin Elkom city, Menoufyia University, Egypt. College of Nursing is an academic unit of Menoufia University and provides great opportunities for education and skills and the development of research and consultancy in a wide range of topics of professional and academic. The college offers Bachelor's, Master's, and Ph.D. degrees in 6 branches of Nursing Science. Data were collected by using a convenient sampling technique from 203 nursing students at senior levels plus 47 faculty members representing all departments of the Faculty of Nursing, Menoufia University. Data were collected during the spring semester of the academic year 2021-2022.

**Tools of the study**

The tool consisted of 2 main parts:

**Demographic and personal characteristics** form that enquires the participants about their age, marital status, residence, socioeconomic state, and if they have taken the Covid-19 vaccine or not





**Amal I Khalil et al.,**

### **knowledge and concerns regarding the Covid-19 vaccine and associated Mucormycosis Questionnaire**

This questionnaire was developed by the researchers of the current study based on an extensive literature review to assess the knowledge of the participants regarding covid vaccination, their concerns, and attitudes toward it. Therefore the questionnaires have consisted of 3 main parts as the following:

1<sup>st</sup> part: knowledge about covid vaccination: this consisted of 10 questions in two forms asked about is it mandatory to take the vaccine and how many doses are necessary to get the immunity against Covid19 and question asked about the eligible group for taking COVID-19 vaccine. In addition to 5 more questions were asked about different aspects of COVID-19 vaccination. The responses were measured on 4 –point Likert scale ranged from 0 (strongly disagree) to 4 (strongly agree). The higher the score, the higher the literacy the participants had.

2<sup>nd</sup> part asked the participants about concerns that might be responsible for their decision to take the vaccine. This part consisted of 6 statements rated on a Likert scale from strongly disagree (4) to strongly agree is (0) the statements all of reverse.

3<sup>rd</sup> part: practices after vaccination and black fungi: This was asked about the participants' practices after getting vaccinated and the rest asked about the black fungi information and the response of the participants was rate as correct (1) and incorrect (0) with higher score indicate the higher level of literacy about the associated complication with covid 19.

4<sup>th</sup> part: satisfaction with the program: it consisted of 3 questions which were used to ask the participants about their satisfaction rate with the program and their response was rated on a Likert scale from very satisfied (4) to very dissatisfied (0).

### **Validity and Reliability**

The research tools were reviewed by a jury of independent experts in the field of study for content validity and tested for internal reliability using the Cronbach alpha correlation coefficient. The questionnaires showed strong reliability after the pilot study which was collected from 10 participants to ensure the clarity of questionnaires and the needed time to fill it. Reliability was assessed by examining the internal consistency of pre-intervention responses. Cronbach alpha coefficient was calculated for the tool dimensions and subscales, the values of Cronbach alpha coefficients were calculated at 0.71, 0.87, 0.93, and 0.83 for the dimensions of aspects of covid-19, motivated factors, concerns about the vaccine, and Mucormycosis issues respectively. The results indicated a high level of internal consistency of pre-intervention responses.

### **Data collection procedure**

Data collection was implemented into 3 phases as follows:

#### **1st phase: program preparation and tool distribution**

This phase was concerned with searching the literature to prepare the content of the literacy intervention. The handout was revised by expert academic members, and sent via email to the participants to enhance their learning experiences. A group on WhatsApp was created to facilitate the dissemination of information, as well as college board, emails, and websites were used to announce the study. The google form of the pre-test was revised, reaching 203 students and 47 faculty staff members. Participants were contacted and a link on the ZOOM platform was developed and sent to all of them. Later, a meeting was held to explain the purpose of the study, the appropriate time for the next sessions, and the arrangement plan for conducting the program to avoid impacting their working hours, their schedule, and off days.

#### **2nd phase: program implementation and evaluation**

Once the proposed study was approved by the ethical committee of the Research Unit at College of Nursing, Menoufyia university, data collection was initiated after arranging with the dean of nursing college, Menofyia

38433





**Amal I Khalil et al.,**

University. It was confirmed that the participants of the Quasi-experimental group signed the consent form before starting the intervention, and filled the questionnaires before and after the intervention. The literacy intervention included 4 sessions, conducted over two weeks. The participants were divided into 4 subgroups, 75 each, and were contacted with the researchers of the current study in parallel sessions at the same time. The duration of the session ranged from 45 -60 minutes. It was conducted as follows.

Session No.	Title	Objectives	Content
S1	<b>Introduction about Covid 19 and immune system</b>	The objective of this session was to introduce an overview of the relationship between the immune system and Covid 19.	The content of the session covered the theoretical part of the immune system, mode of transmission of Covid19, early manifestations, and protection measures.
S2	<b>Covid 19 vaccination and necessary practices after vaccination with Covid19</b>	The objective of this session was to list different types of covid-19 vaccination, how it works, and the importance of vaccination in preventing infection and decreasing mortality rate	<ul style="list-style-type: none"> <li>• different types of covid-19 vaccination</li> <li>○ importance of vaccination in preventing infection and decreasing mortality rate.</li> <li>○ Necessary practices after vaccination</li> </ul>
S3	<b>Complications of Covid 19 and associated black fungi</b>	The objective of this session was to provide an overview of the complications of Covid19 and black fungi	The content of the session included an introduction about the black fungi, their causes, mode of transmission, and their relationship with Covid19. In addition to the preventive measures of covid 19 and black fungi.
S4	<b>Summary and program feedback</b>	This session's objective was to wrap up the contents of the program and answer the questions and concerns of the participants	They were motivated to take the Covid19 vaccine and in turn encourage others to take it as well. Finally, an evaluation was made to know the participant's feedback about the sessions and to ensure that the post-test questionnaire was filled and sent by all participants.

#### Methods of instructions

The lectures were interactively presented online to the participants, utilizing different instruction methods such as brainstorming, role play, PowerPoint, and videos to deliver the contents of the program.

#### Ethical Considerations

Approval to conduct the study was granted from the ethical committee of the Research Unit at College of Nursing, Menoufyia university. Informed written consent was obtained from all faculty members and students who agreed to participate in the study. Anonymity was ensured by using identification codes on the questionnaires that facilitated individual comparison between pre and post interventions.

#### Data Analysis and management

Data were collected, tabulated, statistically analyzed using an IBM personal computer with Statistical Package of Social Science (SPSS) version 25 (SPSS, Inc, Chicago, Illinois, USA). where the descriptive data were presented in the



**Amal I Khalil et al.,**

form of mean, standard deviation (SD), range, and qualitative data were presented in the form of numbers and percentages. To tests of significance Mc Nemar test, Wilcoxon test, Mann-Whitney test (nonparametric test, Kruskal Wallis (F) were used for comparison between three or more groups not normally distributed having quantitative variables. Spearman's correlation (r): is used for correlating two quantitative variables not normally distributed. A p-value of >0.05 was considered statistically non-significant. A p-value of <0.05 was considered statistically significant. A p-value of <0.001 was considered statistically highly significant.

## Results of the study

Table (1) The basic characteristics of participants were summarized in table 1, out of the 249 respondents, 197 were females, the mean age was 24 years with 4.5 SD. Most participants had a bachelor's degree. The vast majority working as nursing faculty. Participants from rural settings represented 73.9%, middle socioeconomic status was dominant among study participants. Only 8.8% of the individuals included in the study were had the covid-19 vaccine.

Table (2) Reflects that there was a highly significant increase in nursing staffs' knowledge post health literacy intervention than pre, where p-value <0.001. As only 23.2% of nursing staff are correctly answered in pre-assessment that knowledge as Pregnant ladies and lactating mothers is eligible to covid vaccination followed by 34.4% of nursing staff are correctly answered that Patients with Immunosuppressive patients are eligible to covid vaccination compared by 79.2%, 71.6 % in posttest respectively. The majority of nursing staffs (94.8%, 86.0% ,83.2% ,82.8% ,80.0%) respectively correctly answered in post-assessment that Adults  $\geq 18$  years, Persons having active COVID -19 infection, Patients with chronic diseases, Persons recovered from COVID -19 infection, and Persons allergic to food items /drugs are eligible to covid vaccination compared by (87.6%, 78.0%, 68.4%,56.4%,67.2%) in pretest respectively. Nearly equal numbers in pre (32.5%) and posttest (65.5) of participants correctly answered that Patients with black fungi infection are eligible to covid vaccination.

Table (3) shows that participants have a favorable attitude towards COVID-19 vaccination after the Health Literacy Program than preprogramming. The participants have significantly higher mean values of willingness to take the COVID-19 vaccine when they turn of vaccination comes, are willing to get the COVID-19 vaccine if they have to pay to get it, will recommend their family, friends, students, and patients to get vaccinated against COVID-19 respectively at p-value ( 0.001 ) after the Health Literacy Program compared by the pre-literacy program. There was a highly statistically significant high mean score of nursing staff beliefs towards COVID-19 vaccination after the Literacy Program compared by pretest at (p-value < 0.001).

Table (4) Reflects that there was a highly statistically significant reduction in all mean scores of nursing staff concerns towards COVID-19 vaccination post- Health Literacy Program compared to pre- Health Literacy Program where (p < 0.001). Figure (1) Reveals that there was a highly significant increase in nursing staffs' knowledge post health literacy intervention than pre, where p-value <0.001. The results showed that (80.7 %) of the participants were indicated the mandatory of taking the covid 19 vaccine in post-intervention -assessment compared by (65.5% ) in pre-intervention assessment. Figure (2) Illustrates that more than one-third (45.4%) of nursing staff strongly disagree about they don't need to follow preventive measures after getting the COVID-19 vaccine post-literacy program compared to 11.20 % of pre-literacy programs. Nearly equal number in pre (32%) and posttest (32.4) of participants nursing staffs disagree about don't need to follow preventive measures after getting COVID-19 vaccine. Figure (3) exhibited that the majority were between very satisfied and satisfied (48.6 and 44.6) respectively compared with only 0.4 % dissatisfied and 4.6 were neutral regarding the program. Table (5) shows that there were highly statistically significant improvements in participants' knowledge about black fungi after the Health literacy program than before the Health literacy program at p-value (0.001). Table (6) displays the highly significant correlation between main study scales including attitude, concern about COVID 19 vaccine and knowledge regarding black fungi and knowledge about who is eligible to covid vaccination at P-value =(0.002, 0.001, 0.001) respectively.





**Amal I Khalil et al.,**

Table (7) the mean score difference between pre and post-intervention was examined by the basic characteristics of respondents. A significant difference in the score difference was reported by educational level and having a covid-19 vaccine, the highest difference in score was found among post-doctorate individuals and those who did not have the vaccine. As it is reported that, there was a high statistically significant correlation between gender, educational level, attitude, concerns, and knowledge of black fungi at P-value = 0.002, 0.001 respectively. Also, there was a statistically significant relationship between gender and socioeconomic status and beliefs toward COVID 19 Vaccine at P-value = 0.002, 0.021 respectively.

## DISCUSSION

The Coronavirus Disease 2019 (COVID-19) disease caused severe disruptions and unique challenges for healthcare organizations worldwide. The COVID-19 pandemic had remarkable health, social, psychological, and economic impacts (Fegert, et al., 2020). Numerous vaccines have been approved in a lot of countries to combat coronavirus disease and spread throughout the world. COVID-19 has led to a surge in cases of a potentially fatal fungal infection called mucormycosis, broadly known as "black fungus." The infection is every bit dangerous and requires adequate attention and treatment (Marshoudi et al., 2021). The current study aimed to investigate the effectiveness of health literacy intervention on knowledge, and concerns towards COVID-19 vaccine and associated black fungus. Concerning participants opinion of legally mandatory to taking COVID-19 vaccine, the current study results showed that more than half of them (65.46%) were agreed about legally mandatory to taking COVID-19 vaccine, and about a third of them (34.54%) did not agree about legally mandatory of taking COVID-19 vaccine, and this is in line with a study by Marshoudi et al., 2021 about COVID-19 vaccine literacy in Milan, Italy. The latter study concluded that about two-thirds of nursing staff (66%) were agreed to the legally mandatory of taking the COVID-19 vaccine and about a third of them (34%) did not agree about legally mandatory to taking COVID-19 vaccine.

Furthermore, the study conducted by (Elhadi et al., 2021) about knowledge, attitude, and acceptance of healthcare workers regarding the COVID-19 vaccine in Libya, concluded that about two-thirds of participants (71.6%) agree about legally mandatory of taking the COVID-19 vaccine. On the contrary, Biasio et al., 2020 contradicted these results and concluded that in Italy, most participants (86%) were not agreed about the legally mandatory of taking the COVID-19 vaccine. From the researchers' point of view, vaccination against COVID-19, in addition to precautionary measures, has become the weapon against the spread of infection, therefore most countries have imposed compulsory vaccination to control the spread of infection. Thus, the COVID-19 vaccine is now a globally emerged goal in an attempt to control the infection. Concerning attitudes and beliefs towards COVID-19 vaccination pre and post the health literacy intervention, the current study illustrated that there was the nursing staff has significant higher mean values of willing to take the COVID-19 vaccine when they turn of vaccination comes, willing to get the COVID-19 vaccine if they have to pay to get it, will recommend their family, friends, students, and patients to get vaccinated against COVID-19 respectively at p-value ( 0.001 ) after the health literacy intervention compared by the pre-literacy program. There was a highly statistically significant high mean score of nursing staff beliefs towards COVID-19 vaccination after the literacy program compared by pretest at (p-value < 0.001). These results lead to acceptance of the first study hypothesis "Nursing staffs health literacy score will be increased after the educational intervention". In congruence with the current study (Ahmed et al., 2021) who concluded that there was a highly significant increase in nursing staff's knowledge concerning who is eligible to COVID-19 vaccination post educational intervention, which (p < 0.005).

These results agree with the results of (Jiang et al., 2021) about nursing students' attitudes, knowledge, and willingness to receive the coronavirus disease vaccine in China and reported that there was a highly significant increase in nursing staff's knowledge concerning who is eligible to COVID-19 vaccination, which (p < 0.001) post educational intervention than pre. On the contrary, Ciardi et al., 2021 contradicted these results and concluded that even though there is an excellent intervention in their study, there was no significant difference in nursing staffs' knowledge post educational intervention than pre-intervention, regarding who is eligible for COVID-19 vaccination.



**Amal I Khalil et al.,**

The differences in the current study might be related to the difference in the time of data collection and the change of the participants. Also, maybe related to nursing staffs' knowledge couldn't be improved only by educational intervention but requires more structural planning and program. Concerning nursing staffs' knowledge, attitudes, and beliefs towards COVID-19 vaccination pre and post-educational intervention, the current study showed improvement in nursing staffs' knowledge, beliefs, and attitudes, which significantly increased post educational intervention ( $p < 0.001$ ). These results lead to acceptance of the first study hypothesis "Nursing staffs health literacy score will be increased after the educational intervention". In the same line were Ahmed et al, 2021 who concluded that more than half of the respondents had high knowledge towards COVID-19 vaccine post educational intervention ( $p < 0.001$ ). Additionally, 95.6% of respondents had a favorable attitude towards the COVID-19 vaccine.

In addition, Jiang et al. 2021 concluded that in China, the score rates of the attitude, beliefs, and knowledge towards COVID-19 vaccine were significantly increased post-intervention were 70.07%, 80.70%, and 84.38%, respectively. The attitude was significantly improved post-intervention, which ( $p < 0.001$ ). On the contrary, Biasio et al., 2020 contradicted these results and concluded that non-significant difference in nursing staffs' knowledge, beliefs, and attitudes after the educational intervention. From the researchers' point of view, nursing staff who had sufficient knowledge about the disease, its symptoms, modes of transmission and complication of disease as death, they weight between benefits and side effect of COVID-19 vaccination and complication of the disease, therefore were more intent to be vaccinated against COVID-19. Also, nursing staff reported that they would take a vaccine if it were proven to be safe and effective, Therefore, in the current study through effective educational intervention given to the nursing staff' their knowledge, attitudes, and beliefs towards COVID-19 vaccination significantly increased. Comparing with the previous studies there was not enough information about vaccination, so the knowledge, attitudes, and beliefs towards COVID-19 vaccination did not improve.

Concerning concerns of nursing staffs towards COVID-19 vaccination, the current study results showed a highly significant decrease in the concerns towards COVID-19 vaccination post educational intervention than pre ( $p < 0.001$ ). These results lead to acceptance of the second study hypothesis "There will be a correlation between health literacy, and concerns among the studied group ", and this is in line with a study by Tahir et al. 2021 about fear of COVID-19 vaccines in the Iraqi Kurdistan region. The latter study concluded that the majority of participants had a medium level of fear had significantly decreased post educational intervention ( $p$ -value = 0.016), the main reasons for fears were fear of side effects such as coagulopathy and other complication of vaccines. In congruence with the current study was Szmyd et al., 2020, who concluded that a highly statistically significant decrease in the concerns towards COVID-19 vaccination post educational intervention and participants were willing to get vaccinated against the SARS-CoV-2 as compared to the control group (82.95% vs. 54.31%, respectively). Furthermore, El-Elimat et al., 2021, concluded that the majority of the study's sample had concerns about vaccine safety, efficacy, and potential side effects as top reasons for COVID-19 vaccination hesitancy in healthcare workers, and these concerns a statistically significant decreased post educational intervention.

On other hand, Biswas et al., 2021 contradicted these results and concluded that the majority of the studies found concerns about vaccine safety, efficacy, and potential side effects as top reasons for COVID-19 vaccination hesitancy in healthcare workers, with a non-significant difference in nursing staff concerns after the educational intervention. Most of the participants found concerns about vaccine safety, efficacy, and potential side effects as top reasons for COVID-19 vaccination hesitancy in healthcare workers. The differences in the current study might be related to nursing staff health concerns (side effects, infertility), and the culture of the Egyptian community toward vaccination due to misinformation from social media and peer interaction. But because of what participants saw of the increase in the number of cases globally and locally and the increase in the death rate according to the report of the World Health Organization, and because of effective educational intervention beside the role of the Ministry of Health and Population in Egypt initiated a public awareness to a population in addition, to the nursing staffs show the friends and other family members taken vaccine had less side effect which turn in decrease concerns toward vaccination.



**Amal I Khalil et al.,**

Regarding the comparison of nursing staff's knowledge regarding black fungi pre and post the health literacy intervention. The current study showed that knowledge scores of nursing staff about black fungi were low and showed significant improvement after educational intervention ( $p < 0.001$ ). These results lead to acceptance of the third study hypothesis "Nursing staffs concerns regarding the COVID-19 vaccination and associated black fungi will be decreased post educational intervention ". In congruence with the current study was Hasan et al.2021, who concluded that increased knowledge score about black fungus after educational intervention ( $p < 0.001$ ), the average score of black fungus fear was significantly increased association between black fungus fear score and knowledge score of black fungus and other determinants of nursing staffs. Similarly, Kabir et al. 2021, found that the black fungus knowledge mean scores of nursing staff were significantly improved after the educational intervention. A systemic review conducted by Divakar, 2021 about fungal taxa responsible for black fungus" among COVID-19 patients in India, concluded that the effective educational intervention positively increased nursing staff's knowledge about black fungus. The appearance of the black fungus is not new, but with its appearance with COVID-19, fears, and knowledge about its increase. This may explain the observed higher score of nursing knowledge after educational intervention as health literacy score increased after the educational intervention.

Regarding the relation between knowledge regarding who is eligible to covid vaccination, attitude, concern, and socio-demographic data of the studied groups, the current study results indicated that there was a highly statistically significant relationship between gender, educational level, and attitude at P-value = 0.002, 0.001 respectively. Also, there was a highly statistically significant relationship between educational level and concern toward COVID-19 Vaccine at P-value = 0.001. Also, the table displays that there was a highly statistically significant relationship between educational level and both Beliefs toward COVID 19 Vaccines, knowledge regarding black fungi at P-value = 0.001. This result was consistent with the result obtained by Ciardi et al., 2021, who investigated knowledge, attitudes, and perceptions of COVID-19 vaccination among healthcare workers, they showed that several factors were significantly associated with vaccine attitudes, including demographics such as gender ( $p = 0.002$ ), age ( $p = 0.005$ ), race ( $p < 0.001$ ) and home location ( $p < 0.001$ ), and confidence in and expectations about personal protective equipment and behaviors ( $p < 0.001$ ).

Furthermore, Jiang et al. 2021 added that a highly significant correlation between socio-demographic characteristics and attitude, knowledge, and concerns towards COVID-19 vaccine, where p-value 0.001, includes age, working experience, marital status, risk degree, and gender. From the researchers' point of view, this might be related to nursing is traditionally a female-dominated profession and male students who are a minority group in nursing. In addition, the highly educated nursing staff had a highly significant relationship between socio-demographic characteristics and attitude, knowledge, and concerns towards COVID-19 vaccine, because the higher education rate, the more information they have and their behavior changes for the better.

## CONCLUSION AND RECOMMENDATIONS

Up to the researchers' knowledge, this study is one of the fewest studies that tested the applicability and effectiveness of health literacy and concerns among nursing staff towards the COVID-19 vaccination and the associated black fungus, especially at the nursing staff, in contributing to the improvement in knowledge and decrease concerns towards COVID-19 vaccine and associated black fungus. The use of convenience sampling technique in addition to the small sample of clients included may limit the generalization of results. Further research is still needed to analyze the middle and later stages of willingness to be vaccinated as well as the actual vaccination behavior. Based on the results of the current study, it can be concluded that the current study showed improvement in nursing staffs' knowledge, beliefs, and attitudes, which significantly increased post educational intervention. There was also a noticed a highly significant decrease in the concerns towards COVID-19 vaccination post educational intervention. Furthermore, there were knowledge scores of nursing staff about black fungi were low and showed significant improvement after the educational intervention.





**Amal I Khalil et al.,**

### Implications for nursing practice and management

Great attention to improved students' knowledge of the COVID-19 vaccine. Construct program to encourage peer influence in the acceptance of vaccination against COVID-19. Design appropriate strategic management plans to enhance the quality of awareness to accept the vaccines. Should strengthen education on the adverse reactions of COVID-19 vaccine; it should not only include the provision of theoretical knowledge but also discuss the actual psychological and physiological effects of the vaccine, so that students can have an objective understanding of the side effects of the vaccine, thus eliminating fear and enhancing the willingness to be vaccinated. Misinformation is promulgated through social media as well as by peer groups, including family and friends. Should carry out training programs for Nurses' staffs. Those responsible for nursing education (in faculties of nursing) should engage Covid-19 vaccination into nursing curricula. Further longitudinal research studies should be carried out to assess other side effects and cultural factors that significantly affect Covid-19 vaccination hesitancy. Further studies on different settings to be conducted such as schools, factories, other colleges, and institutions all over the Arab Republic of Egypt to increase the awareness about the importance of Covid19 vaccination in decreasing infections and mortality among the population.

### CONFLICT OF INTERESTS

The authors declare that there is no conflict of interests

### ACKNOWLEDGMENTS

The authors of the study want to thanks all participants of the current study for their time effort, and positive response to participate in the completion of this study

### REFERENCES

1. Biasio, LR, Bonaccorsi, G., Lorini, C, and Pecorelli, S. (2020). Assessing COVID-19 vaccine literacy: a preliminary online survey. *Human Vaccines & Immunotherapeutic*; 1-9. <https://doi.org/10.1080/21645515.2020.1829315>
2. Kwok, et al., (2021) Influenza vaccine uptake, COVID-19 vaccination intention and vaccine hesitancy among nurses: a survey. *International journal of nursing studies.*; 14 (103854). <https://doi.org/10.1016/j.ijnurstu.2020.103854>
3. Montagni, et al., (2021) Acceptance of a Covid-19 vaccine is associated with the ability to detect fake news and health literacy. *Journal of public health.*; pp. 1–8 | <https://doi:10.1093/pubmed/fdab028>
4. Chalmers, L. (2020). Responding to the state of the world's nursing 2020 report in Aotearoa New Zealand: Aligning our nursing workforce to universal health coverage and health equity. *Nursing Praxis in Aotearoa New Zealand*, 36(2), 7-19. <https://doi.org/10.36951/27034542.2020.007>
5. Barelllo, S., Nania, T., Dellafiore, F., Graffigna, G., & Caruso, R. (2020). 'Vaccine hesitancy among university students in Italy during the COVID-19 pandemic. *European Journal of Epidemiology*, 35(8), 781-783. <https://doi.org/10.1007/s10654-020-00670-z>
6. MacDonald, N.E. (2015). Vaccine hesitancy: Definition, scope, and determinants. *Vaccine*, 33(34), 4161-4164. <https://doi.org/10.1016/j.vaccine.2015.04.036>
7. Larson, H. J., Jarrett, C., Eckersberger, E., Smith, D. M., & Paterson, P. (2014). Understanding vaccine hesitancy around vaccines and vaccination from a global perspective: A systematic review of published literature, 2007–2012. *Vaccine*, 32(19), 2150-2159. <https://doi.org/10.1016/j.vaccine.2014.01.081>
8. Visscher, B. B., Steunenberg, B., Heijmans, M., Hofstede, J. M., Devillé, W., Van der Heide, I., & Rademakers, J. (2018). Evidence on the effectiveness of health literacy interventions in the EU: A systematic review. *BMC Public Health*, 18(1). <https://doi.org/10.1186/s12889-018-6331-7>
9. Taylor, S., Landry, C. A., Paluszek, M. M., Groenewoud, R., Rachor, G. S., & Asmundson, G. J. (2020). A proactive approach for managing COVID-19: The importance of understanding the motivational roots of vaccination hesitancy for SARS-cov2. *Frontiers in Psychology*, 11. <https://doi.org/10.3389/fpsyg.2020.575950>





**Amal I Khalil et al.,**

10. Raut, A., & Huy, N. T. (2021). Rising incidence of mucormycosis in patients with COVID-19: Another challenge for India amidst the second wave? *The Lancet Respiratory Medicine*, 9(8), e77. [https://doi.org/10.1016/s2213-2600\(21\)00265-4](https://doi.org/10.1016/s2213-2600(21)00265-4)
11. Dybsand, L. L., Hall, K. J., & Carson, P. J. (2019). Immunization attitudes, opinions, and knowledge of healthcare professional students at two midwestern universities in the United States. *BMC Medical Education*, 19(1). <https://doi.org/10.1186/s12909-019-1678-8>
12. Aldohyan, M., Al-Rawashdeh, N., Sakr, F. M., Rahman, S., Alfarhan, A. I., & Salam, M. (2019). The perceived effectiveness of MERS-Cov educational programs and knowledge transfer among primary healthcare workers: A cross-sectional survey. *BMC Infectious Diseases*, 19(1). <https://doi.org/10.1186/s12879-019-3898-2>
13. Khalid, I., Khalid, T. J., Qabajah, M. R., Barnard, A. G., & Qushmaq, I. A. (2016). Healthcare worker's emotions, perceived stressors, and coping strategies during a MERS-Cov outbreak. *Clinical Medicine & Research*, 14(1), 7-14. <https://doi.org/10.3121/cmr.2016.1303>
14. Fernandez, R., Lord, H., Halcomb, E., Moxham, L., Middleton, R., Alananzeh, I., & Ellwood, L. (2020). Implications for COVID-19: A systematic review of nurses' experiences of working in acute care hospital settings during a respiratory pandemic. *International Journal of Nursing Studies*, 111, 103637. <https://doi.org/10.1016/j.ijnurstu.2020.103637>
15. Chew, N. W., Cheong, C., Kong, G., Phua, K., Ngiam, J. N., Tan, B. Y., Wang, B., Hao, F., Tan, W., Han, X., Tran, B. X., Hoang, M. T., Pham, H. Q., Vu, G. T., Chen, Y., Danuaji, R., RN, K., PV, M., Talati, K., ... Sharma, V. K. (2021). An Asia-Pacific study on healthcare workers' perceptions of, and willingness to receive, the COVID-19 vaccination. *International Journal of Infectious Diseases*, 106, 52-60. <https://doi.org/10.1016/j.ijid.2021.03.069>
16. Kaadan, M. I., Abdulkarim, J., Chaar, M., Zayegh, O., & Keblawi, M. A. (2021). Determinants of COVID-19 vaccine acceptance in the Arab World: A cross-sectional study. *Global Health Research and Policy*, 6(1). <https://doi.org/10.1186/s41256-021-00202-6>
17. Fegert J, Vitiello B, Plener P, and Clemens V. (2020). Challenges and burden of the Coronavirus 2019 (COVID-19) pandemic for child and adolescent mental health: a narrative review to highlight clinical and research needs in the acute phase and the long return to normality. *Child Adolesc Psychiatry Ment Health*. 14:20 <https://doi.org/10.1186/s13034-020-00329-3>.
18. Marshoudi S, Al-Balushi H, Al-Wahaibi A, Al-Khalili A, Al-Maani A, Al-Farsi A, Al-Habsi Z, Al-Shaibi M, Al-Msharfi M, Al-Ismaili A, and Al-Buloshi H. (2021). Attitudes, and Practices (KAP) toward the COVID-19 Vaccine in Oman: A Pre-Campaign Cross-Sectional Study. *Vaccines*, 9, 602. <https://doi.org/10.3390/vaccines9060602>.
19. Elhadi M, Alsoufi A, Alhadi A, Hmeida A, Alshareea E, Dokali M, Abodabos S, Alsadiq O, Mohammed A, Ashini A, Shaban A, Mohammed S, Alghudban N, Bureziza E, and Najah Q. (2021). Knowledge, attitude, and acceptance of healthcare workers and the public regarding the COVID-19 vaccine: a cross-sectional study. *BMC Public Health* (2021) 21:955 <https://doi.org/10.1186/s12889-021-10987-3>
20. Biasio L, Bonaccorsi G, Lorini C & Pecorelli S. (2021). Assessing COVID-19 vaccine literacy: a preliminary online survey. *Human Vaccines & Immunotherapeutics*, 17:5, 1304-1312. <https://doi.org/10.1080/21645515.2020.1829315>.
21. Ahmed M, Siraj S, Klein J, Yassin F, Shuma A, and Kanfe G. (2021). Knowledge and Attitude Towards Second COVID-19 Vaccine Dose Among Health Professionals Working at Public Health Facilities in a Low-Income Country. *Infection and Drug Resistance* 2021:14 <https://www.dovepress.com/knowledge-and-attitude-towards-second-covid-19-vaccine-dose-among-heal-peer-reviewed-fulltext-article-IDR>.
22. Jiang N, Wei B, Lin H, Wang H, Chai S, and Liu W. (2021). Nursing students' attitudes, knowledge, and willingness to receive the coronavirus disease vaccine: A cross-sectional study. *Nurse Education in Practice* 55 (2021) 103148. <https://www.sciencedirect.com/science/article/pii/S1471595321001840?via%3>
23. Ciardi F, Menon V, Jamie L, Shariff M, and Pii A. (2021). Knowledge, Attitudes, and Perceptions of COVID-19 Vaccination among Healthcare Workers of an Inner-City Hospital in New York. *on Vaccines* 2021, 9, 516. <https://www.mdpi.com/journal/vaccine>.
24. Tahir A, Ramadhan D, Taha A, Abdullah R, Karim S, Ahmed A and Ahmed A. (2021). Public fear of COVID-19 vaccines in Iraqi Kurdistan region: a cross-sectional study. 28:46 Page 2 of 8 <https://mecp.springeropen.com/track/pdf/10.1186/s43045-021-00126-4.pdf>





**Amal I Khalil et al.,**

25. Szmyd B, Karuga F, Bartoszek A, Staniecka K, Natalia S, Agnieszka B, Błaszczuk M and Radek M. (2021). Attitude and Behaviors towards SARS-CoV-2 Vaccination among Healthcare Workers: A Cross-Sectional Study from Poland. *Vaccines*, 9, 218. <https://doi.org/10.3390/vaccines9030218>
26. Biswas N, Mustapha T, and Khubchandani J. (2021). The Nature and Extent of COVID-19 Vaccination Hesitancy in Healthcare Workers. *J Community Health*. 2021 Apr 20: 1–8. DOI: 10.1007/s10900-021-00984-3
27. Hasan K, Kabir H, Rahman M, Roy K, and Mitra D. (2021). Predictors of black fungus fear during the COVID-19 pandemic among the Bangladeshi health workers: a cross-sectional study. 12, 29. <https://doi.org/10.1101/2021.07.03.21259961>.
28. Kabir H, Hasan K, Rahman A, Akter S, Chowdhury G, Rahaman M, and Mitra D. (2021). Black fungus or mucormycosis: a cross-sectional knowledge assessment among the Bangladeshi health care workers during COVID-19 pandemic. <https://doi.org/10.31234/osf.io/dkzqx>
29. Biswas N, Mustapha T, Jagdish K, and James P. (2021). The Nature and Extent of COVID-19 Vaccination Hesitancy in Healthcare Workers. *Community Health*. 20: 1–8. DOI: 10.1007/s10900-021-00984-3
30. El-Elimat T, AbuAISamen M, Almomani B, Al-Sawalha N and Alali F. (2021). Acceptance and attitudes toward COVID-19 vaccines: A cross-sectional study from Jordan. *PLoS ONE* 16(4): e0250555. <https://doi.org/10.1371/journal.pone.0250555>.

**Table (1): Distribution of sociodemographic characteristics of the studied sample**

Studied variables	Studied group (N=249)	
	No.	%
<b>Age / years</b>		
Mean ±SD	24.0±4.48	
Range	21.0 – 47.0	
<b>Gender</b>		
Male	52	20.8
Female	198	79.2
<b>Residence</b>		
Rural	185	74.0
Urban	65	26.0
<b>Educational level</b>		
Bachelors	202	80.8
Masters	19	7.60
PhD	27	10.8
Post-doctorate	2	0.80
<b>Place of work</b>		
Hospital	20	8.00
Nursing faculty	230	92.0
<b>Socioeconomic status</b>		
Low	5	2.00
Middle	240	96.0
High	5	2.00





Amal I Khalil et al.,

Table (2): Comparison of nursing staffs knowledge regarding who is eligible to covid vaccination pre and post the Health Literacy Program (N=249).

Studied variables	Pre-program		Post-program		Mc Nemar test	P-value
	Correct answer N(%)	Incorrect answer N(%)	Correct answer N(%)	Incorrect answer N(%)		
Infant <1 year of age	237(94.8)	13(5.20)	240	10	0.41	0.521
Children and adolescents < 18 years of age	68(27.2)	182(72.8)	86(34.4)	164(65.6)	3.21	0.073
Adults ≥18 years	219(87.6)	31(12.4)	237(94.8)	13(5.20)	8.50	<b>0.004**</b>
Pregnant ladies and lactating mothers	58(23.2)	192(76.8)	198(79.2)	52(20.8)	12.3	<b>0.001**</b>
Patients with chronic diseases like diabetes, hypertension, and heart diseases	171(68.4)	79(31.6)	208(83.2)	42(16.8)	22.7	<b>0.001**</b>
Persons having active COVID -19 infection	195(78.0)	55(22.0)	215(86.0)	35(14.0)	5.82	<b>0.016*</b>
Persons recovered from COVID -19 infection	141(56.4)	109(43.6)	207(82.8)	43(17.2)	45.9	<b>0.001**</b>
Persons allergic to food items /drugs	168(67.2)	82(32.8)	200(80.0)	50(20.0)	11.7	<b>0.001**</b>
Immunosuppressive patients	86(34.4)	164(65.6)	179(71.6)	71(28.4)	68.8	<b>0.001**</b>
Patients with a black fungi infection	82(32.8)	168(67.2)	163(65.2)	87(34.8)	51.2	<b>0.001**</b>

\*\*High significant

Table (3) Comparison of nursing staffs attitudes and beliefs towards COVID-19 vaccination pre and post the Health Literacy Program (N=249)

Studied variables	Pre-program	Post-program	Wilcoxon test	P-value
	Mean ±SD	Mean ±SD		
When my turn of vaccination comes, I am willing to take the COVID-19 vaccine	0.86±0.78	1.51±0.96	8.80	<b>0.001**</b>
I will prefer to acquire immunity against COVID-19 naturally (by having the disease/subclinical infection) rather than by vaccination	1.99±0.97	2.04±1.24	0.416	0.678
I am willing to get the COVID-19 vaccine if I have to pay to get it.	1.46±0.93	1.80±0.94	5.09	<b>0.001**</b>
I will recommend my family and friends get vaccinated against COVID-19	0.80±0.68	1.46±0.99	8.65	<b>0.001**</b>
I will recommend my students and patients get vaccinated against COVID-19	0.81±0.69	1.44±0.98	8.47	<b>0.001**</b>
Total Attitude	6.00±2.96	8.21±3.70	8.48	0.001**
<b>beliefs towards COVID-19 vaccination</b>				





**Amal I Khalil et al.,**

I think there is no harm in taking the COVID-19 vaccine	0.99±0.86	1.63±0.99	7.76	<b>0.001**</b>
I believe the COVID-19 vaccine will be useful in protecting me from the COVID-19 infection	0.78±0.71	1.38±1.00	7.82	<b>0.001**</b>
I believe that the COVID-19 vaccine is available free cost	0.63±0.67	1.11±0.93	7.01	<b>0.001**</b>
I believe that expertise and investigations in the health field recommended me	0.94±0.81	1.28±0.92	4.95	<b>0.001**</b>
I believe that the benefits of taking the COVID-19 vaccine outweigh the risks involved	0.90±0.78	1.51±0.95	7.73	<b>0.001**</b>
I believe that taking the COVID-19 vaccine is a societal responsibility	0.93±0.76	1.37±0.93	6.47	<b>0.001**</b>
I believe that there is sufficient data regarding the vaccine's safety and efficacy released by the government	0.88±0.74	1.53±0.97	8.60	<b>0.001**</b>
I believe many people are taking the COVID-19 vaccine	0.82±0.71	1.32±0.90	7.37	<b>0.001**</b>
I think it will help in eradicating COVID-19 infection	0.86±0.76	1.44±0.85	7.51	<b>0.001**</b>
<b>Total Beliefs</b>	<b>7.76±5.22</b>	<b>12.6±7.03</b>	<b>8.80</b>	<b>0.001**</b>

\*\*High significant

**Table (4) Comparison of nursing staffs concerns toward the COVID-19 vaccine pre and post the Health Literacy Program (N=249)**

Studied Items	Pre-program	Post-program	Wilcoxon test	P-value
	Mean ±SD	Mean ±SD		
COVID-19 vaccine might not be easily available to me	2.16±0.98	1.65±1.02	6.42	<b>0.001**</b>
Might have immediate serious side effects after taking COVID-19	1.95±1.00	1.17±0.96	8.38	<b>0.001**</b>
COVID-19 may be fault or fake	2.16±0.98	1.50±1.08	7.58	<b>0.001**</b>
COVID-19 was rapidly developed and approved	2.22±0.99	1.53±1.07	7.60	<b>0.001**</b>
I might have some unforeseen future effects of the COVID-19 vaccine	2.01±1.01	1.22±1.02	8.41	<b>0.001**</b>
COVID-19 is being promoted for commercial gains of pharmaceutical companies	2.03±1.00	1.48±1.12	6.10	<b>0.001**</b>
<b>Total concern</b>	<b>12.5±4.91</b>	<b>8.57±5.24</b>	<b>8.79</b>	<b>0.001**</b>

\*\*High significant







Amal I Khalil et al.,

**Table (5) Comparison of Nursing staff' knowledge regarding black fungi Pre and Post the Health Literacy Program . (N=249)**

Studied variables	Pre-program		Post-program		Mc Nemar test	P-value
	Correct answer N (%)	Incorrect answer N(%)	Correct answer N(%)	Incorrect answer N(%)		
What are black fungi	126(50.4)	124(49.6)	215(86.0)	35(14.0)	73.7	0.001**
How do you get it	60(24.0)	190(76.0)	197(78.8)	53(21.2)	113.4	0.001**
Is there is a link between COVID-19 and black fungi infection	151(60.4)	99(30.6)	192(76.8)	58(23.2)	23.2	0.001**
If yes, do you think that it is a complication of COVID-19	123(49.2)	127(50.8)	167(66.8)	83(33.2)	24.3	0.001**
The black fungi infection has existed since and before the emergence of the Coronavirus?	129(51.6)	121(48.4)	177(70.8)	73(29.2)	29.1	0.001**
What are the reasons for increasing black fungi with the crisis of COVID-19	170(68.0)	80(32.0)	223(89.2)	27(10.8)	41.6	0.001**
Is there early symptoms of a black fungi infection	90(36.0)	160(64.0)	206(82.4)	44(17.6)	108.4	0.001**
If the answer is yes, mention only three of them	108(43.2)	142(56.8)	213(85.2)	37(14.8)	106.1	0.001**
List three ways to prevent black fungi infection	157(62.8)	93(37.2)	215(86.0)	35(14.0)	49.2	0.001**
Pesticides, fertilizers, and agricultural soil have a role in transmitting or preventing black fungi infection	115(46.0)	135(53.0)	193(77.2)	57(22.8)	88.3	0.001**

**Table (6) Spearman's Correlation between knowledge about who is eligible to covid vaccination and attitude and concern and knowledge regarding black fungi after the health Literacy program (N=249)**

Studied variables	Knowledge regarding who is eligible to covid vaccination	
	r	P-value
Attitude toward COVID 19 vaccine	0.193	0.002**
Concern about COVID 19 vaccine	0.383	0.001**
knowledge regarding black fungi	0.466	0.001**

\*\*High significant





Amal I Khalil et al.,

Table (7): Relation between knowledge regarding who is eligible to covid vaccination, attitude, concern, and Socio-demographic data of the studied groups

Studied variables	Knowledge regarding who is eligible to covid vaccination	Test of sig P-value	Attitude toward COVID 19 Vaccine	Test of sig P-value	Concern toward COVID 19 Vaccine	Test of sig P-value	Beliefs toward COVID 19 Vaccine	Test of sig P-value	knowledge regarding black fungi	Test of sig P-value
	Mean ±SD		Mean±SD		Mean±SD		Mean ±SD		Mean±SD	
Age / years	≤22	U	7.39±3.58	U	11.2±4.69	U	11.8±6.90	U	7.39±2.56	U
	>22	0.643	7.90±3.56	0.189	12.2±5.07	0.314	11.2±7.03	0.606	7.92±2.42	0.314
Gender	Male	U	6.80±3.35	U	11.9±4.67	U	9.76±7.81	U	7.55±3.35	U
	Female	0.754	8.58±3.71	0.002**	12.6±4.67	0.357	13.3±6.63	0.002**	8.12±2.35	0.357
Residence	Rural	U	8.08±3.77	U	12.5±5.18	U	12.6±7.14	U	8.00±2.38	U
	Urban	0.263	8.58±3.48	0.414	12.6±4.06	0.989	12.6±6.76	0.104	8.01±2.59	0.989
Educational level	Bachelors	K 54.3 <b>0.001**</b>	7.49±3.52	K 40.6 <b>0.001**</b>	11.5±4.86	K 56.6 <b>0.001**</b>	11.2±6.87	K 43.3 <b>0.001**</b>	7.58±2.52	K 48.6 <b>0.001**</b>
	Masters		11.3±2.33		16.3±2.03		18.4±3.13		9.78±0.53	
	PhD		11.2±3.12		17.0±1.84		17.9±5.30		9.70±0.46	
	Post-doctorate		11.5±3.53		18.0±0.00		20.0±2.82		10.0±0.00	
Place of work	Hospital	U	9.00±2.59	U	11.6±6.42	U	12.5±3.28	U	7.00±3.29	U
	Nursing faculty	1.58	8.14±3.78	0.151	12.6±4.76	0.128	12.6±7.27	0.039	8.09±2.33	0.128
Socioeconomic status	Low	K 0.364 0.834	10.6±1.34	K 4.14 0.126	15.6±5.36	K 4.36 0.113	19.8±4.02	K 7.71 <b>0.021*</b>	9.80±0.44	K 5.10 0.078
	Middle		8.12±3.70		12.4±4.89		12.4±6.89		7.96±2.43	
	High		10.2±4.54		14.8±4.60		16.8±7.03		8.00±3.08	

U: Mann Whitney test K: Kruskal Wallis test \*\*High significant





Amal I Khalil et al.,

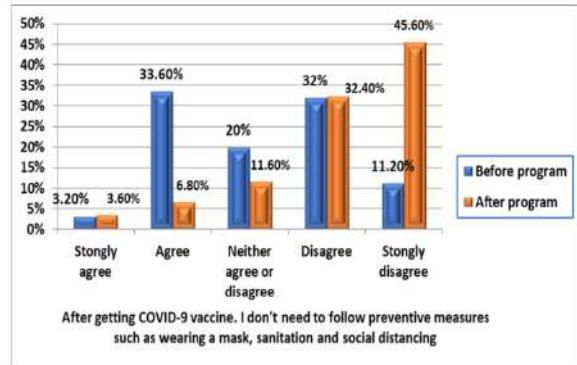
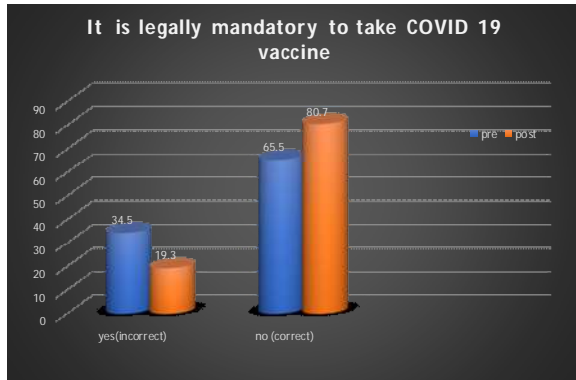


Figure 1. Nursing staff's knowledge regarding legally mandatory to take COVID-19 vaccine pre and post the Health Literacy Program (N=249).

Figure 2. Practice preventive measures after getting COVID-19 vaccine pre and post-Health Literacy Program among studied nursing staff. (N=249)

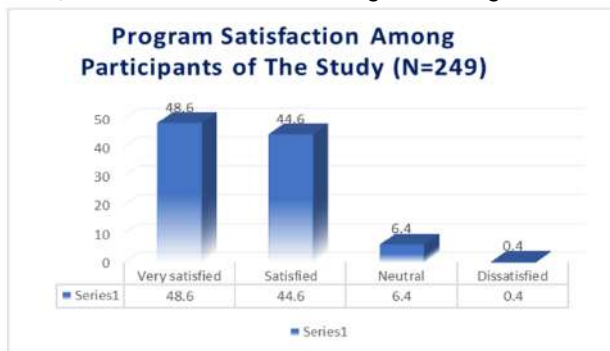


Figure 3. Program Level Of Satisfaction With The Program Contents Among Studied Participants (N=249)





## A Comparative Analysis on Structural and Photoluminescence Properties of Dysprosium, Neodymium and Europium Doped Strontium Aluminates Nanophosphors

Swati Kurmi<sup>1\*</sup>, Praveen Kumar Litoriya<sup>1</sup> and Ashish Verma<sup>2</sup>

<sup>1</sup>Research Scholar, Department of Physics, Dr. Harisingh Gour Central University Sagar, M.P, India.

<sup>2</sup>Professor, Department of Physics, Dr. Harisingh Gour Central University Sagar, M.P, India.

Received: 01 Nov 2021

Revised: 16 Dec 2021

Accepted: 08 Jan 2022

### \*Address for Correspondence

**Swati Kurmi\***

Research Scholar,

Department of Physics,

Dr. Harisingh Gour Central University Sagar,

M.P, India.

E.Mail: swatikurmi1@gmail.com



This is an Open Access Journal / article distributed under the terms of the **Creative Commons Attribution License** (CC BY-NC-ND 3.0) which permits unrestricted use, distribution, and reproduction in any medium, provided the original work is properly cited. All rights reserved.

### ABSTRACT

In the present investigation, the rare earth doped aluminates and accepted phosphor  $\text{SrCaAl}_{12}\text{O}_{19}:\text{Dy}^{2+0.03}$ ;  $\text{SrMgAl}_{12}\text{O}_{19}:\text{Nd}^{2+0.03}$ ; and  $\text{SrBaAl}_{12}\text{O}_{19}:\text{Eu}^{2+0.03}$  were synthesized by urea fuel combustion method. Phase description, morphological exploration and elemental analysis were measured by operating X-ray diffraction, Field emission scanning electron microscopy (FE-SEM) and EDS spectra. The peaks in the X-ray diffraction patterns are introduced to be well fitted with the hexagonal phase (JCPDS card number 89-2505). The EDS study of the phosphors was confirmed the presence of doping of rare earth activator Nd, Dy and Eu in host matrix compounds. Optical properties were study by spectroscopic photoluminescence techniques of the synthesized phosphors. The phosphors  $\text{SrCaAl}_{12}\text{O}_{19}:\text{Dy}^{2+0.03}$  shows prominent PLE peaks at 475 nm, 570 nm;  $\text{SrMgAl}_{12}\text{O}_{19}:\text{Nd}^{2+0.03}$  shows PLE peaks at 573 nm and  $\text{SrBaAl}_{12}\text{O}_{19}:\text{Eu}^{2+0.03}$  shows PLE peaks at 538 nm, 590 nm, 614 nm. The PLE-intensity is found to be comparable and higher with that of  $\text{SrCaAl}_{12}\text{O}_{19}:\text{Dy}^{2+0.03}$  phosphor. Therefore, the reported aluminates samples having good intensity and then it may be used in lighting application.

**Keywords:** EDS, electron microscopy, properties, earth.





Swati Kurmi et al.,

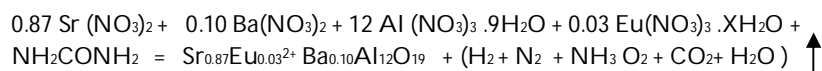
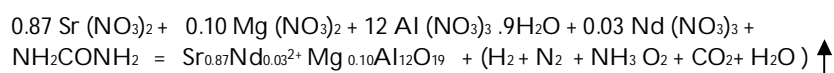
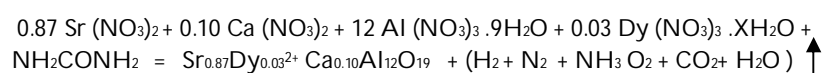
## INTRODUCTION

Photoluminescence is a technique used to characterize the optoelectronic properties of semiconductors and other materials. Photoluminescence spectroscopy is a multi-applicable and gentle method to investigate the electronic structure of materials [1]. When light go down on the sample, it is absorbed and spreads excess energy into the material in a process called photo excitation. An excitation by a UV lamp or ionizing radiation's makes electrons and holes shift from the valence band to the conduction band, there are confined by crystalline defects. Electrons and holes ensnared are resift by thermal activation, and reunification of donor-acceptor complexes produce emissions of light due to many overlapping bands [2]. Thus the emission of luminescence spectra is obtained. Definite PL phosphors are now used regularly in many applications for lighting, environmental monitoring, and medical applications. A large number of phosphors are now available in various physical forms such as single crystals, chips in different thickness, micro-rods, sintered pellets, and as thin substrates for beta and charged particle photometry. However, among a large number of PL materials investigated and described in the literature [3], only a few have been to be attractive for dosimetry purposes, especially for application in connection with personnel and environmental photometry. The aluminates-based phosphor are widely used in plasma display panels, field emission display and fluorecence lamp etc. [4-5]. Various aluminates are used as hosts for doping rare earth ions e.g. BaMgAl<sub>10</sub>O<sub>17</sub>:Eu<sup>2+</sup> and CeMgAl<sub>10</sub>O<sub>17</sub>:Tb<sup>3+</sup> are lamp phosphors, RAlO<sub>3</sub>:Ce<sup>3+</sup> (R = Y and Gd) as scintillates materials, MMgAl<sub>10</sub>O<sub>17</sub>:Eu<sup>2+</sup> (M = Ba, Sr) are among the recent commercially exploited luminescent materials [6-9]. Many researchers have concentrated to developed aluminates as a lamp, scintillators, flat panel display x-ray imaging, and phosphors. During the course our investigation of aluminates based materials.

### Experimental

#### Synthesis of SrCaAl<sub>12</sub>O<sub>19</sub>:Dy<sup>2+0.03</sup>; SrMgAl<sub>12</sub>O<sub>19</sub>:Nd<sup>2+0.03</sup>; and SrBaAl<sub>12</sub>O<sub>19</sub>:Eu<sup>2+0.03</sup>

Rare earth doped aluminates based Phosphors SrCaAl<sub>12</sub>O<sub>19</sub>: Dy<sup>2+0.03</sup>; SrMgAl<sub>12</sub>O<sub>19</sub>: Nd<sup>2+0.03</sup>; and SrBaAl<sub>12</sub>O<sub>19</sub>: Eu<sup>2+0.03</sup> were prepared by combustion method [10-12]. Starting materials were taken metal nitrates (oxidizer), and urea (fuel) for combustion reaction. All constituents in stoichio metric proportions, along with fuel and oxidizer were mixed together. The mixture on thoroughly grinding was transferred to a preheated furnace at 540 °C. On rapid heating, the mixture evaporates and ignites to yield a white product. Entire process completes within a few minutes. Hence the combustion synthesis offers an efficient and easy way for the phosphor preparation.



#### Phosphors characterization techniques

The X-ray Diffractometer was adapted to obtain information about the crystal size, crystallinity, particle size of the succeed powdered material. Field Emission Scanning Electron Microscopy and EDS Spectra were used to achieve details about the surface structure, surface morphology and particle size, pore size, purity, elemental analysis, etc. To study PL characteristics, the excitation spectra and emission spectra were measured using Photoluminescence spectrometer (RF- 5301 PC Shimadzu Model).





Swati Kurmi et al.,

## RESULTS AND DISCUSSIONS

### Powder X-ray diffraction (PXRD) analysis

The x-ray diffraction patterns (Fig. 2) indicate that the crystal structure of SrCaAl<sub>12</sub>O<sub>19</sub>: Dy<sup>2+</sup><sub>0.03</sub>; SrMgAl<sub>12</sub>O<sub>19</sub>: Nd<sup>2+</sup><sub>0.03</sub>; and SrBaAl<sub>12</sub>O<sub>19</sub>: Eu<sup>2+</sup><sub>0.03</sub>; phosphor are mainly hexagonal and matches well to the JCPDS data file no. 89-2505 [13]. The diffraction intensity is maximum for [114] plane having angle (2theta) =35.279° for all phosphors. FWHM value for Nd<sup>2+</sup>-phosphor has been found 0.15 radian, for Dy<sup>2+</sup>-doped phosphor 0.12 radian and for Eu<sup>2+</sup>-phosphor has been found 0.13 radian. The particle size was calculated using Scherer formula ( $D = \frac{K\lambda}{\beta \cos \theta}$ ) and it was found to be 62.20 nm for Dy<sup>2+</sup> doped Phosphor, 59.88 nm for Nd<sup>2+</sup> doped Phosphor and 78.48 nm for Eu<sup>2+</sup> doped Phosphor phosphors [14].

### Scanning electron microscopy and EDS analysis

The Energy-dispersive X-ray (EDS) spectroscopy was used to examine the elemental composition of SrCaAl<sub>12</sub>O<sub>19</sub>: Dy<sup>2+</sup><sub>0.03</sub>; SrMgAl<sub>12</sub>O<sub>19</sub>: Nd<sup>2+</sup><sub>0.03</sub>; and SrBaAl<sub>12</sub>O<sub>19</sub>: Eu<sup>2+</sup><sub>0.03</sub> phosphor. The powder was imaged using backscattered electron detection mode. It can be observed from the low-resolution SEM micrographs that the powders show fig 3 (a-c) many agglomerates and irregular particle arrangement [15]. The EDX study confirmed the presence of doping of Nd and Dy in phosphor compounds. The EDS spectra confirm the elemental composition of the synthesized phosphor as shown in Fig. 4 (a-b). Several specific lines in the EDS spectra show the presence of elements in the EDS pattern of the phosphors.

### Photoluminescence (PL) analysis

The dysprosium (Dy<sup>2+</sup>), neodymium (Nd<sup>2+</sup>) and europium (Eu<sup>2+</sup>) rare earth activated different alkaline hexagonal aluminates phosphor have given a reasonable response to the photoluminescence characteristics [16]. The excitation and emission spectra of SrCaAl<sub>12</sub>O<sub>19</sub>: Dy<sup>3+</sup><sub>0.03</sub>; SrMgAl<sub>12</sub>O<sub>19</sub>: Nd<sup>2+</sup><sub>0.03</sub>; and SrBaAl<sub>12</sub>O<sub>19</sub>: Eu<sup>2+</sup><sub>0.03</sub>. Were noted and displayed in the fig 5 (a and b). The excitation spectra were collected over a range of 350 nm to 500 nm and similarly the emission spectra were collected from 450 nm to 650 nm. In excitation spectra the peak for SrMgAl<sub>12</sub>O<sub>19</sub>: Nd<sup>2+</sup><sub>0.03</sub> observed at 352 nm and for SrCaAl<sub>12</sub>O<sub>19</sub>: Dy<sup>2+</sup><sub>0.03</sub> observed at 361 nm, 366 nm, 381 nm, 395 nm. The excitation spectra for SrBaAl<sub>12</sub>O<sub>19</sub>: Eu<sup>2+</sup><sub>0.03</sub>. were noted at 397nm and 464 nm. Similarly In emission spectra the peak for SrMgAl<sub>12</sub>O<sub>19</sub>: Nd<sup>2+</sup><sub>0.03</sub> observed at 573 nm (yellow) and for SrCaAl<sub>12</sub>O<sub>19</sub>: Dy<sup>2+</sup><sub>0.03</sub> observed at 475 nm (blue), 570 (yellow) [17]. The emission spectra for SrBaAl<sub>12</sub>O<sub>19</sub>: Eu<sup>2+</sup><sub>0.03</sub>. were noted at 538 nm (green) nm, 590 nm (orange), and 614 nm (red) The above results show the PLE intensity in, Dy<sup>2+</sup> activated hexagonal aluminates based phosphors is higher as compared to conventional Nd<sup>2+</sup> doped SrMgAl<sub>12</sub>O<sub>19</sub> and Eu<sup>2+</sup> doped SrBaAl<sub>12</sub>O<sub>19</sub> phosphor [18]. The main objective of this study is just to make declaration about preliminary and qualitative results, related to PLE behavior of these types of materials. Consequently, the new directions have been opened for investigation of new photometry phosphors, in aluminates based materials. Additional research should be executed to understand the mechanism of the occurrence of PLE spectra in these materials. By reason of our results, the above phosphors may be advised as photometry phosphors of ionization.

Fig 6 shows the CIE chart of for SrCaAl<sub>12</sub>O<sub>19</sub>: Dy<sup>2+</sup><sub>0.03</sub>; SrMgAl<sub>12</sub>O<sub>19</sub>: Nd<sup>2+</sup><sub>0.03</sub>; and SrBaAl<sub>12</sub>O<sub>19</sub>: Eu<sup>2+</sup><sub>0.03</sub>. The color coordinates are calculated using the GoCIE software utilizing emission spectra and are reported in Tables 2. It has been seen that the coordinates of CIE chromaticity lie in the blue region for Dy<sup>2+</sup> and Nd<sup>2+</sup> activated phosphor and red region for Eu<sup>2+</sup> activated phosphor. The tallied values of CCT are inducted in Tables 2. From the results, it can be observed that the prepared Dy<sup>2+</sup> doped SrCaAl<sub>12</sub>O<sub>19</sub> phosphor material is an application in hurricane lamps and cash light on living places and solid state lighting.

## CONCLUSION

SrCaAl<sub>12</sub>O<sub>19</sub>: Dy<sup>2+</sup><sub>0.03</sub>; SrMgAl<sub>12</sub>O<sub>19</sub>: Nd<sup>2+</sup><sub>0.03</sub>; and SrBaAl<sub>12</sub>O<sub>19</sub>: Eu<sup>2+</sup><sub>0.03</sub>; phosphor were synthesized by combustion method using the urea as fuel. The crystal structure and morphology of synthesized phosphors were characterized



**Swati Kurmi et al.,**

by XRD, FESEM, and EDS. The PL spectroscopy was used to examine luminescent properties of synthesized phosphor. Maximum intensity in emission spectra is observed for Dy<sup>2+</sup> in blue region due to the allowed and forbidden of Dy<sup>2+</sup> to Dy<sup>3+</sup>. The spectrum spectra reveals strong peak in orange region attributed to the 4f-5d transition of Nd<sup>2+</sup> ions [39]. While the possibility of the red region with comparatively weaker intensity is of attributes to <sup>5</sup>D<sub>0</sub> - <sup>7</sup>F<sub>j</sub> (j= 0,1,2,3 ...) transition of the Eu<sup>2+</sup> ions. Synthesized phosphor particles can be used for security printing, solid state illumination, or for optical displays.

## ACKNOWLEDGMENTS

The authors are grateful to Dr. Harisingh Gour Central University, sagar (M.P.) India , for Providing SIC experiment facilities and for financial support central university research fellowship .

## REFERENCES

1. G.B. Nair, S.J. Dhoble, A perspective perception on the applications of light-emitting diodes, *Luminescence*. 30 (2015) 1167–1175, <https://doi.org/10.1002/bio.2919>
2. C.C. Lin, R.S. Liu, Advances in phosphors for light-emitting diodes, *J. Phys. Chem. Lett.* 2 (2011) 1268–1277, <https://doi.org/10.1021/jz2002452>.
3. H. Singh Virk, History of luminescence from ancient to modern times, *Defect Diffusion Forum* 361 (2015) 1–13.
4. Ronda, *Luminescence from Theory to Application*, WILEY-VCH Verlag GmbH & Co. KGaA, Weinheim, 2008, pp. 1–248.
5. C.C. Lin, R.S. Liu, Advances in phosphors for light-emitting diodes, *J. Phys. Chem. Lett.* 2 (2011) 1268–1277, <https://doi.org/10.1021/jz2002452>.
6. D.P. Dutta, R. Ghildiyal, A.K. Tyagi, Luminescent properties of doped zinc aluminate and zinc gallate white light emitting nanophosphors prepared via sonochemical method, *J. Phys. Chem. C*. 113 (2009) 16954–16961, <https://doi.org/10.1021/jp905631g>.
7. S. Ekambaram, K.C. Patil, M. Maaza, Synthesis of lamp phosphors: facile combustion approach, *J. Alloys Compd.* 393 (2005) 81–92.
8. P. Halappa, C. Shivakumar, Synthesis and characterization of luminescent La<sub>2</sub>Zr<sub>2</sub>O<sub>7</sub>/Sm<sup>3+</sup>+polymer nanocomposites, *Trends and Applications in Advanced Polymeric Materials* (2017) 163–190.
9. A.K. Verma, Ashish Verma, G.V. Bramhe, Shifting and enhanced photoluminescence performance of the Sr<sub>1-x</sub>EuxMgAl<sub>10</sub>O<sub>17</sub> phosphor, *J. Alloys Compd.* 774 (2019) 1168–1180.
10. A.K. Verma, A. Verma, G.V. Bramhe, I.P. Sahu, Optical studies of the Ba<sub>1-x</sub>MgAl<sub>10</sub>O<sub>17</sub>:Eu phosphor synthesis by combustion route, *J. Alloys Compd.* 769 (2018) 831–842
11. Sanjay Kumar Pathak , Aksh Kumar Verma , Ishwar Prasad Sahu , Photo and Mechano – luminescence properties of novel Zn<sub>1-x</sub>Eu<sub>x</sub>Al<sub>2-y</sub>Ba<sub>y</sub>O<sub>4</sub> advance blue phosphor , November 2020. *Physica condensed matter* 602(8) , <https://doi.org/10.1016/j.physb.2020.412612>
12. ] Sanjay Kumar Pathak , Aksh Kumar Verma , Ashish Verma , structural and Photoluminescence properties of Eu<sup>3+</sup> activated ZnAl<sub>2</sub>O<sub>4</sub> orange red phosphor , October 2020. *Journal of Material science : Materials in Electronics* <https://doi.org/10.1007/s1085-020-03715-x>.
13. Kapil Dev ,Anupam Selot , Govind B.Nair , Chaitali M.Mehare , Fozia Z. Haque , M.Anyas , S.J.Dhoble Synthesis and photoluminescence study of Dy<sup>3+</sup> activated SrAl<sub>12</sub>O<sub>19</sub> phosphor, July 2019. *Optic – International Journal for Light and Electron Optics* 194(2019) 163051 <https://doi.org/10.1016/j.ijleo.2019.163051>
14. Aksh Kumar Verma , Ashish Verma , Maheswar Panda , Mechano-luminescence studies of nano Zn MgAl<sub>10</sub>O<sub>17</sub> : Eu phosphor Under UV irradiation , May 20018. *AIP Conference Proceeding* 1953 (1): 030037 <https://doi.org/10.1063/1.5032372>.
15. Sanjay Kumar Pathak , Aksh Kumar Verma , Ishwar Prasad Sahu , Photo and Mechano – luminescence properties of novel Zn<sub>1-x</sub>Eu<sub>x</sub>Al<sub>2-y</sub>Ba<sub>y</sub>O<sub>4</sub> advance blue phosphor , November 2020. *Physica condensed matter* 602(8) , <https://doi.org/10.1016/j.physb.2020.412612>.





Swati Kurmi et al.,

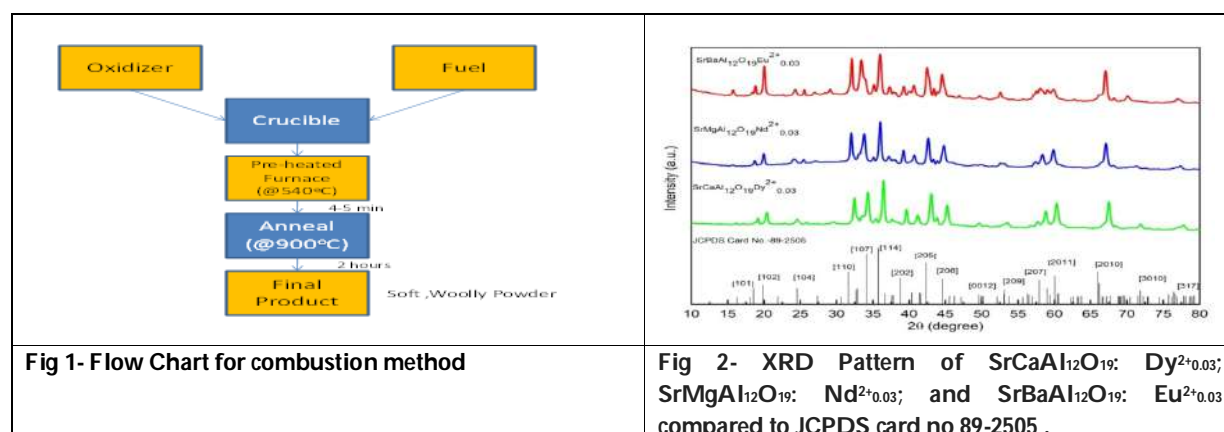
16. Aksh Kumar Verma , Sanjay Kumar Pathak , Ashish Verma , G.V. Bramhe , Tuning of luminescence properties of  $Zn_{1-x}MgAl_{10}O_{17}:Eu_x$  nano phosphor , June 2018. Journal of Alloys and Compounds 764 [https : // doi.org/10.1016/j-jallcom.2018.06.023](https://doi.org/10.1016/j.jallcom.2018.06.023).
17. Kapil Dev , Anupam Selot , Govind B. Nair , Chaitali M Mehare , Fozia Haque , M . Aynyas , S.J. Dhoble Synthesis and photoluminescence study of  $Dy^{3+}$  activated  $SrAl_{12}O_{19}$  phosphor , July 2019 Optik –International Journal for Light and Electronic Optics [https : // doi.org/10.1016/j-ijleo.2019.163051](https://doi.org/10.1016/j-ijleo.2019.163051).
18. A.K Verma, S.K. Pathak, A. Verma, G.V. Brambe, I.P. Sahu, Tuning of luminescent properties of  $Zn_xMgAl_{10}O_{17}:Eu$ , nano phosphor, J. Alloys Compd. 764 (2018) 1021-1032.

Table 1. FWHM values, crystal size , d-spacing and Miller indices for  $SrCaAl_{12}O_{19}: Dy^{2+0.03}$ ;  $SrMgAl_{12}O_{19}: Nd^{2+0.03}$ ; and  $SrBaAl_{12}O_{19}: Eu^{2+0.03}$   $SrCaAl_{12}O_{19}:Dy^{2+}$  Phosphor

Samples	2θ (degree)	FWHM (degree)	Crystal Size (nm)	Micro Strain	d-Spacing (nm)	Miller Indices (hkl)
$SrCaAl_{12}O_{19}:Dy^{2+0.03}$	36.18	0.12	62.20	0.009	0.19	[1011]
$SrMgAl_{12}O_{19}:Nd^{2+0.03}$	32.46	0.15	59.88	0.011	0.15	[1015]
$SrBaAl_{12}O_{19}:Eu^{2+0.03}$	20.38	0.13	78.48	0.005	0.26	[200]
Samples	2θ (degree)	FWHM (degree)	Crystal Size (nm)	Micro Strain	d-Spacing (nm)	Miller Indices (hkl)
$SrCaAl_{12}O_{19}:Dy^{2+0.03}$	36.18	0.12	62.20	0.009	0.19	[1011]
$SrMgAl_{12}O_{19}:Nd^{2+0.03}$	32.46	0.15	59.88	0.011	0.15	[1015]
$SrBaAl_{12}O_{19}:Eu^{2+0.03}$	20.38	0.13	78.48	0.005	0.26	[200]

Table 2 . Correlated coordinates of chromacity (x,y) and correlated temperature (CCT) for  $SrCaAl_{12}O_{19}: Dy^{2+0.03}$  ;  $SrMgAl_{12}O_{19}: Nd^{2+0.03}$  ; and  $SrBaAl_{12}O_{19}: Eu^{2+0.03}$

Sr no		Color coordinate		CCT ( K)
		X	y	
1	$SrCaAl_{12}O_{19}:Dy^{2+0.03}$	0.31	0.30	6975
2	$SrMgAl_{12}O_{19}:Nd^{2+0.03}$	0.30	0.29	7976
3	$SrBaAl_{12}O_{19}:Eu^{2+0.03}$	0.50	0.35	1799







Swati Kurmi et al.,

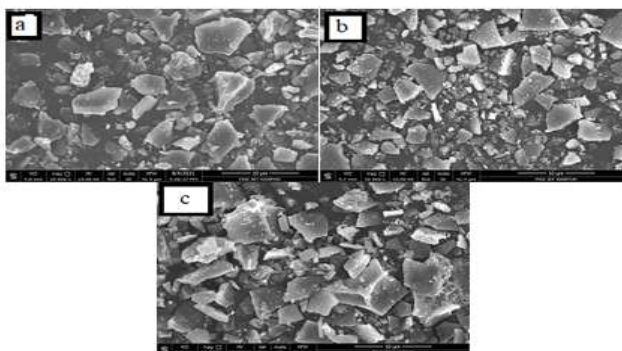


Fig 3 – SEM images of SrCaAl<sub>12</sub>O<sub>19</sub>: Dy<sup>2+</sup>0.03 ; SrMgAl<sub>12</sub>O<sub>19</sub>: Nd<sup>2+</sup>0.03 ; and SrBaAl<sub>12</sub>O<sub>19</sub>: Eu<sup>2+</sup>0.03

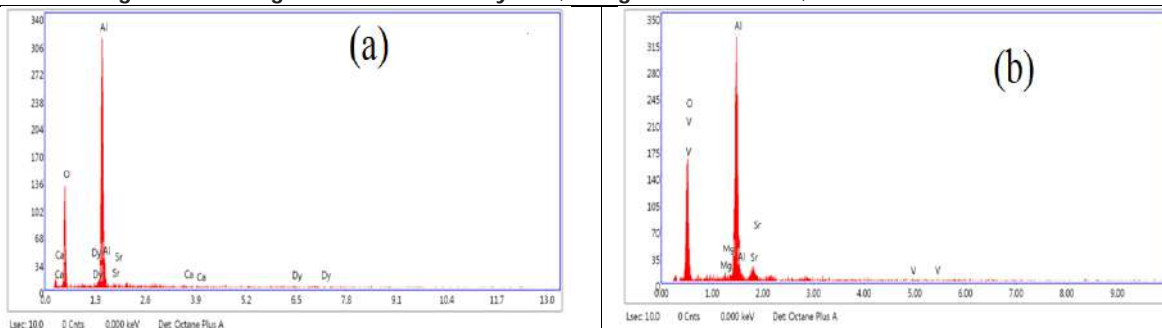


Fig 4 EDS Spectra for SrCaAl<sub>12</sub>O<sub>19</sub>: Dy<sup>2+</sup>0.03 ; SrMgAl<sub>12</sub>O<sub>19</sub>: Nd<sup>2+</sup>0.03 ; and SrBaAl<sub>12</sub>O<sub>19</sub>: Eu<sup>2+</sup>0.03

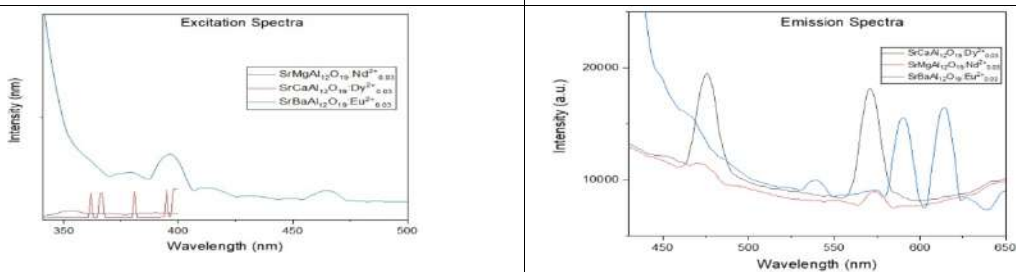


Fig 5 PL Excitation and Emission spectra for SrCaAl<sub>12</sub>O<sub>19</sub>: Dy<sup>2+</sup>0.03 ; SrMgAl<sub>12</sub>O<sub>19</sub>: Nd<sup>2+</sup>0.03 ; and SrBaAl<sub>12</sub>O<sub>19</sub>: Eu<sup>2+</sup>0.03

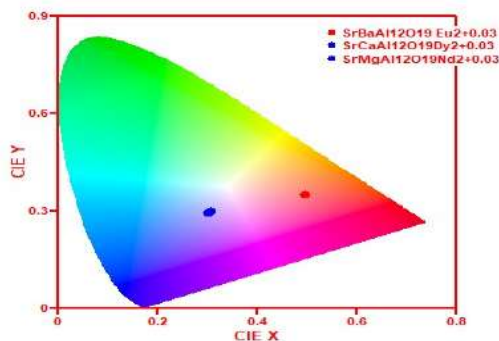


Fig. 6 CIE Spectra for for SrCaAl<sub>12</sub>O<sub>19</sub>: Dy<sup>2+</sup>0.03 ; SrMgAl<sub>12</sub>O<sub>19</sub>: Nd<sup>2+</sup>0.03 ; and SrBaAl<sub>12</sub>O<sub>19</sub>: Eu<sup>2+</sup>0.03 Phosphor





## A Survey of Spiders Diversity in Three Agricultural Field Areas: The First Report of Tamil Nadu in India

Kannadasan R<sup>1\*</sup> and Senthil Kumar D<sup>2</sup>

<sup>1</sup>Assistant Professor of Zoology, Kandaswami Kandar's College, Paramathi Velur, Namakkal Dt., Tamil Nadu, India.

<sup>2</sup>Associate Professor of Zoology, Kandaswami Kandar's College, Paramathi Velur, Namakkal Dt., Tamil Nadu, India.

Received: 27 Sep 2021

Revised: 15 Nov 2021

Accepted: 12 Jan 2022

### \*Address for Correspondence

#### Kannadasan R

Assistant Professor of Zoology,  
Kandaswami Kandar's College,  
Paramathi Velur, Namakkal Dt.,  
Tamil Nadu, India.

Email: kannan198312@gmail.com



This is an Open Access Journal / article distributed under the terms of the **Creative Commons Attribution License** (CC BY-NC-ND 3.0) which permits unrestricted use, distribution, and reproduction in any medium, provided the original work is properly cited. All rights reserved.

### ABSTRACT

The present article deals with the fauna diversity of the spiders in Agricultural areas. A total of 19 species under 9 genera were recorded in Anichampalayam site-I (S-I), Nanjai Edayar site-II (S-II), and Pandamangalam site-III (S-III), Namakkal District, Tamil Nadu in India. Maximum 32% of spider species were recorded in Araneidae, followed by Tetragnathidae, Salticidae, Sparassidae, Oxyopidae, Clubionidae, Gnaphosidae, Hersiliidae and Lycosidae. A very high number of spider species was found in site III (504), followed by site II (404), and site I (376). An extensive survey for these spiders is required in almost 3 sites particularly in those where these jumping spiders are either not recorded. Despite the spiders are the most diverse group of predators and is crucial to the health of terrestrial ecosystems, none of the species recorded in India is listed in IUCN Red List.

**Keywords:** spider, diversity, agriculture field, species abundance, species richness.

### INTRODUCTION

Rice (*Oryza sativa*) is an essential food source for more than 50% of the world population with an annual yield of more than 700 tons roughly (Center Africa Rice, 2011; Seck *et al.*, 2012). India, China, Thailand, Bangladesh, Philippines, Pakistan, Indonesia, USA and Vietnam are among the major rice producers (Mehmood *et al.*, 2021). Oerke (2006); Xie and Yang (2018) and Savary *et al.*, (2019) reported that from the past years, the productivity of rice at the global level is at risk due to different crop diseases and pest infestations. Insect pests of rice cause a loss of 200 million tons every year (Nasiruddin and Roy, 2012; Singh and Singh, 2017). Synthetic pesticides are extensively used

38453



**Kannadasan and Senthil Kumar**

to control the outbreak of pests (Karunamoorthi and Mohammed, 2012; Wengand Black, 2015). Their unnecessary use of pesticides causes negative impacts on human health, environment and agriculture production by rigorously damaging the flora and fauna (Houbraken *et al.*, 2016; Rosic *et al.*, 2020). John and Shaik (2015) reported that the natural balance between pests and predators has been greatly disturbed due to the careless use of pesticides which are accountable for the non-target killing of natural enemies

Spiders are the natural predators present abundantly in the rice ecosystem and limit the population of other insect pests (Maloney *et al.*, 2003; Thomson and Hoffmann, 2010. Radermacher *et al.*, 2020). They are tremendous predators due to wasteful killing, high reproductive rate, functional and numerical response and their capacity to survive under conditions of food shortage (Nyffeler and Birkhofer, 2017; Michalko *et al.*, 2019). Tyagi *et al.* (2019) testified that accurate identification of spiders is needed to differentiate the native spider fauna from the invasive ones by creating a barcode reference library. Different diagnostic characters like eye and epigynal patterns are used for species-level identification (Barrett and Hebert, 2005). Morphology based identification is quite difficult due to the unavailability of literature and time consumption (Ball and Armstrong, 2006). Robinson *et al.*, 2009 and Hamilton *et al.*, 2011 investigated that the absence of clear distinguishing characters and sexual dimorphism dare the authenticity of phenological identification of spiders. So, there is a critical need to introduce quick, economical and undisputed approaches to investigate the spiders taxonomically (Hebert and Gregory, 2005; Fontaneto *et al.*, 2009; Iftikhar *et al.*, 2016). The current study aimed to document the undescribed fauna of spiders from the Namakkal District of Tamil Nadu in India

## MATERIALS AND METHODS

### Collection of spiders

Live spiders were sampled from different agricultural fields across the Namakkal district including Anichampalayam site-I (S-I), Nanjai Edayar site-II (S-II) and Pandamangalam site-III (S-III), Tamil Nadu, India. The sample collection was done from 2019 to 2020 during the rabi season using different sampling techniques like visual search and sweep netting (Robinson *et al.*, 2009; Tyagi *et al.*, 2019).

### Sampling sites

Three sampling sites were used for the study namely S-I (Latitude- 11.1006° N; Longitude-78.0213° E), S-II (11.0980° N; 78.0345° E) and S-III (11.1028° N; 78.9653° E). There were minor variations in the agronomic practices at all sampling sites. These sampling sites were monoculture rice fields surrounded by grassy strips/bunds (Fig. 1).

### Storage and preservation

Insects were collected in plastic jars (4×6 inches) containing 75% ethanol. Collected specimens were brought to the laboratory in the Department of Zoology, Kandaswami Kandar's College, Paramathi Veiur, Namakkal District of Tamil Nadu. After washing with alcohol spiders were transferred to clean glass vials (20 ml) with the help of forceps for morphological study containing Odd man's solution (70% ethanol, 15% glacial acetic acid and 15% glycerol).

### Data analysis

Calculations of spider diversity and dominance were based on adult individuals only. The collected data were subjected to Diversity Index (Species richness [S], Evenness and Shannon Index) by PAST statistical software. To find out the relationships between spiders and different abiotic and biotic factors, correlation analysis was performed. Because the data were not normally distributed (Kolmogorov - Smirnov test), Spearman's rank correlation method requires at least seven pairs of observations (Fowler *et al.*, 1998), only the most abundant spider species were included in the analysis. The relationships were analyzed between individual spider species or spider diversity indices and different vegetation and non-vegetation variables. The statistical significance of the correlation analysis was checked by comparing coefficient  $r_s$  with the obtained  $p$  value. PCA was performed by Palaeontological Statistics (PAST) version 3.06





## RESULTS

### Percentage composition of spider groups

In the present investigation, 1079 spiders were identified from the selected agriculture area and they are representing 19 species that belong to 9 families. Out of the total catch, 148 spiders were immature and identified up to the genus level due to the unavailability of keys for juvenile identification. However, the remaining 1136 specimens were mature. Several diversity indices were used in the present study to measure the spider species diversity. The percentage composition of spider diversity in the agriculture field was calculated, maximum of 32% of spider species were recorded in Araneidae, followed by Tetragnathidae (16%), Salticidae (11%), Sparassidae (11%), Oxyopidae (10%), Clubionidae (5%), Gnaphosidae (5%), Hersiliidae (5%) and Lycosidae (5%) and they were shown in Fig. 2. Site III showed total species of 504, followed by site II 404 species and site I 376 species in the total number of species 1284 (Table 1).

Araneidae family was found to be the 6 species such as *A. catenulata* (Fig. 4a), *A. anasuja* (Fig. 4b), *A. picta* (Fig. 4c), *A. ventricosus* (Fig. 4d), *A. diadematus* (Fig. 4e) and *N. crucifera* (Fig. 4f) abundant followed by Tetragnathidae family 3 species (*T. elongate*, *T. guatemalensis* and *T. laboriosa*) (Fig. 5 a, b, c), Salticidae family 2 species (*T. dimidiata*, *T. elegans*) (Fig. 6a, b) and Sparassidae family 2 species (*H. venatoria*, *O. millet*) (Fig. 7a, b), Oxyopidae family 2 species (*P. viridans*, *O. macilentus*) (Fig. 8a, b), Clubionidae family (*C. terrestris*) (Fig. 9), Gnaphosidae family (*S. montanus*) (Fig. 10), Hersiliidae family (*H. caudate*) (Fig. 11) and Lycosidae family (*H. aspersa*) (Fig. 12).

### Ecological Indices (Diversity indices)

In the present investigation, various diversity index parameter was studied for the spider diversity which was noted in the 3 different agriculture sites. According to the observation, Richness varies from 16 to 18, True Diversity ranges from 12.5 to 14, Shannon Entropy observed from 2.6268 to 2.7382 and Simpson Dominance range from 7.20% to 8.00%. During this study, compared to all the study areas a maximum species richness was observed in Site III (Table 2).

### Dominance Plot and Group average in the study area

The percentage dominance of the spider community was plotted based on their rank individually and cumulatively. The highest number of species was found in site III at this Pandamangalam (Fig. 3).

### The principal component analysis (PCA)

In the present investigation, the principal component analysis was employed to study variables of spider diversity among selected agriculture sites and the results were represented using a biplot. In the present study, species variables were developed using three principal components. The result showed the influence of different spider species diversity with three selected study sites (Site I, II and III). Angular distance and length of the arrows indicated the positive and negative correlation with the variables assemblage. Figure demonstrated that site III influences greater diversity of spiders than Site I and II (Fig. 13 and 14).

## DISCUSSION

Generally, spiders are considered ingenious predators and they can regulate the huge number of pests and they play a major role in the paddy field pest management. Few works related to spider diversity in paddy plantations were recorded including Pathak and Saha (1998); Ambalaganand Narayanasamy (1999); Bambaradeniya and Edirisinghe (2001); Bambaradeniya *et al.* (2004); Patel *et al.* (2004); Vijaykumar (2004). During the current study we compared the authenticity identification of spiders from three village sites, Namakkal district of Tamil Nadu in India with eye patterns approaches reference library for spider fauna of Tamil Nadu, India. The result obtained from the present investigation was confirmed that paddy crops served as a reservoir for the spider species. About 1079 spiders were identified from the selected agriculture area and they are representing 19 species that belong to 9 families. Ashfaq *et*



**Kannadasan and Senthil Kumar**

al. (2019) reported nearly 38 distinguished morphospecies of spiders. One of the difficulty faced during this study was the accuracy of the morphological examination. Nearly 148 spiders were immature and identification key was not available for those spiders and deprivation of diagnostic characters of juvenile spiders could be the possible reasons for the present less accuracy of morphological evaluation. Another important factor that plays a role in spider diversity was habitat complexity and this reason was also stated in many research findings (Dobel *et al.*, 1990; Gunnarsson, 1990). Paddy field ecosystems were generally very simple and relatively few substrates were required for web building and hunting and added to it the complexity of increased time as the plants grow and this could be a reason spider species abundance in the present study. According to Stokmane and Spungis (2014), diversity indices suggested that the grass-dwelling spider community consists of few abundant species and numerous rare species. In another study, Ambalagan and Narayanasamy (1999) concluded that both spider abundance and richness is linked to the various phase of rice growth. Spungis (2005) was the one reported Latvia spider species in the year 2004 and this was followed by Cera *et al.*, (2010). In the present study, Araneidae was noted as a dominant family in the selected study area and this was correlated with the finding of Manju *et al.* (2005) and Shegokar (2012). According to the observation of Tiwari and Singh (2021), only 3 species of spiders are distributed widely; *Dendrolycosa gitae* (11 Indian states, 1 Union territory), *Nilus albocinctus* (8 Indian states, 1 Union Territories), and *Perenethis venusta* L. (8 Indian states). In another study, family of Araneidae constituting 4 species from 3 genera in Mannavan Shola Forest, in Kerala. The increased spider population belongs to Araneidae and Tetragnathidae (orb-web spiders) could be due to mixed vegetation of the forest, which provides enough space to build webs of different sizes and protection from predators (Sudhikumar *et al.*, 2005). Further, vegetation structure has been hypothesized to influence spiders diversity, but this impact may present in Specific subgroups or guilds within spiders (Rodrigues *et al.*, 2014). Nevertheless, there were quite a lot of associations between spiders and individual plant species. The DCA showed quite a similar pattern- some of the individual plant species were fairly important for spider communities. These reports partly support research by other authors (Uetz, 1991; Pozzi *et al.*, 1998; Jimenez-Valverde and Lobo, 2007; Hore and Uniyal, 2008) who have found that vegetation structure is one of the major habitats features explaining spider species composition.

In addition, Araneidae population showed consistent increasing trends among the populations of immature and adults from January to August (Tahir *et al.*, 2009). In Estonia, the investigation surveyed different mire types (including fens, transitional mires and bogs) but these data are quite old materials that were collected by a sweep net from 1947 to 1976 (Vilbaste, 1980). A total of 32 species were discovered from a limited area of Pune University (Wankhade *et al.*, 2012), and out of the 252 genera from the Indian region (Manju *et al.*, 2005), 38 genera are observed in Sellappampatty village. Similar spider genera were recorded in the other Indian spider studies viz., 33 genera in Andaman and Nicobar Islands, 41 genera in Sikkim, 47 genera in Calcutta, 40 genera and 51 species in Mangalavanam, Kerala, India (Tikader, 1977; Tikader *et al.*, 1981; Sebastian *et al.*, 2005).

**CONCLUSION**

Further study will focus on some other sampling periods and growing seasons to evaluate the spider diversity of Tamil Nadu. In addition, our sampling method was restricted only to eyes patterns of spiders, other collection methods are required to be used in future studies to obtain a more complex overview of the spider fauna of the studied habitats. The present study may be considered more like an eyes pattern in morphological studies, and the topic deserves future investigations because there is still a lot to learn about spider fauna.

**ACKNOWLEDGEMENTS**

Authors are gratefully acknowledged to the Associate Professor and Head, Department of Zoology, Kandaswami Kandar's College, Paramathi Velur, Namakkal District, Tamil Nadu in India.





## REFERENCES

1. Ambalagan G and Narayanasamy P. Population Fluctuation of Spiders In The Rice Ecosystem of Tamil Nadu. Entomon-Trivadrum 1999; 24 (1): 91-95.
2. Ashfaq M, Blagoev G, Tahir HM, Khan AM, Mukhtar MK, Akhtar S, Butt A, Mansoor S. and Hebert PDN. Assembling a DNA barcode reference library for the spiders (Arachnida: Araneae) of Pakistan 2019; PLoS One, 14: 5. <https://doi.org/10.1371/journal.pone.0217086>.
3. Ball SL and Armstrong KF. DNA barcodes for insect pest identification: A test case with tussock moths (Lepidoptera: Lymantriidae). Can. J. For. Res 2006; 36: 337-350. <https://doi.org/10.1139/x05-276>.
4. Bamdaradeniya CNB, Edirisinghe JP. The Ecological Role Of Spiders In The Rice Fields Of Sri Lanka. Biodiversity 2001; 2 (4): 3-10.
5. Bambaradeniya CNB, Edirisinghe JP, De Silva DN, Gunatilleke CVS, Ranawana KB, Wijekoon S. Biodiversity Associated With An Irrigated Rice Agro-Ecosystem In Sri Lanka. Biodiversity And Conservation 2004; 13: 1715-1753.
6. Barrett RDH. and Hebert PDN. Identifying spiders through DNA barcodes. Can. J. Zool 2005; 83: 481-491. <https://doi.org/10.1139/z05-024>.
7. Center Africa Rice. Boosting Africa's rice sector: A research for development strategy 2011–2020. Cotonou, Benin; 2011.
8. Cera I, Spunşis V, Melecis V. Occurrence of grass-dwelling spiders in habitats of Lake Engure Nature Park. Environ Exp Biol 2010; 8:59–69.
9. Fontaneto D, Kaya M, Herniou EA and Barraclough TG. Extreme levels of hidden diversity in microscopic animals (Rotifera) revealed by DNA taxonomy. Mol. Phylogen. Evol 2009; 53: 182-189. <https://doi.org/10.1016/j.ympev.2009.04.011>.
10. Fowler J, Cohen L, Jarvis P. Practical statistics for field biology. Wiley, New York; 1998. [11]. Hamilton CA, Formanowicz DR and Bond JE. Species delimitation and phylogeography of
11. Aphonopelmahentzi (Araneae, Mygalomorphae, Theraphosidae): Cryptic diversity in North American tarantulas 2011; PLoS One, 6: e26207. <https://doi.org/10.1371/journal.pone.0026207>.
12. Hebert PDN. and Gregory TR.. The promise of DNA barcoding for taxonomy. Syst. Biol. 2005; 54: 852-859. <https://doi.org/10.1080/10635150500354886>.
13. Hore U, Uniyal VP. Influence of space, vegetation structure, and microclimate on spider (Araneae) species composition in Terai Conservation Area, India. Eur Arachnol (2008) ; 14:71–77.
14. Houbraken M, Bauweraerts I, Fevery D, Van Labeke MC and Spanoghe P. Pesticide knowledge and practice among horticultural workers in the Lâm Đồng region, Vietnam: A case study of chrysanthemum and strawberries. Sci. Total Environ 2016; 550: 1001-1009. <https://doi.org/10.1016/j.scitotenv.2016.01.183>.
15. Iftikhar R, Ashfaq M, Rasool A and Hebert PDN. DNA barcode analysis of thrips (Thysanoptera) diversity in Pakistan reveals cryptic species complexes 2016; PLoS One, 11: e0146014. <https://doi.org/10.1371/journal.pone.0146014>.
16. Jimenez-Valverde A, Lobo JM. Determinants of local spider (Araneidae and Thomisidae) species richness on a regional scale: climate and altitude vs. habitat structure. Ecol Entomol 2007; 32:113– 122
17. Karunamoorthi K and Mohammed M. Knowledge and practices of farmers with reference to pesticide management: implications on human health. Arch. Environ. Occup. Hlth 2012; 67: 109-116. <https://doi.org/10.1080/19338244.2011.598891>.
18. Magurran AE. Measuring biological diversity. Blackwell Publishing, Oxford; 2004.
19. Maloney D, Drummond FA and Alord R. Spider predation in agroecosystems: Can spiders effectively control pest population. MAFES Tech. Bull 2003; 190: 1-32.
20. Manju Siliwal, Sanjay Molur and Biswas BK. Indian Spiders (Arachnida: Araneae): Updated Checklist. Zoos' Print journal 2005; 20(10): 1999-2049.





### Kannadasan and Senthil Kumar

21. Mehmood S, Muhammad Tahir H, Summer M, Sherawat SM, Ali S, Naseem S. Diversity of Spiders in Rice Ecosystems of Punjab, Pakistan. Punjab Univ. J. Zool 2021; 36(2): 09-20. <https://dx.doi.org/10.17582/journal.pujz/2021.36.1.9.20>
22. Michalko R., Pekár S and Entling MH. An updated perspective on spiders as generalist predators in biological control. Oecologia 2019; 189: 2136. <https://doi.org/10.1007/s00442-018-4313-1>.
23. Nasiruddin M and Roy C. Rice Field Insect Pests during the Rice Growing Seasons in Two areas of Hathazari, Chittagong. Bangladesh J. Zool 2012; 40: 89-100. <https://doi.org/10.3329/bjz.v40i1.12898>.
24. Nyffeler M and Birkhofer K. An estimated 400– 800 million tons of prey are annually killed by the global spider community. Sci. Nat 2017; 104: 30. <https://doi.org/10.1007/s00114-017-1440-1>.
25. Oerke EC. Crop losses to pests. J. Agric. Sci 2006; 144: 31-43. <https://doi.org/10.1017/S0021859605005708>
26. Patel ML, Patel KG, Desai HR. Spider Fauna Of Rice Of South Gujarat. Insect Environment 2004; 10 (3): 119-121.
27. Pathak S, Saha NM. Spider Fauna Of Rice Ecosystem In Barak Valley Zone Of Assam, India. Indian J. entomol 1998; 60 (2): 211-212.
28. Pozzi S, Gonseth Y, Ha nggi A Evaluation of dry grassland management on the Swiss occidental plateau using spider communities (Arachnida: Araneae). Rev Suisse Zool 1998; 105:465–485.
29. Radermacher N, Hartke TR, Villareal S and Scheu S. Spiders in rice-paddy ecosystems shift from aquatic to terrestrial prey and use carbon pools of different origin. Oecologia 2020; 1-12. <https://doi.org/10.1007/s00442-020-04601-3>.
30. Robinson EA, Blagoev GA, Hebert PDN and Adamowicz SJ. Prospects for using DNA barcoding to identify spiders in species-rich genera. ZooKeys 2009; 16: 27-46. <https://doi.org/10.3897/zookeys.16.239>.
31. Rodrigues ENL, Mendoncan MDS and CostaSchmidt LE. Spider diversity responds strongly to edge effects but weakly to vegetation structure in riparian forests of southern Brazil. Arthropod Plant Interact 2014; 8: 123-133.
32. Rosic N, Bradbury J, Lee M, Baltrotsky K and Grace S. The impact of pesticides on local waterways: A scoping review and method for identifying pesticides in local usage. Environ. Sci. Policy 2020; 106: 12-21. <https://doi.org/10.1016/j.envsci.2019.12.005>
33. Savary S, Willocquet L, Pethybridge SJ, Esker P, McRoberts N and Nelson A. The global burden of pathogens and pests on major food crops. Nat. Ecol. Evol 2019; 3: 430-439. <https://doi.org/10.1038/s41559-018-0793-y>.
34. Sebastian PA, Murugesan S, Mathew MJ, Sudhikumar AV and Surish E. Spider in Mangalavanam, an eco sensitive mangrove forest in Cochin, Kerala, India. (Araneae). Eur. Arachn, 2005; 1: 315-328.
35. Seck PA, Diagne A, Mohanty S. and Wopereis MC. Crops that feed the world 7. Rice Food Secur 2012; 4: 7-24. <https://doi.org/10.1007/s12571-012-0168-1>.
36. Singh S. and Singh BK. Survey and fortnightly observation to find out major insect pests of rice crop (*Oryza sativa*) in Patna district of Bihar. J. Entomol. Zool. Stud 2017; 5: 766-769.
37. Spungis V. Wasp spider *Argiope bruennichi* (Scopoli, 1772) (Aranea, Araneidae) in Latvia. Latvijas Entomologs 2005; 42:106–107.
38. Stokmane M, Spungis V. Diversity of grass-dwelling spiders (Arachnida: Araneae) in calcareous fens of the Coastal Lowland, Latvia. J Insect Conserv 2014; 18:757–769 <https://doi.org/10.1007/s10841-014-9677-x>.
39. Sudhikumar AV, Mathew MJ, Sunish E, Sebastian PA. Seasonal variation in spider abundance in Kuttanad rice agroecosystem, Kerala, India (Araneae). Eur Arachnol 2005; 181–190.
40. Tahir HM and Butt A. Predatory potential of three hunting spiders inhabiting the rice ecosystems. J. Pest Sci 2009; 82: 217-225.
41. Thomson LJ. and Hoffmann AA. Natural enemy responses and pest control: Importance of local vegetation. Biol. Contr 2010; 52: 160-166. <https://doi.org/10.1016/j.biocontrol.2009.10.008>
42. Tikader BK. and Biswas B. Spider fauna of Calcuta and vicinity: Part 1 – Records of Zoological Survey of India 1981; Occasional papers, 30: 1-49.
43. Tikader BK. Studies on spider fauna of Andaman and Nicobar islands, Indian Ocean – Records of Zoological Survey of India 1977; 72: 153-212.





### Kannadasan and Senthil Kumar

44. Tiwari AK, Singh R. Diversity and distribution of Pisauridae (Araneae: Araneomorphae:Arachnida) in India. Int. J. Entomol. Res 2021; 6(1): 119-125.
45. Tyagi K, Kumar V, Kundu S, Pakrashi A, Prasad P, Caleb JT. and Chandra K. Identification of Indian Spiders through DNA barcoding: Cryptic species and species complex. Sci. Rep 2019; 9: 1-13. <https://doi.org/10.1038/s41598-019-50510-8>.
46. Uetz GW. Habitat structure and spider foraging. In: Bell SS, McCoy ED, Mushinsky HR (eds) Habitat structure: the physical arrangement of objects in space. Chapman and Hall, London 1991 ; pp 325–348.
47. Vijaykumar PBV. Spider Fauna Of Paddy Ecosystem In Selected Areas Of Tungabhadra Project In Karnataka. Journal Of Agricultural Sciences 2004; 17 (3): 584-585.
48. Vilbaste A. The spider fauna of Estonian mires. Eesti NSV Teaduste Akadeemia Toimetised, Koide Biologia 1980; 29:313–327.
49. Wankhade VW, Manwas NA, Rupwate AA and Raut NM. Diversity and abundance of Spider fauna at different habitats of University of Pune, Pune, M. S. India, Global Advanced Res. J. Environ. Toxicol 2012; 1(8): 203-210.
50. Weng CY. and Black C. Taiwanese farm workers' pesticide knowledge, attitudes, behaviors and clothing practices. Int. J. Environ. Health. Res 2015; 25: 685-696. <https://doi.org/10.1080/09603123.2015.1020415>
51. Xie X. and Yang SQ. A warning information system for rice disease based on Web GIS. 2018. 8th Int. Conf. Appl. Sci. Eng. Technol (ICASET 2018). Atlantis Press; 2018. <https://doi.org/10.2991/icaset-18.2018.19>

**Table 1. Check list of spider species in three different sites of Namakkal district during 2019 to 2020**

Family	Species	Site I	Site II	Site III	Total
		No. of Sp.	No. of Sp.	No. of Sp.	
Araneidae	<i>Argiope catenulate</i>	+ (14)	+++ (53)	++ (32)	99
	<i>Argiope anasuja</i>	++ (20)	++ (24)	+++ (49)	93
	<i>Argiope picta</i>	+++ (46)	+++ (41)	+++ (40)	127
	<i>Araneus ventricosus</i>	+++ (42)	++ (23)	+++ (45)	110
	<i>Araneus diadematus</i>	++ (27)	++ (30)	+++ (52)	109
	<i>Neoscona crucifera</i>	++ (23)	+++ (41)	++ (27)	91
Clubionidae	<i>Clubiona terrestris</i>	++ (18)	+ (6)	++ (16)	40
Gnaphosidae	<i>Sergiolus montanus</i>	+ (8)	-	+++ (41)	49
Hersiliidae	<i>Hersilia caudate</i>	+ (5)	++ (18)	+ (8)	31
Lycosidae	<i>Hogna aspersa</i>	++ (36)	+ (13)	++ (32)	81
Oxyopidae	<i>Peucetia viridans</i>	+ (9)	++ (16)	++ (17)	42
	<i>Oxyopes macilentus</i>	++ (16)	+++ (36)	-	52
Salticidae	<i>Telamonia dimidiata</i>	+++ (45)	-	+ (10)	55
	<i>Telamonia elegans</i>	++ (21)	-	+++ (48)	69
Sparassidae	<i>Heteropoda venatoria</i>	-	+++ (37)	++ (15)	52
	<i>Olios millet</i>	-	++ (18)	++ (16)	34
Tetragnathidae	<i>Tetragnatha elongata</i>	++ (13)	+++ (31)	+ (10)	54
	<i>Tetragnatha guatemalensis</i>	+ (6)	+ (8)	+++ (36)	50
	<i>Tetragnatha laboriosa</i>	++ (27)	+ (9)	+ (10)	46
					1284

+++ = highly presence, ++ = normal presence, + = low presence, - = absence







Table 2. Diversity index of spider diversity

Index	Site 1	Site 2	Site 3	Total
Number of Classes $N$	19	19	19	19
Richness $R$	17	16	18	19
Berger Parker Index $p_{imax}$	13.30%	13.10%	10.30%	9.90%
Shannon Entropy <sup>1</sup> $H$ (nat)	2.6727	2.6268	2.7382	2.8597
Shannon Entropy <sup>1</sup> $H$ (bit)	3.8559	3.7897	3.9504	4.1256
Number Eq. $^1D$ (TrueDiversity)	14.5	13.8	15.5	17.5
Shannon Equitability $H/\ln N$	90.80%	89.20%	93.00%	97.10%
Simpson Dominance $SD$	7.80%	8.00%	7.20%	6.20%
$SD$ (unbiased - finitesamples)	7.50%	7.80%	7.00%	6.10%
True Diversity $^2D$ (Order2)	12.8	12.5	14	16.2
Gini-Simpson Index $1-SD$	92.20%	92.00%	92.80%	93.80%
Gini-Simpson Equitability	<b>97.30%</b>	<b>97.10%</b>	<b>98.00%</b>	99.00%

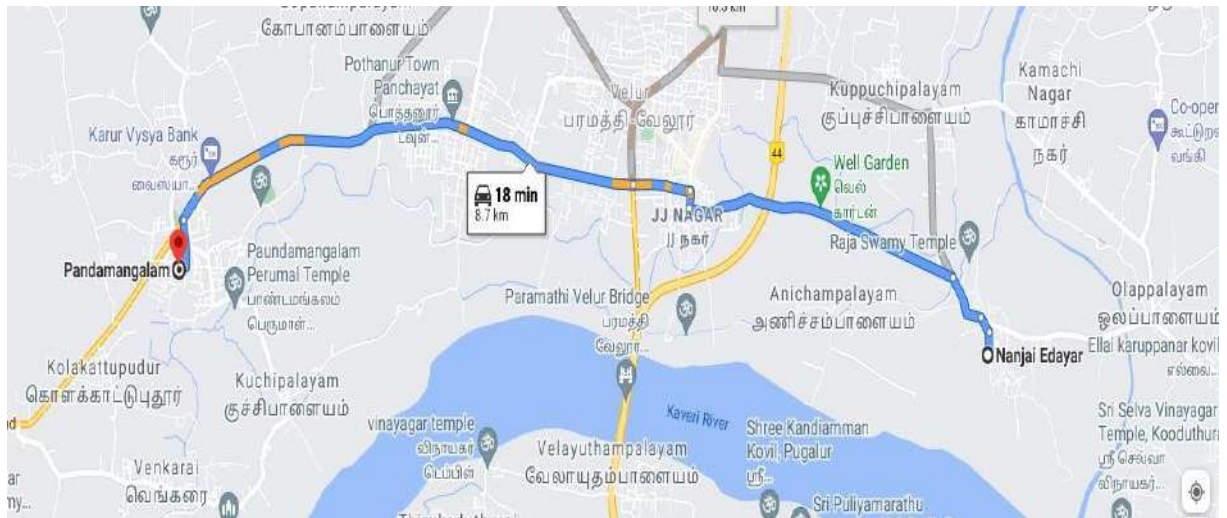


Fig. 1. Selected Study Area for Spiders diversity





Kannadasan and Senthil Kumar

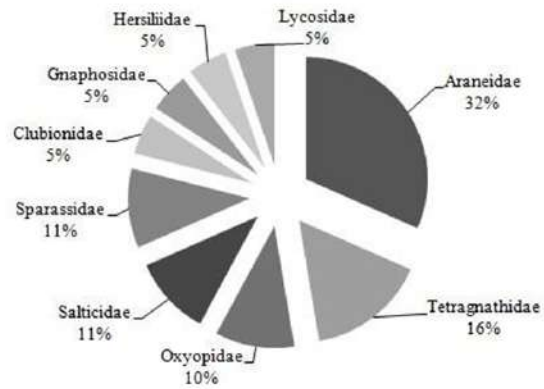


Fig. 2. Percentage composition of the different classes of Spiders – Pie chart

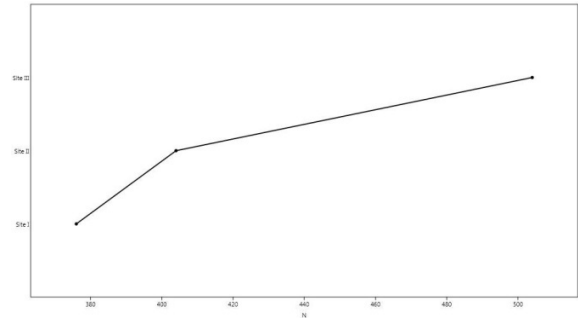


Fig. 3. Dominance Plot in all the selected study areas



Fig 4. Araneidae family *A. catenulata* (Fig. 4a), *A. anasuja* (Fig. 4b), *A. picta* (Fig. 4c), *A. ventricosus* (Fig. 4d), *A. diadematus* (Fig. 4e) and *N. crucifera* (Fig. 4f)

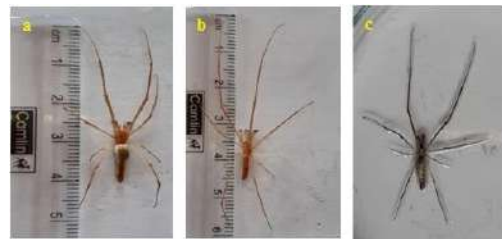


Fig 5. Tetragnathidae family - *T. elongate* (Fig 5a), *T. guatemalensis* (Fig 5b) and *T. laboriosa* (Fig 5c)



Fig. 6. Salticidae family *T. dimidiata* (Fig 6a), *T. elegans* (Fig 6b)



Fig. 7. Sparassidae family *H. venatoria* (Fig 7a), *O. millet* (Fig 7b)





Kannadasan and Senthil Kumar



Fig. 8. Oxyopidae family *P. viridans* (Fig 8a), *O. macilentus* (Fig 8b) Fig. 9. Clubionidae family (*C. terrestris*)



Fig. 10. Gnaphosidae family (*S. montanus*) Fig. 11. Hersiliidae family (*H. caudate*) Fig. 12. Lycosidae family (*H. aspersa*)

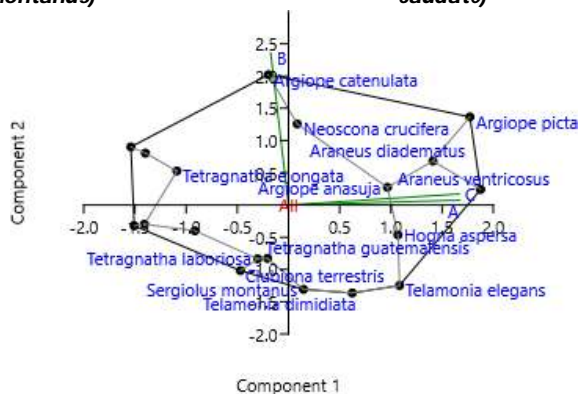


Fig. 13. The principal component plot of Sites I and II

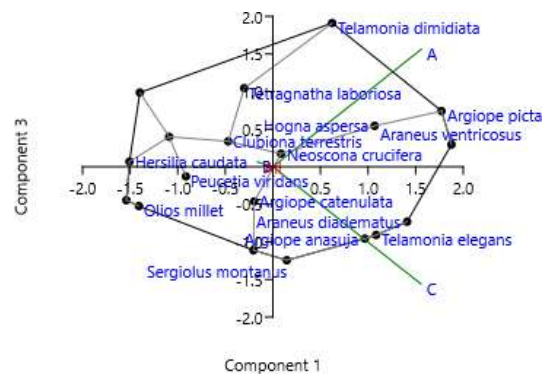


Fig. 14. The principal component plot of sites I and III





## Ethno Medicinal Plants used to Treat Skin Diseases by the Irula Tribal of Kozhikarai Village, Kotagiri, the Nilgiris, Tamil Nadu, India

Nahendran. C<sup>1\*</sup> and Kumarasamy. D<sup>2</sup>

<sup>1</sup>Research Scholar, Dept. of Botany, Annamalai University, Chidambaram, Tamil Nadu, India.

<sup>2</sup>Professor, Dept. of Botany, Annamalai University, Chidambaram, Tamil Nadu, India.

Received: 03 Dec 2021

Revised: 31 Dec 2021

Accepted: 24 Jan 2022

### \*Address for Correspondence

**Nahendran. C**

Research Scholar,

Dept. of Botany,

Annamalai University, Chidambaram,

Tamil Nadu, India.

Email: gainahen76@gmail.com



This is an Open Access Journal / article distributed under the terms of the **Creative Commons Attribution License** (CC BY-NC-ND 3.0) which permits unrestricted use, distribution, and reproduction in any medium, provided the original work is properly cited. All rights reserved.

### ABSTRACT

The present study is about the plants used in the treatment of skin diseases among the indigenous communities of Irula Tribal, Kozhikarai village, Kotagiri, the Nilgiris, Tamilnadu. Skin Diseases are common in most of the tropical areas especially among the tribal people who living in forest area due to lack of sanitation, awareness of hygienic food habits. The medicinal plants used by the tribal people to treat skin disorders such as cuts, wounds, boils, burns and leucoderma and various skin diseases. The ethno medicinal information was gathered from the traditional healer of kozhikarai village.

**Keywords:** Ethno medicine, Irula tribes, Nilgiris, Skin diseases.

### INTRODUCTION

India is considered as one of the 12 mega biodiversity countries of the world having about 45000 vascular plants, with concentrated hotspots in the regions of Eastern Himalayas, Western Ghats and Andaman and Nicobar Islands. The ethno medicines system of India use about 5000 plant species with about, 25000 formulations for treating the diseases whereas the medicinal plant of the word used over 8000 wild plants and about 1,75,000 specific preparations and applications (Divya and kalaichelvi 2016). Thousands of plants species used by human being during their importance of the health economy, shelter clothing and food. The traditional knowledge of medicinal plants has based on such as Ayurveda, Siddha, and Unani. According to World Health Organisation more a than 80% of the people are depends on traditional medicine for their primary health care. In India 75% of population relies on traditional medicine for their primary health care needs (Rizwana *et al* 2006.) The people of various parts of India are highly depending on medicinal plants used for the health care needs. In Ministry of tribal affairs presented a list of tribal communities in India for each state and Tamil nadu contains 36 types of tribal communities and they are



**Nahendran and Kumarasamy**

distributed in different district in the forest and adjoin areas (Dhivya and kalachelvi 2016). Western Ghats of Tamilnadu is ethno botanically very rich in having more diversity of medicinal plants. The Nilgiri hills referred to as “ the blue mountains” lies between 11° 12' to 11° 43' North to 76° 14' and 77° 1' East in the Western Ghats of Tamil nadu. The hills are part of mountain ranges, spanning an area of 2,543 sq. km. The general topography of the area consists of undulating hills and elevated hands with elevation varying from 350 to 2,623 m above sea level. It is characterized by rich and diversified flora and fauna distributed over the tropical to temperate zones (Sharma *et al* 1977, Logesh *et al* 2017).

The present study is about healing potential of plant species used to cure skin diseases by Irula tribal habit in the forest area in kozhikarai, kotagiri, the Nilgiri, Tamil nadu, India. The present study is about healing potential of plant species used to cure skin diseases by Irula tribal habit in the forest area in kozhikarai, kotagiri, the Nilgiri, Tamil nadu, India.

**MATERIALS AND METHODS****Study area**

The Irula tribal the hilly region of Kozhikarai village lies between 11° 16' and 11° 23' North and 77° 0' and 77° 27' East Kotagiri, the Nilgiris, Tamilnadu. The study area comes under kotagiri panjayat. Ethno medical information was collected from tribal settlements of this area, the elderly person who have knowledge of employing plants as medicine in folk therapy was interviewed. Data were also collected through questioner in their local language. In addition to the local names and medicinal uses of plants a detailed information about the mode of preparation of various medicines was also collected from the tribal people. The medicinal plants were identified and photographed and samples of specimens were collected for the preparation herbarium. The herbarium sheet prepared from the specimens were deposited in the department herbarium.

**RESULT AND DISCUSSION**

A total number of twenty eight plant species of twenty three families have been documented (Table -1). The Asteraceae, Amaranthaceae, Poaceae, Verbenaceae and Zingiperaceae are each two species are adequately used in the mode of preparation of ethno medicine and other families have only one species each. Regarding the parts used for medicine preparations includes fresh leaves, flower, stem, bark, fruit and whole plant (Fig -1). In the mode of preparation of mostly paste form is used compared to powder, decoction, juice and raw methods (Fig -2). Table -1 and Fig -2 depict the list of twenty eight plant species of twenty three families to treat skin diseased by Irulas. It was observed from the present investigation that the leaf paste of *Acorous calamus*, *Achyranthus aspera*, *Azardirachta indica*, *Chenopodium ambrosoides*, *Datura metel* were used to treat skin diseases. Ayyanar and Ignachimuthu (2004), have reported 14 plants for the treatment of skin diseases among these 14 plants ten plants *Aloe vera*, *Azardirachta india*, *Baihinia purpurea*, *Cleodendran serratum*, *Cynodon dactylon*, *Dature metal*, *Hibiscus rosa-sinensis*, *Justicia diffusa*, *Ocimum sanctum* and *Piper bettle* were observed in the present investigation also similarly used for skin diseases. Sharma laxmikant (2003) have listed 13 plants for the treatment of skin diseases among there 6 medicinal plants were observed in the present investigation. Suresh (2003) have recorded that leaves of *Azardirachta indica* is used for the treatment of leucoderma similarly the irula tribal people also used leaves of *Azardirachta indica* for treating leukoderma diseases. The kani tribals used tuber of *Gloriosa superba* to treat skin diseases from aravali hills, Rajasthan. (Katewa 2003). Divya and Kalaichelvi (2016) reported 37 plants used for skin diseases in the karamadai range, Western Ghats, among these five medicinal plants like *Ageratum conyzoides*, *Aloe vera*, *Azardirachta indica*, *Ipomea cornea*, *Jatropha curcus* were also observed in the present investigation. Ignachimuthu (2008) reported 15 plants used by the tribals for the treatment of Skin diseases, among these 15 plants 10 plants *Aloe vera*, *Azardirachta indica*, *Baihinia purpurea*, *Clerodendrum serratum*, *Cynodon dactylon*, *Datura metal*, *Hibiscus rosa-sinensis*, *Justicia diffusa* *Ocimum sanctum* and *Piper bettle* were observed in the present investigation.





### Nahendran and Kumarasamy

## CONCLUSION

The present study is about the herbal remedies is used by the the irula people of kozhikarai village, kotagiri, the Nilgiris for the various skin disorders. The skin problems disorder includes Itches, Eczema ,Boils, Leprosy and Leucoderma. Herbal medicines preparation include pastes and powders and some even used as fresh raw plants.

## ACKNOWLEDGEMENT

We express our sincere thanks Dr. K.C. Ravindran, Professor and Head, Department of Botany, Annamalai University, Chidambaram, Tamilnadu for providing necessary facilities to carry out this study. Authors are also thanks to the tribal people of Irulas those who are shared the valuable traditional knowledge to us.

## REFERENCES

1. Dhivya SM & Kalaichelvi K. Ethno medicinal plants used to treat skin disease and Poisonous bites by the tribals of Karamadai range, Western Ghates, Tamil nadu, India. *International Journal of Plant, Animal and Environmental Sciences* 2016: **6**(3): 53-8.
2. Qureshi RA, Ahmed I & Ishtiaq M. Ethnobotanical and phytosociological studies of tehsil Gujar Khan district Rawalpindi. *Asian J Plant Sci*, 2006: **5**(5): 890-893.
3. Logesh R, Dhanabal SP, Duraisamy B, Chaitanya M, DhamodaranP, and Rajan S . Medicinal plants diversity and their folklore uses by the Tribes of Nilgiri Hills, Tamilnadu. *Int.J. of Pharmacognosy and Chinese med.* 2017:Vol - **1**(3):000114.
4. Jain SK. *Plants in Indian medicine and folklore associated with healing of bones.* (1967).
5. Rajan S, Sethuraman M & Mukherjee PK. Ethnobiology of the Nilgiri hills, India. *Phytotherapy Research: An International Journal Devoted to Pharmacological and Toxicological Evaluation of Natural Product Derivatives.* 2002: **16**(2): 98-116.
6. Sharma BD, Shetty V, Vajravelu E, Kumari GR, Vivekanathan V, Chandrabose,M & Subbarao GV. (1977). Studies on the flora of Nilgiris, Tamil Nadu. *Biological memoirs.* 1977.
7. Ayyanar M and Ignacimuthu S. Medicinal plants used by the tribals of Tirunelveli hills, Tamil Nadu to treat Poisonous bites and skin diseases. *India J. Traditional Knowledge.* 2004: **4**(3): 229 – 236.
8. Sharma Laxmikant, Agarwal Gaurav and KUMAR Ashwini. Medicinal plants for skin and hair care. *Indian J. Traditional knowledge.* 2003: **2**(1): 62 – 68.
9. Suresh K, Goyal S and Praveen F. Ethnomedicobotany of household remedies of Kolayat tehsil in Bikaner district, Rajasthan, *Indian J. Traditional Knowledge.* 2003: **2**(4): 357 – 365.
10. Ignacimuthu S, Ayyanar M and Sankarasivaraman K. Ethnobotanical study of medicinal plants used by Paliyar tribals in Theni district of Tamilnadu, India. *Fitoterapia.* 2008 :**79**: 562-568.
11. Katewa SS, Chandhary BL, Jain Anita and Galav Praveen. Traditional uses of plant biodiversity from Aravali hills of Rajasthan. *Indian J. Traditional Knowledge.* 2003: **2**(1): 27 – 29.

**Table -1: List of plants used for the treatment of skin diseases**

BOTANICAL NAME	FAMILY	LOCAL NAME	PARTS USED	MODE OF PREPARATION	MODE OF USES	AILMENTS
<i>Acorus calamus</i> L.	Araceae	Vasambu	Rhizome	Paste	External	Eczema, Leprosy
<i>Achyranthus aspera</i> L.	Amaranthaceae	Nayuruvi	Root	Paste	External	Burn, Leprosy
<i>Ageratum conyzoides</i> L.	Asteraceae	Appakodi	Leaf	Decoction	Internal	Cuts, Wounds
<i>Aloe vera</i> L.	Liliaceae	Kathalai	Leaf	Paste with cumin seeds	Internal	Leprosy
<i>Annona squamosa</i> L.	Annonaceae	Seetha palam	Fruit	Raw	Internal	Eczema
<i>Areca catechu</i> L.	Arecaceae	Paakku	Seed	Paste	External	Small pox





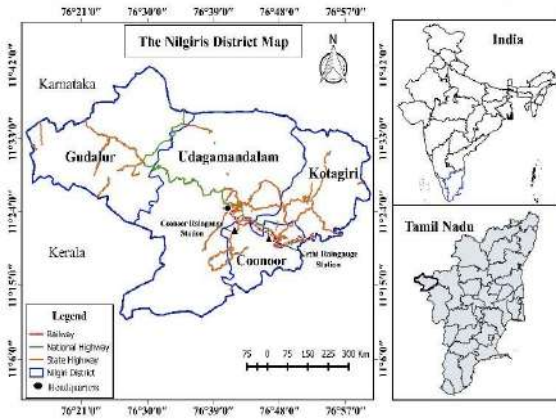
## Nahendran and Kumarasamy

<i>Azadirchta indica</i> Juss.	Meliaceae	Vembu	Leaf and Flower	Paste	External	Itches, Wounds, Leucoderma
<i>Bambusa arundinacea</i> (Retz) Roxb.	Poaceae	Moongkil	Shoot	Paste	External	Eczema
<i>Bauhinia tomentosa</i> L.	Fabaceae	Iruvachi	Leaf, Flower and Stem	Decoction	Internal	Cuts, Wounds
<i>Carica papaya</i> L.	Caricaceae	Pappali	Fruit	Raw	Internal and External	Skin diseases
<i>Chenopodium ambrosoides</i> (L).Mosyakin & clemnts	Amaranthaceae	Nara Keerai	Leaf	Paste	External	Skin diseases
<i>Clerodendrum serratum</i> (L).Moon	Verbenaceae	Siruthekku	Leaf	Paste	Internal	Skin diseases
<i>Curcuma aromatica</i> . Salish	Zingiberaceae	Kasthuri manjal	Rhizome	Powder, Paste with <i>Terminalia cebula</i>	External	Impetigo
<i>Curcuma longa</i> L.	Zingiberaceae	Manjal	Rhizome	Powder, Paste	Internal and External	Leprosy
<i>Cyanodon doctylon</i> (L).	Poaceae	Arugampul	Leaf	Powder, Paste	Internal and External	Skin diseases, Blood purifier
<i>Datura metel</i> L.	Solanaceae	Oomathai	Seed	Paste	External	Eczema
<i>Hibiscus rosa sinensis</i> L.	Malvaceae	Sembaruthi	Leaf	Raw, Paste, Decoction	Internal	Skin diseases, Itching
<i>Ipomea carnea</i> Jacq.	Convolvulaceae	Speaker poo	Leaf	Paste	Internal and External	Healing of wounds
<i>Jatropha curcus</i> L.	Euphorbiaceae	Kattamanaku	Leaf	Paste	External	Burns
<i>Justicia diffusa</i> L.	Acanthaceae	kodasoori	Leaf	Paste	Internal and External	Skin diseases
<i>Lawsonia inermis</i> L.	Lythraceae	Maruthani	Leaf	Paste	External	Burns
<i>Ocimum sanctum</i> L	Lamiaceae	Thulasi	Leaf	Raw, Paste	Internal and External	Leprosy, Cuts, Wounds
<i>Piper beetle</i> L.	Piperaceae	vetrillai	Leaf	Paste with <i>Allium sativum</i>	External	Cuts, Wounds, Leprosy
<i>Portulaca oleracea</i> L.	Portulacaceae	Tharai keerai	Leaf	Paste, Decoction	Internal and External	Leprosy
<i>Rubia cardifolia</i> L.	Rubiaceae	Savalikodi	Leaf	Paste	External	Skin diseases
<i>Sauropus androgynous</i> L.	Phyllanthaceae	Thavasi mugungai	Leaf	Powder, Paste	Internal and external	Skin diseases
<i>Tridex procumbans</i> .L.	Asteraceae	Vettukaya poondu	Leaf	Paste	External	Cuts, Wounds
<i>Vitex negundo</i> L.	Verbenaceae	Nocchi	Whole Plant	Paste	External	Leprosy

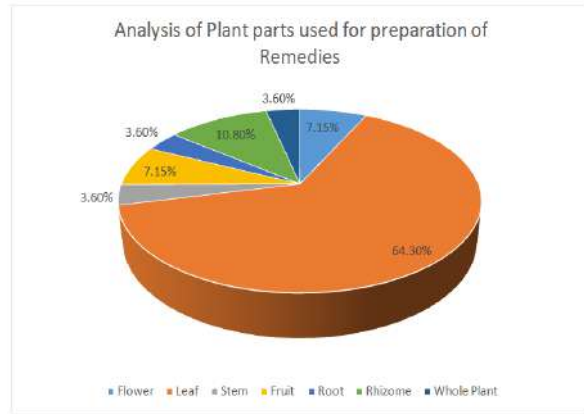




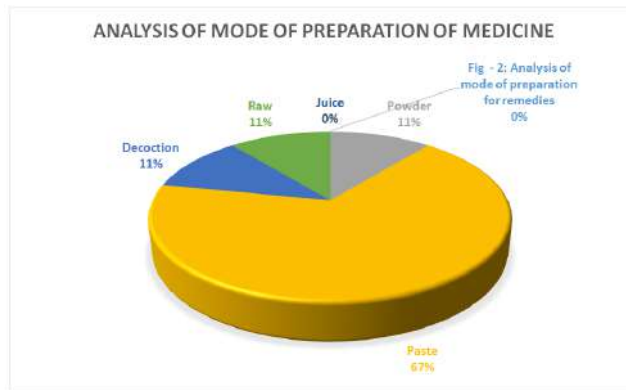
**Nahendran and Kumarasamy**



**Fig 1. Nilgiri and kotagiri map**



**Fig 2. Analysis of plant parts used for preparation of medicine**



**Fig 3. Analysis of mode of preparation of medicine**







## Exploring the Virtual Water Productivity in Feed and Fodder Crop Production in Rajasthan

Priya Modi<sup>1</sup> and Shilpi Gupta<sup>2\*</sup>

<sup>1</sup>Research Scholar, Department of Economics, Manipal University Jaipur, Rajasthan-303007, India.

<sup>2</sup>Associate Professor, Department of Economics, Manipal University Jaipur, Rajasthan -303007, India.

Received: 09 Nov 2021

Revised: 12 Dec 2021

Accepted: 11 Jan 2022

### \*Address for Correspondence

#### Shilpi Gupta

Associate Professor,  
Department of Economics,  
Manipal University Jaipur,  
Rajasthan -303007, India.  
Email: guptashilpi09@gmail.com



This is an Open Access Journal / article distributed under the terms of the **Creative Commons Attribution License** (CC BY-NC-ND 3.0) which permits unrestricted use, distribution, and reproduction in any medium, provided the original work is properly cited. All rights reserved.

### ABSTRACT

The study aims to explore the virtual water productivity of feed and fodder crops produced in different regions of Rajasthan for giving a sustainable policy implication to the policymakers in order to achieve SDG of Responsible production and consumption and also to maintain the food security and water scarcity nexus. The studies so far in this area has not taken the concept of virtual water which combines both blue and green water use, especially in the state like Rajasthan for the feed and fodder crops. This study is to explore the use of virtual water and to estimate the virtual water productivity of selected crops of selected regions in the state. The state has higher incentives in carrying on the production of maize, bajra, mustard, guar and groundnut. For the rest the state should engage in the virtual water trade with neighboring states.

**Keywords:** virtual water, virtual water productivity, water intensive techniques, water scarcity

### INTRODUCTION

Rajasthan has always been a major agrarian economy in India, due to its spatial and temporal variations in agriculture, water, population and livestock. Rajasthan is highest producer of rapeseed, mustard and bajra and is also engaged in production of wool, jowar, guar, groundnut etc. This state faces the greatest scarcity of water resources with only 1.16 % of surface water and 1.70 % of ground water for the 13.88 % cultivable area, about 11 % of livestock and 5.67 % of country's population. The state has highest population of buffalo and 6<sup>th</sup> highest population of cattle in India, making a more than 14.42 percent of annual growth rate in milk production. Dairy industry in Rajasthan reports that buffalo milk dominates the total milk production. The increase in milk production directs





### Priya Modi and Shilpi Gupta

towards increasing production of feed and fodder at local level in order to avail more profit and related incentives from mulching animals. Feed and fodder constitute about 60-70 percent cost of milk production (Devendra Kumar Meena, 2017). Due to its strategic location in India, it is an attractive market for the northern and western states, since Rajasthan shares boundaries with the five states (Uttar Pradesh, Madhya Pradesh, Gujarat, Punjab, and Haryana). As per the Composite Water Management Index 2017-18, given by NITI Aayog, Rajasthan is the low performing state with the score of 47. Per capita annual water availability in the state is about 780 cubic meter against minimum requirement of 1000 cubic meter and it is estimated to fall below 450 cubic meter by the year 2050. According to Falken mark Indicator, a most commonly used measures of water scarcity, states that if the water availability per person per year in a country is below 1000 cubic meter then it is experiencing water scarcity and so is the Rajasthan (Singh, 2004). Out of total desert areas in India, 85 regions are in the state of Rajasthan which aggravates the water crisis. Only 32 blocks of state are in the safe category of ground water level, this calls for an immediate remedy measures on conserving groundwater.

Year	Rajasthan (m <sup>3</sup> )	India (m <sup>3</sup> )
1951	2028	6602
1971	1725	4349
1991	1042	2829
2000	857	2384
2025	567	1589

Source: Water resources vision 2045. Irrigation Department. GOR

As per last State Water Policy, total surface water available in the State is 21.71 billion cubic meter (BCM), out of which 16.05 BCM is economically utilizable, so far state has harnessed 11.55 BCM, rest is allocated through the inter-state water agreements. The availability of water in the state does not commensurate with the requirements of water (Department, 2008). This state has to largely depend upon the inter-state water sharing agreements as rainfall is very scanty, monsoon is for two months only which is also now delayed with the climatic change. In Rajasthan also the southern and south-eastern districts are only water rich regions with the availability of rainfall.

These zones have been classified on the basis of agro-climatic parameters like rainfall, temperature, soil profile, cropping pattern and irrigation facilities ((DOA), 2013, 2014, 2015, 2016, 2017, 2018, 2019, 2020). Rajasthan is also divided politically into seven divisions, each having more or equal to four districts. For this study we have selected each district for each division, for exploring the virtual water use in the feed and fodder crop production. As the state has second largest livestock population in which buffalo, cow, goat and sheep are in maximum number. These animals are also recognized as the dairying animals, as the milk is produced by cattle, buffalo and goat in Rajasthan. (O P Singh, 2004), For the milk production, livestock is fed with the appropriate feed and fodder. For feed and fodder the state produces certain number of rabi and kharif crops annually. This study explores the production of those crops in the selected seven districts belonging to different agro-climatic situations. (Sharma, 2013), the water productivity depends upon the concept of "more crop per drop" or "producing more food from the same water resources". People who are responsible for managing the water resources tend to be more concerned with the total water input in farming.

Farmers belonging to the arid regions are more concerned about the rainfall and the irrigation of farms with less available water. The productivity of water in this study is calculated in relation with the crop yield out of the given irrigation. 'Virtual water', is the hidden amount in the production, in the context of crop it has two components: blue and green. Blue water is quantified through the tube wells runoff and green water is of the rainfall. Both blue and green water accumulate to form the virtual water used in the crop production (Ashok K. Chapagain, 2003), (Hoekstra, 1993). Feed and fodder are in a way by-products of the final crop produced in any region, the water used up in the production cycle of a crop is same for the fodder production. The food grain is filtered out of the total produce and the rest is left out for the dry fodder and while growing stage of a crop, cutting takes place in order to assemble green fodder for the animals. The water intake by any crop, whether it is rainfed or irrigated, is same as the requirement is the same in both the patterns of cultivation. Many researchers have done the study for calculating the





### Priya Modi and Shilpi Gupta

productivity of a crop in terms of area but in terms of water it is not done in the regions of Rajasthan. This study aimed to estimate and explore the virtual water use and its productivity in order to fill the research gap.

#### OBJECTIVES AND METHODOLOGY

The objective of this paper are to: (i) explore the total production and yield of selected feed and fodder crops. (ii) quantify the total virtual water use in the crop production (iii) estimate the crop water productivity in seven different regions of Rajasthan. The study covered seven districts from seven divisions, each district from each division respectively. These districts are Ajmer, Bharatpur, Ganganagar, Jaipur, Jodhpur, Kota and Udaipur. This study included the study of eleven crops which are used as feed and fodder, these crops are gram, barley, bajra, jowar, maize, wheat, paddy, soyabean, groundnut, guar and mustard. The study is secondary data and primary data based. From each district one livestock rearing farmer was interviewed telephonically. The data is collected for the period of 2015-16 to 2019-20 from the annual reports of Rajasthan Agricultural Statistics, Department of Agriculture (DOA), Government of Rajasthan (GOR).

Ajmer and Jaipur are politically from different divisions but as per agro-climatical zones both fall in the same category of semi arid eastern plains. This zone receives rainfall about 500-700mm, drained by the river Banasand its tributaries. Ganganagar is in the Irrigated North Western plains, this zone is irrigated with the network of Indira Gandhi Canal and the Ghaggar river. Bharatpur is in the Flood prone Eastern plains, which is recipient of 600-700mm rainfall. The zone has deposits of Yamuna river and Indo-Gangetic Plains. Jodhpur fall in the Arid North Western Sandy Plain zone, receives 100-400mm mean annual rainfall. The groundwater in this region is deep and saline but in few regions tubewells are used for irrigation. The livelihood in this region is majorly livestock based. Kota is from the Humid south-eastern plain, receives 700-1000mm rainfall. This zone receives the highest rainfall in the state. Udaipur is the last selected district, is in the Sub-humid southern plain and Aravalli hills. This zone receives 700-900mm rainfall. The land of this zone is rich for cultivation.

Crops considered for evaluating the virtual water productivity of feed and fodder crop are wheat, barley, gram, mustard, bajra, guar, jowar, soyabean, groundnut, maize and paddy. Green fodder comprise of maize, jowar and alfalfa. Due to some reasons government department do not account the statistics for Alfalfa and other green fodder crops, as majorly they are grown locally by the dairy farmers. Dry fodder consists of wheat straw, paddy straw, bajra straw, jowar straw and groundnut straw. In the concentrate seeds of soyabean, groundnut cake, guar seed cake and maize are mixed in certain equal proportion fulfilling the nutrient requirement of the animals feed. According to the DOA, dry fodder formula for the selected crops are as follows:

The following formulations used in the study for virtual water productivity of feed and fodder crops are:

Total water used ( $m^3$ ): Number of irrigation in whole lifecycle of crop \* Hours of irrigation \* Pump discharge

Virtual Water productivity (VWP) for crop production ( $kg/m^3$ ): Crop yield ( $kg/ha$ )/Total water used ( $m^3$ )

Following are the graphs for individual crops used for feed and fodder

#### RESULTS AND DISCUSSIONS

As per the graph in figure 1, VWP of the crops, jowar, soyabean, paddy and wheat is in declining trend. Wheat, paddy and soyabean are crops which have highest water intake and resulting in the less productivity. VWP of maize is seen falling after 2018-19, although it is still higher than the VWP of paddy and wheat. Soyabean, wheat and paddy are water guzzling crops, consumes more water, resulting in less cost efficiency for the related farmers. Paddy in Jodhpur and Udaipur is giving least VWP, on the other side it is increasing in trend in Bharatpur after 2017. In the flood prone region it has witnessed a fall after 2018 to 16 kg per cubic meter from 18 kg per cubic meter. Wheat has an increasing trend after 2017, soyabean had a steep fall from the mid-period of 2018 from around 8 kg per cubic meter to around 2 kg per cubic meter in every district, there is negligible VWP in Jodhpur, Bharatpur and Ganganagar, highest is in the humid region Kota. There is steep fall in productivity of Gram in Bharatpur after 2017



**Priya Modi and Shilpi Gupta**

from 20 to 10 kg per cubic meter, it is highest in Kota. Barley has increasing productivity in all seven districts with highest in the Ganganagar and lowest in the Udaipur. Lowest productivity of Guar is in Udaipur and Kota with less than 2 kg per cubic meter, the highest VWP is in the Bharatpur, Jaipur and Ajmer. There is a strategic increase in the VWP of guar in Jodhpur. Fall in VWP of jowar in all districts after 2018 till 2020, lowest is in Udaipur and high in the Jaipur and Bharatpur. Oilseeds like groundnut, rape and mustard states an higher VWP in Ganganagar, Bharatpur, Kota, Jaipur and Jodhpur. Maize shows very fluctuating trend with fall in Kota to zero from 60, increase in Bharatpur from zero to 20 kg per cubic meter after 2018.

**CONCLUSIONS AND POLICY IMPLICATIONS**

Rajasthan has incentives in continuing the production of Maize as it needs least amount of water to grow, jowar cultivation is highly water intensive with very low VWP and also it used as concentrate only, cultivating groundnut is very beneficiary in the state as it is kharif crop so it is highly rainfed and depends less upon the blue water irrigation. Also groundnut is used as both dry fodder and concentrate and the grain is also produces in a greater number. For the rest of the feed and fodder crops or could be the other cereal or pulses, state should engage into less water intensive techniques like drip irrigation and sprinkler system. There is a need of deep research in agricultural science as in crop like gram, drip irrigation technique is less effective. In a state like Rajasthan, crop cultivation should be carried with traditional farming methods where less water was used. Now a days many type of fertilizers are available in the market which allow the higher production with less water but in return less amount of nutrients are in the crop or foodgrains then. So the state should engage in the virtual water trade by importing highly water intensive feed and fodder crops and also the concentrate of higher water content from the neighboring states who have incentive in producing the same crops. The state can export virtual water in terms of the fodder if it has higher efficiency in producing that particular crop.. This study is the first part of its series and with the other factors like economic water productivity and the water scarcity index there is higher scope so we will try to bring different factors in the addition to this study.

**REFERENCES**

1. (DOA), D. o. (2013, 2014, 2015, 2016, 2017, 2018, 2019, 2020). *Rajasthan Agricultural Statistics at a glance*. Government of Rajasthan .
2. Ashok K. Chapagain, A. Y. (2003). *Virtual Water Trade: A quantification of virtual water flows between nations in relations to international trade of livestock and livestock products*. Value of Water Research Report Series .
3. Department, I. (2008). *Water resources vision 2045*. Government of Rajasthan.
4. devendra kumar meena, g. s. (2017). Knowledge of farmers about improved fodder production practices in Rajasthan state of India . *International journal of Current Microbiology and Applied Sciences*, 2013-2025.
5. Hoekstra, A. Y. (1993). *Virtual water: An introduction, Virtual water trade*. Netherlands: Value of Water Research Report Series, International books.
6. P Singh, A. S. (2004). Virtual water trade in dairy economy: Irrigation water productivity in Gujarat. *Economic and Political Weekly*, 3492-3497.
7. Sharma, P. (2013). Productivity Based Allocation of Water for Irrigation in Rajasthan. *Memoir geographical society of India*, 181-196.
8. Singh, O. P. (2004). Water productivity of milk production in North Gujarat, Western India. *International Water Management Institute*.





**Priya Modi and Shilpi Gupta**

**Table 4: Agro-climatic zones of Rajasthan**

Zone No.	Name of zone	Area (million ha.)	Districts covered
I-A	Arid western plain	4.74	Bikaner, Churu, Parts of Jodhpur, Jaisalmer, Barmer
I-B	Irrigated North Western Plain	2.10	Ganganagar, Hanumangarh
I-C	Hyper Arid Partially Irrigated Western Plain Zone	7.70	Bikaner, Jaisalmer and Parts of Churu
II-A	Transitional Plain of Inland Drainage	3.69	Jhunjhunu, Nagaur, Sikar
II-B	Transitional Plain of Luni Basin	3.00	Jodhpur, Pali, Sirohi
III-A	Semi-Arid Eastern Plain	2.96	Ajmer, Jaipur, Tonk, Dausa
III-B	Flood Prone Eastern Plain	2.72	Alwar, Bharatpur, Dholpur, Karauli, Sawai Madhopur
IV-A	Sub-Humid Southern Plain and Aravalli Hills	3.16	Bhilwara, Rajsamand, Udaipur, Chittorgarh
IV-B	Humid Southern Plain	1.72	Banswara, Dungarpur
V	Humid South-Eastern Plain	2.76	Bundi, Kota, Baran, Jhalawar

**Table 5: Dry fodder formula respective to main crop yield**

Crop	Dry fodder content of the yield
Maize	Twice
Jowar	Twice
Groundnut	80 percent
Gram	80 percent
Wheat	80 percent
Paddy	80 percent
Soyabean	4 times
Barley	Equal
Guar	Twice
Rape & mustard	10 percent in concentrate
Bajra	Twice





**Priya Modi and Shilpi Gupta**

Table 6: Total Production (tonnes), Source: DOA, GOR.

District	Gram					Soyabean					Guarseed				
	2015-16	2016-17	2017-18	2018-2019	2019-2020	2015-16	2016-17	2017-18	2018-2019	2019-2020	2015-16	2016-17	2017-18	2018-2019	2019-2020
Ajmer	16423	125353	61422	86129	24495	13	1	1		1	10465	15415	13212	11131	12800
Alwar	6354	16298	14604	16654	19582	0	0	0	0	0	47732	32060	19935	15339	6303
Banswara	13236	13045	11748	16989	18157	42936	84552	82284	80459	57025	207	151	2	19	90
Baran	11739	24922	130884	77254	89422	155787	246590	209806	229651	134466	144	98	5	1	0
Barmar	91	1834	3057	320	874	0	1	0	0	0	80480	41561	71082	22166	146064
Bharatpur	2510	4912	2823	5753	3501	1	0	0	0	0	43630	20006	6261	6269	5103
Bhilwara	10523	37458	38512	62404	130794	7826	4005	5755	7404	2418	8223	12479	8108	7520	4397
Bikaner	222289	193588	234964	244478	226709	0	0	0	0	0	408082	341450	27828	192929	198111
Bundi	2664	10818	64815	35361	46915	80817	65123	34015	31254	22564	400	800	48	32	90
Chittor	5378	10645	25171	65872	100252	79678	96155	96669	139384	42847	4511	4175	4222	1787	2119
Churu	42048	76132	41017	65325	63771	0	0	0	0	0	86840	61230	77083	76240	67764
Dausa	12824	21826	13805	26415	33402	0	1	0	0	0	10863	14637	10575	10472	8865
Dholpur	916	884	759	718	732	0	0	0	0	0	666	1316	781	744	167
Dungarpur	10919	13827	14616	16720	20691	21832	35659	30053	45693	16031	1005	1348	585	879	255
Ganganagar	80398	90360	98909	88269	113395	3	0	0	0	0	563897	253164	222773	184785	175089
Hanumangarh	48697	74050	66500	106885	163588	4	0	0	0	0	199844	130168	144829	148255	135668
Jaipur	12939	105101	25797	88884	152151	2	6	1	1	1	50226	59166	50122	45120	53244
Jaisalmer	132675	136888	125620	181000	154241	0	0	0	0	0	203745	58866	81593	26811	94435
Jalore	1183	19741	31497	424	9312	0	0	0	0	0	18134	21768	16336	4927	25118
Jhalawar	9977	22357	88810	78026	84244	140960	228049	282412	271821	68954	7	3	1	1	0
Jhunjhunu	50244	71248	79100	118035	103918	0	0	1	1	0	89370	58569	59486	59486	48543
Jodhpur	4583	17956	28298	41675	68218	0	0	0	2	0	137167	109338	56005	56005	125829
Karoli	2656	13712	3295	17006	24727	8	2	12	5	2	7104	4725	2651	2651	2172
Kota	3488	13726	77531	62189	83364	145442	167544	150550	150568	115752	59	31	3	3	0
Nagpur	7874	38604	21025	24790	152915	1	2	0	1	1	87130	50908	58430	58430	70401
Pali	26764	100475	136598	21956	158543	1	2	17	13	2	35997	11540	14313	14313	13136
Pratapgarh	17574	20953	22128	34802	42307	109923	173559	154689	179554	45268	0	22	13	13	11
Rajsamand	501	883	1454	1649	4017	37	68	235	518	222	1272	4054	3770	3770	2656
S. Madhopur	12243	28446	58868	66805	89966	11007	16124	5570	2278	1867	6420	3591	1464	1464	915
Sikar	39222	39188	42906	68067	78892	0	2	0	9	0	91295	72189	57124	57124	69276
Sirohi	2207	3645	2659	626	3941	0	4	2	0	0	15792	8790	7232	7232	11315
Tonk	19678	48107	107956	106348	156153	418	550	140	58	42	4412	4453	3645	3645	1454
Udaipur	9537	12405	11245	12116	15053	7388	13826	17618	29895	17591	8265	6785	11852	11852	3453





Priya Modi and Shilpi Gupta

Jhunjhunu	50244	71248	79100	118035	103918	0	0	1	1	0	89370	58569	59486	59486	48543
Jodhpur	4583	17956	28298	41675	68218	0	0	0	2	0	137167	109338	56005	56005	125829
Karoli	2656	13712	3295	17006	24727	8	2	12	5	2	7104	4725	2651	2651	2172
Kota	3488	13726	77531	62189	83364	145442	167544	150550	150568	115752	59	31	3	3	0
Nagpur	7874	38604	21025	24790	152915	1	2	0	1	1	87130	50908	58430	58430	70401
Pali	26764	100475	136598	21956	158543	1	2	17	13	2	35997	11540	14313	14313	13136
Pratapgarh	17574	20953	22128	34802	42307	109923	173559	154689	179554	45268	0	22	13	13	11
Rajsamand	501	883	1454	1649	4017	37	68	235	518	222	1272	4054	3770	3770	2656
S. Madhopur	12243	28446	58868	66805	89966	11007	16124	5570	2278	1867	6420	3591	1464	1464	915
Sikar	39222	39188	42906	68067	78892	0	2	0	9	0	91295	72189	57124	57124	69276
Sirohi	2207	3645	2659	626	3941	0	4	2	0	0	15792	8790	7232	7232	11315
Tonk	19678	48107	107956	106348	156153	418	550	140	58	42	4412	4453	3645	3645	1454
Udaipur	9537	12405	11245	12116	15053	7388	13826	17618	29895	17591	8265	6785	11852	11852	3453

District	Groundnut					Jowar					Maize				
	2015-16	2016-17	2017-18	2018-2019	2019-2020	2015-16	2016-17	2017-18	2018-2019	2019-2020	2015-16	2016-17	2017-18	2018-2019	2019-2020
Ajmer	3440	2420	2089	1322	1657	45202	81569	74554	101153	90858	17624	28401	29316	38887	30091
Alwar	1823	1666	638	544	428	24418	20930	16248	23664	13400	5766	5583	5782	4323	4035
Banswara	341	434	505	548	577	144	195	170	183	147	133898	165712	186341	190121	126877
Baran	1183	2109	1936	1287	843	174	150	77	51	1102	24092	61512	61640	39991	8295
Barmer	5968	7366	5889	4675	8385	848	461	471	111	3924	41	8	30	18	28
Bharatpur	24	10	6	8	7	56019	34802	28622	43616	51971	11	2	4	0	1
Bhilwara	5917	8916	11031	16522	9368	12081	35496	40373	74450	64435	197736	265208	361784	382348	248191
Bikaner	402451	467358	514095	531099	529065	195	25	1196	356	152	0	2	0	0	0
Bundi	1043	908	761	678	810	53	101	58	100	714	86395	87396	79263	111752	28471
Chittor	11261	14171	30990	51068	19880	14046	12452	14430	22267	16060	196016	162063	325824	326152	206977
Churu	101199	134044	144687	178801	165529	0	1	0	3	15	0	0	2	0	0
Dausa	13406	13259	14551	18152	20856	4391	3913	3408	3616	3948	578	519	781	750	566
Dholpur	87	90	69	72	92	68	173	184	357	184	3	0	0	0	0
Dungarpur	34	88	53	66	53	139	121	133	206	150	57881	87492	70309	88143	65101
Ganganagar	3011	4971	8535	15358	16585	8	129	14	1271	92	29	231	109	45	22
Hanumangarh	14766	38301	45765	32167	26400	97	13	198	18	0	4	96	36	49	14
Jaipur	31233	26088	42203	55298	77431	1662	1471	497	2141	2864	0	0	0	0	0
Jaisalmer	22783	35163	26512	27365	52636	2521	828	1136	734	3554	63	73	69	116	32
Jalore	2232	2776	2911	2368	2133	836	606	368	376	225	56920	94635	140917	123862	26445
Jhalawar	5594	7297	7462	14896	18040	0	0	0	1	0	0	0	0	0	3
Jhunjhunu	267128	198436	241972	214701	402460	33729	20925	20029	25108	36687	12	9	6	2	3
Jodhpur	670	689	657	536	621	213	267	284	419	327	72	51	51	40	26
Karoli	367	716	837	481	288	1595	4255	1493	2126	1202	3086	9675	9626	4332	801
Kota	21081	30550	30936	32721	39361	33723	15705	13752	20512	32777	82	37	45	31	10
Nagpur	2066	1786	891	1410	1631	49254	48384	21819	40336	28313	17125	19072	9592	20627	13436
Pali	747	892	1456	3169	958	11	7	4	1	1	64076	66412	80244	90011	54894
Pratapgarh	713	2825	2321	2464	2586	9389	12110	17990	23988	15229	63268	102028	148634	131626	110536
Rajsamand	3926	4293	2443	3205	3532	211	433	325	458	354	571	652	728	692	337
S. Madhopur	42912	48819	50072	57745	62540	5	1	0	2	0	13	15	2	11	3
Sikar	18152	16493	0	27334	36584	3387	746	0	2646	2636	25105	26382	856	34566	38031
Sirohi	9855	12755	11329	20238	26082	28248	26769	26632	46330	46872	8826	9126	32179	8978	7215
Tonk	971	1373	1087	1247	900	3295	3307	3774	2270	1452	194225	209325	217573	312367	163163
Udaipur															

District	Jowar					Maize					Barley				
	2015-16	2016-17	2017-18	2018-2019	2019-2020	2015-16	2016-17	2017-18	2018-2019	2019-2020	2015-16	2016-17	2017-18	2018-2019	2019-2020
Ajmer	3440	2420	2089	1322	1657	45202	81569	74554	101153	90858	17624	28401	29316	38887	30091
Alwar	1823	1666	638	544	428	24418	20930	16248	23664	13400	5766	5583	5782	4323	4035
Banswara	341	434	505	548	577	144	195	170	183	147	133898	165712	186341	190121	126877
Baran	1183	2109	1936	1287	843	174	150	77	51	1102	24092	61512	61640	39991	8295
Barmer	5968	7366	5889	4675	8385	848	461	471	111	3924	41	8	30	18	28
Bharatpur	24	10	6	8	7	56019	34802	28622	43616	51971	11	2	4	0	1
Bhilwara	5917	8916	11031	16522	9368	12081	35496	40373	74450	64435	197736	265208	361784	382348	248191





**Priya Modi and Shilpi Gupta**

Bikaner	402451	467358	514095	531099	529065	195	25	1196	356	152	0	2	0	0	0
Bundi	1043	908	761	678	810	53	101	58	100	714	86395	87396	79263	111752	28471
Chittor	11261	14171	30990	51068	19880	14046	12452	14430	22267	16060	196016	162063	325824	326152	206977
Churu	101199	134044	144687	178801	165529	0	1	0	3	15	0	0	2	0	0
Dausa	13406	13259	14551	18152	20856	4391	3913	3408	3616	3948	578	519	781	750	566
Dholpur	87	90	69	72	92	68	173	184	357	184	3	0	0	0	0
Dungarpur	34	88	53	66	53	139	121	133	206	150	57881	87492	70309	88143	65101
Ganganagar	3011	4971	8535	15358	16585	8	129	14	1271	92	29	231	109	45	22
Hanumangarh	14766	38301	45765	32167	26400	97	13	198	18	0	4	96	36	49	14
Jaipur	31233	26088	42203	55298	77431	1662	1471	497	2141	2864	0	0	0	0	0
Jaisalmer	22783	35163	26512	27365	52636	2521	828	1136	734	3554	63	73	69	116	32
Jalore	2232	2776	2911	2368	2133	836	606	368	376	225	56920	94635	140917	123862	26445
Jhalawar	5594	7297	7462	14896	18040	0	0	0	1	0	0	0	0	0	3
Jhunjhunu	267128	198436	241972	214701	402460	33729	20925	20029	25108	36687	12	9	6	2	3
Jodhpur	670	689	657	536	621	213	267	284	419	327	72	51	51	40	26
Karoli	367	716	837	481	288	1595	4255	1493	2126	1202	3086	9675	9626	4332	801
Kota	21081	30550	30936	32721	39361	33723	15705	13752	20512	32777	82	37	45	31	10
Nagpur	2066	1786	891	1410	1631	49254	48384	21819	40336	28313	17125	19072	9592	20627	13436
Pali	747	892	1456	3169	958	11	7	4	1	1	64076	66412	80244	90011	54894
Pratapgarh	713	2825	2321	2464	2586	9389	12110	17990	23988	15229	63268	102028	148634	131626	110536
Rajsamand	3926	4293	2443	3205	3532	211	433	325	458	354	571	652	728	692	337
S. Madhopur	42912	48819	50072	57745	62540	5	1	0	2	0	13	15	2	11	3
Sikar	18152	16493	0	27334	36584	3387	746	0	2646	2636	25105	26382	856	34566	38031
Sirohi	9855	12755	11329	20238	26082	28248	26769	26632	46330	46872	8826	9126	32179	8978	7215
Tonk	971	1373	1087	1247	900	3295	3307	3774	2270	1452	194225	209325	217573	312367	163163
Udaipur															

District	Barley					Wheat				
	2015-16	2016-17	2017-18	2018-2019	2019-2020	2015-16	2016-17	2017-18	2018-2019	2019-2020
Ajmer	43542	71117	41057	42626	93375	116787	185014	128011	120782	274738
Alwar	30698	32337	30933	23316	19393	776427	941457	875183	883624	797360
Banswara	1782	3181	2952	2187	1866	170917	168950	205952	259066	291466
Baran	784	1006	409	255	434	7E+06	740053	535052	724978	883589
Barmer	45	76	80	140	95	20510	21638	21974	27939	31228
Bharatpur	6621	6860	7043	6234	4250	610124	713681	661118	675635	528584
Bhilwara	37869	79423	63042	60018	87739	274281	503063	341133	340531	597234
Bikaner	15117	8416	10661	7837	24522	282005	282654	271413	287989	355090
Bundi	2164	3429	6282	5752	9933	646200	705978	605249	658540	823931
Chittor	24932	34503	31750	28540	32358	446022	637030	626072	596726	854175
Churu	14392	15978	17789	15813	29106	74161	71736	73238	77768	92912
Dausa	17542	21209	20032	17709	18740	345636	418634	390089	371052	334490
Dholpur	1829	1823	1748	1784	1640	218346	97791	262663	271830	145496
Dungarpur	2517	2878	2922	3011	3227	79296	984034	110597	101283	1329576
Ganganagar	124436	154747	228829	193905	258590	1037261	969073	1059309	1094919	1233787
Hanumangarh	38569	402866	49633	28025	53019	973765	569358	1079529	1195063	561003
Jaipur	180062	189632	1.8E+07	184130	178229	477120	13824	512683	530407	14697
Jaisalmer	78	16	10	25	28	17427	101978	16116	14209	117562
Jalore	1281	752	711	946	801	82562	417546	100703	101948	652482
Jhalawar	605	1052	681	475	571	354563	350085	413256	426073	305253
Jhunjhunu	27830	30781	28959	23201	29278	311096	180677	340008	323290	203217
Jodhpur	694	1249	1203	1130	1436	279286	360709	150969	149730	315851
Karoli	365	686	648	457	332	468840	622806	319581	346048	725558
Kota	766	900	1359	687	1866	160235	165199	502518	666856	191093
Nagpur	22808	21365	20315	15998	33404	157499	265876	142533	145883	276483
Pali	9330	13605	13489	9659	19334	157921	241538	216513	146542	356002
Pratapgarh	3226	4652	5265	3150	5892	71148	105559	220254	286092	113318
Rajsamand	15546	19767	20356	14655	20283	230484	350067	112397	66677	323344
S. Madhopur	1482	1774	1479	1763	1781	323185	333627	251725	300227	295582
Sikar	101505	102817	83150	88078	86150	91608	108650	66374	87890	107151







**Priya Modi and Shilpi Gupta**

District	Wheat					Rape & Mustard				
	2015-16	2016-17	2017-18	2018-2019	2019-2020	2015-16	2016-17	2017-18	2018-2019	2019-2020
Sirohi	2936	3376	1981	2604	3580	160972	250843	152773	143883	229766
Tonk	9768	15262	10565	7382	16132	160972	250843	152773	143883	229766
Udaipur	25258	24740	22399	20469	25152	210840	250975	229859	217764	262499
Ajmer	43542	71117	41057	42626	93375	116787	185014	128011	120782	274738
Alwar	30698	32337	30933	23316	19393	776427	941457	875183	883624	797360
Banswara	1782	3181	2952	2187	1866	170917	168950	205952	259066	291466
Baran	784	1006	409	255	434	7E+06	740053	535052	724978	883589
Barmar	45	76	80	140	95	20510	21638	21974	27939	31228
Bharatpur	6621	6860	7043	6234	4250	610124	713681	661118	675635	528584
Bhilwara	37869	79423	63042	60018	87739	274281	503063	341133	340531	597234
Bikaner	15117	8416	10661	7837	24522	282005	282654	271413	287989	355090
Bundi	2164	3429	6282	5752	9933	646200	705978	605249	658540	823931
Chittor	24932	34503	31750	28540	32358	446022	637030	626072	596726	854175
Churu	14392	15978	17789	15813	29106	74161	71736	73238	77768	92912
Dausa	17542	21209	20032	17709	18740	345636	418634	390089	371052	334490
Dholpur	1829	1823	1748	1784	1640	218346	97791	262663	271830	145496
Dungarpur	2517	2878	2922	3011	3227	79296	984034	110597	101283	1329576
Ganganagar	124436	154747	228829	193905	258590	1037261	969073	1059309	1094919	1233787
Hanumangarh	38569	402866	49633	28025	53019	973765	569358	1079529	1195063	561003
Jaipur	180062	189632	1.8E+07	184130	178229	477120	13824	512683	530407	14697
Jaisalmer	78	16	10	25	28	17427	101978	16116	14209	117562
Jalore	1281	752	711	946	801	82562	417546	100703	101948	652482
Jhalawar	605	1052	681	475	571	354563	350085	413256	426073	305253
Jhunjhunu	27830	30781	28959	23201	29278	311096	180677	340008	323290	203217
Jodhpur	694	1249	1203	1130	1436	279286	360709	150969	149730	315851
Karoli	365	686	648	457	332	468840	622806	319581	346048	725558
Kota	766	900	1359	687	1866	160235	165199	502518	666856	191093
Nagpur	22808	21365	20315	15998	33404	157499	265876	142533	145883	276483
Pali	9330	13605	13489	9659	19334	157921	241538	216513	146542	356002
Pratapgarh	3226	4652	5265	3150	5892	71148	105559	220254	286092	113318
Rajsamand	15546	19767	20356	14655	20283	230484	350067	112397	66677	323344
S. Madhopur	1482	1774	1479	1763	1781	323185	333627	251725	300227	295582
Sikar	101505	102817	83150	88078	86150	91608	108650	66374	87890	107151
Sirohi	2936	3376	1981	2604	3580	160972	250843	152773	143883	229766
Tonk	9768	15262	10565	7382	16132	160972	250843	152773	143883	229766
Udaipur	25258	24740	22399	20469	25152	210840	250975	229859	217764	262499

District	Rape & Mustard					Paddy				
	2015-16	2016-17	2017-18	2018-2019	2019-2020	2015-16	2016-17	2017-18	2018-2019	2019-2020
Ajmer	47433	66655	40652	50785	67947	4	16	21	14	7
Alwar	340282	446945	466873	534464	492851	578	609	561	140	195
Banswara	62	47	65	12	8	13767	30531	28868	22518	21185
Baran	150010	134158	136179	236101	125471	39515	51546	45457	48651	45936
Barmar	9278	11523	9729	12996	18887	0	0	0	0	0
Bharatpur	309039	390284	384758	485598	403710	5161	2939	2107	2794	2234
Bhilwara	33316	49237	27128	40322	58594	1144	1179	1363	1200	1031
Bikaner	69693	77043	128813	202522	196930	30	18	0	0	0
Bundi	71202	54712	28407	96594	67238	88816	118522	133100	125013	155524
Chittor	58789	64892	53119	64373	26409	1972	1173	2476	1986	874
Churu	43106	55332	75815	119105	88505	0	0	0	0	0
Dausa	81905	85435	102924	93975	88392	0	0	0	0	0





**Priya Modi and Shilpi Gupta**

Dholpur	84984	130278	136652	152436	138219	815	1119	904	1494	1165
Dungarpur	560	666	689	544	212	11022	22429	19733	13894	17853
Ganganagar	365583	347483	344348	463200	380720	40372	39130	29074	31654	30396
Hanumangarh	196220	172788	174808	230298	177639	92693	101135	98212	105225	86395
Jaipur	92975	136781	110475	121993	155038	0	0	0	0	0
Jaisalmer	47883	37799	40799	50691	41728	0	0	0	0	0
Jalore	88711	90409	105458	101804	103390	0	0	0	0	0
Jhalawar	50455	53137	10232	113814	56339	6586	8046	12823	10681	7576
Jhunjhunu	104897	98401	102447	114813	115090	0	0	0	0	0
Jodhpur	130677	168378	196458	232367	252080	0	0	0	0	0
Karoli	116013	146511	132126	165832	165967	2434	2887	1942	2909	2709
Kota	84619	68816	61516	118583	43842	54157	60340	63161	74124	94703
Nagpur	70739	54578	53592	88293	83776	0	0	0	0	0
Pali	47950	93007	53140	39649	77975	0	0	0	0	0
Pratapgarh	12816	15218	16097	28507	16025	1727	1884	1961	1842	1697
Rajsamand	1111	1550	1046	1050	1278	42	66	73	57	57
S. Madhopur	157184	270576	170886	300838	280592	4258	3618	3154	4342	6296
Sikar	14918	19929	12275	11967	13831	4258	3618	3154	4	0
Sirohi	310197	409669	296762	444994	485077	10	5	0	0	0
Tonk	310197	409669	296762	444994	485077	10	2	5	4	0
Udaipur	8740	9820	7190	5531	4039	4667	5488	5937	4629	4721
District	Paddy									
	2015-16	2016-17	2017-18	2018-2019	2019-2020	2015-16	2016-17	2017-18	2018-2019	2019-2020
Ajmer	47433	66655	40652	50785	67947	4	16	21	14	7
Alwar	340282	446945	466873	534464	492851	578	609	561	140	195
Banswara	62	47	65	12	8	13767	30531	28868	22518	21185
Baran	150010	134158	136179	236101	125471	39515	51546	45457	48651	45936
Barmer	9278	11523	9729	12996	18887	0	0	0	0	0
Bharatpur	309039	390284	384758	485598	403710	5161	2939	2107	2794	2234
Bhilwara	33316	49237	27128	40322	58594	1144	1179	1363	1200	1031
Bikaner	69693	77043	128813	202522	196930	30	18	0	0	0
Bundi	71202	54712	28407	96594	67238	88816	118522	133100	125013	155524
Chittor	58789	64892	53119	64373	26409	1972	1173	2476	1986	874
Churu	43106	53332	75815	119105	88505	0	0	0	0	0
Dausa	81905	85435	102924	93975	88392	0	0	0	0	0
Dholpur	84984	130278	136652	152436	138219	815	1119	904	1494	1165
Dungarpur	560	666	689	544	212	11022	22429	19733	13894	17853
Ganganagar	365583	347483	344348	463200	380720	40372	39130	29074	31654	30396
Hanumangarh	196220	172788	174808	230298	177639	92693	101135	98212	105225	86395
Jaipur	92975	136781	110475	121993	155038	0	0	0	0	0
Jaisalmer	47883	37799	40799	50691	41728	0	0	0	0	0
Jalore	88711	90409	105458	101804	103390	0	0	0	0	0
Jhalawar	50455	53137	10232	113814	56339	6586	8046	12823	10681	7576
Jhunjhunu	104897	98401	102447	114813	115090	0	0	0	0	0
Jodhpur	130677	168378	196458	232367	252080	0	0	0	0	0
Karoli	116013	146511	132126	165832	165967	2434	2887	1942	2909	2709
Kota	84619	68816	61516	118583	43842	54157	60340	63161	74124	94703
Nagpur	70739	54578	53592	88293	83776	0	0	0	0	0
Pali	47950	93007	53140	39649	77975	0	0	0	0	0
Pratapgarh	12816	15218	16097	28507	16025	1727	1884	1961	1842	1697
Rajsamand	1111	1550	1046	1050	1278	42	66	73	57	57
S. Madhopur	157184	270576	170886	300838	280592	4258	3618	3154	4342	6296
Sikar	14918	19929	12275	11967	13831	4258	3618	3154	4	0
Sirohi	310197	409669	296762	444994	485077	10	5	0	0	0
Tonk	310197	409669	296762	444994	485077	10	2	5	4	0
Udaipur	8740	9820	7190	5531	4039	4667	5488	5937	4629	4721





Priya Modi and Shilpi Gupta

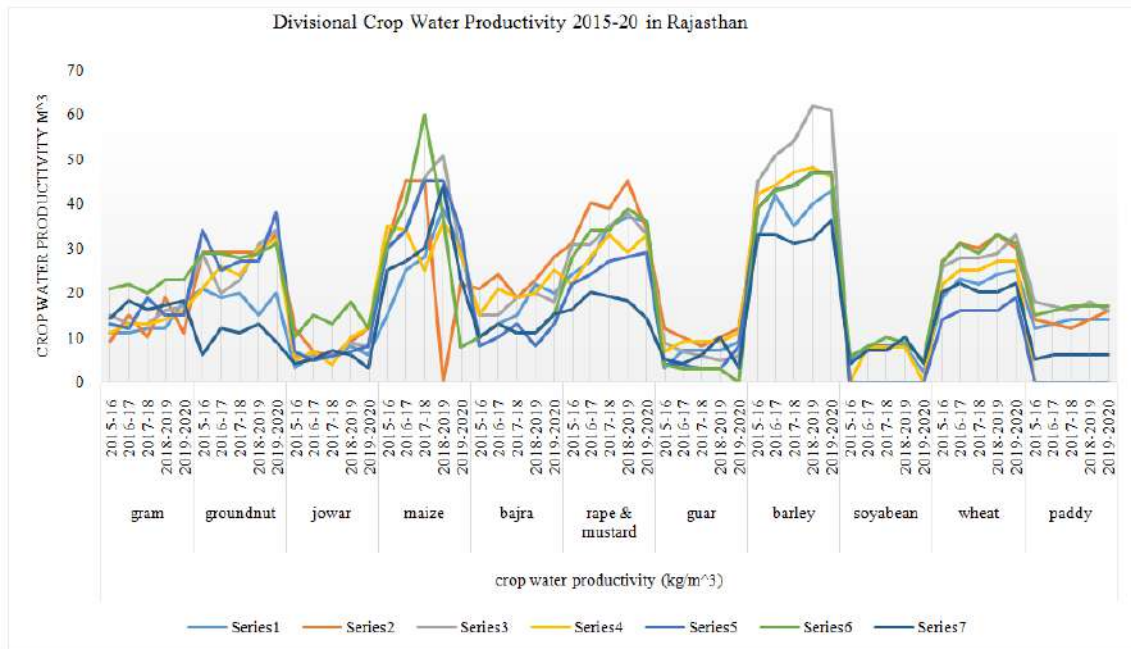


Figure 1: Crop water productivity in virtual water context





## Analysis of Reinforced Concrete Structures Beams-Columns Joints using Finite Element Modellings

J.Selwyn Babu<sup>1</sup>, Santhosh Varma<sup>2\*</sup> and J.Rex<sup>1</sup>

<sup>1</sup>Assistant Professor, Department of Civil Engineering, Malla Reedy Engineering College, Hyderabad, Telangana, India.

<sup>2</sup>PG Scholar, Department of Civil Engineering, Malla Reedy Engineering College, Hyderabad, Telangana, India.

Received: 24 Nov 2021

Revised: 23 Dec 2021

Accepted: 13 Jan 2022

### \*Address for Correspondence

#### Santhosh Varma

PG Scholar, Department of Civil Engineering,

Malla Reedy Engineering College,

Hyderabad, Telangana, India.

Email: santhoshvarma369@gmail.com.



This is an Open Access Journal / article distributed under the terms of the **Creative Commons Attribution License** (CC BY-NC-ND 3.0) which permits unrestricted use, distribution, and reproduction in any medium, provided the original work is properly cited. All rights reserved.

### ABSTRACT

Various structures in many nations, including Portugal, were not completely installed for earthquake protection in recent past. As a result, buildings constructed in the 1960s using RC Beam-Column Joints used less reinforcing steel than those constructed in line with more current standards. As a result, determining the soundness of ancient RC Beam-Column joints is critical in determining the future requirement for retrofitting and the intervention's goals. As a result, a building is deemed typical of the stock constructed in the 1960s in Lisbon, Portugal, in order to place a value on contemporary modelling methods for the assessment of existing jerry-made RC Beam-Column joints. SAP 2000 is utilised to determine the important joints of the structure. Pushover analysis is done since it is an ancient structure that needs restoration. Push the structure till it reaches its maximum capacity to disfigure, as the name suggests. It aids in comprehending the disfigurement and breaking of a structure in the case of an earthquake, as well as providing reasonable knowledge of building deformation and the creation of plastic hinges in the structure. The structure is then modelled in STAAD. Pro in accordance with IS requirements. The structure was simulated in order to determine the forces on the circular beam column joints based on the SAP 2000 analysis. Finally, crucial beam-column junctions are rectified using a retrofit technique such as FRP wrapping in Abaqus, and graphs are displayed to show that if the retrofitting had been done sooner, the beam-column joint failure might have been avoided.

**Keywords:** RC Beam-Column joint, Staad pro, Sap2000, Abaqus, FRP wrapping, FEM.





## INTRODUCTION

Earthquakes have the potential to cause the collapse of reinforced concrete structures, as well as the loss of lives and valuable property. The vast majority of structures constructed throughout the world in accordance with non-seismic standards of practise are incapable of withstanding even small earthquake stress. It is essential that the reinforced concrete structure has sufficient lateral resistance strength to prevent brittle fracture in seismic conditions. Because dismantling and rebuilding such RC buildings is so expensive, it may be more cost-effective to upgrade the main structural components in order to ensure the building's and people's safety in the first place. There may be non-ductile reinforcing components at the beam-column joint region, with inadequate or no shear reinforcement, as well as short anchor lengths of bottom steel bars that run down the longitudinal beam in these early RC structures. Furthermore, because of the strong beam design, the joint may be capable of withstanding considerable resistance. When a bond slide or joint shear failure occurs, the overall strength of the structure is significantly decreased.

### Details of Building

The proposed site is an eight-story structure (ground floor +seven storeys), with measurements of 36.80m in X-directions and 10.85m in Y-direction. The structure stands at a height of 27m. The structure was planned and constructed in the 2020s

### Objective of the projects

Through the use of a pushover analysis on both the beam and the column, the researchers hope to discover the critical beam-column junction in this investigation. A critical beam-column junction is investigated using the finite element method in this research, which involves the application of total deformation and stress to the junction. It is therefore necessary to adjust the joints in order to compare the behaviour of different joints in terms of total deformation and stress distribution. The pushover research was carried out with the assistance of the SAP2000 software. ABAQUS version 6.13 is utilised to do the Finite Element Analysis, in addition to the other software.

### Forces acting on a Beam Column Joint

The pattern of forces acting on a joint is dictated by the configuration of the joint as well as the kinds of loads pushing on the joint. Loads acting on the three types of joints are investigated in terms of stresses and the fracture patterns that occur as a consequence of these stress and fracture patterns. The forces acting on an internal joint as a result of gravity loading are shown in Figure 2. a. formalised Loads from the beam ends, as well as axial stresses from the columns, may be transmitted directly via the joint. When lateral (or seismic) loading occurs, the equilibrating forces from beams and columns cause diagonal tensile and compressive stresses to develop inside the joint, as shown in Fig. 2. (b). Fractures occur perpendicular to the stress diagonal A-B of the joint and at the joint's faces, where the beams act as a frame for the joint. Unlike tension ties, compression struts are shown with dashed lines, while tension ties are depicted with solid lines. The use of transverse reinforcements to bridge the plane of failure and resist diagonal tensile forces is necessary due to the weakness of concrete under tension.

### FRP Composites

Since the mid-1980s, fibre-reinforced polymer reinforcing systems have been used to strengthen weak concrete structural components and to restore damaged or deteriorated concrete structures, mostly in the construction industry. Composites were first utilised in RC bridges as flexural strengthening materials and as confining reinforcement in RC columns, and they have since become more popular. Since the inception of the research, the range of possible applications has expanded to include beams, slabs, columns, shear walls, chimneys, vaults, domes, and trusses, among other things.



**Selwyn Babu et al.,**

The term composite material (also known as composite) refers to a well-balanced combination of two or more elements that results in a product that is more efficient than the sum of its parts. Composite materials are used in a variety of applications. One of the components is the reinforcing or fibre phase (which provides strength), while the other is the matrix phase (in which the fibres are embedded). Through its shear transfer capability, the matrix acts as a binder, keeping the fibres in place and contributing to the structural integrity of the composite material in general. The matrix also has the additional function of protecting the fibre from the external environment in which the composite is placed. Continuous fibres are used in FRP products for structural engineering since they are endlessly long and therefore are referred to as continuous fibres. Fibre-reinforced polymers get their name from the fact that these fibres are used in relatively large quantities (ranging from 20 to 60% of the total volume of the polymer resin) to reinforce the polymer resin (FRP). When two distinct materials are mixed, the outcome is a component that has enhanced strength, stiffness, and toughness over and beyond the properties of the individual materials used in the construction. Fibrous fibres such as glass, carbon, aramid, and boron are the most common types of fibres used to create strong sheets and fabrics, and they are also the most expensive.

### BEAM-COLUMN JOINT

A beam-column junction is the place where beams and columns of a reinforced concrete construction are connected. Due to the passage of a high number of forces between them (i.e. beams and columns), they are important areas in a reinforced concrete moment resistant frame. The standard design practice does not include a design assessment for beam-column joints. However, the collapse of similar frameworks during previous earthquakes throughout the globe has shown the significance of joint stresses. Shear at the joints leads to the structure collapsing. Only in the last several decades has detailed research into the joints for such structures been conducted. The fundamental criterion for a junction in a reinforced concrete structure to function well is:

- A joint's service load performance should be comparable to that of the member it joins.
- The strength of a joint should be equal to or higher than the strength of the most unfavourable load combination that the adjacent component can bear, repeated as many times as necessary to ensure that the joint is strong.
- The structure's strength should not be determined by the joint's strength, and its behaviour should not impede the growth of the neighbouring member's full-strength capability.

### Types of Joints in a Frame

- Interior Beam-Column Junction — An interior joint is one that connects four beams to a single column.
- Exterior Beam-Column Connection – An exterior joint is formed when three perpendicular beams are joined to the vertical face of a single column.
- Corner Beam-Column Joint – Corner joints are the joints that can be seen on the frame's corner edges and are formed by the joining of two beams and two columns. When two beams meet at a corner junction, the vertical face of a single column becomes the connecting point.

### FINITE ELEMENT ANALYSIS

Certain engineering problems cannot be solved analytically owing to the unpredictability of material properties, limit conditions, and the structure itself. This is especially true for structural issues. In engineering, the Finite Element Method, also known as Finite Element Analysis, is a method for finding approximate solutions to a wide range of boundary value or field value problems that may be solved numerically. In its most basic form, FEM divides or displays the structure into small finite components, which are then combined to form the final structure. There are a number of subdomains in the issue domain as a result of this division. Overall, this is a hypothesised technique, and the final findings must be widely known before it can be implemented successfully. Whenever it comes to the analysis of systems, finite element modelling (FEM) is a reliable technique for estimating the displacements, stresses, and traces in a structure under a collection of masses. Using the Finite Element Method, elliptic fractional differential situations are transformed into hard and fast arithmetical standards that are difficult to answer. Initial value problems involving an illustrated or hyperbolic differential condition, as well as the underlying circumstances, cannot be fully resolved using the finite detail method (other than the restriction conditions). When dealing with





Selwyn Babu et al.,

parabolic or hyperbolic differential equations, time is one of the independent variables. The Finite Element Method and the Finite Difference Method are needed in order to provide a solution to a preliminary fee issue.

## METHODOLOGY

- Finding critical beam-column joints. SAP2000
- Modelling of joint and carrying out the required rectification process. ABAQUS
- Determining the forces in the critical beam column joints. STAAD PRO

### SAP-2000

In the initial phase, the structure was modelled and built in SAP 2000, with Pushover Analysis used to identify key beam-column intersections. SAP2000 is a powerful structural design programme that may be used to investigate and plan an auxiliary structure. It is possible to exhibit fundamental and advanced frameworks in a natural protest-based displaying condition that simplifies and reorganises the engineering process. The frameworks can range from 2D to 3D and from simple to intricate geometry, and they can be dissected, composed, and advanced using this method. The major joints of the construction are identified with the help of SAP 2000. Because it is an ancient structure in need of renovation, a pushover analysis is performed.

### STAAD. Pro

STAAD. Using the Pro software package, you may conduct traditional first order static analysis, 2nd order p-delta analysis, geometric nonlinear analysis, Pushover analysis (Static-Nonlinear Analysis), and buckling analysis, to name a few applications. It may be utilised in combination with a variety of dynamic analysis methods, such as modal extraction, time history analysis, and response spectrum analysis, among others. The dimensions of members used in the structure are as follows:

#### Columns sizes

700 mm X 300 mm  
500 mm X 250 mm  
400 mm X 250 mm  
300 mm X 250 mm

#### Beams sizes

650 mm X 250 mm  
650 mm X 300 mm

M30 concrete was utilized in the construction of the structure. Fe415 steel was utilized in the construction. The results are acquired in STAAD. Pro, and the crucial beam column joints are modeled in ABAQUS with the forces taken into account, and the results are observed.

### ABAQUS

Under transient loads, a finite-element analyser uses an explicit integration technique to solve extremely nonlinear systems with many complicated connections. The fundamental task of ABAQUS is to design and assess the building structure's essential beam-column joints. The SAP 2000 results are utilised to replicate the real joint deflections and forces. ABAQUS is primarily used for beam-column joint analysis due to its Finite Element modelling, which produces more accurate results than other software and also has the ability to provide more detail about the model developed.





Selwyn Babu et al.,

## RESULTS

### SAP2000 RESULTS

The modelling of the structure is completed, and the section attributes of the sections are established. Following the application of various load instances and various load combinations, the result is produced in the three axes ("x," "y," and "z," respectively), which are the crucial joints.

The figure below shows the result received after applying the Dead Load on the system.

### STAAD PRO RESULTS

According to the SAP2000, there are 9 important nodes along various push axes.

### ABAQUS RESULTS

The fundamental task of ABAQUS is to design and assess the building structures essential beam-column joints. The SAP2000 and STAAD PRO results. It was used to model actual joint deflection and forces. Using the table above, we can compare stress and displacement values with and without FRP Wrapping, and we can also compare with and without FRP Wrapping. Below are graphs that show the stress and displacement reductions that happened as a consequence of the rectification process. Node of Critical Importance-A node of critical importance is a node that has a lot of (B,2,4). The beam column joint is wrapped in FRP and rectangle meshing is performed, enhancing the beam column joint's strength and load bearing capacity and thereby correcting it.

As can be observed in the two tables above, the stress and displacement values obtained with and without FRP Wrapping are similar in both directions. The table that show how the rectification process reduces the amount of stress and displacements that occur as a consequence of the operation clearly illustrate how the rectification process reduces the amount of stress and displacements that occur as a consequence of the operation.

Critical Node-(C,2,8)

Fig 10 After analysis, the Critical Node (C,2,8) The same section is cut for further steps; the section is zoomed in view of the points chosen. The same section is cut out after the FRP Wrapping is applied; the section is zoomed in on the cut-out section; FRP Wrapped Beam Column Joint after FRP Wrapping; FRP Wrapped Beam Column Joint after FRP Wrapping; FRP Wrapped Beam Column Joint after FRP Wrapping; FRP Wrapped Beam Column Joint after FRP Wrapping; FRP Wrapped Beam Column Joint after FRP Wrapping; FRP Wrapped Beam Column Joint after FRP Wrapping. The stress and displacement values are shown in the table above with and without FRP Wrapping, as well as with and without FRP Wrapping. In the following graphs, the stress and displacement reductions that occurred as a result of the rectification procedure are shown in more detail.

## CONCLUSION

- If the beam-column joint had been modified and repaired in a timely manner, the failure of the beam-column joint could have been avoided. The loads on the structure were more than the members' bearing capacity, resulting in the condition known as "weak column, strong beam."
- The use of Carbon Fiber Reinforced Polymer, or CFRP, in the construction of the members reduced stresses on them by about 10% on average, which is a considerable improvement over the members' prior state of construction.
- The displacement values of non-retrofitted members were reduced by roughly 10-15% when compared to CFRP-wrapped members.
- Carbon Fiber Reinforced Polymer, or CFRP, is also a cost-effective option since the mass required per beam-column joint is quite low, and the stress and displacement values are reduced very well when compared to retrofitting procedures.







**Selwyn Babu et al.,**

- When the building was modified with CFRP, it would have avoided a "Soft Storey" collapse that occurred on the ground and first levels. This will result in a low-cost facility that will be available for usage in the future.

**REFERENCES**

1. "Experimental Investigation on Seismic Behavior of Eccentric Reinforced Concrete Beam-Column-SlabConnections", *ACI Structural Journal*, vol. 105, no. 2, 2008.
2. A.Ghobarah and A.Said, "Shear strengthening of beam-column joints", *Engineering Structures*, vol. 24, no. 7, pp. 881-888, 2002.
3. P.Panjwani and D. DUBEY, "Study of Reinforced Concrete Beam-Column Joint", *International Journal of Engineering Research*, vol. 4, no. 6, pp.321-324, 2015.
4. S.V.Chaudhari, K. K.A.Mukane and M. M.A.Chakrabarti, "Comparative Study on Exterior RCC Beam Column Joint Subjected to Monotonic Loading", *International Journal of Computer Applications*, vol. 102, no. 3, pp. 35-40, 2014.
5. A.GHOBARAH\* and A.SAID†, "SEISMIC REHABILITATION OF BEAM-COLUMN JOINTS USING FRP LAMINATES", *Journal of Earthquake Engineering*, vol. 5, no. 1, pp. 113-129, 2001.
6. A.Kwan, "Improved Wide-Column-Frame Analogy for Shear/Core Wall Analysis", *Journal of Structural Engineering*, vol. 119, no. 2, pp. 420-437, 1993.
7. Z.Su, T.Han and S.Sun, "Nonlinear Static Pushover Analysis for Shear Wall Structures in SAP2000 Program", *Applied Mechanics and Materials*, vol. 470, pp.1007-1010, 2013.
8. J. Saravanan and G. Kumaran, "Joint shear strength of FRP reinforced concrete beam-column joints", *Open Engineering*, vol. 1, no. 1, 2011.
9. Hemidine, "Numerical investigation on exterior reinforced concrete Beam-Column joints strengthened by composite fiber reinforced polymer (CFRP)", *International Journal of the Physical Sciences*, vol. 6, no. 28, 2011.
10. "Retrofitting of Reinforced Beam-Column Joints Using Hybrid Laminates", *International Journal of Science and Research (IJSR)*, vol. 5, no.4, pp.2301-2304, 2016.

**Table 1: STAAD. Pro employs the following load combinations, which are listed in the following table:**

Load combination No.	Multiplying factor of Loads				
	DL	LL	WL(+Z)	WL(-Z)	TH
1	1.5	1.5	0	0	0
2	1.2	1.2	1.2	0	0
3	1.2	1.2	0	1.2	0
4	1.2	1.2	-1.2	0	0
5	1.2	1.2	0	-1.2	0
6	1.2	1.2	0	0	1.2
7	1.2	1.2	0	0	-1.2
8	1.5	0	1.5	0	0
9	1.5	0	0	1.5	0
10	1.5	0	-1.5	0	0
11	1.5	0	0	-1.5	0
12	1.5	0	0	0	1.5
13	1.5	0	0	0	-1.5
14	0.9	0	0	0	1.5
15	0.9	0	0	0	-1.5

DL: Dead Load, LL: Live Load, WL: Wind Load





**Selwyn Babu et al.,**

**Table: 2 Critical Node Points and Reinforcement Details**

Node No.	Location	Connected Members	Reinforcement
1	A,2,2	B-63	Top:3# 16Ø; Bottom: 3# 16Ø; Stirrups; 2legged 6Ø;@300mm c/c
		B-79	Top:3# 16Ø; Bottom: 3# 16Ø; Stirrups; 2legged 6Ø;@300mm c/c
		B-80	Top:3# 16Ø; Bottom: 3# 16Ø; Stirrups; 2legged 6Ø;@300mm c/c
		B-101	Top:3# 16Ø; Bottom: 3# 16Ø; Stirrups; 2legged 6Ø;@300mm c/c
		C-92	Main:6# 25Ø; Ties:6Ø @250mm c/c
		C-145	Main:6# 25Ø; Ties:6Ø @250mm c/c
2	A,2,3	B-116	Top:3# 16Ø; Bottom: 3# 16Ø; Stirrups; 2legged 6Ø;@300mm c/c
		B-132	Top:3# 16Ø; Bottom: 3# 16Ø; Stirrups; 2legged 6Ø;@300mm c/c
		B-133	Top:3# 16Ø; Bottom: 3# 16Ø; Stirrups; 2legged 6Ø;@300mm c/c
		B154	Top:3# 16Ø; Bottom: 3# 16Ø; Stirrups; 2legged 6Ø;@300mm c/c
		C-145	Main:6# 25Ø; Ties:6Ø @250mm c/c
		C-198	Main:6# 25Ø; Ties:6Ø @250mm c/c
3	B,2,2	B-59	Top:3# 16Ø; Bottom: 3# 16Ø; Stirrups; 2legged 6Ø;@300mm c/c
		B-73	Top:3# 16Ø; Bottom: 3# 16Ø; Stirrups; 2legged 6Ø;@300mm c/c
		B-99	Top:3# 16Ø; Bottom: 3# 16Ø; Stirrups; 2legged 6Ø;@300mm c/c
		C-88	Main:6# 25Ø; Ties:6Ø @250mm c/c
		C-141	Main:6# 25Ø; Ties:6Ø @250mm c/c
4	C,2,2	B-60	Top:3# 16Ø; Bottom: 3# 16Ø; Stirrups; 2legged 6Ø;@300mm c/c
		B-74	Top:3# 16Ø; Bottom: 3# 16Ø; Stirrups; 2legged 6Ø;@300mm c/c
		B-75	Top:3# 16Ø; Bottom: 3# 16Ø; Stirrups; 2legged 6Ø;@300mm c/c
		B-100	Top:3# 16Ø; Bottom: 3# 16Ø; Stirrups; 2legged 6Ø;@300mm c/c
		C-89	Main:6# 25Ø; Ties:6Ø @250mm c/c
		C-142	Main:6# 25Ø; Ties:6Ø @250mm c/c
5	B,2,3	B-112	Top:3# 16Ø; Bottom: 3# 16Ø; Stirrups; 2legged 6Ø;@300mm c/c
		B-126	Top:3# 16Ø; Bottom: 3# 16Ø; Stirrups; 2legged 6Ø;@300mm c/c
		B-152	Top:3# 16Ø; Bottom: 3# 16Ø; Stirrups; 2legged 6Ø;@300mm c/c
		C-141	Main:6# 25Ø; Ties:6Ø @250mm c/c
		C-124	Main:6# 25Ø; Ties:6Ø @250mm c/c
6	C,2,3	B-113	Top:3# 16Ø; Bottom: 3# 16Ø; Stirrups; 2legged 6Ø;@300mm c/c
		B-127	Top:3# 16Ø; Bottom: 3# 16Ø; Stirrups; 2legged 6Ø;@300mm c/c
		B-128	Top:3# 16Ø; Bottom: 3# 16Ø; Stirrups; 2legged 6Ø;@300mm c/c
		B-153	Top:3# 16Ø; Bottom: 3# 16Ø; Stirrups; 2legged 6Ø;@300mm c/c
		C-142	Main:6# 25Ø; Ties:6Ø @250mm c/c
		C-195	Main:6# 25Ø; Ties:6Ø @250mm c/c
7	B,2,4	B-165	Top:3# 16Ø; Bottom: 3# 16Ø; Stirrups; 2legged 6Ø;@300mm c/c
		B-179	Top:3# 16Ø; Bottom: 3# 16Ø; Stirrups; 2legged 6Ø;@300mm c/c





Selwyn Babu et al.,

		B-205	Top:3# 16Ø; Bottom: 3# 16Ø; Stirrups; 2legged 6Ø;@300mm c/c
		C-194	Main:6# 25Ø; Ties:6Ø @250mm c/c
		C-247	Main:6# 25Ø; Ties:6Ø @250mm c/c
8	A,2,8	B-375	Top:3# 16Ø; Bottom: 3# 16Ø; Stirrups; 2legged 6Ø;@300mm c/c
		B-376	Top:3# 16Ø; Bottom: 3# 16Ø; Stirrups; 2legged 6Ø;@300mm c/c
		B-389	Top:3# 16Ø; Bottom: 3# 16Ø; Stirrups; 2legged 6Ø;@300mm c/c
		C-390	Main:6# 25Ø; Ties:6Ø @250mm c/c
		C-405	Main:6# 25Ø; Ties:6Ø @250mm c/c
9	C,2,8	B-378	Top:3# 16Ø; Bottom: 3# 16Ø; Stirrups; 2legged 6Ø;@300mm c/c
		B-392	Top:3# 16Ø; Bottom: 3# 16Ø; Stirrups; 2legged 6Ø;@300mm c/c
		B-393	Top:3# 16Ø; Bottom: 3# 16Ø; Stirrups; 2legged 6Ø;@300mm c/c
		B-418	Top:3# 16Ø; Bottom: 3# 16Ø; Stirrups; 2legged 6Ø;@300mm c/c
		C-407	Main:6# 25Ø; Ties:6Ø @250mm c/c
		C-412	Main:6# 25Ø; Ties:6Ø @250mm c/c

Table 3:Results of FRP wrapping details with Abaqus

S.no	STANDARD		FRP	
	STRESS (N)	DISPLACEMENT (mm)	STRESS-FRP (N)	DISPLACEMENT- FRP(mm)
1	371.882	6.174	371.975	6.046
2	372.459	6.162	370.503	6.058
3	379.508	6.097	361.714	6.017
4	371.466	6.068	370.907	6.013
5	369.326	6.042	368.732	6.009
6	368.732	6.026	366.587	6.017
7	364.153	6.026	363.199	6.011
8	364.345	6.038	363.038	5.999
9	366.828	6.054	364.768	5.991
10	369.211	6.070	368.897	5.983
11	371.377	6.099	371.021	5.986
12	378.330	6.127	366.350	5.991
13	379.892	6.194	361.215	6.032
14	372.152	6.027	361.215	6.021

FRP: Fibre-Reinforced Polymer

Table 4: Results of Cut section of FRP wrapping details with Abaqus

S.no	STANDARD		FRP	
	STRESS (N)	DISPLACEMENT (mm)	STRESS-FRP (N)	DISPLACEMENT-FRP(mm)
1	782.997	-2.974	781.720	-2.895
2	794.351	-2.967	770.675	-2.898
3	800.803	-2.955	765.462	-2.896
4	792.800	-2.946	799.332	-2.898
5	798.074	-2.939	769.233	-2.901
6	780.088	-2.933	779.979	-2.904
7	777.459	-2.927	777.263	-2.909





**Selwyn Babu et al.,**

8	777.233	-2.922	777.473	-2.914
9	780.102	-2.917	779.945	-2.919
10	788.641	-2.925	774.774	-2.913
11	797.177	-2.933	769.874	-2.910
12	791.177	-2.941	780.414	-2.908
13	799.161	-2.953	767.175	-2.910
14	783.124	-2.960	781.562	-2.907

FRP: Fibre-Reinforced Polymer

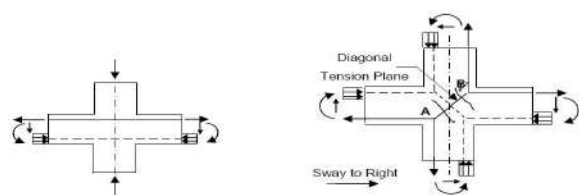
**Table 5: Results of final Analysis of FRP wrapping details with Abaqus**

S.No	STANDARD		FRP	
	STRESS (N)	DISPLACEMENT (mm)	STRESS-FRP(N)	DISPLACEMENT-FRP(mm)
1	899.087	1.296	899.794	1.276
2	899.087	1.297	898.013	1.278
3	913.016	1.300	897.863	1.279
4	915.673	1.302	901.161	1.282
5	920.905	1.304	905.012	1.284
6	922.049	1.306	907.838	1.286
7	922.173	1.308	909.072	1.288
8	921.822	1.311	909.164	1.290
9	919.197	1.313	908.118	1.293
10	916.590	1.316	905.490	1.295
11	913.917	1.319	901.818	1.298
12	907.798	1.321	898.443	1.301
13	899.328	1.324	898.193	1.304
14	897.559	1.328	899.730	1.306

FRP: Fibre-Reinforced Polymer



**Fig 1:Existing Building**



**Fig 2:Interiorjoint of RC Beam-Column**





Selwyn Babu et al.,

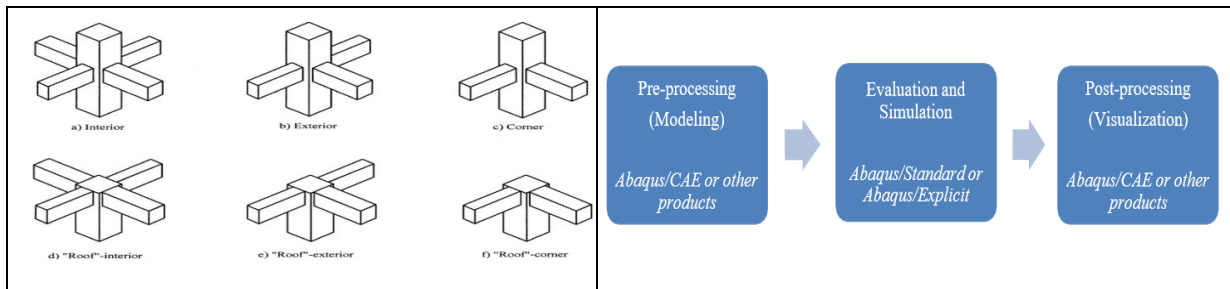


Fig 3: Beam - column joints in frames come in a variety of shapes and sizes.

Fig 4: ABAQUS software order of use

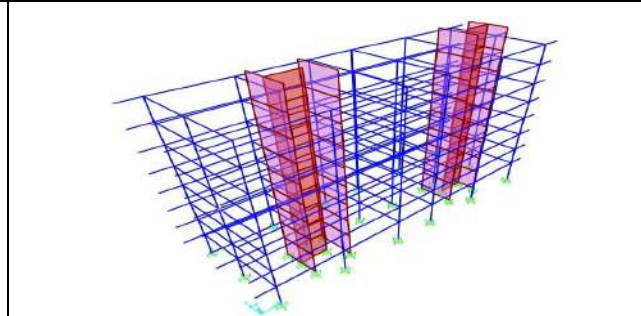
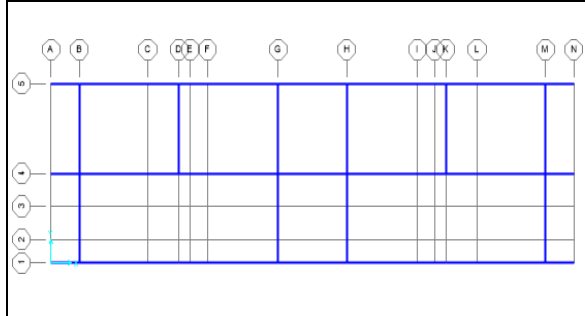


Fig 5: 3D view of the structure

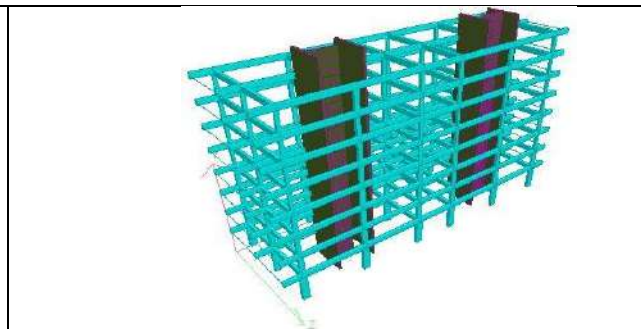
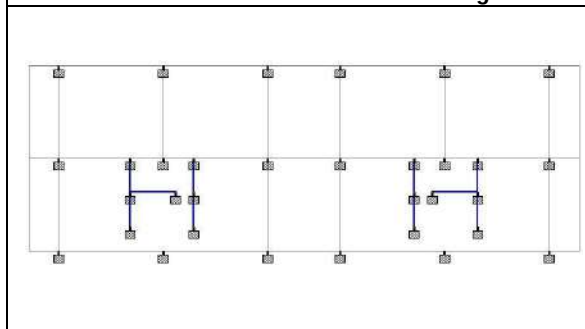


Fig 6 : STAAD. Pro Shear walls and other structural components may be seen in a 3D generated picture of the structure.

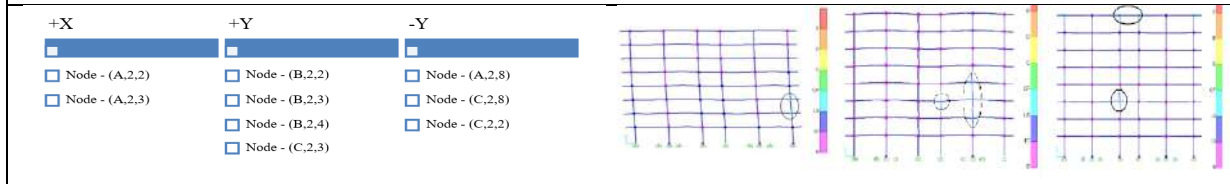


Fig 7:Critical Nodes





Selwyn Babu et al.,

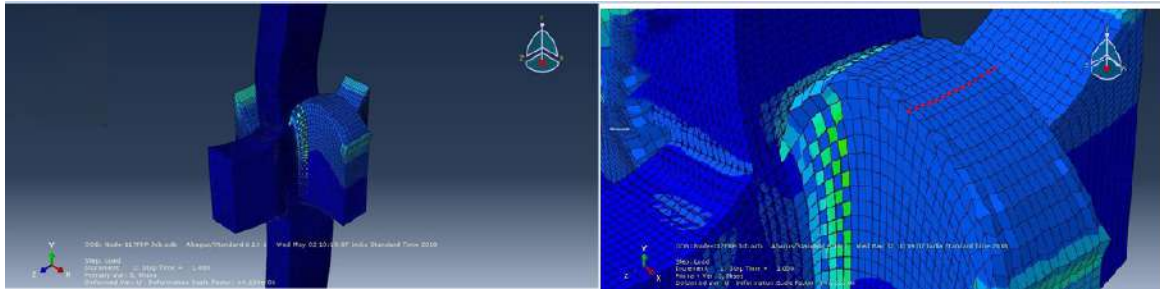


Fig. 8. Deformation after FRP Wrapping with zoomed

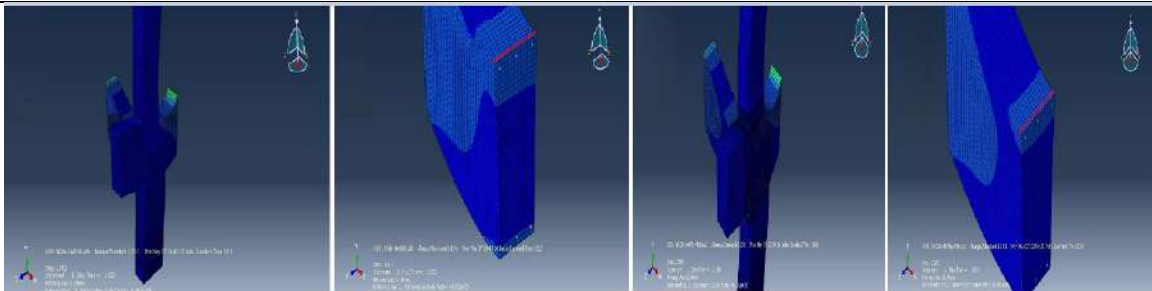


Fig 9: Node of Critical Importance (B,2,4) FRP, after an analysis and a zoomed-in image of the locations selected, Beam Column Joint with Wrapped Beam and After Correction, Zooming in on the Spots.

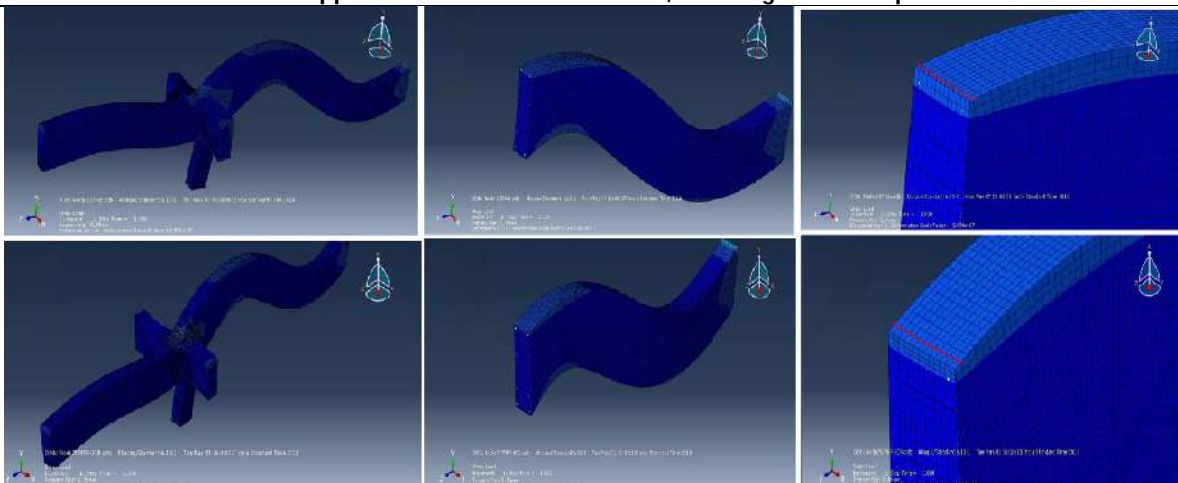


Fig 10 After analysis, the Critical Node (C,2,8) The same section is cut for further steps; the section is zoomed in view of the points chosen. The same section is cut out after the FRP Wrapping is applied; the section is zoomed in on the cut-out section;FRP Wrapped Beam Column Joint after FRP Wrapping; FRP Wrapped Beam Column Joint after FRP Wrapping; FRP Wrapped Beam Column Joint after FRP Wrapping; FRP Wrapped Beam Column Joint after FRP Wrapping; FRP Wrapped Beam Column Joint after FRP Wrapping; FRP Wrapped Beam Column Joint after FRP Wrapping.





## Prevalence and Epidemiological Determinants Influencing Type 2 Diabetes at South India

Alber.M.Mathiarasu<sup>1\*</sup>, S.Sangeetha<sup>2</sup> and R.Rajkumar<sup>3</sup>

<sup>1</sup>Com. Medicine, Research Scholar, Vinayaka Mission Research Foundation, Salem, Tamil Nadu, India.

<sup>2</sup>Com. Med, HOD, Dept of Com Medicine, V.M.K.V.Medical College & Hospital, Salem, Tamil Nadu, India.

<sup>3</sup>Com. Med, Dept of Com. Medicine, Meenakshi Medical College & Research Institute, Kancheepuram, Tamil Nadu, India.

Received: 04 Dec 2021

Revised: 30 Dec 2021

Accepted: 19 Jan 2022

### \*Address for Correspondence

#### Alber.M.Mathiarasu

Com. Medicine, Research Scholar,  
Vinayaka Mission Research Foundation,  
Salem, Tamil Nadu, India.

Email: albermathiarasu@gmail.com



This is an Open Access Journal / article distributed under the terms of the **Creative Commons Attribution License** (CC BY-NC-ND 3.0) which permits unrestricted use, distribution, and reproduction in any medium, provided the original work is properly cited. All rights reserved.

### ABSTRACT

Diabetes mellitus, chronic hyperglycemic metabolic disorders affected 77 million Indians and projected 134 million by 2045. My BCC intervention is cost-effective to reduce the DM burden in India. To determine the Epidemiological factors influencing type 2 Diabetes Mellitus in South India. To identify the prevalence of type 2 Diabetes Mellitus in South India. (CTRI/2019/09/021122, Reg 09/09/2019 Trial Registered Prospectively). A Community Based Cross-Sectional Study design. All individuals between 20 years to 79 years of the age of both sex and permanent residence of Kanyakumari District satisfying inclusion criteria. A multistage stratified, clustered sampling technique. WHO STEPS wise approach to chronic disease risk factor surveillance- Instrument v2.1. Data collected from 01/01/2021 to 30/06/2021 was done. (n) = Z<sup>2</sup>(p) (q) /d<sup>2</sup> and 650 in urban with P- 14% and 1150 in rural with P-8% and total 1800 samples. Percentage, Mean, Chi-square test. linear regression analysis by SPSS version 26.0. 286 Type 2 DM patients identified, Urban P-20.92% and Rural P-13.04 % . Epidemiological Determinants with the Constant value of -0.115 , standard error 0.082 in Physical in activity , Overweight & obesity , Employment status, Family history of Diabetes , Housing type, Tobacco usage, Alcohol intake, Hypertension , Dyslipidemia ,Male sex ,Urban residents shown statistically significant association with type 2 DM since the calculated p value less than 0.05 level. The prevalence of Type 2 DM has increased in the last 5 yrs from 14% to 20.92 % at Urban and from 8 % to 13.04 % in rural. This concludes sudden surge in type 2 DM patients among both urban & rural Indian population which needs early intervention among above significant epidemiological factors to control the progression of the disease.



**Alber.M.Mathiarasu et al.,****Key words:** Community Cross Sectional Study , Prevalence., Type2DM , Epidemiological determinants,

## INTRODUCTION

Diabetes mellitus (DM) is a group of metabolic disorders characterized by chronic hyperglycemia associated with disturbances of carbohydrate, fat and protein metabolism . TYPE 2 DM is a) Predominantly insulin resistance b) Predominantly insulin secretory defects .In 2020, according to the International Diabetes Federation (IDF), 463 million people have diabetes in the world and 88 million people in the Southeast Asia region and in this 77 million belong to India [1] . The number is projected to grow by 2045 to become 134 million per the International Diabetes Federation [2]. Only about one-third of type 2 diabetics in India are overweight or obese [3]. The prevalence of type 2 diabetes in Indians may be due to environmental and lifestyle changes resulting from industrialization and migration to urban environment from rural [4]. High prevalence of diabetes is reported in economically and epidemiologically advanced states such as Tamil Nadu and Kerala [5]. The IDF has stressed the urgency to develop and implement multi-sectoral strategies to combat the growing epidemic. Indians are at high risk for diabetes, which calls for an urgent action plan through intensive efforts to promote lifestyle behavior modifications during the pandemics of both communicable and non communicable diseases. According to ICMR-INDIAB study , One out of 10 people in Tamil Nadu is diabetic and every two persons in a group of 25 are in the pre-diabetic stage. Hence this study to identify the current prevalence of Type 2 DM patients among rural Indian population which needs early intervention to control the progression of the disease and thus reduce the burden of DM in India.

**Aims:** 1. To determine the Epidemiological factors influencing type 2 Diabetes Mellitus in South India.  
2. To identify the prevalence of type 2 Diabetes Mellitus in South India.

### Ethical Clearance

(CTRI/2019/09/021122 [Registered on: 09/09/2019] - Trial Registered Prospectively )

1. Approval has been obtained from Institutional Research Committee of Vinayaka Mission University on April 10<sup>th</sup> 2018.
2. Approval was obtained from Ethical committee at Kanyakumari Govt Medical college , Kanyakumari District on April 12<sup>th</sup> 2018 prior to commencement of the study.
3. Permission letter for Data Collection has been given by The Director of Public Health and Preventive Medicine, Teynampet , Chennai on Jan 2021.
4. Written informed consent has been obtained from study participants after ensuring that they understood and accepted their role in the study

## MATERIAL AND METHODS

**Study Design:** A Community Based Epidemiological Cross-Sectional Study of adults of either sex, aged 20 years to 79 years, aimed at estimating the prevalence of diabetes of Type 2 DM in urban and rural population .

**Study population:** This study was conducted in the urban and rural population in Kanyakumari District which is the southernmost district situated at Tamilnadu state ,South India .

**Sampling :** A multistage stratified, clustered sampling technique using the 2011 census were used. A three-stage design were applied in urban areas and two-stage sampling design in rural areas were done. All individuals between 20 years to 79 of age of both sex and permanent residence of Kanyakumari District are involved in the study . In the Rural Area of kanyakumari District Stratified into regions containing contiguous Blocks . In each region, sub-stratification based on village population size & female literacy rate. In each stratum, villages selected by PPS method (50 villages selected / District). In each village, 56 Households –selected by systematic sampling







**Alber.M.Mathiarasu et al.,**

(sample size in rural area 1150 ;  $1150/50= 23$ ) , 1 individual selected from each household using WHO KISH table . In the Urban areas of Kanyakumari District , Stratified into regions containing contiguous Administrative Block. In each region, sub-stratification done based on town population size & female literacy rate. In each stratum, wards selected by PPS method (50 wards selected / District ). In each ward All Census Enumeration Blocks (CEB) listed, 1 CES selected from each ward by random selection . In each CES All households listed. 24 households –selected by systematic sampling.(sample size in urban areas 650:  $650/50= 13$ ) . One individual will be selected from each house through WHO KISH method.

**Sample size calculation:** The sample size was calculated separately for urban and rural areas as previous studies show large variations in urban and rural prevalence of type 2 diabetes mellitus.

**Sample size (n) =  $Z^2(p)(q) / d^2$  ;**

Z= Z statistic for a level of confidence. For the level of confidence of 95%, the conventional Z value is 1.96 {2 SD} ,p= prevalence or proportion of the aspect being studied in the population, q= (1-p) , d= relative error of the estimated prevalence. Assuming an expected prevalence of 14% in urban areas and 8% in rural areas, allowing a relative error of 20% on these, a non response rate of 20% and an alpha error of 5%, the sample size was estimated to be 650 in urban areas and 1150 in rural areas in each of the regions studied with a total of 1800 individuals.

#### **Inclusion Criteria**

All adults (both men & women) aged between 20 years and 79 years. Usual resident of the Kanyakumari district. Willing to provide written consent to participate in the study. Mentally stable to provide the details required for the study.

#### **Exclusion Criteria :**

Those who are seriously ill at the time Data collection .Not willing to provide written consent for the study.

**Data collection :** Data collection from 01/01/2021 to 30/06/2021 was done in the target population by cluster sampling. The tools used for data collection was WHO STEP wise approach to chronic disease risk factor surveillance- Instrument v2.1 [6].

#### **Description Of “Who Steps” Tool**

The WHO STEPwise approach to noncommunicable disease risk factor surveillance (STEPS). World Health Organization 20 Avenue Appia, 1211 Geneva 27, Switzerland [www.who.int/ncds/steps](http://www.who.int/ncds/steps) ;



#### **STEPS Question-by-Question (Q-by-Q) Guide**

The tool used for data collection consists of 3 parts,

Part 1 : Socio Demographic Data

Part 2 : Physical Measurements,

Part 3 : Biochemical Tests

**Statistical analysis used:** With 95% confidence intervals, Categorical variables were summarized using proportions and continuous variables using mean or median, Multiple linear regression analysis done for association between demographic and dependant variable .SPSS version 26.0 were used for Statistical analysis .

## **RESULTS**

A total of 286 Type 2 DM patients were identified out of target 1800 Study samples by the multi stage cluster sampling technique at kanyakumari district , Urban samples has the prevalence of 136 out of 650 samples



**Alber.M.Mathiarasu et al.,**

contributing Type 2 DM prevalence of 20.92% and Rural samples has prevalence of 13.04%.

This table 2 & 3 shows the results of Chi square test which were computed to find out the association between the Epidemiological Determinants and dependant variables type 2 DM / Non DM . This test result reveals, the Epidemiological Determinants Rural & Urban, Religion, Socioeconomic Status ,Employment Status, Education status , Overweight & obesity, Family history of Diabetes, Housing type, Tobacco usage, Alcohol intake, More Fruits & vegetables servings, Physical Inactivity, Hypertension , Dyslipidemia, shows the p value lower than the significant value of 0.05 level, chi square values were more than the table. Hence there were statistically significant association between the epidemiological determinants Rural & Urban, Religion, Socioeconomic Status, Employment Status, Education status , Overweight & obesity , Family history of Diabetes , Housing type, Tobacco usage, Alcohol intake, More Fruits & vegetables servings , Physical Inactivity, Hypertension , Dyslipidemia, and Type 2 DM .The above findings not support the null hypothesis which stated there were no association between the epidemiological determinant and Type 2 DM . Since the findings proved statistically significant association between the above selected epidemiological determinants and Type 2 DM, the researcher reject the null hypothesis and accepts the research hypothesis.

This table 4 shows Binary Logistic Regression Analysis , With the Constant value of -0.115& Exp (B) referred to as an odds ratio and standard error 0.082, the ODDS of the Epidemiological Determinants were as follows , Physical Inactivity Odds Ratio 9.49 , Alcohol intake Odds Ratio 8.317 , Hypertension Odds Ratio 8.225 , Tobacco usage Odds Ratio 4.755 , Employment status Odds Ratio 2.745 , Housing type Odds Ratio 2.390, Family history of Diabetes Odds Ratio 1.855 , Dyslipidemia Odds Ratio 0.630 , Over weight & Obesity Odds Ratio 0.544 , Urban/Rural Odds Ratio 0.295 , Sex Odds Ratio 0.089 shown statistically significant association with type 2 DM since the calculated p valve less than 0.05 level . Other Epidemiological Determinants like Age category , Socio economic status, Education status, Religion, More vegetables servings , Processed food with high salt intake were not statistically significant to type 2 DM since the calculated p valve was more than 0.05 level .

## DISCUSSION

Type 2 diabetes mellitus has been identified as one of the most challenging chronic illnesses to manage. In this study ,Urban samples has the prevalence of 20.92% and Rural samples has prevalence of 13.04%.This is alarming increase in the prevalence of type 2 DM at both urban and rural compared to urban prevalence of 14% and rural prevalence of 8% before 5 years. Logistic regression model confirms the epidemiological determinants such as the Urban/Rural , Sex, Over weight & obesity , Employment status , Family history of Diabetes , Housing type, Tobacco usage, Alcohol intake, Physical Inactivity, Hypertension , Dyslipidemia shown statistically significant association with type 2 DM . Physical Inactivity predictor was positive and significant (b= 9.49.s.e =0.253, P value 0.000 which is significant at 0.01 level).The regression slope for Physical Inactivity shows each one unit increase on this variable, the log-odds of a case falling into type 2 DM was predicted to increase by 9.49 units . This results suggest that Physical Inactivity were at greater risk of becoming type 2 DM patients as compared to moderate exercise individuals . For Alcohol intake, the odds ratio was 8.317 indicating that with increasing scores on this predictor, the odds of falling into type 2 DM as changing by a factor of 8.317. Similarly Hypertension predictor was positive and significant (b=8.225.s.e =0.296, P value 0.000 which is significant at 0.01 level). The Odds Ratio was 8.225 indicating that with increasing Hypertension value, type 2 DM changed by a factor of 8.225 . These results suggested that HT patient were at greater risk of becoming type 2 DM as compared to Controlled HT patients. In the Binary Logistic Regression Analysis , Tobacco usage predictor was positive and significant (b= 4.755, s.e = 0.359, P value 0.000 which is significant at 0.01 level) and the odds of falling into type 2 DM as changing by a factor of 4.755 . It concluded higher smoking were at greater risk of becoming type 2 DM patient. Employment status predictor was again positive and significant (b= 2.745 . s.e =0.174, P value 0.000 which is significant at 0.01 level) with the odds ratio of 2.745 . This result suggested that Unemployed were at greater risk of becoming type 2 DM patient as compared to

38493



**Alber.M.Mathiarasu et al.,**

employed . Housing type predictor was positive and significant ( $b=2.390$  .s.e =0.727, P value 0.00 which is significant at 0.01 level).The odds ratio was 2.390 . This shows each one unit increase on this variable, the log-odds of a case falling into type 2 DM was predicted to increase by 2.39 units. This was due to the sedentary life style nature of individuals living at pucca house and spending of more time in their work without burning out extra energies. Regarding family history of Diabetes , the odds ratio was 1.855 indicating that with increasing scores on this predictor, the odds of falling into type 2 DM as changing by a factor of 1.855. These results suggested individuals with family history of Diabetes were at greater risk of becoming type 2 DM as compared to non family history of Diabetes individuals.

Similarly Dyslipidemia predictor was positive and significant ( $b=0.630$  .s.e =0.215, P value 0.031 which is significant at 0.05 level). The Odds Ratio was 0.630 indicating that with increasing Dyslipidemia value, type 2 DM changed by a factor of 0.630. These results suggested that Dyslipidemia patient were at greater risk of becoming type 2 DM as compared to Non Dyslipidemic individuals. In the Binary Logistic Regression Analysis , Over weight & Obesity predictor was positive and significant ( $b= 0.544$ , s.e = 0.211, P value 0.004 which is significant at 0.05 level) and the odds of falling into type 2 DM as changing by a factor of 0.544 . It concluded more Over weight & Obesity individuals were at greater risk of becoming type 2 DM patient . Pertaining to place of residence, urban/rural predictor was again positive and significant ( $b= 0.295$  .s.e = 0.324, P value 0.000 which is significant at 0.01 level) with the odds ratio of 0.295 . This result suggested that Urban residents were at greater risk of 0.295 times becoming type 2 DM patient as compared to rural residents . Sex predictor was positive and significant ( $b= 0.089$  .s.e =0.348, P value 0.00 which is significant at 0.01 level).The odds ratio was 0.089 . It concluded males were at greater risk of becoming type 2 DM patient than females with the odds of 0.089.

This findings are supported by the following studies. Moien Abdul Basith Khan [7], et al concluded that the gender distribution is equal, and the incidence peaks at around 55 years of age. Global prevalence of type 2 diabetes is projected to increase to 7079 individuals per 100,000 by 2030, reflecting a continued rise across all regions of the world. Zeru, M.A.et al [8] in his Ethiopian review concluded that the prevalence of type-2 DM was high. Factors like: Older age, illiteracy, cigarette smoking,  $MBI \geq 25$ , family history of DM, history of hypertension and physical inactivity were an identified risk factors of type-2 DM and hence the health education and promotion will be warranted. Andrew P Hills et al [9] proved that an increasing proportion of children, adolescents, and women are overweight or obese, leading to a heightened risk of type 2 diabetes. Artur Kot was [10], et al in his Poland study on Epidemiological factors for type 2 diabetes mellitus: evidence from the Global Burden of Disease concluded at the data from the *Global Burden of Disease* study, the differences between observed and expected years of life lost (YLL), years lived with disability(YLD ), Disability-adjusted life years (DALY) figures for type 2 diabetes have been diminishing in recent years. Milibari AA, Matuure EY [11] et al in their systemic review at Saudi Arabia explored that the prevalence of T2D rates from 1.3% to over 50%. Furthermore, having an unhealthy lifestyle such as poor diet and nutrition/ lack of physical activity was the most common determinant within the population, communities and hospital-based settings especially. The highest risk factors are stroke, high blood pressure and negligence towards healthy living. Awad, S.F, Huangfu [12] et al in their Jordan study proved that the proportion of T2DM incident cases attributed to obesity was 55.6% in 1990, 59.5% in 2020, and 62.6% in 2050. Meanwhile, the combined contribution of smoking and physical inactivity hovered around 5% between 1990 and 2050. Jordan's T2DM epidemic is predicted to grow sizably in the next three decades, driven by population ageing and high and increasing obesity levels.

Vanesa Bellou, Lazaros Belbasis [13], Ioanna Tzoulaki, Evangelos Evangelou risk factors for type 2 diabetes mellitus: an exposure-wide umbrella review of meta-analyses captured 86 eligible papers (142 associations) covering a wide range of biomarkers, medical conditions, and dietary, lifestyle, environmental and psychosocial factors. Adiposity, low hip circumference, an unhealthy dietary pattern (increased consumption of processed meat and sugar-sweetened beverages, decreased intake of whole grains, coffee and heme iron, and low adherence to a healthy dietary pattern), low level of education and conscientiousness, decreased physical activity, high sedentary time and duration of television watching, low alcohol drinking, smoking, air pollution, and some medical conditions (high



**Alber.M.Mathiarasu et al.,**

systolic blood pressure, late menarche age, gestational diabetes, metabolic syndrome, preterm birth) presented robust evidence for increased risk of T2DM. Steven M. Haffner [14] in his Studies of the prevalence of type 2 diabetes in Mexican Americans and non-Hispanic whites in San Antonio showed that there is an inverse relationship between socioeconomic status and the prevalence of diabetes. It also appears that cultural effects lead to an increased incidence of obesity in these populations, which may lead to insulin resistance. Tripathy, J.P., Thakur, J.S., Jeet, G. et al [15]. Indian study concluded that the age group (45–69 years), marital status, hypertension, obesity and family history of DM were found to be the risk factors significantly associated with DM. Out of all persons with DM, only 18% were known case of DM or on treatment, among whom only about one-third had controlled blood glucose status. The study reported high prevalence of diabetes, especially of undiagnosed cases amongst the adult population, most of whom have uncontrolled blood sugar levels. Zhang Hongyan, Ni Jingxian [16] et al in their China study concluded that there was no significant sex-based difference in DM prevalence (men, 14.1%; women, 14.5%). Overweight, obesity, high triglyceride levels, and hypertension were independent risk factors for DM in both sexes. However, high-density lipoprotein-cholesterol levels were negatively associated with DM risk among men [odds ratio (OR), 0.544; 95% confidence interval (CI), 0.355–0.833;  $P = 0.005$ ]. Among women, advanced age and high low-density lipoprotein-cholesterol levels were independent risk factors for DM; there was a higher DM risk for women aged 55–74 years than for those aged 45–54 years; however, physical activity was associated with an increased risk of DM (OR, 1.705; 95% CI, 1.195–2.432;  $P = 0.003$ ).

Worku Animaw, Yeshaneh Seyoum [17] concluded that the both mean blood glucose level and the prevalence of diabetes mellitus were significantly higher for urban residents than rural. Urban dwellers, centrally obese, overweight, and hypertensive individuals have higher odds of getting diabetes mellitus. Keshavarz, Sina & Gholipour, Kamal & Pezeshki et al [18] in their epidemiological Study of Diabetes and its Risk Factors in East Azerbaijan, Iran estimated the crude prevalence of diabetes to be 10.6% (95% CI: 8.7-12.7). The peak prevalence of diabetes was reported among participants between 55 and 64 years. Residence in urban areas (OR: 2.2, 95% CI: 1.4-3.4), family history of diabetes mellitus (OR: 2.6, 95% CI: 1.63-4.66) and past history of hypertension (OR: 1.6, 95% CI: 1.2-3.1) were most strongly associated with diabetes mellitus ( $p < 0.001$ ). Shiferaw Birhanu Aynalem and Ayalew Jejaw Zelek [19] in their Ethiopian study concluded that the prevalence of DM was found to be 6.5%. Of which, the proportion of previously undiagnosed diabetes mellitus was 88.5%. The prevalence of prediabetes was also found to be 15.9%. The waist circumference (WC), body mass index, smoking habit, hypertension, and total cholesterol level were significantly associated with diabetes mellitus. Razzak Abdul Hira, Harbi Alya [20] UAE systemic review of Electronic 24 database found the major determinants of Diabetes Mellitus involved hypertension, physical inactivity, sedentary lifestyle, and unhealthy diet. The epidemiological implications of some of the risk factors including family history, educational level, and the use of alcohol remain elusive. Jaya Prasad Tripathy, J. S. Thakur, Gursimer Jeet et al [21] concluded Overall prevalence of DM among the study participants was found out to be 8.3% (95% CI 7.3–9.4%) whereas prevalence of prediabetes was 6.3% (5.4–7.3%). Age group (45–69 years), marital status, hypertension, obesity and family history of DM were found to be the risk factors significantly associated with DM. Solanki Niti, Virk Amrit, Gupta B.P et al [22] Punjab, India shown the Overall prevalence of DM was 10.0% (7.4% in Rural & 12.6% in Urban Area) with known DM being 6.9% of study population and undiagnosed DM being 3.1% subjects. Significant association was seen between prevalence of DM and age, Obesity and Hypertension. It was observed that the prevalence of DM is higher in urban area as compared to Rural Area. Adults with age >40 years, Obesity and Hypertension are more likely to develop Diabetes Mellitus.

Nagarathna Raghuram et al [23], Indian study (the Indian diabetes risk score IDRS, that has 4 factors age, family history of diabetes, waist circumference, and physical activity) concluded the prevalence of high (IDRS score > 60), moderate (IDRS score 30–50), and low (IDRS < 30) diabetes risk in young adults (<35 years) was 10.2%, 33.1%, and 56.7%, respectively. Xu G, Liu B, Sun Y et al [24] in their US population based study found the weighted prevalence of diagnosed type 2 diabetes among US adults was 9.7%, type 2 diabetes was more prevalent among older adults, men, and those with lower educational level, lower family income level and higher body mass index (BMI). Wu Y, Ding Y, Tanaka Y et al [25] concluded the prevalence of type 2 diabetes has been increasing exponentially, and a high prevalence rate has been observed in developing countries and in populations undergoing “westernization” or



**Alber.M.Mathiarasu et al.,**

modernization. Chen L, Magliano DJ [26] et al found Type 2 diabetes mellitus (T2DM) and prediabetes are increasingly observed among children, adolescents and younger adults. The causes of the epidemic of T2DM are embedded in a very complex group of genetic and epigenetic systems interacting within an equally complex societal framework that determines behavior and environmental influences. Chege MP [27] in Risk factors for type 2 diabetes mellitus among patients attending a rural Kenyan hospital concluded Childhood starvation and use of cassava for sustenance during childhood starvation Diabetes in close relatives, diabetes in a first-degree relative and abdominal obesity were identified as risk factors.. Sabir Anas Ahmad, Balarabe Salisu et al [28] in Nigerian study concluded the overall prevalence of DM was 4.3% (males 4.5% and females 4.0%). Obesity and increasing age were the major risk factors for DM among the suburban population.

Mc Donald Posso, A.J., Bradshaw Meza et al [29] in Panama study found prevalence was 9.5% (10.3% men and 9.1% women), again higher in urbanized regions, but also in males, older adults. Obesity, abdominal obesity, physical inactivity, family history of diabetes, high blood pressure, and triglycerides  $\geq 150$  mg/dL were associated as risk factors for diabetes in both genders . Total cholesterol  $\geq 200$  mg/dL and high-density lipoprotein cholesterol  $< 40$  mg/dL were risk factors in men . Widyahening, I., Kayode, G et al [30] an Indonesian ecological study confirmed three country characteristics independently associated with diabetes prevalence were hypertension and obesity . There is a considerable geographical variation in diabetes prevalence across Asian countries.

## CONCLUSION

Over the past three decades, the number of people with diabetes mellitus has more than doubled globally, making it one of the most important public health challenges to all nations. In this study, Urban samples has the prevalence of 20.92% and Rural samples has prevalence of 13.04% which has been drastic increase in the prevalence of type 2 DM at both urban and rural in last 5 years. Epidemiological Determinants Physical Inactivity, Alcohol intake, Hypertension, Tobacco usage, Employment status, Housing type, Family history of Diabetes, Dyslipidemia, Over weight & Obesity , Urban/Rural , Sex shown statistically significant association with type 2 DM . All are positive odds and modifiable risk factors were also identified. It also concluded that Physical Inactivity were at greater risk of nine times to become type 2 DM patients as compared to moderate exercise individuals. Alcoholics has 8.317 times more chance of falling into type 2 DM than non alcoholics. HT patient were at greater risk of eight times more to become type 2 DM as compared to normotensive individuals. Smokers has four times increased risk to be type 2 DM than non smokers. It concluded Unemployed were at approximately three times greater risk of becoming type 2 DM patient as compared to employed. Residents in pucca house have two times more risk of becoming type 2 DM patient. This was due to the sedentary life style nature of individuals living at pucca house and spending of more time in their work without burning out extra energies. Individuals with family history of Diabetes were at two times increased risk of becoming type 2 DM as compared to non family history of Diabetes individuals. Over weight & Obesity individuals, Dyslipidemics, Urban residents , male sex were at greater risk of becoming type 2 DM than their counterparts. Therefore, targeting the prevention strategy to such modifiable risk factors might reduce the prevalence of diabetes mellitus and screening of DM particularly in those individuals having above risk factors needs attention.

## ACKNOWLEDGEMENTS

"I thank you Lord, with all my heart, I sing praise to you before the Gods. I face your holy Temple, bow down, and praise your name because your constant love and faithfulness". Psalms:138. I extend my sincere thanks and gratitude to the Respected Director of Public Health and Preventive Medicine , Beloved Dean VMKVMC , Joint Directors Epidemics and Training Teynampet and the Deputy Director VMRF Salem for and guidance for this study. I extent my respectful gratitude to Prof. Dr.S.Sangeetha,MD Community Medicine, HOD ,Dept of Community Medicine ,VMKVMC, Salem & Co- guide, Prof. Dr.R.Rajkumar, MD Community Medicine Ph.D, who is my Guide for thier





**Alber.M.Mathiarasu et al.,**

support and successful completion of this study. I express my gratitude to Research Committee Dr.S.R.Renga Bhasyam MD and ,Dr.Shankar MD Com med VMKVMC, Salem and Dr.SureshBalan & other Ethical committee members, KGMC,Asaripalam for laying strong foundation in molding this research. I also express my deep sense of gratitude to my wife Dr. Majella Livingston Alber M.Sc.(N), Ph.D.and my children John Prasad Alber & Jain Prasad Alber for their co-operation in this study.

## REFERENCES

1. Kannan, Ramya (2019-11-14). "India is home to 77 million diabetics, second highest in the world". The Hindu. ISSN 0971-751X. Retrieved 2020-04-29.
2. Geoffrey Migiro (October 25, 2018). "Countries By Percentage Of World Population". World Atlas. Retrieved May 19, 2020
3. Editor (2019-01-15). "Over 30 million have now been diagnosed with diabetes in India. The CPR (Crude prevalence rate) in the urban areas of India is thought to be 9 per cent". Diabetes. Retrieved 2020-04-29.
4. Mohan, V. (June 2004). "Why are Indians more prone to diabetes?". The Journal of the Association of Physicians of India. 52: 468–474. ISSN 0004-5772. PMID 15645957. ^ "Members". idf.org. Retrieved 2020-04-29
5. The increasing burden of diabetes and variations among the states of India: the Global Burden of Disease Study 1990–2016. *Lancet Glob Health*. 2018; 6: e1352-e1362
6. WHO STEPwise approach to chronic disease risk factor surveillance- Instrument v2.1
7. Khan MAB, Hashim MJ, King JK, Govender RD, Mustafa H, Al Kaabi J. Epidemiology of Type 2 Diabetes - Global Burden of Disease and Forecasted Trends. *J Epidemiol Glob Health*. 2020;10(1):107-111.
8. Zeru, M.A., Tesfa, E., Mitiku, A.A. et al. Prevalence and risk factors of type-2 diabetes mellitus in Ethiopia: systematic review and meta-analysis. *Sci Rep* 11, 21733 (2021). <https://doi.org/10.1038/s41598-021-01256-9>
9. Hills AP, Arena R, Khunti K, Yajnik CS, Jayawardena R, Henry CJ, Street SJ, Soares MJ, Misra A. Epidemiology and determinants of type 2 diabetes in south Asia. *Lancet Diabetes Endocrinol*. 2018 Dec;6(12):966-978.
10. Kotwas, A., Karakiewicz, B., Zabielska, P. et al. Epidemiological factors for type 2 diabetes mellitus: evidence from the Global Burden of Disease. *Arch Public Health* 79, 110 (2021). <https://doi.org/10.1186/s13690-021-00632-1>
11. Milibari AA, Matuure EY, Gadah EM (2020) Prevalence, Determinants and Prevention of Type 2 Diabetes Mellitus (T2DM) in Arabic Countries: A Systematic Review Study. *Health Sci J*. Vol. 14 No. 2: 701
12. Awad, S.F., Huangfu, P., Dargham, S.R. et al. Characterizing the type 2 diabetes mellitus epidemic in Jordan up to 2050. *Sci Rep* 10, 21001 (2020).
13. Vanesa Bellou, Lazaros Belbasis, Ioanna Tzoulaki, Evangelos Evangelou risk factors for type 2 diabetes mellitus: an exposure-wide umbrella review of meta-analyses Published: March 20, 2018 <https://doi.org/10.1371/journal.pone.0194127>
14. Steven M. Haffner; Epidemiology of Type 2 Diabetes: Risk Factors. *Diabetes Care* 1 December 1998; 21 (Supplement\_3): C3–C6. <https://doi.org/10.2337/diacare.21.3.C3>
15. Tripathy, J.P., Thakur, J.S., Jeet, G. et al. Prevalence and risk factors of diabetes in a large community-based study in North India: results from a STEPS survey in Punjab, India. *Diabetol Metab Syndr* 9, 8 (2017).
16. Zhang Hongyan, Ni Jingxian, Yu Changshen, Wu Yanan, Li Jingyan, Liu Jie, Tu Jun, Ning Xianjia, He Qing, Wang Jinghua ,Sex-Based Differences in Diabetes Prevalence and Risk Factors: A Population-Based Cross-Sectional Study Among Low-Income Adults in China ,*Frontiers in Endocrinology* vol 10 ,2019, pages 658
17. Worku Animaw, Yeshaneh Seyoum , Increasing prevalence of diabetes mellitus in a developing country and its related factors , November 7, 2017 ,<https://doi.org/10.1371/journal.pone.0187670>
18. Keshavarz, Sina & Gholipour, Kamal & Pezeshki, Mohammad & Zeinalzadeh, Alihossein & Seyyed Hashemi Toloun, Mohammad. (2013). Epidemiological Study of Diabetes and its Risk Factors in East Azerbaijan, Iran. *Journal of Pioneering Medical Sciences*. 3.
19. Shiferaw Birhanu Aynalem and Ayalew Jejaw Zelek, International Journal of Endocrinology, Vol 2018 | ArticleID 9317987 | <https://doi.org/10.1155/2018/9317987>





**Alber.M.Mathiarasu et al.,**

20. Razzak Abdul Hira , Harbi Alya , Shelpai Wael and Qawas Ahmad , Epidemiology of Diabetes Mellitus in United Arab Emirates, *Current Diabetes Reviews* 2018; 14(6)
21. Jaya Prasad Tripathy , J. S. Thakur, Gursimer Jeet , Sohan Chawla , Sanjay Jain , Arnab Pal , Rajendra Prasad and Rajiv Sara, Prevalence and risk factors of diabetes in a large community-based study in North India: results from a STEPS survey in Punjab, India, *Diabetol Metab Syndr* (2017) 9:8 DOI 10.1186/s13098-017-0207-3
22. Solanki Niti , Virk Amrit , Gupta B.P, Singh Jasdeep ,Prevalence and Risk Factors of Diabetes Mellitus among Adults residing in Field Practice Area of a Teaching Hospital in Punjab, *Healthline Journal* Volume 6 Issue 1 (January - June 2015)
23. Nagarathna Raghuram, Bali Parul, Anand Akshay, Srivastava Vinod, Patil Suchitra, Sharma Guruprasad, Manasa Krishna, Pannu Viraaj, Singh Amit, Nagendra Hongasandra R.,Prevalence of Diabetes and Its Determinants in the Young Adults Indian Population-Call for Yoga Intervention ,*Frontiers in endocrinology* vol-11, 2020.pages 846
24. Xu G, Liu B, Sun Y, Du Y, Snetselaar LG, Hu FB, Bao W. Prevalence of diagnosed type 1 and type 2 diabetes among US adults in 2016 and 2017: population based study. *BMJ*. 2018 Sep 4;362:k1497. doi: 10.1136/bmj.k1497. PMID: 30181166
25. Wu Y, Ding Y, Tanaka Y, Zhang W. Risk Factors Contributing to Type 2 Diabetes and Recent Advances in the Treatment and Prevention. *Int J Med Sci* 2014; 11(11):1185-1200. doi:10.7150/ijms.10001
26. Chen L, Magliano DJ, Zimmet PZ. The worldwide epidemiology of type 2 diabetes mellitus--present and future perspectives. *Nat Rev Endocrinol*. 2011 Nov 8;8(4):228-36. doi: 10.1038/nrendo.2011.183. PMID: 22064493.
27. Chege MP. Risk factors for type 2 diabetes mellitus among patients attending a rural Kenyan hospital. *Afr J Prm Health Care Fam Med*. 2010;2(1), Art. #96, 5 pages. DOI: 10.4102/phcfm.v2i1.96
28. Sabir Anas Ahmad, Balarabe Salisu, Sani Abubakar Atta, Isezuo Simeon A, Bello Kabiru Sada, Jimoh Abdulgafar O, Iwuala Sandra O Prevalence of diabetes mellitus and its risk factors among the suburban population of Northwest Nigeria Year : 2017 | Volume: 20 | Issue Number: 4 | Page: 168-172
29. Mc Donald Posso, A.J., Bradshaw Meza, R.A., Mendoza Morales, E.A., Jaen, Y., Ortega, A.C. and Mendoza Posada, E.J., 2016. Diabetes in Panama: Epidemiology, Risk Factors, and Clinical Management. *Annals of Global Health*, 81(6),754–764.
30. Widyahening, I., Kayode, G., Wangge, G. and Grobbee, D. 2019. Country Characteristics and Variation in Diabetes Prevalence among Asian Countries – an Ecological Study. *Journal of the ASEAN Federation of Endocrine Societies*. 34, 1 (Jul. 2019), 80.

**Table 1 : General Characteristics Of 286 Diabetic Subjects**

S.No	Demographic Variable	Category	Frequency (F)	Percentage (%)
1	SEX	Male	80	28
		Female	206	72
2	RELIGION	Hindu	141	49.3
		Christian	141	49.3
		Muslim	4	1.4
3	CASTE	SC	2	0.7
		ST	1	0.3
		OBC	233	81.5
		Others	50	17.5
4	AGE CATECORY	1.20 to 39 yrs	26	9.1
		2.40 to 59 yrs	175	61.2
		3.60 to 79 yrs	85	29.7
5	MARITAL STATUS	1.Unmarried	4	1.4
		2.Married	249	87.1





**Alber.M.Mathiarasu et al.,**

		3. Widowed	28	9.8
		4. Separated	5	1.7
<b>6</b>	EDUCATION STATUS	1. Illiterate	18	6.3
		2. High School	122	42.7
		3. Bachelor Degree	102	35.7
		4. Professional	44	15.4
<b>7</b>	PLACE OF RESIDENCE	1. Urban	136	47.6
		2. Rural	150	52.4
<b>8</b>	SOCIOECONOMIC STATUS	1. APL	181	63.3
		2. BPL	105	36.7
<b>9</b>	EMPLOYMENT STATUS	1. Unemployed	36	12.6
		2. Employed	152	53.1
		3. Homemaker	89	31.1
		4. Retired	9	3.1
<b>10.</b>	HOUSING TYPE	1. Pucca	189	66.1
		2. Semi Pucca	85	29.7
		3. Kutcha	12	4.2

**Table 2: Shows the Association between the Epidemiological Determinants and DM / Non DM Subjects**

EPIDEMIOLOGICAL DETERMINANTS	SUB CATEGORY	FREQUENCY		CHI SQUARE VALUE	df	P VALUE
		DM	NON DM			
PLACE OF RESIDENCE	URBAN	136	514	19.293	1	<0.001
	RURAL	150	1000			
SEX	Male	80	315	0.221	1	0.690
	Female	206	1199			
AGE CATEGORY	21 to 40 yrs	56	376	3.656	2	0.161
	41 to 60 yrs	161	801			
	51 to 70 yrs	69	337			
RELIGION	HINDU	141	746	11.632	2	0.003
	MUSLIM	4	42			
	CHRISTIAN	141	726			
OVERWEIGHT/ OBESITY	YES	99	654	7.280	1	0.004
	NO	187	860			
EDUCATION STATUS	ILLITERATE	23	69	9.324	3	0.025
	HIGHER SECONDARY	122	663			
	DEGREE	97	595			
	PROFESSIONAL	44	187			
DYSLIPIDEMIA	YES	150	1108	49.152	1	<0.001
	NO	136	406			
SOCIOECONOMIC STATUS	APL	254	834	116.96	1	<0.001
	BPL	32	677			







**Alber.M.Mathiarasu et al.,**

**Table 3: Shows the Association between the Epidemiological Determinants and DM / Non DM Subjects**

EPIDEMIOLOGICAL DETERMINANTS	SUB CATEGORY	FREQUENCY		CHI SQUARE VALUE	df	P VALUE
		DM	NON DM			
FAMILY HISTORY OF DIABETES	Yes	132	194	180.29	1	<0.001
	No	154	1320			
CIGRATTE SMOKING	Yes	91	195	223.06	1	<0.001
	No	195	1446			
FRUITS & VEGETABLES SERVINGS PER DAY	1	13	102	121.71	5	<0.001
	2	123	823			
	3	10	163			
	4	38	260			
	5	77	126			
	6	25	40			
HOUSING TYPE	Pucca	216	1061	6.136	2	0.047
	Semi Pucca	68	450			
	Kutcha	2	3			
ALCHOLOL CONSUMPTION	Yes	83	162	68.669	1	<0.001
	No	203	1352			
EMPLOYMENT STATUS	Unemployed	63	156	110.99	3	<0.001
	Employed	197	749			
	Homemaker	23	590			
	Professional	2	19			
EATING PROCESSED FOOD HIGH IN SALT / DAY	1	39	214	17.530	5	0.004
	2	195	925			
	3	6	125			
	4	15	105			
	5	30	144			
	6	1	1			
HYPERTENSION	Yes	157	427	78.193	1	<0.001
	No	129	1087			
Physical Inactivity	Yes	180	123	516.25	1	<0.001
	No	106	1391			

**Table 4 : Shows Association Between Epidemiological Determinants And Type 2 DM After Binary Logistic Regression Analysis**

Epidemiological Determinants	B	S.E.	Wald	df	Exp(B)	Sig.
Residence 1.Urban 2.Rural	-1.221	.324	14.227	1	.295	.000
Sex 1.male 2.female	-2.416	.348	48.282	1	.089	.000
Age Category	-.051	.181	.078	1	.951	.780
Overweight/Obesity 1.Yes.2.No	-.608	.211	8.304	1	.544	.004
Education status	.261	.144	3.291	1	1.298	.070
Religion	.109	.104	1.093	1	1.115	.296

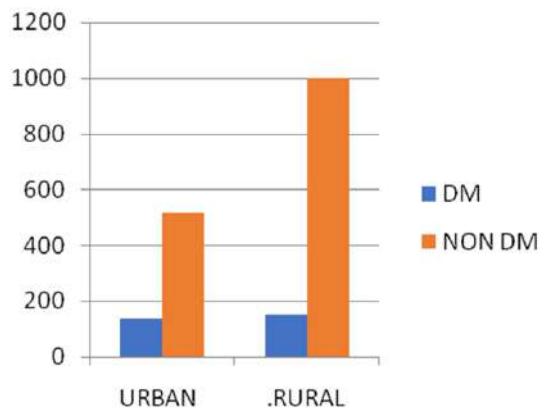




**Alber.M.Mathiarasu et al.,**

Marital status	.385	.290	1.768	1	1.470	.184
Employment Status	1.010	.174	33.697	1	2.745	.000
APL/BPL	-2.947	3.028	.947	1	.053	.330
Housing Type	.871	.239	13.292	1	2.390	.000
Family Histry diabetes	.618	.243	6.458	1	1.855	.011
Smoking tobacco	3.907	.359	118.50	1	4.755	.000
Consumed alcohol	2.118	.362	34.183	1	8.317	.000
Hypertension 1.Yes 2.No	2.107	.296	50.689	1	8.225	.000
Dyslipidemia1.Yes 2.No	-.462	.215	4.626	1	.630	.031
Physical Inactivity	-2.970	.253	137.70	1	9.49	.000
Adding salt to food per day	-.031	.077	.165	1	.969	.684
Serving fruit&Vegetable / day	-.090	.088	1.041	1	.914	.308
Constant	-15.67	2.172	52.123	1	.000	.000

(P <0.05 significant)



**Fig 1: shows the distribution among Diabetic & Non Diabetic subjects among Urban and Rural study population**





## EPCR: Energy Proficient Cluster-Based Routing Protocols in Wireless Sensor Networks

Kannan K<sup>1\*</sup>, Rajeshkumar M<sup>2</sup> and Tamilselvan.A.P<sup>2</sup>

<sup>1</sup>Assistant Professor and Head, PG and Research Department of Computer Science, Kaamadhenu Arts and Science College, Sathyamangalam, Erode, Tamil Nadu, India.

<sup>2</sup>Assistant Professor, PG and Research Department of Computer Science, Kaamadhenu Arts and Science College, Sathyamangalam, Erode, Tamil Nadu, India.

Received: 05 Dec 2021

Revised: 31 Dec 2021

Accepted: 24 Jan 2022

### \*Address for Correspondence

#### Kannan K

Assistant Professor and Head,  
PG and Research Department of Computer Science,  
Kaamadhenu Arts and Science College,  
Sathyamangalam, Erode,  
Tamil Nadu, India.



This is an Open Access Journal / article distributed under the terms of the **Creative Commons Attribution License** (CC BY-NC-ND 3.0) which permits unrestricted use, distribution, and reproduction in any medium, provided the original work is properly cited. All rights reserved.

### ABSTRACT

A wireless sensor network (WSN) is a network having a wireless transmission medium in which autonomous devices are geographically deployed to monitor physical or environmental changes using micro sensors. Since the last few years, WSN has captivated many academics with their novel ideas for extending the life of sensor nodes. Battery power plays a critical role in extending the life of these sensor nodes. Numerous academics have shown that hierarchical routing protocols are the most well-known protocols for minimizing energy use. By using evolutionary techniques, the optimization of hierarchical clustering may be improved even more. The proposed energy-efficient cluster-based routing protocols (EPCR) method beat an efficient K-DS algorithm in this article when it came to lowering the cost associated with force usage imposed by the number of dynamic nodes in a WSN. This routing system is a hybrid of cluster-based and multipath routing techniques. We organize the network's sensor nodes into tiny clusters. Each of these clusters is associated with a CH. Nodes inside a cluster transmit data to the Cluster Head assigned to them (CH). Direct communication is used to convey data between nodes and CH. Each CH sends data to the sink or base station. This data transport occurs through multipath routing.

**Keywords:** K-DS, WSN, CH, EPCR, Energy Proficient, Multipath



**Kannan et al.,**

## INTRODUCTION

WSNs have the capacity to monitor both military and civilian areas. The ability to add distant sensing points without running wires leads in a variety of advantages, including energy and material reductions, process improvements, labor cost savings, and increased productivity [1]. WSN has been highlighted as a developing technology in the realm of wireless communication in recent years. In general, WSNs are composed of a large number of tiny and inexpensive sensor nodes with limited processing power and storage that are distributed in the monitored region and form a network by self-organization [2]. The nodes are capable of communicating directly with the base station (BS) or with one another. Currently, sensors of this kind are evaluated for applications requiring minimal power, reliable data transmission, short range communication, and a relatively cheap cost [3]. In comparison to conventional ad hoc networks, routing in WSNs is more difficult due to their intrinsic properties. To begin, resources in terms of power supply, computational capabilities, and transmission bandwidth are severely restricted. Second, designing a global addressing scheme such as Internet Protocol (IP) is challenging [4]. Today, inexpensive wireless sensor nodes with enough computing, transmission, and receiving capabilities are available [5].

This enhancement enables the deployment of hundreds of nodes in a network for any application. However, routing and data gathering from these deployed nodes are challenging due to their low power [6]. As a result, the most significant problems for academics include developing a WSN routing protocol, increasing the WSN's energy efficiency, and prolonging the WSN's lifespan [7]. The routing protocols used in current WSNs may be classified according to their route establishment, network topology, and protocol operation. The development of paths is classified as proactive, reactive, or hybrid based on the network's reaction to sensed input. There are three types of network structure: location-based (geographic), hierarchical (clustering), and flat networks (data centric) [8]. Numerous routing techniques have been suggested for successful routing in WSNs. Cluster-based routing is a well-known routing technology in which sensor nodes self-organize into tiny clusters and then pick a CH. Sensor nodes detect the needed parameters and transfer them to the CH, which is responsible for collecting sensed data from its cluster members and aggregating it before sending it to the base station [9]. Numerous contemporary clustering strategies are based on homogenous WSNs in which all sensor nodes have the same battery capacity. In a heterogeneous WSN, on the other hand, two or more distinct kinds of sensor nodes with varying battery capacities are employed. When applied to heterogeneous WSNs, the energy-saving strategies designed for homogeneous WSNs do not function well.

As a result, novel energy-efficient clustering procedures should be developed to account for the diverse nature of WSNs [10]. Adding a few more capable sensor nodes may significantly boost the network's longevity and stability at a negligible cost increase [12]. As a result of the above, heterogeneous WSNs are becoming more essential and are being employed in a broad range of applications, making study in this field very desired [13]. Recently, heterogeneous networks have garnered more interest from academics than homogeneous networks, owing to the fact that when used to real-world applications such as habitat target tracking, monitoring, and disaster assistance, heterogeneous WSNs outperform homogeneous WSNs [14][15]. Our work is applicable to a WSN deployed in a battlefield, where sensor nodes must be provided with a variety of energy supplies in order to fulfill diverse functions. The following paper is organized. Section 2 discusses related work, Section 3 discusses the EPCR methodology and design, Section 4 discusses the results and discussion, and Section 5 discusses the conclusion and future work.

## BACKGROUND STUDY

Ademola P Abidoye et al. (2011) proposed a novel clustering method for choosing the CH that consumes the least amount of energy during data transmission. The energy used is spread equally across the cluster's nodes. Two distinct forms of data transfer occur here. The first is a single-hop data transfer between the SN and the CH, whereas the second is a multi-hop data transmission between the CH and the BS. Energy and electricity are critical components of WSNs. The goal of clustering is to provide the resources required for WSN activities while



**Kannan et al.,**

minimizing the amount of energy used by the nodes. Eslaminejad and Razak (2012) conducted a comprehensive review of WSNs, stressing the major processes involved in lifespan extension through routing. Additionally, the authors provided a full description of techniques and shed light on several unresolved research topics. Davis and Chang (2012) conducted a study of WSN architectures. They divided WSN designs into several classes based on the behavior and features of data flow. The presently available architectures were analyzed using a variety of factors. Additionally, the pros and downsides of each instance were discussed.

Khan et al. (2014) enhanced an energy-conscious environmental monitoring and conservation application that can be used to monitor a region's temperature and humidity. They created a model and a shortest route method to do this. Rahman and Matin (2011) concentrated on determining the ideal location of the sink. Along with the standard sensor nodes, several relay nodes were included to help alleviate hotspot difficulties near the sink. They employed a particle swarm optimization technique to determine the ideal sink position. Rather of directly communicating with the BS, the relay node connects with the sink. According to the authors, this strategy saved up to 40% of energy and prolonged the life of the network. Manfredi (2012) enhanced the energy efficiency and reliability of a previously developed cooperative routing method for wireless monitoring applications. The redesigned scheme's effect was examined using a network simulator. On the basis of dependability and energy efficiency, the improved method was compared to the Ad-hoc On-Distance Vector, shortest non-cooperative route, and minimum-power cooperative routing algorithms. Umadevi (2016) presented a technique for WSNs called Energy-Efficient Clustering and Random Data Aggregation (EECRA). Clusters that are unprejudiced and high in energy are to be bred. Due to the fact that clusters located near to the base station promote statistics from clusters located farther away, their energy might be rapidly depleted. To address this issue and extend the network's lifetime, the cluster's radius is gradually increased. The radius of the cluster is determined by the detachment from the base station. The procedure of cluster selection is confined to SNs located near to the cluster's core that have the highest exceptional energy and the greatest number of neighbors. To minimize communications and save the sensors' energy, each CH selects a selection of nodes and combines their data. Wang et al. (2013) investigated the scalability implications of several static sinks. They modified and verified an approach for energy-efficient multi-sink clustering. The effect of node density, node location, and mobile sink velocity was investigated, and an energy-efficient clustering technique based on mobile sinks was presented. Both of these protocols are appropriate for use in consumer home network environments, according to validations conducted using simulations.

## SYSTEM MODEL

Based on the distance factor in the first component, the network nodes have been split into inner and outer zones. Route maintenance has been undertaken to detect problematic connections in the routing routes that have been built and to reduce the likelihood of route breakages and re-transmissions. The protocol automatically modifies forwarders based on measurable measurements, which may result in increased network lifespan and route dependability. Each node has a stable, unique identity. The nodes have similar qualities and are constrained by a few restrictions; however the sink node has the most powerful features and is not constrained by any constraints. Route maintenance has been conducted to reduce the likelihood of route damage and re-routing. If the EPCR determines that a CH in the upper zone is unsuitable for continued data transmission, it commences the search for an alternative routing channel.

## CLUSTERS FORMATION

The research community has EPCR cluster-based methods for enhancing network scalability, longevity, and communication overheads. These alternatives, however, have been disregarded from a security standpoint, since open media is rife with network risks and criminal activity. The selection of a CH plays a significant role in the cluster formation process, since it is responsible for a variety of additional tasks in addition to its local information collecting. EPCR is an energy-efficient cluster-based routing protocol that employs a secret sharing system based on XOR to provide energy efficiency and reliable forwarding through safe intermediary nodes against data attacks. The EPCR protocol's primary contributions in contrast to other procedures.



**Kannan et al.,**

The EPCR protocol divides the network into inner and outer zones according to their distance. Additionally, each zone has been subdivided into several clusters based on their proximity to the adjacent neighborhood. The objective for such node segmentation is to maximize energy efficiency and network connectivity with the least amount of delay possible. Second, to address security and data privacy concerns among sensor nodes with limited resources, EPCR proposes a lightweight XOR-based secret sharing system. Through XOR mathematical operations, the EPCR secret sharing technique protects data between CHs and BS from hostile nodes in a multi-hop manner, resulting in a trustworthy end-to-end connection. The primary reason for using the XOR operation in the suggested method is to simplify the process of doing measured computations in cryptography. Additionally, XOR encryption is simpler to implement and consumes less processing effort in sensor nodes with restricted resources. Finally, the route maintenance strategy has been successful in minimizing routing interruptions by quantitative analysis of network nodes.

### SECURE ROUTING PROTOCOL

This section discusses an energy-aware and secure multi-hop routing (EPCR) protocol for limited WSNs based on a secret sharing system. All of its components must be explored in depth in the following subsections. Based on the distance factor in the first component, the network nodes have been split into inner and outer zones. Additionally, the nodes inside each zone have been arranged into distinct clusters using the k-Discriminative Structure (k-DS) technique. All clusters have been organized hierarchically to facilitate further data routing. The second component's primary objective is to strike a balance between energy consumption and reliable data forwarding, as well as to provide an energy-efficient multi-hop routing strategy that is safe against malicious attacks. It provides a lightweight solution for restricted sensor nodes based on the XOR secret sharing mechanism. Additionally, it imposes no extra computing burden on the network. Route maintenance was undertaken in the third component to detect problematic connections in the created routing routes and to reduce the likelihood of route breakages and re-transmissions. In this situation, the suggested protocol changes forwarders based on measurable measurements, which may result in increased network lifespan and route dependability. Figure 2 shows the path selection from source to destination. The yellow line has represents the shortest path. But this path has intrusion occur. So, select alternative path represented in figure 4

### REGION BASED ZONES CONSTRUCTION

Nodes have scattered randomly to cover the region the size of a monitoring square. Following deployment, all nodes are assigned unique IDs. The nodes have similar qualities and are constrained by a few restrictions; however the sink node has the most powerful features and is not constrained by any constraints. Initially, the BS uses a multi-hop method to transmit its identification and location information in the sensor field. Each node receives the BS information through their next hop and stores it in their routing tables. Nodes' routing tables have been updated in response to changes in their neighboring circumstances. The inner zone needs less transmission power in order to convey data straight to the BS. However, outer zones make effective use of their higher zones as intermediaries for sensory information transfer. Subsequently, using the lightweight and simple k-Discriminative Structure (k-DS) technique, the created zones were further deconstructed into multiple clusters. By using a low-cost distance function, the K-DS approach was employed to group the closest neighbors into a single cluster. K is defined as the square root of the number of nodes in a certain zone. After decomposing each zone into distinct clusters, each cluster was assigned a unique identity to differentiate it from the other clusters. Additionally, to save network costs, a node that is closer to the central has been designated as the first CH in each cluster. Figure 3 illustrates the initial data transferring from source to destination.

### ROUTE MAINTENANCE

The route maintenance component has been included to reduce the likelihood of route damage and re-routing. If the EPCR determines that a CH in the higher zone is unsuitable for data forwarding, it commences the search for an alternative routing route. The route maintenance procedure, in particular, has triggered the ensuing situations. To begin, anytime the CH's energy resource falls below a set threshold in the upper zone, the impacted CH simply suspends the data forwarding process and re-announces the election process inside a given boundary. Following





**Kannan et al.,**

that, a node that is closer to the centric is chosen as a new CH and its status is updated. Secondly, the established connection between CHs  $L_i$ , performance  $j$ 's has been assessed using the packet delay variation (PDV) metric. The PDV returns an absolute number indicating the difference in transmission rates between two successive packets belonging to the same communication channel. If a packet has been sent and covers the  $t_0$  time required to traverse the network, and another packet has been transmitted and covers the  $t_1$  time required to cross the network, the PDV may be calculated. Figure 4 represents the alternative path when intrusion occurs on primary path. So selecting the alternative path and sending the data.

#### Transaction Key Generation:

All acknowledgement packets must be digitally signed prior to being transmitted and validated until they are approved. However, we are well aware of the additional resources needed by the adoption of digital signatures in WSNs. We applied both techniques to solve this risk. The objective must be to identify the most optimum approach for implementing digital signatures in WSNs. Asymmetric key cryptography solves the key management issue by encrypting and decrypting numerous key pairs in distinct ways. Knowing one key, for example, the encryption key, is insufficient to deduce the second key, the decryption key. As a result, the encryption key may be made public as long as the decryption key is retained exclusively by the person desiring to receive encrypted data (hence the term public/private key cryptography). No one can use a public key to decode another public key or to encrypt a message; only the receiver has the ability to decrypt it.

#### K-Discriminative Structure (k-DS) algorithm

1. Construct the model of a WSN with  $k$  number of nodes.
- 2: Selection of Backup nodes based on energy  $B = \{B_1, B_2, \dots, B_s\}$  where  $s$  has the total number of clusters.
- 3: Formation of the clusters.
- 4: The nodes in a cluster  $i$  has defined as  $C_i = \{n_1, n_2, \dots, n_x\}$  where  $x = N_i$  has the number of nodes in the cluster  $i$ .
- 5: Selection of additional backup nodes ( $Adbi$ ) based on the number of nodes in a cluster with index  $i$  ( $N_i$ )
- 6:  $Adbi = N_i - 2$  where  $i$  has the cluster index and  $1, 2, \dots, s$  have index of cluster.
- 7: selection of initial cluster heads for clusters  $CH = \{CH_1, CH_2, \dots, CH_s\}$  with energies  $E = \{E_1, E_2, \dots, E_s\}$
- 8: Threshold ( $thr$ ) value has defined as  $P(N_i) E(n_i) / (N_i)$  where  $E(n)$   $i$  represents energy of a node  $n$  in cluster  $i$ .
- 9: packet transfer from nodes to CH.
- 10: Aggregation of packets at CH.
- 11: Transfer of aggregated packets from CH to base station.
- 12: if  $E_i \leq thr$  then
- 13:  $CH_i = B_i$
- 14: goto 6

The mathematical link between the public/private key pair enables the following general rule: any message encrypted with a key for one of the pair's slots may be successfully decoded only with the key's counterpart. Encrypting with the public key restricts decryption to the private key for each slot. The opposite is likewise true - encrypting using the private key precludes decrypting with anything other than the public key.

## RESULTS AND DISCUSSION

The experiments were performed in NS2. Different parameters like Average CH switching delay; energy, throughput, number of packets dropped and packet delivery ratio were calculated. These parameters were compared for different topologies with varying number of nodes (0-20) Simulation setting is shown in table 1. Comparisons performed between the Existing Model and EPCR Model has ESMR and EPCR. Figure 5 represents the forwarding packets delay comparison chart. In X-axis denotes the Number of packets forwarding and Y-axis denotes the Total data loss.





**Kannan et al.,**

Figure 6 represents the throughput comparison when Message Load. X-axis denotes the throughput level and Y-axis denotes the Message Load. Figure 7 denotes the comparison chart for Energy level. X axis denotes the packets transmission and Y-axis denotes the average energy consumption. Figure 8 denotes the comparison chart for communication threshold at trust value basis. X-axis denotes the Communication time and Y-axis denotes the Trust value. Figure 9 represents the Energy consumption comparison between existing and EPCR method. X-axis denotes the Delay and Y axis denotes the energy level. Figure 10 denotes the packet delivery ration comparison. X-axis denotes the time and Y-axis denotes the packet Delivery rate. Figure 11 denotes the Throughput comparison chart. X axis denotes the Time and Y-axis denote s the No of packets transmitted.

## CONCLUSIONS

Recent advances in wireless communications have facilitated the creation of low-cost, low-power WSNs with a broad range of applications. Energy efficiency and hence network lifespan extension are critical considerations for the creation of optimal sensor networking protocols and algorithms. This article introduces an EPCR framework for data transfer that is compatible with the K-DS algorithm. When simulation data were evaluated, it was shown that EPCR performed very well and could produce a 20 to 24% improvement over ESMR. This research finds that the procedure is capable of performing well across all measures. This approach is more effective at dissipating energy, it may have a longer delivery delay or a more complicated algorithm; on the other side, if a protocol has a shorter delivery delay or a simpler algorithm, it may be less energy efficient.

## REFERENCES

1. Ademola PAbidoye, NureniA Azeez, Ademola OAdesina & Kehinde KAgbele 2011,' ANCAEE: A Novel Clustering Algorithm for Energy Efficiency in Wireless Sensor Networks', Wireless Sensor Network, vol.3,pp.307-312. no. 1,pp.704-711, 2009.
2. bhattacharyya.,KimT.H.,PalS., "A ComparativeStudy ofWireless Sensor Networks and their Routing Protocols," Sensors,vol.12, no.10, pp.10506-10523,2010.
3. Chin T. L. and Chuang W. C. ,"Latency of Collaborative Target Detection for Surveillance Sensor Networks,"IEEE Transactions On Parallel and Distributed Systems,vol.26,no.2, pp. 467-477,2015.
4. Davis A., Chang H. ,"A Survey of Wireless Sensor Network Architectures," International Journal of Computer Science & EngineeringSurvey,vol.3,no.6,pp. 110-132,2012.
5. Eslaminejad M.and RazakS.A., "Fundamental Lifetime Mechanisms in Routing Protocols for Wireless Sensor Networks: A Survey and Open Issues," Sensors,vol.12, no. 1,pp.13508-13544,2012.
6. Khan P.,GhoshA., Konar G., and Chakraborty N., "Temperature and Humidity Monitoring through Wireless Sensor Network using Shortest Path Algorithm," in Proceedings of the International Conference on Control, Instrumentation, Energy and Communication, pp. 199-203, 2014.
7. ManfrediS., "Reliable and Energy-Efficient Cooperative Routing Algorithm for Wireless Monitoring Systems, "IETWirel. Sens. Syst., vol.2,no.2, p. 128-134,2012.
8. RahmanM.N. and Matin M., "Efficient Algorithm for Prolonging Network Lifetime of Wireless Sensor Networks, "T singhua Sci. Technol., vol.16, no. 6,pp.561-568,2011.
9. Siddhi Sharma et al. 2015,' Artificial Neural Network based Cluster Head Selection in Wireless Sensor Network', International Journal of Computer Applications (0975–8887),vol.119,no.4,pp.34-41.
10. [10] TruongT.T.,BrownK.N.andSreenanC.J., "Using Mobile Sinks in WirelessSensor Networks toImprove BuildingEmergencyResponse," in ProceedingsofRoyallIrishAcademyResearchColloquiumon Wireless as an Enabling Technology,2010.
11. Umadevi,M 2016, 'Energy Efficient Clustering and Random data Aggregation in Wireless Sensor Networks', International Journal of Advanced Research in Computer Science and Software Engineering, vol.6,issue5,pp.98-102.





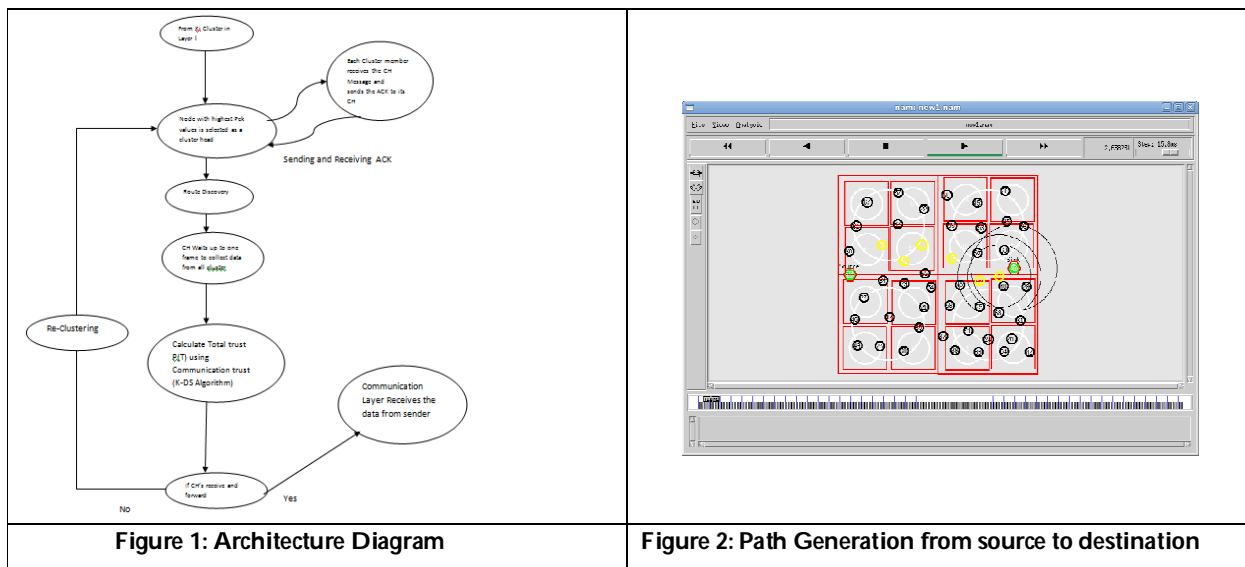


**Kannan et al.,**

12. Wang J.,Yin Y.,Zhang J.,Lee S. and Sherratt R.,“Mobility Based Energy Efficient and Multi- Sink Algorithms for Consumer Home Networks,” IEEE Transactions on Consumer Electronics, vol. 59, no.1, pp.77-84,2013.
13. YickJ., Mukherjee B., and GhosalD., “Wireless Sensor Network Survey,”Computer Networks,vol.52, no. 12,pp.2292-2330,2008
14. ZengY. And Zheng G.,“Delay-BoundedandRobustRoutingProtocolfor Emergency Applications Using Wireless Sensor Networks,”in Proceedings of the 2<sup>nd</sup> Int.Conf. Adv.Comput.Control,no. 2, pp. 37-41, 2010.
15. ZengY., SreenanC.J., and Sitanayah L.,“A Real-Time and Robust Routing Protocol for Building Fire Emergency Applications Using Wireless Sensor Networks,” inProceedingsofthe 8thIEEEInt. Conf. Pervasive Comput. Commun. Work. PERCOM Work,pp. 358-363,2010.

**Table 1: Simulation Parameters**

Parameters	Value
Simulation Time	500(s)
Number of Nodes	0to69
Mobility	10-50m/s
Routing Protocol	DSR
Pause Time	10(m/s)
Simulation Area	550 x480 m
Transmission Range	250m
No. of malicious Node	2





Kannan et al.,

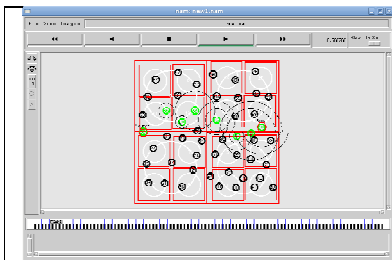


Figure 3 Data Transferring on selected path 1

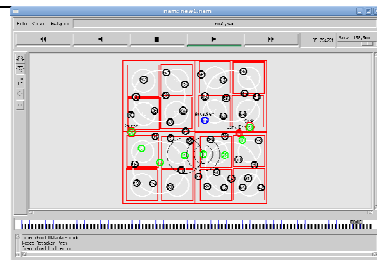


Figure 4 Data transferring on alternative path when intrusion detection

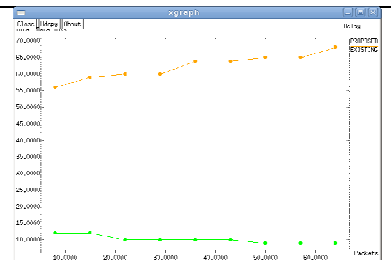


Figure 5: Delay Comparison

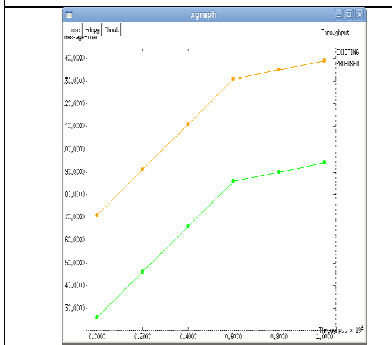


Figure 6: Throughput Comparison

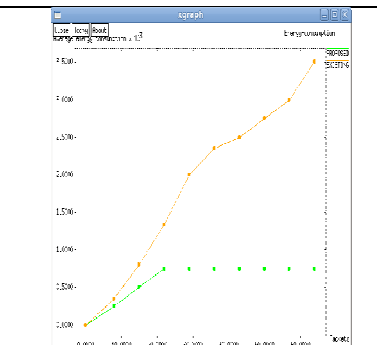


Figure 7: Energy Consumption Comparison

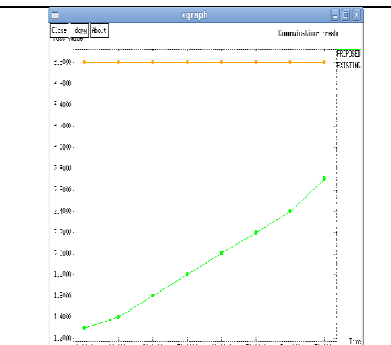


Figure 8: Comparison chart for Communication-Threshold

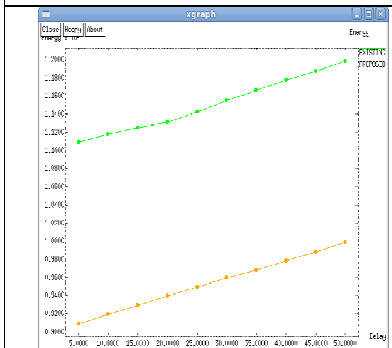


Figure 9: Energy Comparison Chart

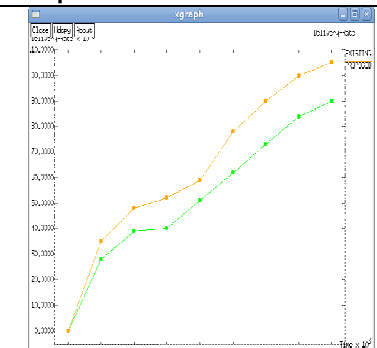


Figure 10: Delivery Ratio Comparison chart

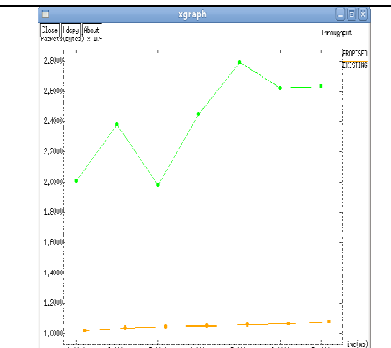


Figure 11: Throughput Comparison chart





## Occurrence, Incidence and Identification of a Potyvirus on Maize in Gorakhpur Division of Eastern Uttar Pradesh

S. Srivastava<sup>1\*</sup> and D.K.Srivastava<sup>2</sup>

<sup>1</sup>Associate Professor, Department of Botany, H. C. P. G. College, Varanasi, UP. 221001, India.

<sup>2</sup>Assistant Professor, Department of Botany, D.C.S.K.P.G. College, Mau, UP. 275101, India

Received: 11 Dec 2021

Revised: 25 Dec 2021

Accepted: 18 Jan 2022

### \*Address for Correspondence

#### S. Srivastava

Associate Professor,  
Department of Botany,  
H. C. P.G. College,  
Varanasi, UP.221001, India.  
Email: sanjaychandravns@gmail.com



This is an Open Access Journal / article distributed under the terms of the **Creative Commons Attribution License** (CC BY-NC-ND 3.0) which permits unrestricted use, distribution, and reproduction in any medium, provided the original work is properly cited. All rights reserved.

### ABSTRACT

A virus disease of maize (*Zea mays* L.) was observed in maize growing areas of Gorakhpur district and its vicinity in 2018– 2019. The disease was predominant and its incidence ranged from 9-35%. Among five districts viz., Gorakhpur, Maharjganj, Siddharthnagar, Kushinagar and Deoria, the highest incidence of the disease (35%) was recorded in Maharajganj district of eastern Uttar Pradesh. The virus was identified on the basis of symptomatology, host range, transmission, physical properties, electron microscopy, serology and histological studies. The virus under study was transmitted by mechanical sap inoculation method and through aphid vectors. Out of five aphid vectors, viz., *Acyrtosiphon pisum*, *Aphis craccivora*, *Myzus persicae*, *Rhopalosiphum maidis*, and *Schizaphis graminum* tested for insect transmission of the causal virus, only four aphids except *A.pisum* could transmit the virus from maize to maize and maize to sorghum cv.MP Chari. The physical properties like thermal inactivation point (TIP), dilution endpoint (DEP) and longevity *in vitro* (LIV) were obtained 55°C, 10<sup>-5</sup> and 7 days, respectively. In DAC-ELISA and ISEM, the virus reacted strongly with polyclonal antisera of maize dwarf mosaic virus (MDMV). Host range studies of the virus revealed that the virus produce systemic symptoms in maize, sorghum, Johnson grass and Sudangrass. It failed to produce mosaic symptoms on plants except the members of family Poaceae. Leaf-dip electron microscopy of the virus showed a flexuous, filamentous virus particle of 715 nm. Reactions on differential plant species showed that the virus could produce mosaic symptoms in Johnsongrass, maize and sorghum lines OKY8, SA8735 and Atlas, whereas sorghum Rio showed necrotic symptoms. Based on these studies, the virus under study was identified as an Indian isolate of maize dwarf mosaic potyvirus.

**Keywords:** Maize (*Zea mays* L.), MDMV, potyvirus, vector, host.





## Srivastava and Srivastava

## INTRODUCTION

In India, the area of land under maize crop, ranks fifth after rice, wheat, sorghum and pearl millet. Maize holds fourth position in grain production. Maize (*Zea mays* L.) has been reported to be infected by a number of plant viruses besides other pathogens. Maize viruses under natural field conditions cause greater damage resulting in high percentage of losses. In India, several maize viruses have been recorded from time to time [1, 2, 3, 4]. A very common virus disease of maize in India has been recorded from maize and Sudangrass [5] and from maize and sorghum [6]. Maize dwarf mosaic virus (MDMV) disease of maize has great significance due to its increasing percentage of infection in Indian crop cultivars. Besides MDMV, other potyviruses like sugarcane mosaic virus (SCMV), Johnson grass mosaic virus (JgMV) and sorghum mosaic virus (SrMV) have also been reported to cause higher biotic stress in maize crops [7,8,9,10]. Surveys conducted in 2018-2019 of maize growing fields in five districts viz., Gorakhpur, Maharjganj, Siddharth nagar, Kushinagar, Deoria of Eastern Uttar Pradesh, revealed the presence of a virus disease exhibiting severe mosaic pattern. Naturally infected plants showed severe mosaic mottle and stunted growth. Maize growing field in concerned areas of research revealed the association of potyvirus like causal agent. The infected plants produced very few seeds and small cobs, with poor kernel fill. In view of these findings, the present study was undertaken to establish the identity of mosaic disease causing pathogen. This paper deals with the distribution, incidence, possible natural reservoirs, modes of transmission, serological relationships and electron microscopy of a potyvirus causing maize mosaic under natural field conditions.

## MATERIAL AND METHODS

**Surveys:** Surveys were conducted in and around Gorakhpur division (Gorakhpur, Maharjganj, Siddharthnagar, Kushinagar and Deoria) of eastern Uttar Pradesh for the presence of virus infection in maize crops. These areas were surveyed during the course of study in two consecutive growing seasons 2018 and 2019. The incidence of mosaic virus disease was recorded. The samples collected from different fields of surveyed areas were tested through mechanical sap inoculation and further by enzyme-linked immunosorbent assay (ELISA) test to confirm the identity of the virus associated with the disease.

**Mechanical Sap Transmission:** The virus culture collected from different commercial maize fields as well as kitchen garden were sap inoculated on fresh seedlings of *Zea mays* L. var. GK-555. The virus culture was maintained on above mentioned maize plants variety GK 555 in an insect proof glass house. The assay host used in all the experiments was maize GK-555. For mechanical transmission of the causal virus, young leaves of maize, showing typical mosaic symptoms were selected for the preparation of standard inocula (SI). The infected leaves, thoroughly washed in running tap water followed by drying between folds of blotting paper, were macerated using sterilized mortar and pestle using 1 ml of buffer per gram of leaf. The buffer used was 0.1 M phosphate buffer (pH 7.0) containing 0.1% sodium diethyl dithiocarbamate (DIECA). The filtrate thus obtained from the pulp was used as a Standard Inoculum (SI).

**Aphid Transmission:** To study, whether the virus causing mosaic disease is insect transmissible, attempts were made using aphid vectors viz., *Acyrtosiphon pisum*, *Aphis craccivora*, *Myzus persicae*, *Rhopalosiphum maidis*, and *Schizaphis graminum*. The fresh cultures of above mentioned aphid vectors were maintained on their pioneer hosts namely *Pisumsativum*, *Brassica oleracea*, *Zea mays* and *Sorghum bicolor*, respectively. The aphids were given pre-acquisition fasting of two hours, an acquisition feeding time of 15 minutes and an infection feeding period of four hours. The number of aphids per plant was five. 10 plants were treated with each aphid species. The plants were placed along with control plants, in an insect proof glasshouse for observations and symptom development.

**Seed Transmission:** Mature seeds from mosaic disease infected GK-555 were collected. In each sowing, 250 seeds were grown in earthen pots, in an insect proof glasshouse. The experiments were repeated three to four times for the



**Srivastava and Srivastava**

confirmation. The plants grown from infected seeds were observed for the development of symptoms up to flowering stage.

**Host Range:** To investigate the possible natural hosts of the virus, 28 species of plants belonging to family Chenopodiaceae, Compositae, Cruciferae, Cucurbitaceae, Labiatae, Leguminosae, Malvaceae, 99 species from family Poaceae and 11 plant species from family Solanaceae were inoculated with the virus under study.

**Serological Tests:** Tube precipitin test was performed employing the method proposed by Matthews [11]. In precipitin test, two dilutions 1:4 and 1:16 of inoculum and control were used with similar dilutions of antisera. In all the dilutions, the antigen and antiserum were made with 0.85% salt (NaCl) in 0.1 M borate buffer and the ratio of antigen and antiserum was 1:1 (v/v). Direct antigen-coated enzyme linked immunosorbent assay (DAC-ELISA) was carried out as per the protocol of Hobbs *et al.* [12]. The polyclonal antisera used were sugarcane mosaic virus (SCMV), Maize dwarf mosaic virus (MDMV), Johnson grass mosaic virus (JGMV), Sorghum mosaic virus (SrMV), Potato virus-Y and Papaya ringspot virus (PRSV)-H str. The antisera were procured from A.G. Gillaspie, USA; M. Tomic, Yugoslavia and D.D. Shukla, Australia. DAC-ELISA was done on polystyrene plates (Corning, USA). Samples were prepared in coating buffer (1:10 dilution w/v) (0.05 M sodium carbonate, pH 9.8). Polyclonal antisera were used at 1:1000 dilution. Anti-rabbit immunoglobulin alkaline phosphate (Sigma) at 1:8000 dilution was used. ELISA reactions were read at 405 nm, 1 hour after adding substrate 1.0 mg/ml (P-nitrophenyl phosphate Sigma) by using Dynatech ELISA reader. Immuno sorbent electron microscopy (ISEM) was done according to protocol of Milne and Lesemann [13]. For the decoration of virus particles 10 µl drop of infected plant tissue extract was used and 10 µl drop of 1:50 antisera was also used. The grid was incubated at 37°C for 30 min. to 1 hr. After washing of grid, 2% aqueous solution of uranyl acetate was used before the observation.

**Electron Microscopy:** Leaf-dip preparation were made for the study of virus particle in the present investigation. Electron microscopy was performed according to the protocol of Brandes [14].

**Infectivity Test:** To study the virus isolate infectivity, three sorghum inbred lines (OKY8, Atlas and Rio), three maize cultivars (GKP 555, GKP 44 and GK 555) and one each of oat and sugarcane (CoS87220) were used as differential hosts. The test plants were mechanically inoculated with the virus under study. The biological reactions were recorded thrice and compared with earlier symptom description [15, 16].

## RESULTS

**Surveys:** During random surveys conducted in five districts of eastern Uttar Pradesh, the maize plants showed severe mosaic mottling of leaves and stunting of the plants. The size of lamina and length of leaf was also found significantly reduced. The incidence of the disease varied between 9-35% in surveyed plots. The highest incidence level of incidence (35%) was observed in the district Maharajganj.

**Transmission:** The virus was found easily transmissible through mechanical sap inoculations. Universal severe mosaic pattern were observed on sap inoculated plant leaves after 25 days of inoculation. The virus was also transmitted by aphid vectors such as *A. craccivora*, *M. persicae*, *R. maidis*, and *S. graminum* in a non-persistent manner. The aphid species, *S. graminum* was found most efficient vector of the virus. However, *Acyrtosiphon pisum* failed to transmit the causal virus. Experimental results on seed transmission of the virus revealed that the virus was not seed borne in nature. However, the infection reduced the viability of seeds obtained from disease plant cobs.

**Host Range:** The studies on host range, showed that the virus was only restricted to family Poaceae. The virus infected 16 sorghum cultivars showing the symptoms such as mild mosaic, severe mosaic, chlorotic streak, tip necrosis and leaf necrosis. The virus also produced symptoms on Sudangrass and Johnson grass. Forty two varieties of maize were found to be infected by the causal virus showing mild and severe mosaic symptoms. All the plants of



**Srivastava and Srivastava**

family Chenopodiaceae, Compositae, Cruciferae, Cucurbitaceae, Labiatae, Leguminosae, Malvaceae and Solanaceae tested were found to be no host of the virus.

**Serological Test:** In tube precipitin test, inoculum gave precipitate only with the antiserum of maize dwarf mosaic virus. It showed negative reactions against other antisera used. No precipitation was obtained with any healthy sap against any antisera tested. In DAC-ELISA, out of six polyclonal antisera tested only polyclonal antisera of MDMV reacted strongly with antigen. No reaction was observed with other antisera used. Immunosorbent electron microscopy of the virus showed a uniform decoration of observed virus particles with MDMV antibodies.

**Electron Microscopy:** Leaf-dip preparations of infected maize leaf revealed the presence of flexuous, filamentous particles with an average length of 715 nm.

**Infectivity Test:** Symptoms on sorghum differentials ranged from severe mosaic to tip necrosis, while maize varieties tested, showed mild to severe mosaic symptoms. However, the causal virus could not infect the Clintland oat variety and sugarcane (CoS87220).

## DISCUSSION

The earlier studies on mosaic disease of maize and sorghum crops in India [3, 5, 6, 17] provide better supports to new discovery of mosaic disease causing potyvirus in Gorakhpur division and its vicinity of eastern Uttar Pradesh. Although there have been very early reports of mosaic disease on maize from India [18] but the virus was identified as SCMV. The virus under study resembles in its host range, physical properties, particle morphology, symptomatology and serology with maize dwarf mosaic virus described earlier [5, 7, 17]. The incidence of mosaic virus disease exhibits close similarity with previous findings [19, 20]. However 100% incidence of similar disease was reported in ideal epidemic conditions [15, 21]. The gradual increase in incidence of present virus in India is a matter of serious concern for maize growing areas. The infectivity test of present virus isolates gave similar reaction with maize, sorghum, sugarcane and oat differentials [16, 22]. The virus under study could react positively with antisera of maize dwarf mosaic virus (MDMV) but failed to react positively against other polyclonal antisera tested. Similar serological reactions have also been reported by various workers [6, 23]. On the basis of above results, the virus prevailing in districts of eastern U.P. has been identified as a strain of potyvirus of maize crop antigenically related to maize dwarf mosaic virus.

## REFERENCES

1. Ahlawat, Y.S. and Raychaudhury, S.P.(1976). Vein enation: A new virus disease of maize in India, Current science, 45(7):273-274.
2. Mishra, M.D. (1994). Viral disease of cereal crops in India and prospects of their management. Indian phytopath. 47(3): 297-298.
3. Singh, C.A.K. (1983). Occurrence of maize dwarf mosaic virus in India. Current science, 52 (17): 818-819.
4. Vasudeva, R.S. (1955). Report of Division of Mycology and Plant Pathology. Sci. Rep. Agric., Inst. New Delhi, 1953-54, pp. 87-89, 1955.
5. Rao, G.P.; Jain, R.K, and Varma, A. (1996). Occurrence of maize dwarf mosaic virus on maize and Sudan grass in India. Plant disease, 80 (6).
6. Rao, G.P.; Jain, R.K, and Varma, A. (1998). Identification of sugarcane mosaic and maize dwarf mosaic potyvirus infecting poaceous crops in India. Indian phytopath., 51(1): 10-16.
7. Angeles, Achon, M. and Sobrepere, M. (2001). Incidence of potyviruses in commercial maize fields and their seasonal cycles in Spain. Zeitschrift fur Pflanzenkrankheiten und Pflanzenschutz, 108 (4): 399-406.
8. Bonga, J. and Cole, D.L. (1997). Identification of viruses infecting maize in Zimbabwe. African Plant Protection Bulletin, 3(1): 1-9. Crop Science Department. Univ. of Zimbabwe.





### Srivastava and Srivastava

9. Krstic, B. and Tosic, M. (1995). Sugarcane mosaic virus-an important pathogen on maize in Yugoslavia. *Zeitschrift fur Pflanzenkrankheiten and Pflanzenschutz*, 102 (1): 34-39.
10. Parsely, D.M.; Henzell, R.G.; Greber, R.S.; Teakle, D.S. and Toler, R.W. (1985). Use of a set differential sorghum and maize in nine countries. *Plant disease*, 69 (12): 1046-1049.
11. Matthews, R.E.F. (1957). *Plant virus serology*. 127pp. Univ. Press, London and New York.
12. Hobbs, H.A., Reddy, D.V.R., Rajeshwari, R. and Reddy, A.S. (1987). Use of direct coating and protein A coating ELISA procedure for detection of three peanut viruses. *Plant Dis.* 71: 747-749.
13. Milne and Lesemann, D.E. (1984). *Methods in virology* (eds. K. Maramorosch & Koprowski), Academic press, New York, 1984, 8: 81-85.
14. Brandes, D., Zetterqvist, H. & Sheldon, H. *Histochemical Techniques for Electron Microscopy: Alkaline Phosphatase*. *Nature* 177, 382-383 (1956). <https://doi.org/10.1038/177382a0>
15. Tosic, M.; Krstic, B. and Jankovic, D. (1990 a). Epidemijskapojavomozaicnekizlijavostkukuruzu u Jugoslaviji. *Zastita Bilja*, 191: 81-93.
16. Shukla, D.D. and Ward, C.W. (1994). Recent developments in identification and classification of virus comprising the sugarcane mosaic subgroup of potyviruses. *Current Trends in sugarcane Pathology* (Eds, Rao, G.P. et al.). International book and periodical supply service, New Delhi, India. Pp.185 – 198.
17. Mishra, Madhulika; Rao, G.P. and Upadhyay, P.P. (1998). Identification and characterization of maize dwarf mosaic potyvirus in India. *Indian J. Virol.* 14(1): 75-79.
18. Chona, B.L. and Seth, M.D. (1960). A mosaic disease of maize in India. *Indian J. Agric. Sci.* 30: 25-32.
19. Chen Zhijie, Zhang Shulian, Zhang Meirong and Lei Hong (1995). Investigation on the occurrence of maize virus disease in Shaanxi. *Plant protection*, 21 (2): 14-15.
20. Fuchs, E., Gruntzig, M. and Kuntze, L. (1994). Virus disease of maize now also in Germany. *Institut fur Phytopathologie und Pflanzenschutz, Mais No. 4*, 140-143.
21. Hohmann, F., Fuchs, E., Gruntzig, M. and Oertel, U. (1999). A contribution to the ecology of sugarcane mosaic potyvirus (SCMV) and maize dwarf mosaic potyvirus (MDMV) in Germany. *Zeitschrift fur Pflanzenkrankheiten und Pflanzenschutz*, 106(3): 314-324.
22. McDaniel, L.L. and Gordon, D.T. (1985). Identification of a new strain of maize dwarf mosaic virus. *Plant disease*, 69(7): 602-607.
23. Tosic, M.; Krstic, B.; Ford, R.E. and Rao, G.P. (2001). Analysis of the serological relationships among sugarcane mosaic, maize dwarf mosaic, Johnsongrass mosaic and sorghum mosaic potyviruses. *Sugarcane Pathology*, Vol.2: Virus and Phytoplasma diseases, 223-233pp.





Srivastava and Srivastava



plate 3: Immunosorbent Electron Micrograph of MDMV Particles



Plate 4: Electron Micrograph of Maize dwarf mosaic virus (MDMV) under Transmission Electron Microscope







## Perception among Parents on Gut Related Hypersensitiveness in Autistic Children – A Cross Sectional Analysis

Sumitha Hemavathy P<sup>1\*</sup>, Ramya K<sup>2</sup> and Senthilkumar M<sup>2</sup>

<sup>1</sup>Director, CAPAAR (Center for Advanced Paediatric and Adult Rehabilitation), Bangalore, Karnataka, India.

<sup>2</sup>Director, Barath Physio Care, Salem, Tamil Nadu, India.

Received: 14 Dec 2021

Revised: 03 Jan 2022

Accepted: 17 Jan 2022

### \*Address for Correspondence

**Sumitha Hemavathy P**

Director,

CAPAAR (Center for Advanced Paediatric and Adult Rehabilitation),

Bangalore, Karnataka, India.

Email: drsenthilramya@gmail.com



This is an Open Access Journal / article distributed under the terms of the **Creative Commons Attribution License** (CC BY-NC-ND 3.0) which permits unrestricted use, distribution, and reproduction in any medium, provided the original work is properly cited. All rights reserved.

### ABSTRACT

The purpose of the study is to determine the awareness among the parents of autistic children about the gut related issues that cause constipation and the role of physiotherapy exercises in decreasing the frequency of constipation and enhancing the gastrointestinal mobility of autistic children. A cross sectional analysis was conducted at various centers of Bangalore and also across India among the parents of autistic who attended therapy sessions. A special questionnaire with 10 closed ended questions was framed by two experienced therapist in the same field and was circulated. Among the 472 responses recorded 57 were excluded on the basis of irrelevant or partial answering. Remaining 415 were considered for results. The results of the study showed that most of the children (53%) were affected by constipation and the frequency was more than thrice which puts the health of the children under stake. And also the results showed the chewing habit had a major role in gastrointestinal mobility. The parents were very much unaware that the pelvic and abdominal exercises can reduce the frequency of constipation. Hence a concrete protocol should be set to show up the visibility of exercises in improving gastrointestinal mobility.

**Keywords:** Autism, gastrointestinal mobility, Constipation in autism, exercise for constipation.

### INTRODUCTION

Autism is an alarmingly increasing global neuro developmental problem that affects not only the individual and family but also the society and nation. Autism Spectrum disorder is defined as a developmental disorder characterized by difficulty in social interaction and communication. It is manifested as repetitive patterns of thoughts and behavior.[1] One third of Indian population constitutes children under 15 years. This counts to 1.3 billion of the

38516



**Sumitha Hemavathy et al.,**

total population of India. It is estimated that around 2 million people are affected by autism in the year 2019[2]. There is a possibility of the prevalence to increase exponentially in next 10 years. Many reasons contribute to the causes which includes both genetic and societal reasons. Autism spectrum disorder presents with a wide stretch of symptoms ranging from difficulty in speech and communication, difficulty in interaction and expression, exhibiting unusual behaviors or repetitive behaviors. Apart from this delay in motor development, cognitive and learning skills, sensory processing issues and gastro intestinal are pertaining much scope as these corrections and adjustments help the children to adapt themselves into the world as socially acceptable. The role of physiotherapy in addressing the motor and sensory issues of autistic children has gone a long way in RETRAINING the children. But the gastro intestinal dysfunction is not addressed properly. In fact the child exhibits obsessive behavior or repetitive behavior like stimming whenever there is poor movement of bowel. It is observed that 49% of the children reported one or more chronic GI complaints, 22% exhibited diarrhea, 26% suffered from constipation. Furthermore 13% of the parents reported their children to suffer from bloating and/or being gassy and while 10% of the parents reported vomiting or gastroesophageal reflux problems [3]. The role of physiotherapy treatment and exercise is yet to be explored in addressing the gastrointestinal issues. The awareness among the parents of autistic children about the role of exercise that can improve the peristaltic movement and lessen the episode of diarrhea is much less. This study aims at addressing the perception of gut related hypersensitiveness among autistic children and how abdominal and pelvic floor exercises can increase the gastro intestinal mobility and reduce the occurrence of diarrhea. Three senior physiotherapists working in the field of paediatric were included in designing the questionnaire that was used in this study.

**METHODS**

A cross sectional analysis was conducted among the parents whose children attended therapeutic session for autistic spectrum disorder in Bangalore. Also the questionnaire was circulated to various centers throughout India and was answered online. The questionnaire was specifically designed for this study by two experienced physiotherapist who had vast experience in the field of paediatric and autism in specific. However the questionnaire did not include any ranking or rating. And hence the validity and reliability need not be evaluated prior to administering the questionnaire. Appropriate consent was taken from the parents and their response was recorded either by themselves or by an assistant. The study was conducted for a period of 15 months from August 2020 to October 2021. The criteria to participate in the survey was any parent or adult whose child has been diagnosed for autistic disorder and who are under some therapeutic treatment for the same. The parents/adult are informed in prior about the aim of the study and the responses were marked based on their personal observation over a period of time. To avoid bias post-test analysis was done by three senior physiotherapists to find out the relevancy in answering. After careful scrutinization the data was analyzed. As the data were nominal in nature the study results were displayed as percentages.

**RESULTS**

472 responses were recorded of which 57 were excluded – 15 were incomplete, 7 were partially answered, 12 were not autistic children and 23 were answered without interest. Hence 412 responses were taken into final consideration and analyzed. The average mean of the participants was 6.5 years with 247 male and 225 female. The questionnaire is represented in table 1 and the flow chart of the study is displayed in figure 1. The results of main questions are displayed in figure 2 -8.

**DISCUSSION**

The study was performed to analyze the perception among parents on gut related sensitiveness in autistic children in Bangalore and various cities across India who were under therapeutic treatment. The primary aim of the study was to analyse the awareness among parents about the child's gastrointestinal problem especially constipation and chewing



**Sumitha Hemavathy et al.,**

techniques. It also analyze how far the parents are aware of the role of physiotherapy in rectifying the gut related issues and the role of pelvic floor exercises and abdominal muscle strengthening in increasing the gastrointestinal mobility thereby reducing the frequency of constipation. The first question aimed at identifying the child's habit of licking objects, floor wall or chew dress, collar or toys. The result showed that 37% of children had the habit of licking objects around them and 42% had the habit of munching the dress either the collar or hand cuff of shirts. Habit of licking objects is an early identifiable symptom exhibited by autistic children.[4]. The second question aimed at establishing a relationship between eating habits and being choosy over foods. 72% of children exhibited being picky in nature in eating common foods like crunchy foods and fruits. The third question showed the interrelation between chewing habits and oromotor functions. Only 12% of parent have reported that their child chewed the food completely. Whereas 56% has reported there is no proper chewing habit in the child. Though 32% were being observed to show chewing to certain extent which shows a significant development of mastication muscles. A study observed to analyze the chewing performance and feeding behavior among 56 autistic children revealed a  $p = 0.0014$  in autistic children and  $p = 0.0001$  in developing children which showed worse chewing function and meal time function and a need to address the issue early[5]. The next question in order witnessed a great number of children depicting wrong chewing technique. 58% Of children were observed chewing from front of the teeth compared to 31% of their counterparts who chewed from back of the teeth. This is real problem need to be addressed by the physiotherapists to address the mastication muscles to help in complete emptying of bowel.

The fifth question exhibited 72% of children showing unusual behavior like gagging, vomiting or over eating during intake of certain foods. Among this 22% revealed frequent bloating of stomach and 32% frequent gas or flatulence. 16% revealed soiling irrespective of the places they are in which puts a stigma to social behavior among parents. And 18% reported noticing vomiting or nausea. Feeding issues and food selectivity often have a behavioral etiology, suggesting a neurobehavioral etiology that led to higher incidence of gastrointestinal symptoms in autistic children [6]. The seventh question related directly to the constipation frequency in children as observed by the parents who reported that 21% of children experienced constipation atleast twice a week and 23% thrice a week. But 56% on the contrary said the constipation symptom persisted almost daily which shows a significant strain on the motility of intestinal tract. Studies revealed 8.5% of patients who attended Paediatric surgical constipation clinic had autism and causes could be in born and related to genetic origin in such children [7]. ATN Gastroenterology Committee identified subtle or atypical symptoms that indicate the presence of constipation and screening, identification and treatment through deliberate approach with careful follow up in reducing the incidence of constipation [8]. A study between 2006 to 2014 reported 15% more visits by autistic children into the emergency department for constipation against the 10.6% of normal children and cited a need for effective outpatient management of the problem [9]. The eighth question related to the signs the children exhibit before toileting or as they feel the urge to defecate. 36% showed stiffening or squeezing of buttocks and 27% applied pressure over the abdomen and 24% exhibited tightening or crossing of thighs. A significant higher percentage of autistic children with higher severity showed anxiety problems, somatic complaints as behavioral issues [10]. The most neglected part was the awareness among parents about the effect of pelvic floor exercises and abdominal exercises on improving gastrointestinal mobility. 83% reported they were unaware of the exercise which shows sufficient light should be thrown in the view of physiotherapy exercises for abdomen in improving gastrointestinal mobility and reducing frequency of diarrhea. The last question was on specific diet which was observed that 37% were on gluten free casein free diet and 33% on yeast free diet. The results of the study very translucently says that there is lack of understanding on the role of abdominal exercises and pelvic floor exercises on improving gastrointestinal motility and reducing frequency of constipation and thereby improving the quality of life of autistic children.

**REFERENCES**

1. Block ME, Block VE, Halliday P. What Is Autism?. Teaching Elementary Physical Education. 2006 Nov;17(6):7-11.
2. Krishnamurthy V. A clinical experience of autism in India. J DevBehavPediatr. 2008 Aug;29(4):331-3. doi: 10.1097/DBP.0b013e3181829f1f. PMID: 18698197.





**Sumitha Hemavathy et al.,**

3. Kang V, Wagner GC, Ming X. Gastrointestinal dysfunction in children with autism spectrum disorders. *Autism Res.* 2014 Aug;7(4):501-6. doi: 10.1002/aur.1386. Epub 2014 Apr 21. PMID: 24753336.
4. Hoshino Y, Kumashiro H, Yashima Y, Tachibana R, Watanabe M, Furukawa H. Early symptoms of autistic children and its diagnostic significance. *Psychiatry and Clinical Neurosciences.* 1982 Dec;36(4):367-74.
5. Şahan AK, Öztürk N, Demir N, Karaduman AA, Arslan SS. A Comparative Analysis of Chewing Function and Feeding Behaviors in Children with Autism. *Dysphagia.* 2021 Jan 11:1-6.
6. Ibrahim SH, Voigt RG, Katusic SK, Weaver AL, Barbaresi WJ. Incidence of gastrointestinal symptoms in children with autism: a population-based study. *Pediatrics.* 2009 Aug 1;124(2):680-6.
7. Afzal N, Murch S, Thirrupathy K, Berger L, Fagbemi A, Heuschkel R. Constipation with acquired megarectum in children with autism. *Pediatrics.* 2003 Oct 1;112(4):939-42.
8. Afzal N, Murch S, Thirrupathy K, Berger L, Fagbemi A, Heuschkel R. Constipation with acquired megarectum in children with autism. *Pediatrics.* 2003 Oct 1;112(4):939-42.
9. Sparks B, Cooper J, Hayes C, Williams K. Constipation in children with autism spectrum disorder associated with increased emergency department visits and inpatient admissions. *The Journal of pediatrics.* 2018 Nov 1;202:194-8.
10. Fulceri F, Morelli M, Santocchi E, Cena H, Del Bianco T, Narzisi A, Calderoni S, Muratori F. Gastrointestinal symptoms and behavioral problems in preschoolers with Autism Spectrum Disorder. *Digestive and Liver disease.* 2016 Mar 1;48(3):248-54.

**Table 1 – Questionnaire used for cross sectional analysis**

**QUESTIONNAIRE**

**Name of Parent:**

**Name of Child:**

**(optional)**

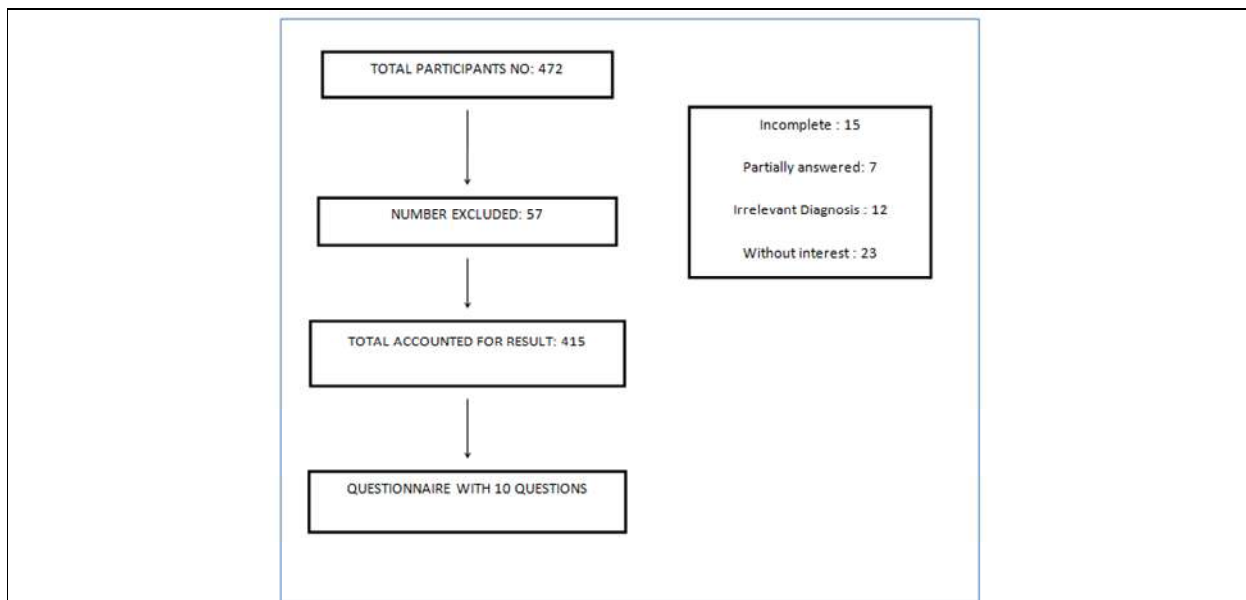
1. Does your child lick objects, floor, wall or chew the dress, collar or toys?  
Yes/No
2. Is your Child a picky eater ( Does he/she shows interest in eating any particular food alone and avoids common foods like rusk , fruits etc)  
Yes/No
3. Does your child chew the food sufficiently or swallows the food quite often unless instructed?  
Chews the food Yes/No/ To certain extent  
Swallows the food Yes/No/Mostly/Sometimes
4. If appreciable chewing is observed does the child chew from front of the teeth or back of teeth.  
Front of teeth/Back of teeth/ did not notice
5. Does the child exhibit unusual repetitive/extreme behavior ( like gagging, overeating) due to or after intake of certain foods.  
Yes/ No
6. Does the child exhibit any of the following
  1. Frequent bloating of stomach
  2. Frequent gas or flatulence
  3. Reflux or heart burn
  4. Soiling
  5. Nausea/vomiting
7. Have you observed constipation in your child?  
Yes/No.  
If yes frequency of constipation
  - a. Twice a week
  - b. Thrice a week
  - c. Almost daily



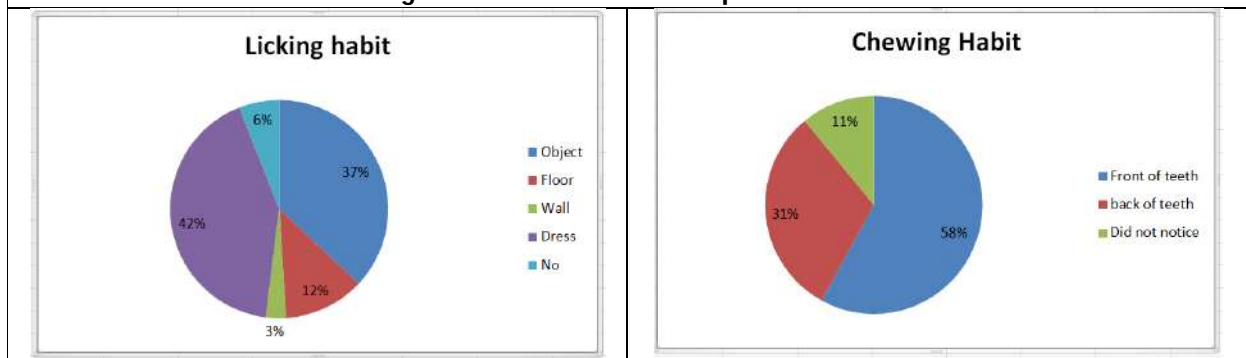


**Sumitha Hemavathy et al.,**

8. Does the child exhibit any of the following before toileting?
  1. Arching of back
  2. Stiffening/squeezing of buttocks
  3. Applying pressure to the abdomen
  4. Tightening/crossing of thighs
  
9. Are you aware that pelvic floor and abdominal exercises help in reducing constipation and improve gastrointestinal mobility?  
Yes/No
  
10. Is the child on any special diet like GFCF diet, Feingold diet, Specific carbohydrate diet or Yeast free diet.  
If yes specify the name \_\_\_\_\_



**Figure 1 – Flow Chart of Sample Selection**



**Figure 2 – Results of Q.1 – Does your child Lick?**

**Figure 3 – Results of Q 4 From which part the child chews?**





**Sumitha Hemavathy et al.,**

<p><b>GI Symptoms</b></p> <ul style="list-style-type: none"> <li>Bloating: 22%</li> <li>Flatulence: 32%</li> <li>Reflux: 12%</li> <li>Soiling: 16%</li> <li>Vomiting: 18%</li> </ul>	<p><b>Frequency of Constipation</b></p> <ul style="list-style-type: none"> <li>Twice a week: 21%</li> <li>Thrice a week: 23%</li> <li>Almost daily: 56%</li> </ul>
<p><b>Figure 4 – Results of Q 6 – Does the child exhibit these?</b></p>	<p><b>Figure 5 –Results of Q 7 – Have you observed constipation in your child?</b></p>
<p><b>Pre Toileting Signs</b></p> <ul style="list-style-type: none"> <li>Arching of Back: 13%</li> <li>Squeezing of buttocks: 36%</li> <li>Pressure on Abdomen: 27%</li> <li>Crossing of Thighs: 24%</li> </ul>	<p><b>Role of Exercise in GI mobility</b></p> <ul style="list-style-type: none"> <li>Yes: 17%</li> <li>No: 83%</li> </ul>
<p><b>Figure 6 – Results of Q 8 – Does the child exhibit any of the following?</b></p>	<p><b>Figure 7 – Results of Q 9 – are you aware of role of pelvic floor and abdominal exercise in reducing constipation?</b></p>





## Phytochemical Screening, Gas Chromatography – Mass Spectrometry Profiling of Methanolic Extract of *Syzygium zeylanicum* Leaves

V.Gomathy<sup>1</sup>, V.Chitra<sup>2</sup>, V. Muruganandan<sup>3</sup> and Praseeda K G<sup>4\*</sup>

<sup>1</sup>Professor, Department of Pharmacology, Vinayaka Mission's College of Pharmacy, Salem, Tamil Nadu, India.

<sup>2</sup>Professor and Head, Department of Pharmacology, SRM College of Pharmacy, Chennai, Tamil Nadu, India.

<sup>3</sup>Professor, Department of Pharmaceutics, Vinayaka Mission's College of Pharmacy, Salem, Tamil Nadu, India.

<sup>4</sup>Research Scholar, Vinayaka mission's Research Foundation, Ariyannor p.o, Salem, Tamil Nadu, India.

Received: 10 Nov 2021

Revised: 15 Dec 2021

Accepted: 11 Jan 2022

### \*Address for Correspondence

**Praseeda K G**

Research Scholar,

Vinayaka mission's Research Foundation,

Ariyannor p.o, Salem, Tamil Nadu, India.

Email: praseedakg@gmail.com



This is an Open Access Journal / article distributed under the terms of the **Creative Commons Attribution License** (CC BY-NC-ND 3.0) which permits unrestricted use, distribution, and reproduction in any medium, provided the original work is properly cited. All rights reserved.

### ABSTRACT

The present study is to investigate the phytochemical composition and GC-MS profiling of methanol extract of *Syzygium zeylanicum* leaves. The methanol extract of the leaves of the plant *S. zeylanicum* shows the presence of medicinally important phytoconstituents such as phenolic compounds, tannins and phytosterols, flavonoid, saponin, glycoside. The methanolic extract contain Phenol (439µg/mg), Tannins (403.73µg/mg), phytosterols (523.38µg/mg), alkaloids (243.62 µg/mg), terpenoids (131.14 µg/mg), glycosides (5190 µg/mg), saponins (227.61 µg/mg) were highly present and other compounds were absent. GC-MS study the showed that prevailing compounds are DL-Norleucine, N-allyloxycarbonyl, decyl ester (MW: 355), Mercaptoacetic acid, bis (trimethylsilyl) (MW: 236, and N-Methyladrenaline, triTMS (MW: 413), respectively were identified out of 5 hits as obtained from NIST mass spectral library. This may help us to identify new promising lead molecules for finding effective medicines with less side effects.

**Keywords:** *Syzygium zeylanicum*, phytochemical screening, accelerated solvent extraction, GC-MS analysis, total phenolic content.



**Gomathy et al.,**

## INTRODUCTION

Traditional medicines generated from plants and their derivatives play an important part in human health-care systems, and researchers are increasingly interested in phytochemical screening and activity profiling of medicinal plants as a potential treatment for a variety of diseases. Plants create secondary metabolites, which are a source of active pharmacological substances that can be easily made into a consumable formulation.

*Syzygium zeylanicum* (L.) DC

Family: Myrtaceae

Synonyms: *Eugenia zeylanica*, *Eugenia spicata*

Vernacular names:

Malayalam: Kattuvazhana, vennjara, poochapazham

Tamil: Vennaval, kaduppennerde

Other: Cat's eye

Flowering season: February, march, April

Kerala's Western Ghats are home to this plant. A medium shrub with lustrous, appealing leaves. The blooms are white and fragrant, and they bloom in bunches. White tiny berries with a single greenish seed and thin flesh are the fruits. In mature specimens, the trunk is reddish brown with papery flaky bark. (Pagoh Johor P, Sultan Haji Ahmad Shah P 2015). Almost every plant element is beneficial in some manner. The plant's edible fruits are thought to be particularly healthy. The leaf extracts have traditionally been used to alleviate pain, headaches, arthritis, and fever. The plant's historic applications indicate that it is an excellent candidate for anti-inflammatory and defensive properties. Leaf decoction has anthelmintic, anti-diabetic, and vermifuge properties, and can be used to treat syphilis. (Anoop M V., Bindu AR 2014). The existence of various therapeutically useful classes of chemicals such as alkaloids, flavonoids, phenolics, glycosides, sterols, terpenoids, saponins, and carbohydrates was discovered after phytochemical analysis of the plant's leaves. Polyphenolics are well-known for their antioxidant properties, and their activities are critical for good health. The presence of important minerals and micronutrients in *Syzygium zeylanicum* fruits has also been established. The antioxidant, nephroprotective, and hepatoprotective activities of the extract can be estimated based on its essential mineral content, free radical scavenging characteristics, and polyphenolic content. (Anoop M V, Bindu AR 2015).

## MATERIALS AND METHODS

### Collection of the plant material

The plant *Syzygium zeylanicum* was collected from Periya road, Wayanad district. The plant was identified and authenticated from Botanical Survey of India, Coimbatore.

### Chemicals and Reagents.

All chemicals and reagents are sourced locally from certified suppliers and are analytical grade.

### Preparation of the extract

The whole extract of the plant in methanol was taken using an accelerated solvent extractor. The extract was then concentrated using a rotary evaporator and stored at 4°C until use.

### Quantitative Phytochemical screening

#### Estimation of phenol

Procedure: The sample was pipetted and the volume in the tube was made up to 3.0 ml of distilled water against the distilled water blank. Folin Ciocalteu reagent (0.5 ml) was added and then 2 ml of 20% sodium bicarbonate solution was added; the tubes were placed in a boiling water bath for exactly one minute. The tubes were cooled and the





**Gomathy et al.,**

absorbance was read at 750 nm in a spectrophotometer against a reagent blank. Standard gallic acid solutions corresponding to concentrations of 20100µg were also treated as above(Kamtekar S et al. 2014).

**Estimation of alkaloid**

**Procedure:** The plant extract (1 mg) was dissolved in 1 ml dimethyl sulfoxide (DMSO), 1 ml 2N HCl added and filtered. This solution was transferred to a separatory funnel, 5 ml of bromocresol green solution and 5 ml of phosphate buffer were added. The mixture was shaken with 1, 2, 3 and 4 ml of chloroform with vigorous stirring and collected in a 10 ml volumetric flask and diluted to volume with chloroform. A set of atropine reference standard solutions (20, 40, 60, 80 and 100 g) was prepared in the same manner as previously described. The absorbance of the test and standard solutions was determined against the reagent blank at 470 nm with a UV/visible spectrophotometer.(Soni V et al. 2018)

**Estimation of tannin**

**Procedure:** The tannin content of the sample was determined by the Folin Ciocalteu method. The colorimetric estimate of tannins is based on the measurement of the blue color formed by the reduction of phosphor tungsten molybdic acid by tanning compounds in an alkaline medium. 1 ml of extract and standard tannic acid solution (20-100 µg) was made up to 7.5 ml with distilled water. Then 0.5 ml of Folin Ciocalteu reagent and 35% of 1 ml of sodium carbonate solution were added. The volume was made up to 10 ml with distilled water and the absorbance was measured at 700 nm(Chandran KC, Kavitha Chandran CC 2016).

**Estimation of flavonoid**

**Procedure:** The total flavonoid content was measured by the aluminum chloride colorimetric test. The reaction mixture consists of 1 mg/ml extract and 4 ml distilled water is placed in a 10 ml volumetric flask. In the flask, 0.30 ml of 5% sodium nitrite was treated and after 5 minutes, 0.3 ml of 10% aluminum chloride was mixed. After 5 minutes, 2 ml of 1 M sodium hydroxide was treated and diluted to 10 ml with distilled water. A set of quercetin reference standard solutions (20, 40, 60, 80 and 100 mg) was prepared in the same manner as previously described. The absorbance of the test and standard solutions was determined against the reagent blank at 510 nm with a UV/visible spectrophotometer. Total flavonoid content was expressed in mcg/mg extract(LeeWei H, Ismail IS 2012).

**Estimation of terpenoid**

**Procedure:** Then, 100 µL of sample was mixed with vanillin-glacial acetic acid solution (150 µL, 5% w/v) and perchloric acid solution (500 µL). The sample solutions were heated for 45 min at 60°C and then cooled in an ice-water bath to the ambient temperature. After the addition of glacial acetic acid (2.25 mL), absorbance of each sample solution was measured at 548 nm, using a UV-visible-light spectrophotometer. Linalool (20-100 µg in methanol) was used as a standard(Ghorai N et al 2012).

**Estimation of glycosides**

**Principle:** Cardiac glycosides develop an orange-red complex with Baljet's reagent (picric acid in an alkaline medium). The intensity (absorption) of the color produced is proportional to the glycoside concentration. Cardiac glycosides were quantified according to Solichet al. by some modifications.

**Reagents**

- i. **Standard digitoxin:** 0.02% digitoxin is prepared in chloroform: methanol (1:1).
- ii. **Baljet's reagent:** Freshly prepared 95ml 1% picric acid + 5ml 10% NaOH are mixed immediately before use and filtered through a sintered glass funnel.
- iii. **Procedure:** 1ml of the extract and 1ml of Baljet's reagent are taken and allowed to stand for one hour. Then dilute the solution with 2ml distilled water and mix. Read the intensity of the colour obtained against blank at 495nm using a spectrophotometer. Standard graph can be prepared using varying concentration of standard digitoxin (2-14µg)(Tofighi Z et al 2016)



**Gomathy et al.,****Estimation of steroids (zak's method, 1954)****Reagents:**

- i. Stock ferric chloride - 840 mg of pure dry ferric chloride was weighed and dissolved in 100 ml glacial acetic acid.
- ii. Ferric chloride diluting reagent- 8.5 ml of stock ferric chloride was diluted to 100 ml with pure glacial acetic acid.
- iii. Concentrated Sulphuric acid.
- iv. Cholesterol Solution.
- v. Stock Standard – 100 mg of cholesterol was dissolved in 100 ml of glacial acetic acid.
- vi. Working standard – 10 ml of stock was dissolved in 0.85 ml of stock ferric chloride reagent and made up to 100 ml with glacial acetic acid. The concentration of working standard is 100µg / ml.

**Procedure**

1 mg/ml sample extract is taken and a set of standards (10-100 g) is taken and made up to 5 ml with a ferric chloride diluent reagent. Simultaneously, a blank was prepared by taking 5.0 ml of diluent reagent. Then add 4.0 ml of concentrated sulfuric acid to each tube. After 30 minutes of incubation, the intensity of the developed color was read at 540 nm. (Kritchevsky D, Tepper SA 1961)

**Estimation of saponins**

**Procedure:** The vanillin-sulphuric acid assay for determining the total saponin content of plant materials is usually done by incubating 1mg/ml of plant sample extracts, standards or reagent blank with 0.25 mL of 0.8% (w/v) vanillin in ethanol and 2.5 mL of 72% (v/v) sulphuric acid in water for 15 min at 60°C in a shaking water bath, with the standard as diosgenin and the reagent blank made up with the solvent used for extracting the plant samples (extraction solvent). After cooling in water at the ambient temperature for 5 min, the absorbance of the standards and extracts are measured at 544 nm using a UV-VIS spectrophotometer (Aparna Rama Laxmi Devi M et al 2015).

**Gas chromatography-mass spectrometry (GC-MS) (Gayathri D, Devaraja G. 2013, Devakumar J et al 2017)**

**Methodology:** The plant based phytochemical identification of methanolic extracts of *Syzygium zeylanicum* was executed on a Gas chromatography-mass spectrometry (GC-MS) technique and it was performed at the Manoothi Veterinary College, Thrissur, Kerala. The chemical-based constituents of the extract were carried by utilizing a Thermo Scientific TSQ 8000 GC-MS instruments. Thermo scientific instrument that comprises of explicit capillary interfacial layer forming a fusion with capillary column of silica Trace GOLD 5MS (30 m X 0.25 mm, 0.25 µm). The experimental conditions of GC-MS technique are as follows.

Capillary silica column Trace GOLD 5MS,

1. Carrier gas – Helium at consistent rate of 1 mL/min in a pulsed split less mode.
2. Delay of solvent – 2 to 4 min
3. Size of injection - 1.0 µL
4. Running time for GC-MS – 25 min
5. Operated in the form of electron impact ionization mode with an ionization energy of 75 eV and scanning was carried from m/z 50-700
6. The temperature for this program started at 40°C which was then increased to 250°C at a rate of 10°C per min and with a 10 minutes hold at 350°C. The setting limitation of injector, ion source and detector temperatures are at 250, 230 and 300°C respectively.
7. The observed peaks which are segregated in a GC-MS were determined by National Institute of Standards and Technology (NIST) mass spectra databases.
8. The constituents exist in all the three-plant extract was recognized based on the assessment of their comparative retention time and mass spectral.

The component's name, their molecular weight and its structure were also determined.





Gomathy et al.,

## RESULTS AND DISCUSSIONS

The phytoconstituents of the total methanol extract of the plant *Syzygium zeylanicum* was done quantitatively, and showed the presence of phenolic compounds, terpenoids, flavonoids, alkaloids and glycosides

### GC-MS – *Syzygium zeylanicum*

The chromatogram for the extract of *Syzygium zeylanicum* is exemplified in figure 1. It was found to be observed that, from the retention time between 6.65 to 22.99 minutes, there were nearly 8 smaller peaks were noticed, 1,3,5-trimethyl-2-octadecyl (MW: 378), Urea, heptyl (MW: 158) and Ethanone, 1(4-cycloocten-1-yl) (MW: 152), respectively was observed.

Ultimately, at the end of the period of 15.33, 15.98, 19.78, 22.30, 22.62, 23.36, 24.30 minutes, minor peaks were observed in the presence of compounds namely, (3-Aminopropyl) dibutylborane (MW: 183), 4(1H) Quinolinone, 1(4-chlorophenyl) 2,3-diphenyl (MW: 407), 4-sec-butylacridone (MW: 251), 6-methoxy-2-(naphthylmethylene) 3(2H)benzofuranone (MW: 302), 3-aminopyrazole (MW: 83), 4,5-octanediol (MW: 146), 4'-amino-6-methoxyaurone (MW: 267) respectively were identified. Peak area and retention time were used for the identification of the compounds. The compound Amino propyl dibutylborane (C<sub>11</sub>H<sub>26</sub>BN) obtained from Saudi hot spring, four thermophilic bacterial strains isolates exhibiting antimicrobial activity against all tested human pathogens, it also showed anti-inflammatory as well as ROS scavenging activity. Also TriButylBorane exerts anti-inflammatory activity and is extremely reactive with the oxygen O-O biradical and ROO radical. (Alrumman SA et al 2019, Kawata A, et al 2018). 4(1H)Quinolinone, 1(4-chlorophenyl)2,3-diphenyl, a compound with alkaloidal properties, which is a (1H)-quinolinone derivatives as anti-histamine agents and having neuroleptic activity. 4(1H)-quinolone-3-carboxylic acid derivatives are widely used as antibacterial agents (Banno K et al, Ahmed A, Daneshtalab M 2011). Sec-butyl, acridone, acridones are biologically active fused heterocyclic rings with various pharmacological activities like antimicrobial, anticancer, antiviral, antimalarial, and anti-inflammatory activities (Vishwanadham Yerragunta, Gensicka-Kowalewska M et al 2017). 6-methoxy-2-(naphthylmethylene) 3(2H)benzofuranone, alkoxy benzofuranone derivative a potent anticholinesterase agent (Alzheimer's) activity (Nadri H et al 2013). 3-aminopyrazole (Iglesias AL et al 2019), 4,5-octane diol (Okukawa M et al 2019), 4-amino, 6-hydroxy aurone (Hassan GS et al 2018) (a flavone compound) possess anticancer, antioxidant, antibacterial, anti-tyrosinase, antidiabetic and anti-obesity and many other pharmacological activities. The 2D chemical structure of some of the identified compounds were exemplified in figure 2 and also table 2 clearly depicts molecular weight and percentage of top peak area of the identified compounds from the extract of *Syzygium Zeylanicum*.

## CONCLUSION

The chemical analysis of *Syzygium zeylanicum* leaves extract has been evaluated first time. The results of GC-MS analysis and Quantitative phytochemical screening revealed that the leaves contained numerous bioactive phytoconstituents belonging to various classes such as Glycosides, alkaloids, phenolics, flavonoids, sterols, tannins, saponins and terpenoids. Generally, these classes of chemical compounds exhibit biological activities such as antioxidant, antimicrobial, anti-cancerous, antirheumatic, antimalarial etc. The presence of various classes of chemical compounds confirms that the plant hold medicinal value and further plan of study includes isolation and purification of chemical compounds for their bioactivity studies which will give hopeful results.

## REFERENCES

1. Ahmed A, Daneshtalab M. Nonclassical biological activities of quinolone derivatives [Internet]. Vol. 15, Journal of Pharmacy and Pharmaceutical Sciences. Canadian Society for Pharmaceutical Sciences; 2011 [cited 2021 Jan 23]. p. 52–72. Available from: <https://pubmed.ncbi.nlm.nih.gov/22365088/>



**Gomathy et al.,**

2. Alrumman SA, Mostafa YS, Al-Qahtani STS, Sahlabji T, Taha TH. Antimicrobial Activity and GC-MS Analysis of Bioactive Constituents of Thermophilic Bacteria Isolated from Saudi Hot Springs. Arab J Sci Eng [Internet]. 2019 Jan 24 [cited 2021 Jan 23];44(1):75–85. Available from: <https://link.springer.com/article/10.1007/s13369-018-3597-0>
3. Anoop M V, Bindu AR. In-vitro Anti-inflammatory Activity Studies on Syzygium zeylanicum (L.) DC Leaves. Int J Pharma Res Rev. 2015;4(8):18.
4. Anoop M V., Bindu AR. Pharmacognostic and physico-chemical studies on leaves of Syzygium zeylanicum (L.) DC. Int J Pharmacogn Phytochem Res. 2014;6(4):685–9.
5. Aparna Rama Laxmi Devi M, Yaso Deepika M, Nagaraju B, Prasad K. Evaluation of nephroprotective activity of ethanolic extract of annona reticulata in gentamicin and cisplatin induced nephrotoxicity in rats. J Pharm Sci Res. 2015;8(9):995–1007.
6. Banno K, Fujioka T, Kikuchi T, Oshiro Y, Hiyama T, Nakagawa K. Studies on 2(1H)-Quinolinone Derivatives as Neuroleptic Agents.I. Synthesis and Biological Activities of(4-Pheny1-1-piperaziny1)-propoxy-2(1H)-quinolinone Derivatives.
7. Chandran KC, Kavitha Chandran CC. Quantitative estimation of total phenolic, flavonoids, tannin and chlorophyll content of leaves of Strobilanthes Kunthiana (Neelakurinji). Vol. 4, - 282 - Journal of Medicinal Plants Studies. 2016.
8. Devakumar J, Keerthana V, Sudha SS. Identification of bioactive compounds by gas chromatography-mass spectrometry analysis of Syzygium jambos (L.) collected from Western Ghats region Coimbatore, Tamil Nadu. Asian J Pharm Clin Res [Internet]. 2017 Jan 1 [cited 2021 Jan 21];10(1):364–9. Available from: <http://dx.doi.org/10.22159/ajpcr.2017.v10i1.15508>
9. Gayathri D, Devaraja G. INDO AMERICAN JOURNAL OF PHARMACEUTICAL RESEARCH Antibacterial potential and phytochemical analysis of Flacourtia indica (Burm.f.) Merr. root extract against human pathogens. Indo Am J Pharm Res [Internet]. 2013 [cited 2021 Jan 21];2013(5):3. Available from: [www.iajpr.comhttp://www.iajpr.com/index.php/en/www.iajpr.com](http://www.iajpr.comhttp://www.iajpr.com/index.php/en/www.iajpr.com)
10. Gensicka-Kowalewska M, Cholewiński G, Dzierzbicka K. Recent developments in the synthesis and biological activity of acridine/acridone analogues [Internet]. Vol. 7, RSC Advances. Royal Society of Chemistry; 2017 [cited 2021 Jan 23]. p. 15776–804. Available from: <https://pubs.rsc.org/en/content/articlehtml/2017/ra/c7ra01026e>
11. Ghorai N, Ghorai N, Chakraborty S, Guichait S, Saha SK, Biswas S. Estimation of total Terpenoids concentration in plant tissues using a monoterpene, Linalool as standard reagent. Protoc Exch [Internet]. 2012 Nov 27 [cited 2021 Jan 20]; Available from: <http://www.nature.com/protocolexchange/protocols/2529>
12. Hassan GS, Georgey HH, George RF, Mohamed ER. Aurones and furoaurones: Biological activities and synthesis. Bull Fac Pharmacy, Cairo Univ. 2018 Dec 1;56(2):121–7.
13. Iglesias AL, Miranda-Soto V, Pompa-Monroy DA, Martinez-Ortiz JG, Diaz-Trujillo GC, Villarreal-Gomez I. J. Biological Activity of New Schiff Base Compounds Derived from Substituted 3-Aminopyrazoles, the Role of Pyrazole on Bioactivity. Indian J Pharm Sci [Internet]. 2019 Mar 27 [cited 2021 Jan 23];81(2):333–43. Available from: [www.ijpsonline.com](http://www.ijpsonline.com)
14. Kamtekar S, Keer V, Patil V. Estimation of phenolic content, flavonoid content, antioxidant and alpha amylase inhibitory activity of marketed polyherbal formulation. J Appl Pharm Sci. 2014;4(9):61–5.
15. Kawata A, Murakami Y, Suzuki S, Fujisawa S. Anti-inflammatory activity of  $\beta$ -carotene, lycopene and tri-n-butylborane, a scavenger of reactive oxygen species. In Vivo (Brooklyn) [Internet]. 2018 [cited 2021 Jan 23];32(2):255–64. Available from: <https://pubmed.ncbi.nlm.nih.gov/29475907/>
16. Kritchevsky D, Tepper SA. The Free and Ester Sterol Content of Various Foodstuffs. J Nutr [Internet]. 1961 Aug 1 [cited 2021 Jan 20];74(4):441–4. Available from: <https://academic.oup.com/jn/article/74/4/441/4777233>
17. LeeWei H, Ismail IS. Antioxidant activity, total phenolics and total flavonoids of Syzygium polyanthum (Wight) Walp leaves. undefined. 2012;
18. Nadri H, Pirali-Hamedani M, Moradi A, Sakhteman A, Vahidi A, Sheibani V, et al. 5,6-Dimethoxybenzofuran-3-one derivatives: A novel series of dual Acetylcholinesterase/Butyrylcholinesterase inhibitors bearing benzyl pyridinium moiety. DARU, J Pharm Sci [Internet]. 2013 [cited 2021 Jan 23];21(1):15. Available from: [/pmc/articles/PMC3599263/?report=abstract](http://pmc/articles/PMC3599263/?report=abstract)
19. Okukawa M, Watanabe T, Miura M, Konno H, Yano S, Nonomura Y. Antibacterial activity of 1,2-alkanediol





## Gomathy et al.,

- against staphylococcus aureus and staphylococcus epidermidis. Vol. 68, Journal of Oleo Science. Japan Oil Chemists Society; 2019. p. 759–63.
20. Pagoh Johor P, Sultan Haji Ahmad Shah P. R B A S Phytochemical Screening, Total Phenolic Content and Antioxidant Activity of *Syzygium zeylanicum* Leaves AZIZAH MAHMOOD FAZURA MINHAD HELEN TEH AZHARY YAHYA [Internet]. International Review of Basic and Applied Sciences. 2015 [cited 2021 Jan 20]. Available from: [www.irbas.academyirmbr.com](http://www.irbas.academyirmbr.com)
21. Soni V, Jha AK, Dwivedi J, Soni P. Qualitative and Quantitative Determination of Phytoconstituents in Some Antifertility Herbs. Indian J Pharm Sci [Internet]. 2018 Feb 28 [cited 2021 Jan 21];80(01):79–84. Available from: [www.ijpsonline.com](http://www.ijpsonline.com)
22. Tofighi Z, Ghazi N, Hadjiakhoondi A, Yassa N. Determination of cardiac glycosides and total phenols in different generations of *Securigera securidaca* suspension culture [Internet]. Vol. 3, Research Journal of Pharmacognosy (RJP). 2016 [cited 2021 Jan 20]. Available from: <http://rjpharmacognosy.ir>
23. Vishwanadham Yerragunta\*. (PDF) A Review on Acridone Derivatives and its Importance [Internet]. [cited 2021 Jan 23]. Available from: [https://www.researchgate.net/publication/318682085\\_A\\_Review\\_on\\_Acridone\\_Derivatives\\_and\\_its\\_Importance](https://www.researchgate.net/publication/318682085_A_Review_on_Acridone_Derivatives_and_its_Importance)

Table 1 Quantitative estimation of phytoconstituents in *Syzygium zeylanicum* methanol extract

Total phenolic content	Concentration of phenol in Gallic acid equivalent $\mu\text{g}/\text{mg}$ of extract	439.06
Alkaloids	Concentration of alkaloid in Atropine equivalent $\mu\text{g}/\text{mg}$ of extract	243.62
Tannins	Concentration of tannin in tannic acid equivalent $\mu\text{g}/\text{mg}$ of extract	403.73
Flavonoids	Concentration of flavonoid in quercetin equivalent $\mu\text{g}/\text{mg}$ of extract	306.25
Terpenoids	Concentration of terpenoid in Linalool equivalent $\mu\text{g}/\text{mg}$ of extract	131.14
Glycosides	Concentration of glycosides in Digitoxin equivalent $\mu\text{g}/\text{mg}$ of sample	5190.4
Steroids	Concentration of steroid in cholesterol equivalent $\mu\text{g}/\text{mg}$ of extra	523.38
Saponins	Concentration of saponins in Diosgenin equivalent $\mu\text{g}/\text{mg}$ of sample	227.61

Table 2. Phyto-compounds present in Methanolic extract of *Syzygium zeylanicum* using GC-MS Profiling

Sr. No.	RT (min)	Name of compound	Probability	Molecular formula	Molecular weight	Area %
1	4.48	2-Propenoic acid, chloromethyl ester	77.90	$\text{C}_4\text{H}_5\text{ClO}_2$	120	0.10
2	5.64	2[1,2Dihydroxyethyl]9 [ribofuranosyl] hypoxanthine	67.80	Not available (formula is available only for hypoxanthine)	328	0.05
3	5.66	1Bromo7(tetrahydro2pyranyloxy) heptane	59.42	$\text{C}_{12}\text{H}_{23}\text{BrO}_2$	278	0.22
4	5.90	2HPyran, tetrahydro3methyl	52.16	$\text{C}_6\text{H}_{12}\text{O}$	100	0.23
5	7.69	3(2'Chloro4'(trimethylsilyloxy)	75.36	Not available	358	0.12





## Gomathy et al.,

		phenyl)2methyl4(3H)quinazolinone		(formula is available only for 2-methyl-4(3H)-quinazolinones)		
6	8.07	Cyclohexane, 1,4dimethyl2octadecyl	44.65	C <sub>26</sub> H <sub>52</sub>	364	0.27
7	13.27	1,2,4,5Tetrazine,3,6diethyl	44.50	C <sub>6</sub> H <sub>10</sub> N <sub>4</sub>	138	0.26
8	13.59	Alanine	44.25	C <sub>3</sub> H <sub>7</sub> NO <sub>2</sub>	516	0.04
9	13.98	Cyclohexane, 1,4dimethyl2octadecyl	38.09	C <sub>26</sub> H <sub>52</sub>	364	0.10
10	15.33	(3Aminopropyl) dibutylborane	58.79	C <sub>11</sub> H <sub>26</sub> BN	183	0.37
11	15.14	Dimethylmalonic acid, di(2fluoro3trifluoromethylphenyl)ester	57.24	C <sub>19</sub> H <sub>12</sub> F <sub>8</sub> O <sub>4</sub>	456	0.08
12	14.61	Bismuthine, tripropyl	73.89	C <sub>9</sub> H <sub>21</sub> Bi	338	0.09
13	15.58	Urea, heptyl	43.10	C <sub>8</sub> H <sub>18</sub> N <sub>2</sub> O	158	1.16
14	15.98	4(1H)Quinolinone,1(4chlorophenyl)2,3 diphenyl	62.74	C <sub>20</sub> H <sub>16</sub> N <sub>4</sub> O <sub>3</sub>	407	0.05
15	16.11	Ethane, 1chloro2nitro	49.84	C <sub>2</sub> H <sub>4</sub> CINO <sub>2</sub>	109	0.10
16	17.17	Benzene, [(2,2dimethoxyethyl) sulfonyl]	43.16	C <sub>10</sub> H <sub>14</sub> O <sub>4</sub> S	230	0.13
17	18.31	Methyl galactoside, 4,6dimercapto4,6dideoxy 2,3,4,6 O,O,S, Stetrabenzyl	47.51	-	586	0.05
18	19.50	ë Amino levulinic acid triTMS	43.46	C <sub>14</sub> H <sub>33</sub> NO <sub>3</sub> Si <sub>3</sub>	347	0.06
19	19.60	2,3Butanediol, 2,3dimethyl	40.34	C <sub>6</sub> H <sub>14</sub> O <sub>2</sub>	118	0.57
20	19.78	4 Secbutylacridone	41.62	C <sub>17</sub> H <sub>17</sub> NO	251	0.08
21	19.97	2Propenoicacid, 3(6,6dimethylbicyclo [3.1.1]hept2en2yl),methyl ester,(E)	41.57	-	206	0.04
22	20.3	Acetamide, 2(1Hindol3yl) 2oxo N (4,5,6,7tetrahydro benzothiazol2yl)	66.47	Not available (structure available only for acetamide)	325	0.12
23	20.43	Mercaptoacetic acid, bis(trimethylsilyl)	66.47	C <sub>8</sub> H <sub>20</sub> O <sub>2</sub> SSi <sub>2</sub>	236	1.82
24	21.42	Phosphoric acid, diethyl pentyl ester	44.41	C <sub>9</sub> H <sub>21</sub> O <sub>4</sub> P	224	0.10
25	21.87	2,4(1H,5H) Imidazoledione, dihydro 5[2fluoro4,5dimethoxybenzyl] 5methyl	47.92	-	282	0.08
26	22.22	1,3Dibenzyl2pyridin4ylhexahydropyridine	49.47	C <sub>23</sub> H <sub>25</sub> N <sub>3</sub>	343	0.11
27	22.25	1(2,2,2Trichloro1cinnamamidoethyl)3(3 hydroxyphenyl)2thiourea	34.80	-	443	0.20
28	22.13	MethaneD2, Dichloro	38.25	CD <sub>2</sub> Cl <sub>2</sub>	86	0.05
29	22.30	6Methoxy2(2naphthylmethylene) 3(2H)benzofuranone	72.13	-	302	0.11
30	22.62	3Aminopyrazole	46.74	C <sub>3</sub> H <sub>5</sub> N <sub>3</sub>	83	0.07
31	22.65	N-Ethylformamide	40.37	C <sub>3</sub> H <sub>7</sub> NO	72	0.07
32	22.89	10HPhenoxaphosphine,10hydroxy2,4,6, 8tetramethyl,10oxide	69.36	-	288	0.07
33	22.99	N-Methyladrenaline,triTMS	44.44	C <sub>19</sub> H <sub>39</sub> NO <sub>3</sub> Si <sub>3</sub>	413	1.25





Gomathy et al.,

34	23.09	1Propanone,1(1cyclohexenyl)	51.97	C <sub>9</sub> H <sub>14</sub> O	138	0.09
35	23.36	4,5-octanediol	54.16	C <sub>8</sub> H <sub>18</sub> O <sub>2</sub>	146	0.09
36	24.30	4'Amino6methoxyaurone	39.08	C <sub>16</sub> H <sub>13</sub> NO <sub>3</sub>	267	0.13
37	24.65	Ethanol, 2(cyclohexyl) (4methoxyphenylsulfonyl) amino	64.05	-	313	0.55

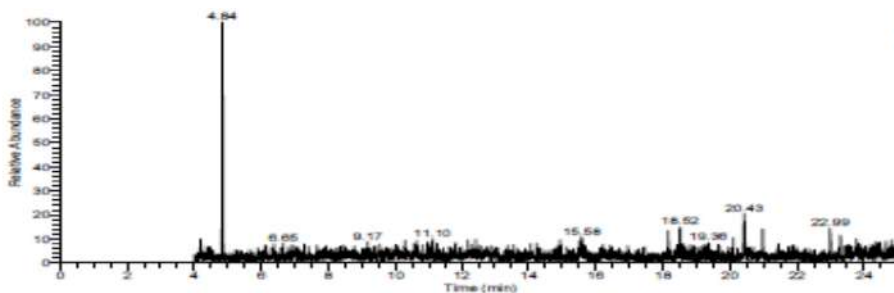


Figure 1. Chromatogram attained from the GC-MS with the methanol extract of leaves of *Syzygium zeylanicum*.

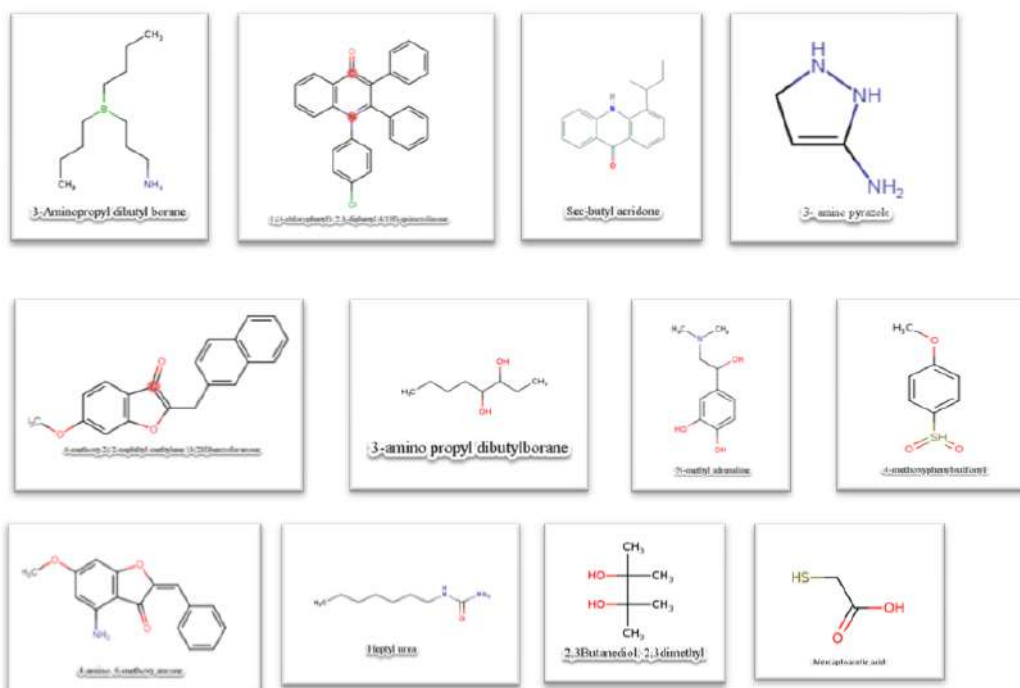


Figure 2. The 2D chemical structures of some of the identified compounds





## Study of Antioxidant Potential and Quantification of Total Phenolic and Flavonoid Content in the Leaves of *Vitex negundo* by using Various *In vitro* Models

T.Vinciya<sup>1\*</sup> and S.Rani<sup>2</sup>

<sup>1</sup>Research Scholar, Department of Pharmacy, Annamalai University, Annamalai Nagar, Chidambaram - 608002, Tamil Nadu, India.

<sup>2</sup>Associate Professor, Department of Pharmacy, Annamalai University, Annamalai Nagar, Chidambaram - 608002, Tamil Nadu, India.

Received: 29 Nov 2021

Revised: 30 Dec 2021

Accepted: 13 Jan 2022

### \*Address for Correspondence

#### T.Vinciya

Research Scholar,  
Department of Pharmacy,  
Annamalai University, Annamalai Nagar,  
Chidambaram - 608002, Tamil Nadu, India.  
Email: veenusvinciya1995@gmail.com



This is an Open Access Journal / article distributed under the terms of the **Creative Commons Attribution License** (CC BY-NC-ND 3.0) which permits unrestricted use, distribution, and reproduction in any medium, provided the original work is properly cited. All rights reserved.

### ABSTRACT

The aromatic shrub *Vitex negundo* Linn. (VN) belongs to the Lamiaceae family and is found throughout India. It is used as a first-line treatment for pain, inflammation, and other disorders in the Ayurvedic medical system. Many polyphenolic compounds, terpenoids, glycosidic iridoids, and alkaloids are found in it. The antioxidant efficacy of *Vitex negundo* was examined using several in vitro models since polyphenolic components have a strong antioxidant potential. As a result, the current study focuses on the antioxidant capacity as well as the determination of total phenolic and flavonoid content. Antioxidant systems play a critical role in the prevention and treatment of many illnesses. Phenolic and flavonoid content are present in leaves of *Vitex negundo*. The successive solvent extracts such as Petroleum Ether extract of *Vitex negundo* (PEEVN), Chloroform extract of *Vitex negundo* (CEVN), Ethyl Acetate extract of *Vitex negundo* (EAEVN), Ethanolic extract of *Vitex negundo* (EEVN) and Aqueous extract of *Vitex negundo* (AEVN) are used for the study. Our results revealed that ethanolic extract of *Vitex negundo* (EEVN) shows potential antioxidant activity and quantitative tests confirms the presence of total phenolic content 77.82 mg Gallic acid Equivalents / g plant extract and total flavonoid content was found to be 30.6 mg Quercetin Equivalents / g plant extract of EEVN. This research work is useful to animal study on leaf extract of *Vitex negundo*, Isolation of active principles and detection of exact mechanism.

**Key words:** *Vitex negundo*, Total phenols, Total flavonoids, Antioxidant activity, Traditional medicine





**Vinciya and Rani****INTRODUCTION**

Plants and plant-derived products contain a wide range of phytochemicals, such as alkaloids, flavonoids, glycosides which are thought to have medicinal properties. Many of the herbals were reported as medicinal plants. In traditional medicine many of the countries used the herbal as therapeutic agents. Nowadays knowing the exact reason for using medicinal plants is important in research work. . The phenolic and flavonoid contents have potent antioxidant properties, thereby playing an important role in treatment of many diseases. *Vitex negundo* Linn., also known as 'Nirgundi/ Sindhvar,' is a major medicinal plant used in traditional and folk medicine for a variety of health problems, some of which have been empirically confirmed. It is extensively grown as a hedge plant along the roadways. *Vitex negundo* Linn. is a tiny tree that grows into a woody, scented shrub. It has tri or penta foliate leaves on quadrangular branches and produces bluish-purple coloured flowers in branched tomentose cymes. In most of India, Bangladesh, and Southeast Asia, *Vitex negundo* is utilised as a folk remedy. For therapeutic purposes, the leaves are the most effective. *Vitex negundo* has traditionally been used to treat inflammation, eye illness, toothache, ulcers, fever, asthma, headache, digestion problems, sinuses, bronchitis, antibacterial, antipyretic, antihistaminic, analgesic, insecticidal, antidote for snake bite, etc. The leaves of these plants have been shown to have mosquito repellent effects as well . The plant is also found to have anticancer, rheumatoid arthritis healing and hepato protective potentials. The leaves are used for treatment of inflammation, skin-ulcers, gonorrhoea, and bronchitis. They are also used as tonics, vermifuge to treat catarrhal fever. Oral administration of the leaves claims to have antihyperglycemic, antibacterial, antipyretic, antihistaminic agents, and implantation activity. Some of the researchers have reported the antioxidant property, phytochemical screening, analgesic activity, and anti-inflammatory. But still there are no reports/studies on the leaves of this plant material. Therefore current research is focused on the study of antioxidants and quantification of total phenolic and flavonoid content in leaves of *Vitex negundo*. And this research paper will be very helpful to the future researchers to study the leaves of *Vitex negundo*.

**MATERIALS AND METHODS****Plant collection and authentication**

The fresh leaves of the plant *Vitex negundo* are collected from Nagercoil, Kanyakumari District, Tamil Nadu, India. month of March 2021 and authenticated by Dr. N. Srinivasan, Department of Pharmacy, Annamalai University, Annamalai Nagar, Chidambaram-608002, Tamilnadu, India.  
Voucher specimen No: PCOL/2021/003

**Preparation of plant material**

The collected leaves were cleaned, washed with distilled water, dried under sun shade in a dark room, and powdered by using a mechanical mixer. After size reduction leaves were sieved under sieve No. 40 and sieve No. 60, stored in an airtight container at room temperature .

**Extraction of the plant material**

200 g of finely powdered leaf powder was extracted with soxhlet using different solvents (nonpolar to polar solvents) successively with Petroleum ether, Chloroform, Ethyl acetate and Ethanol. Following extraction, the extracts were distilled individually and dried at room temperature until they became a viscous solid mass. For further examination, the resulting crude extracts were weighed and kept at 40 °C.

**AQUEOUS EXTRACT**

The finely powdered leaf powder was extracted by cold maceration using water for 15 days. The extract was concentrated by surface evaporation followed by vacuum drying. Dry powder was weighed and stored in air-tight containers for further studies.





### Vinciya and Rani

#### **In vitro antioxidant studies:**

##### **DPPH radical scavenging assay**

The extracts' ability to scavenge free radicals was determined using the DPPH radical scavenging assay. The ability of plant extractives to donate hydrogen atoms was tested by decolorizing a methanol solution of 2,2-diphenyl-1-picrylhydrazyl (DPPH). In methanol solution, DPPH creates a violet/purple colour, which fades to shades of yellow in the presence of antioxidants. 1 ml of 0.135 mM DPPH in methanol was combined with 1 ml of various extracts (0.02–0.1 mg concentration in corresponding solvents). The mixture was incubated at room temperature for 30 minutes in the dark. The spectrophotometer was used to detect absorbance at 517 nm after the incubation time. The standard was ascorbic acid. The radical scavenging activity was calculated by,

$$\text{DPPH radical scavenging activity (\%)} = \frac{(\text{Abs control} - \text{Abs sample})}{(\text{Abs control})} \times 100$$

Where, Abs (control): Absorbance of the control and Abs (sample): Absorbance of the extracts/standard.

##### **Determination of Nitric Oxide Scavenging Assay:**

The activity was determined using Sreejayan and Rao's modified technique. 1 ml sodium nitroprusside (SNP) solution (5mM) was added to 4ml of the extract at various concentrations and incubated for 2 hours at 27°C. A portion of the incubation solution (2 mL) was withdrawn and diluted with 1.2 mL Griess reagent (1 percent Sulfanilamide in 5 percent H<sub>3</sub>PO<sub>4</sub> and 0.1 percent naphthylethylene diamine dihydrochloride). The chromophore's absorbance was measured at 550 nm and compared to a standard, Ascorbic Acid.

$$\text{Nitric oxide scavenging activity (\%)} = \frac{(\text{Abs control} - \text{Abs sample})}{(\text{Abs control})} \times 100$$

Where, Abs (control): Absorbance of the control and Abs (sample): Absorbance of the extracts/standard.

##### **Hydrogen peroxide scavenging assay:**

The ability of the extract to scavenge hydrogen peroxide (H<sub>2</sub>O<sub>2</sub>) was determined according to the method of Ruch et al. Aliquot of 0.1 mL of extracts (25–400 µg/mL) was transferred into the eppendorf tubes and their volume was made up to 0.4 mL with 50 mM phosphate buffer (pH 7.4) followed by the addition of 0.6 mL of H<sub>2</sub>O<sub>2</sub> solution (2 mM). The reaction mixture was vortexed and after 10 min of reaction time, its absorbance was measured at 230 nm. Ascorbic acid was used as the positive control. The ability of the extracts to scavenge the H<sub>2</sub>O<sub>2</sub> was calculated using the following equation:

$$\text{H}_2\text{O}_2 \text{ scavenging activity percentage (\%)} = \frac{(\text{Abs control} - \text{Abs sample})}{(\text{Abs control})} \times 100$$

Where, Abs (control): Absorbance of the control and Abs (sample): Absorbance of the extracts/standard

#### **DETERMINATION OF PHYTOCONSTITUENTS OF EXTRACTS**

##### **Determination of total flavonoid content**

###### **Preparation of standard**

Standard solution was prepared by adding 10 mg of accurately weighed Quercetin in 10 ml of distilled water.

###### **Preparation of sample**

10 mg of the accurately weighed Petroleum Ether extract of *Vitex negundo* (PEEVN), Chloroform extract of *Vitex negundo* (CEVN), Ethyl Acetate extract of *Vitex negundo* (EAEVN), Ethanolic extract of *Vitex negundo* (EEVN) and





### Vinciya and Rani

Aqueous extract of *Vitex negundo* (AEVN) extracts were separately dissolved in 10 ml water and used for the estimation.

#### Procedure

The total flavonoid content of the Petroleum Ether extract of *Vitex negundo* (PEEVN), Chloroform extract of *Vitex negundo* (CEVN), Ethyl Acetate extract of *Vitex negundo* (EAEVN), Ethanolic extract of *Vitex negundo* (EEVN) and Aqueous extract of *Vitex negundo* (AEVN) was determined by using aluminium chloride colorimetric method. To produce the solution up to 2 ml, an aliquot of 1 ml of extract (1 mg/ml) or standard solutions of Quercetin methanol were added separately. 0.1 mL potassium acetate and 2.8 mL distilled water were added to the resultant combination. Shake thoroughly before incubating for 30 minutes at room temperature. The absorbance was measured at 415 nm against a blank solution, which consisted of 2 mL ethanol, 0.1 mL potassium acetate, 2.8 mL distilled water, and 0.1 mL aluminium chloride. From the standard quercetin calibration curve, the total flavonoid content was calculated. In milligrammes of Quercetin equivalents (QE) per gramme of extract, it was calculated.

#### Determination of total phenolic content:

##### Preparation of standard

Standard solution was prepared by adding 10mg of accurately weighed Gallic Acid in 10 ml of Distilled water.

##### Preparation of sample

10mg of the accurately weighed Petroleum Ether extract of *Vitex negundo* (PEEVN), Chloroform extract of *Vitex negundo* (CEVN), Ethyl Acetate extract of *Vitex negundo* (EAEVN), Ethanolic extract of *Vitex negundo* (EEVN) and Aqueous extract of *Vitex negundo* (AEVN) extracts were separately dissolved in 10ml ethanol and used for the estimation.

#### Procedure

The total phenolic content of the Petroleum Ether extract of *Vitex negundo* (PEEVN), Chloroform extract of *Vitex negundo* (CEVN), Ethyl acetate extract of *Vitex negundo* (EAEVN), Ethanolic extract of *Vitex negundo* (EEVN) and Aqueous extract of *Vitex negundo* (AEVN) was determined by Folin Ciocalteu assay method. To an aliquot 100µg of extracts or standard solution of Gallic acid (20, 40, 60, 80,100 µg/ml) added 0.5ml of Folin Ciocalteu reagent and made into 2ml with distilled water and the mixture is incubated for 5 min at room temperature . 0.1ml of 20% Sodium Carbonate and 0.9ml of Distilled water were added to make the final solution to 3ml. It was incubated for 30 mins in dark to complete the reaction .After that absorbance of the mixture was measured at 725 nm against blank. Distilled water was used as reagent blank. The tests were performed in triplicate to get the mean values. The total phenolic content was found out from the calibration curve of Gallic Acid. And it was expressed as milligrams of Gallic Acid equivalents (GAE) Per gram of extract.

## RESULTS

### DPPH FREE RADICAL SCAVENGING ASSAY

Table : 1 DPPH FREE RADICAL SCAVENGING ASSAY

S No	Concentration µg/ml	% of Inhibition					
		Ascorbic Acid	PEEVN	CEVN	EAEVN	EEVN	AEVN
1	20	58.36	19.09	39.24	17.06	43.43	18.77
2	40	74.06	30.90	57.33	32.08	49.43	27.23
3	60	78.4	54.16	74.06	56.99	59.64	37.55
4	80	81.56	71.87	75.42	66.55	65.80	39.43
5	100	89.07	76.04	76.45	79.18	85.73	53.52





### Vinciya and Rani

#### IC 50 Value of different extracts and standard

Table : 2 IC 50 Value of DPPH Free Radical Scavenging Assay

Plant extract/ Standard	IC 50 Value ( $\mu\text{g/ml}$ )
Ascorbic Acid	31.70
PEEVN	59.95
CEVN	59.86
EAEVN	49.07
EEVN	44.82
AEVN	92.38

#### Determination of Nitric Oxide Scavenging Assay

Table : 3 Determination of Nitric Oxide Scavenging Assay

S. No	Concentration $\mu\text{g/ml}$	% of Inhibition					
		Ascorbic Acid	PEEVN	CEVN	EAEVN	EEVN	AEVN
1	20	61.16	18.86	10.90	14.59	17.57	19.05
2	40	73.88	39.6	24.61	21.03	24.26	22.46
3	60	79.03	42.27	31.74	22.74	29.28	25.30
4	80	82.81	49.43	35.10	39.91	45.60	30.57
5	100	90.03	53.17	42.51	63.94	69.03	35.11

#### IC 50 Value of different extracts and standard

#### Determination of Nitric Oxide Scavenging Assay

Table : 4 IC 50 Value of Nitric Oxide Scavenging Assay

Plant extract / Standard	IC 50 Value ( $\mu\text{g/ml}$ )
Ascorbic Acid	30.511
PEEVN	81.31
CEVN	111.93
EAEVN	90.45
EEVN	40.69
AEVN	141.77

#### Hydrogen Peroxide Radical Scavenging Assay:

Table : 5 Hydrogen Peroxide Radical Scavenging Assay

S. No	Concentration $\mu\text{g/ml}$	% of Inhibition					
		Ascorbic Acid	PEEVN	CEVN	EAEVN	EEVN	AEVN
1	20	57.19	13.52	14.44	46.73	46.80	18.99
2	40	72.28	33.09	29.62	58.76	49.10	27.0
3	60	75.08	51.60	51.48	72.56	58.86	37.9
4	80	81.05	65.12	68.88	75.25	63.73	39.81
5	100	92.28	74.7	76.29	78.35	86.34	60.66





**Vinciya and Rani**

**Hydrogen Peroxide Radical Scavenging Assay**

**IC 50 Value of different extracts and standard**

**Table : 6 IC 50 Value Of Hydrogen Peroxide Radical Scavenging Assay**

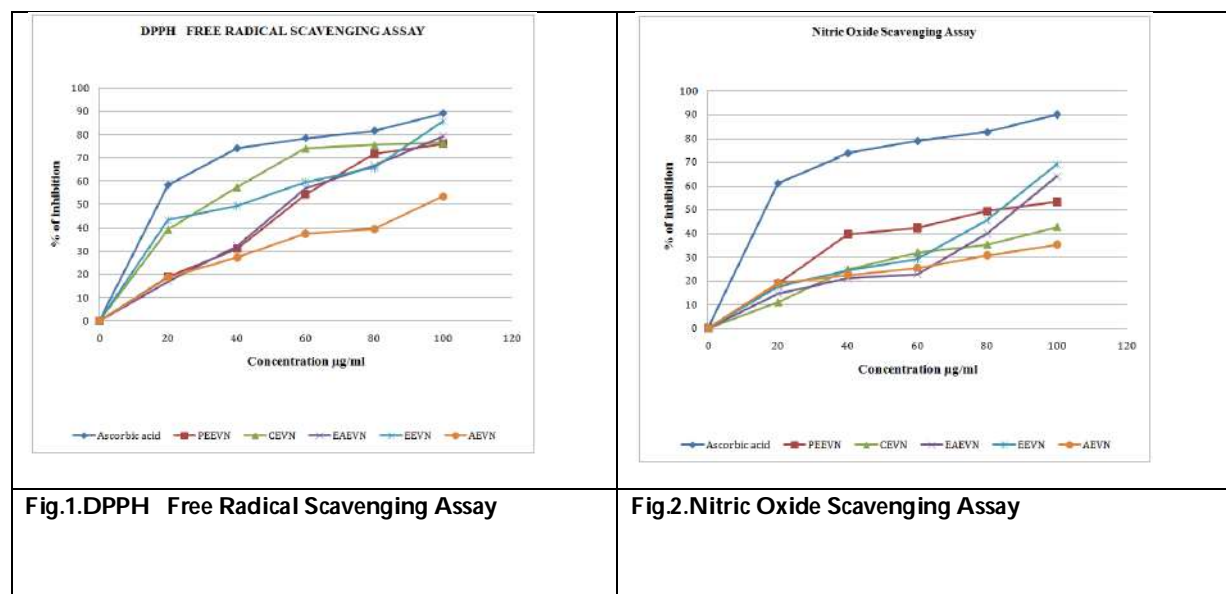
Plant extract/ Standard	IC 50 Value (µg/ml)
Ascorbic Acid	42.48
PEEVN	58.16
CEVN	62.20
EAEVN	48.85
EEVN	48.85
AEVN	85.81

**Determination of Total Phenolic content:**

Total Phenolic Content of PEEVN was found to be 40.10 mg Gallic acid Equivalents / g plant Extract.  
 Total Phenolic Content of CEVN was found to be 29.41 mg Gallic acid Equivalents / g plant Extract.  
 Total Phenolic Content of EAEVN was found to be 42.10 mg Gallic acid Equivalents / g plant Extract.  
 Total Phenolic Content of EEVN was found to be 77.82 mg Gallic acid Equivalents / g plant Extract.  
 Total Phenolic Content of AEVN was found to be 21.83 mg Gallic acid Equivalents / g plant Extract.

**Determination of Total Flavonoid content:**

Total Flavonoid Content of PEEVN was found to be 12.10 mg Quercetin Equivalents / g plant Extract.  
 Total Flavonoid Content of CEVN was found to be 9.03 mg Quercetin Equivalents / g plant Extract.  
 Total Flavonoid Content of EAEVN was found to be 20.82 mg Quercetin Equivalents / g plant Extract.  
 Total Flavonoid Content of EEVN was found to be 30.6 mg Quercetin Equivalents / g plant Extract.  
 Total Flavonoid Content of AEVN was found to be 8.81 mg Quercetin Equivalents / g plant Extract.





Vinciya and Rani

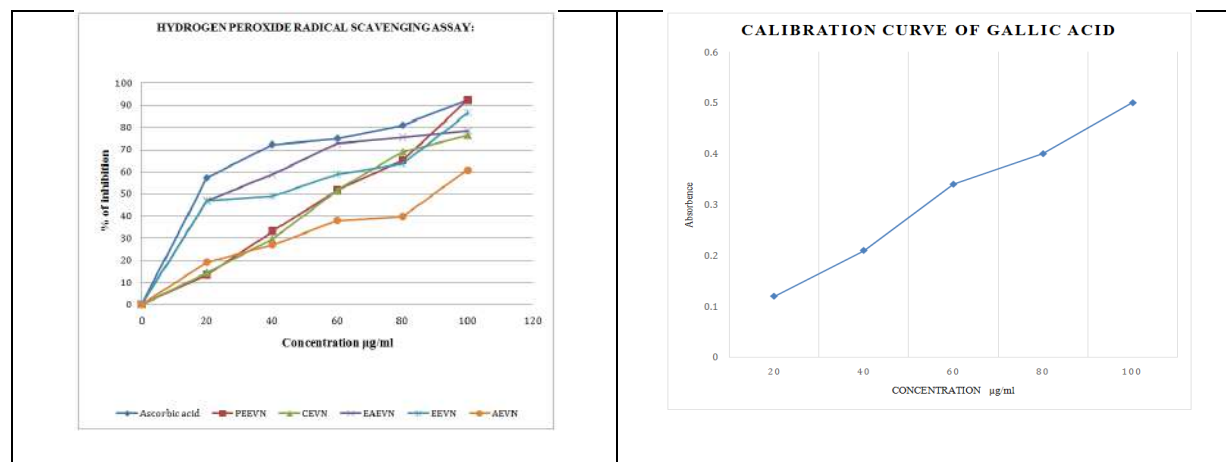


Fig.3. Hydrogen peroxide radical scavenging assay

Fig.4. Calibration Curve of GALLIC ACID

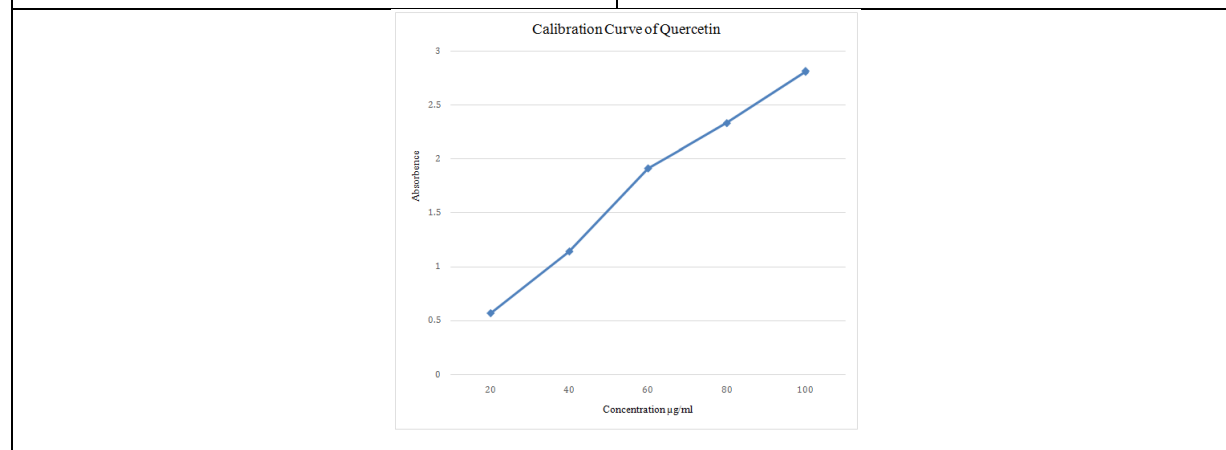


Fig.5. Calibration Curve of Quercetin

DISCUSSION

**In vitro antioxidant studies on the extracts**

The antioxidant activity of Petroleum Ether extract of *Vitex negundo* (PEEVN), Chloroform extract of *Vitex negundo* (CEVN), Ethyl Acetate extract of *Vitex negundo* (EAEVN), Ethanolic extract of *Vitex negundo* (EEVN) and Aqueous extract of *Vitex negundo* (AENV) was assessed by three methods namely DPPH free radical scavenging assay, Nitric Oxide scavenging assay, Hydrogen Peroxide radical scavenging assay. A lower value IC<sub>50</sub> observed for Ethanolic extract of *Vitex negundo* (EEVN) (44.82 µg/ml) in DPPH free radical scavenging assay compared to that of the other extracts. It indicates the antioxidant potential possessed by the Ethanolic extract is greater than that of the other extracts. However the antioxidant efficacy of the Ethanolic extract is lower than that of the standard Ascorbic Acid. A lower value IC<sub>50</sub> observed for Ethanolic extract of *Vitex negundo* (EEVN) (40.69 µg/ml) in Nitric Oxide scavenging assay compared to that of the other extracts. It indicates the antioxidant potential possessed by the Ethanolic extract is greater than that of the other extracts. However the antioxidant efficacy of the Ethanolic extract is lower than that of the standard Ascorbic Acid. A lower value IC<sub>50</sub> observed for Ethanolic extract of *Vitex negundo* (EEVN) (48.85 µg/ml) in Hydrogen Peroxide radical scavenging assay compared to that of the other extracts. It indicates the antioxidant potential possessed by the Ethanolic extract is greater than that of the other extracts. However the antioxidant efficacy of the Ethanolic extract is lower than that of the standard Ascorbic Acid. The scavenging activity



**Vinciya and Rani**

was increased as the extract concentration was increased. All the extracts showed good antioxidant activity but the Ethanolic extract of *Vitex negundo* (EEVN) has more antioxidant activity.

Total Phenolic content of PEEVN was found to be 40.10 mg Gallic Acid equivalents / g plant extract.  
Total Phenolic content of CEVN was found to be 29.41 mg Gallic Acid equivalents / g plant extract.  
Total Phenolic content of EAEVN was found to be 42.10 mg Gallic Acid equivalents / g plant extract.  
Total Phenolic content of EEVN was found to be 77.82 mg Gallic Acid equivalents / g plant extract.  
Total Phenolic content of AEVN was found to be 21.83 mg Gallic Acid equivalents / g plant extract.

Quantitative studies confirm the total phenolic content is more in EEVN was found to be 77.82 mg Gallic Acid equivalents / g plant extract .

Total Flavonoid content of PEEVN was found to be 12.10 mg Quercetin equivalents / g plant extract.  
Total Flavonoid content of CEVN was found to be 9.03 mg Quercetin equivalents / g plant extract.  
Total Flavonoid content of EAEVN was found to be 20.82 mg Quercetin equivalents / g plant extract.  
Total Flavonoid content of EEVN was found to be 30.6 mg Quercetin equivalents / g plant extract.  
Total Flavonoid content of AEVN was found to be 8.81 mg Quercetin equivalents / g plant extract.

The total Phenolic content in EEVN was found to be 30.6 mg Quercetin Equivalents / g plant extract.

From the results of qualitative analysis, Ethanolic extract of *Vitex negundo* (EEVN) has maximum Phenolic and Flavonoid content compared with other extracts. By inducing antioxidant defence system, drug metabolising enzymes, modulating diverse events at the cellular level, and inhibiting inflammation, hyperplasia, proliferation, and oxidative DNA damage, phenolics and flavonoids play an important role in the prevention and therapy of cancer, as well as many other diseases.

## CONCLUSION

From the results of this research it was concluded that leaf extract of *Vitex negundo* has higher concentration of phenolic and flavonoid content and these phenolic and flavonoid contents has the important medicinal property. The free radical scavenging activity is one of the mechanisms of a plant to exhibit antioxidant activity. The polarity of compounds also plays a key role in their bioactivity. This research work is useful to animal study on leaf extract of vitex negundo, Isolation of active principles and detection of exact mechanism.

## REFERENCES

1. Alagar RM, Sahithi G, Vasanthi R, David B, Rao KNV, Selvakumar D. Study of phytochemical and antioxidant activity of Cucumis melo var. agrestis fruit. Journal of Pharmacognosy and Phytochemistry. 2015; 4(2):303-306.
2. Gopala Satheesh Kumar K, Ariharasiva Kumar G, Sengottuvel T et al. Confirmation of Best Method for Detection of Alpha Amylase Activity of Cucumis Melo Var Agrestis (Wild Musk Melon). J Adv Res Bio Chem Pharma 2019; 2(1): 1-3.
3. Gopala Satheesh Kumar K, Parthiban S, Manimaran T, Boopathi T. Phytochemical Screening on Various Extracts (Benzene, Ethanolic and Aqueous) of Stem Parts of Zanthoxylum Rhetsa (Roxb.) Dc. ijupbs. 2017; 6(2):79-91.
4. Karthishwa K, Mirunalini S, Dhamodharan G, Krishnaveni M, Arulmozhi V. Phytochemical Investigation of Methanolic Extract of the Leaves of Pergulariadaemia. Journal of Biological Sciences. 2010; 10(3):242-246.
5. Trease GE, Evans WC. Textbook of Pharmacognosy. 12th edn. Balliere Tindall and Company Publisher, London.1983 pp. 343- 383.
6. Sharma A, Joshi N, Kumar R, Agrawal P, Prasad S. High performance liquid chromatographic analysis of phenolic compounds and their antioxidant properties from different cultivars of Cyamopsis Tetragonoloba (L.) Taub. Microchemical Journal. 2017; 133: 622-628.



**Vinciya and Rani**

7. Andriyani R, Budiati T, Pudjiraharti S. Effect of Extraction Method on Total Flavonoid, Total Phenolic Content, Antioxidant and Antibacterial Activity of Zingiberis Officinale Rhizome. *Procedia Chemistry*. 2015; 16:149-154.
8. Alves D, Maia de Morais S, Tomiotto-Pellissier F, Miranda-Sapla M, Vasconcelos F, Silva I et al., Flavonoid Composition and Biological Activities of Ethanol Extracts of Caryocarcoriaceum Wittm., a Native Plant from Caatinga Biome. *Evid Based Complement Alternat Med*. 2017; 2017:1-7.
9. Chekroun E, Benariba N, Adida H, Bechiri A, Azzi R, Djaziri R. Antioxidant activity and phytochemical screening of two Cucurbitaceae: *Citrullus Colocynthis* fruits and *Bryoniadiioca* roots. *Asian Pacific Journal of Tropical Disease*. 2015; 5(8):632-637.
10. Sharma N, Suric J, Chandana BK, Singha B, Sattib N, Prabhakar A, Gupta BD, Mowkshikhullara, Ahmeda Z, Protective effect of a standardized fraction from *Vitex negundo* Linn. against acetaminophen and galactosamine induced Hepatotoxicity in rodents, *Biochemistry & Analytical Biochemistry*, 5(2), 2016, 1-9. DOI: 10.4172/2161-1009.1000267.
11. Ullah Z, Ullah R, Ali Shah AUH, Ahmed I, Haider S, Phytochemical and Biological Evaluation of *Vitex negundo* Linn: A review, 3(8), 2012, 2421-2431. DOI: 10.13040/IJPSR.0975-8232.3(8).2421-31.
12. Devi NT, Jhansi Rani PR, Thievaprakasham H, Arumugam S, Nachiappan Vignesh RM, Estimation of micronutrients in *Vitex negundo* L. (Karunochi) leaves, 3(1), 2016, 13-17. DOI: 10.15613/ijrfrn/2016/v3i1/108901
13. Nyeem Mohammad AB, Haq Md. Obaidul, Ali Md. Moksed, Ahmed N, Uddin H, Nowrose M (2017). *Nishinda* (*Vitex negundo* Linn) - A valuable medicinal plant used in herbal medicine, *International Journal of Advanced Educational Research*, 2(2), 2017, 25-31. DOI: doi.org/10.22271/educationjournal.
14. Tandon VR, Gupta RK. *Vitex negundo* Linn (VN) leaf extract as an adjuvant therapy to standard anti-inflammatory drugs. *Indian Journal of Medical Research*, 124, 2006, 447- 450. PMID: 17159267.
15. Kumar SK, Nagaveni P, Anitha P, Mahboob Subahan TM, Evaluation of anti-inflammatory activity of *Vitex negundo* Linn., *Journal of Drug Delivery and Therapeutics*, 3(2), 2013, 41-44. DOI: 10.22270/jddt.v3i2.451.
16. Kulkarni RR, Virkar DD, D'mello P, Antioxidant and antiinflammatory activity of *Vitex negundo*, *Indian Journal of Pharmaceutical Sciences*, 70(6), 2008, 838-840. DOI: 10.4103/0250- 474X.49140; PMID: 21369459.
17. Devi PR, Kumari K, Kokilavani C, Effect of *Vitex negundo* leaf extract on the free radical scavengers in complete Freund's adjuvant induced arthritic rats. *Indian Journal of Clinical Biochemistry*, 22(1), 2007, 143-147. DOI: 10.1007/BF02912899; PMID: 23105670.
18. Deograde SM, Pandya T, Prasad SK, Kale K, Tankhiwale N, Antimicrobial activity of *Vitex negundo* Linn (Nirundi) leaves extract, *Journal of Research in Traditional Medicine*, 2(4), 2016, 99-102. DOI: 10.21276/jrtm.2016/206.
19. Devi PR, Kokilavani R, Poongothai SG. Antimicrobial activity of the various leaf extracts of *Vitex negundo* Linn. *Anc Sci Life*, 28(2), 2008, 15-18. DOI: 10.4103/0257-7941.179875 PMID: 22557282.
20. Kadir FA, Kassim NM, Abdulla MA, Yehye WA. PASS predicted *V negundo* activity: antioxidant and antiproliferative properties on human hepatoma cells-an in vitro study. *BMC Complement Altern Med*. 13:343, 2013. DOI: 10.1186/1472-6882-13-343; PMID: 24305067







## Effect of Augmented Otago Exercises on Balance and Dynamic Postural Control in Older Adults

Tamilnidhi P K<sup>1\*</sup> Arunachalam R<sup>2</sup> and Anand V<sup>3</sup>

<sup>1</sup>Ph.D Scholar, Madhav University, Rajasthan, Professor, PGP College of Physiotherapy, Namakkal, Tamil Nadu, India.

<sup>2</sup>Principal, College of Physiotherapy, Madhav University, Rajasthan, India.

<sup>3</sup>Professor, College of Physiotherapy, Madhav University, Rajasthan, India.

Received: 15 Dec 2021

Revised: 22 Dec 2021

Accepted: 13 Jan 2022

### \*Address for Correspondence

#### Tamilnidhi P K

Ph.D Scholar,  
Madhav University, Rajasthan,  
Professor, PGP College of Physiotherapy,  
Namakkal, Tamil Nadu, India.



This is an Open Access Journal / article distributed under the terms of the **Creative Commons Attribution License** (CC BY-NC-ND 3.0) which permits unrestricted use, distribution, and reproduction in any medium, provided the original work is properly cited. All rights reserved.

### ABSTRACT

Aging is a series of process which occurs between life and continue throughout the life cycle. As the age advances, there will be a decline in physical health and functioning. Balance deficits are more common following aging, the drop of balance would cause falls. Falls or the fear of falls are the primary reason for immobility and mortality in older adults. This study aimed to identify the effect of Augmented Otago exercises on balance and dynamic postural control in older adults. This study is conducted in the outpatient department of Physiotherapy, PGP College of Physiotherapy, Namakkal, India. Recruited volunteers for this study in and around the college campus, Namakkal. Seventy-five volunteers were taken for the study; they were all divided into two groups using a computer-assisted method with thirty participants in each group. Two participants withdrew from each group, and the study was completed with 28 participants. Written consent was obtained from all the participants before the study. Group A receives Conventional balance training exercises for 30 minutes. Group B gets Augmented Otago exercises for 30 minutes. The exercise program was conducted for 12 weeks duration. The Time up and go test is used for the balance measurement. A modified clinical test of sensory interactions in balance (mCTSIB) is used to assess postural control. The data was collected on the first visit and at the end of 36 sessions of treatment. Used the SPSS statistical package 24.0 to analyze the collected data. The parametric test was used to determine the changes between the pre-test and post-test on balance and postural control. Results were considered significant at  $p < 0.05$ . Thus, the study concluded that Augmented Otago exercises group and Conventional exercises group showed improvement in balance and postural control. While comparing the two groups, it was noted that the Augmented Otago exercises group had shown more significant improvement when compared with the Conventional exercises.



**Tamilnidhi et al.,**

**Keywords:** Older adults, Augmented Otago exercises, Conventional balance exercises, Time up and go test, mCTSIB.

## INTRODUCTION

Aging is a global phenomenon; every country experiences a substantial older population growth [1]. The number of people aged 60 years and older adults in the population is increasing. In 2019, the number of people aged 60 years and more senior was 1 billion. This number will be increase to 1.4 billion by 2030 and 2.1 billion by 2050 [2]. India is the second-largest populated country globally, with over 1.21 billion people who are older in 2011. The percentage of older adults above 60 years is 8.6% of the total population. This is likely to rise to 198 million in 2030 [3,4]. Injuries in elders are an emerging problem in older adults. Falls occurs as an event resulting in a person coming to rest inadvertently on the floor, often caused by multifactorial risk like intrinsic and extrinsic factors [5]. Reduction in muscle mass and strength in elderly individuals generate a decreased sense of postural sway, so the reaction time of the motor nerve becomes slower, which predisposes to the frequency of falls [6]. WHO reports that falls in aged people above 65 years are about 28%—35% in each year, and this proportion increases as age and fragility level increases [7]. In India, the falls are about 14%—53% [8]. Falls in older adults occur due to a mismatch between an individual's perception, physiological function, environment, and behavior [9]. Studies have reported that falls have had many negative impacts on older adults, and there is a substantial increase in fear of falls [10]. In addition, the falls may also lead to the post-fall syndrome, which includes dependency, loss of autonomy, confusion, immobilization, and depression [11]. Falls may contribute to an increased risk of future falls and affects the Quality of life [12].

Falls management are multifaceted which includes exercises, footwear management, environment modification, vision correction, and medications [13]. Physiotherapy plays a significant role in the prevention and rehabilitation of falls in elders [14]. Researches show there is strong evidence of exercise's effect on preventing falls in community-dwelling older people [15,16]. Exercises like strengthening and balance training improve balance and fall prevention which was reported in the literature. Balance exercises play a significant role in preventing falls in elders [17,18]. Augmented Otago exercises are one of the best exercises which prevent falls in elders. It was stated that Otago exercises avoid 35% of falls in community-dwelling older people [19]. These exercises consist of progressive resisted strength training, balance training, and aerobic exercises [20]. It improves the strength, balance, and physical performance in older adults [19]. Augmented exercises have been developed recently in improving balance in older adults. This study was conducted to investigate the effect of augmented Otago exercises on balance and postural control in older adults.

## METHODOLOGY

This study was approved by the Institutional ethical committee, Madhav University, Rajasthan, India. The study was conducted in the outpatient department, PGP College of Physiotherapy, Namakkal, India. Volunteers for this study were recruited in and around the college campus, Namakkal. A survey was conducted to identify the populations for the study. Around 180 older adults who fulfilled the inclusion criteria were noted down and selected for the next selection for this study. Blinded assessor evaluates each volunteer and selects the study participants. Assessor recruit only seventy-five volunteers to be involved in the study; they were all divided into two groups using a computer-assisted method with thirty participants. The rest of the fifteen volunteers were not included. Written consent was obtained from all the participants before the study. Volunteers in Group A receive conventional balance training exercises for 30 minutes. Group B gets augmented exercises for 30 minutes. Five minutes of warmup and ten minutes of cool down were also given to all the participants. The exercise program was conducted for 12 weeks, and every participant should come on alternate days (3 times a week). Inclusion criteria of this study include 1) age group of



**Tamilnidhi et al.,**

60—70 years, 2) without any comorbid conditions (Diabetic or hypertension), 3) volunteers able to walk 10 meters without support 4) without pain in the lower limbs 5) without any recent injuries to the lower limbs 6) without any balance problems before the study 7) has a history of fall of 3 times in the last year 8) has a balance of 45 in berg balance scale 9) without any cervical or vestibular problem 10) without any cardiac or respiratory problems. All the volunteers were treated with 36 sessions. Conventional balance exercises start with warming up (stationary marching, single-leg standing, lunges, and neck exercises); main activities were standing on a single leg, tandem stance, standing on one leg on the floor, standing two-leg on the cushion, single-leg perspective on the cushion, double leg standing in foam mat and single-leg stance in foam mat, Walking normal, tandem walking, walking over the obstacles, forward walking and backward walking. All these exercises were conducted for 30 mins, and the session ended with breathing exercises and stretches [21].

Augmented exercises start with warming up (stationary marching, single-leg standing, lunges, and neck exercises); main exercises were walking forward, backward, turning around, heel walking, toe walking, one leg stand, stair walking, sit to stand, hopping, and single-leg hop. All these exercises were conducted for 30 mins, and the session ended with breathing exercises and stretches [22]. The blinded assessor measures the initial and final values of the selected parameters. The time up and go test is used for the balance measurement, and the Modified clinical test of sensory interactions in balance (mCTSIB) is used to assess postural control. The data was collected on the first visit of the volunteer and the end of 36 sessions of treatment. The SPSS statistical package 24.0 was used to analyze the collected data. The dependent variables are balance and postural control. General characteristics of the subjects and variables followed a normal distribution. The parametric test was used to determine the changes between the pre-test and post-test on balance and postural control. Results were considered significant at  $p < 0.05$ . Following four weeks of treatment, two participants in the group A, withdrew due to sickness, and two participants from group B withdrew due to relocation. So, this study was completed with twenty-eight participants in each group.

## RESULTS

This study uses SPSS statistical package 24.0, and the data were analyzed using a parametric test displayed in Table I and Table II. The values of the within-group analysis are shown in Table I. The analysis shows a significant difference obtained between the pre interventions and the post interventions. This indicates that both the groups are showing effectiveness in the application of the interventions. The study did all the analysis with the critical value of  $p < 0.05$ . The between-group analysis is shown in Table II. This analysis indicates that the group who underwent augmented Otago exercises shows a significance than the balance training group. The effect size of the TUG test was calculated using Cohen's  $d$  is 0.9295, which shows more considerable importance between the groups; the effect size of the mCTSIB test with Cohen's  $d$  is 1.569, which is also offering a more remarkable effect between the groups. So, the analysis identified that the group with Augmented Otago exercises showed a significant improvement compared with the balance training alone. So, this study rejects the Null hypothesis.

## DISCUSSION

This study aimed to identify the effect of Augmented Otago exercises on balance and dynamic postural control in older adults. Falls in older adults are a prevalent and significant problem to handle since they can have devastating consequences [9]. Poor balance can lead to falls in elders; in addition, the impaired balance may reduce independence, reduced mobility, and reduced activities of daily living [23]. Falls can lead to poor quality of life and turn to illness and premature death [24]. Physiotherapy interventions play a pivotal role in reducing balance, improving mobility, and improving quality of life [16]. Exercises have been one of the most useful to reduce falls in older people. Physiotherapists can also help with compensating tactics and deciding whether to try rehabilitation rather than compensation. Structured physiotherapy interventions are applied to prevent or reduce falls in elders [14].



**Tamilnidhi et al.,**

Exercise is an obvious choice as a fall prevention intervention because impaired muscle strength and poor postural control increase the risk of falling and are amendable to change with exercise[16]. Exercises preserve the motor units and mitochondrial functions, prevent muscle atrophy and improve the health-related quality of life[25]. Balance training stimulates the vestibular, neuromuscular, and proprioceptive systems, which sends signals to the brain and vestibular nuclei, thereby improving balance and postural control [26,27]. A recent meta-analysis identified that exercises are optimal for enhancing functional performances, and it prevents fall risks in community-dwelling older adults with a chance of fall [28]. Otago exercises improve the muscles' strength in the lower limbs, thereby providing a good balance. In addition, muscle strengthening aids to maintain the body in the normal posture and improves the dynamic posture [29,30]. Augmented Otago exercises aids in improving the walking patterns, maintaining the erect posture, postural control over the body, and regaining balance [31]. Otago exercises assisted in improving the walking posture and maintaining muscle activity which helps to bring balance in older adults [22].

Recent literature suggests that the Otago exercises are very effective in fall prevention, improve balance function, and reduce the fear of falling [32, 33,34]. Similarly, Martin et al.,[35], has reported that the Otago exercises improve balance and functional ability. Various metanalysis also shows that Otago exercises enhance the fear of falls and mobility in older adults [36]. All this literature has provided vital support to this study. The study analysis also supports that the application of augmented Otago exercises has shown significant improvement in the balance and postural control compared with the balance exercises only. However, the limitations of this study are the smaller duration of the study, unequal gender size, and analyzed the smaller locations. Thus, the study concluded that Augmented Otago exercises and the balance exercises show improvement in balance and postural control. While comparing the two groups, noted that the Augmented Otago exercises group had shown more significant improvement when compared with the balance exercises alone.

**ACKNOWLEDGMENT**

We acknowledge the cooperation of all the volunteers for their active participation in this study. We also thank the Management of the PGP College for providing infrastructures and supporting to conduct of the study on the campus.

**CONFLICT OF INTEREST**

None declared by the author.

**REFERENCES**

1. Ingle GK, Nath A. Geriatric health in India: concerns and solutions. Indian J Community Med. 2008;33(4):214-218. doi:10.4103/0970-0218.43225.
2. Centres for Disease Control and Prevention. (2017). Important Facts About Falls. Retrieved from <https://www.cdc.gov/homeandrecrationalafety/falls/adultfalls.html>[Last accessed on 2021 Aug 21]
3. Government of India Ministry of Statistics and Programme Implementation, Central Statistics Office. Elderly in India; 2016. Available from: [http://www.mospi.nic.in/sites/default/files/publication\\_reports/ElderlyinIndia\\_2016.pdf](http://www.mospi.nic.in/sites/default/files/publication_reports/ElderlyinIndia_2016.pdf). [Last accessed on 2021 June 14].
4. HelpAge International. Ageing in the 21st Century: A Celebration and A Challenge. New York: UNFPA.2012.
5. Pitchai P, Dedhia HB, Bhandari N, Krishnan D, D'Souza NR, Bellara JM. Prevalence, risk factors, circumstances for falls and level of functional independence among geriatric population - A descriptive study. Indian J Public Health 2019;63:21-6.
6. Campbell AJ, Robertson MC, La Grow SJ, et al. : Randomised controlled trial of prevention of falls in people aged > or =75 with severe visual impairment: the VIP trial. BMJ, 2005, 331: 817–820



**Tamilnidhi et al.,**

7. World Health Organization. WHO Global Report on Falls Prevention in Older Age. Available from: [http://www.who.int/ageing/publications/Falls\\_prevention7March.pdf](http://www.who.int/ageing/publications/Falls_prevention7March.pdf). [Last accessed on 2021Jun 21]
8. Dsouza SA, Rajashekar B, Dsouza HS, Kumar KB. Falls in Indian older adults: A barrier to active ageing. *Asian J Gerontol Geriatr* 2014;9:33-40.
9. Sherrington C, Tiedemann A. Physiotherapy in the prevention of falls in older people. *J Physiother*. 2015 Apr;61(2):54-60. doi: 10.1016/j.jphys.2015.02.011
10. Mane AB, Sanjana T, Patil PR, Srinivas T. Prevalence and correlates of fear of falling among elderly population in urban area of Karnataka, India. *J Midlife Health* 2014;5:150-5
11. Mitchell-Fearon K, James K, Waldron N, Holder-Nevels D, Willie-Tyndale D, Laws H, et al. Falls among community-dwelling older adults in Jamaica. *SAGE Open* 2014;4:1-9.
12. Saikia Ashok M, Das AK, Saikia Anjana M. Prevalence and correlates of falls among community-dwelling elderly of Guwahati city, Assam. *Indian J Basic Appl Med Res* 2016;5:185-19
13. Moncada LV. Management of falls in older persons: a prescription for prevention. *Am Fam Physician*. 2011;1:84(11):1267-76.
14. Sherrington C, Tiedemann A, Fairhall N, Close JCT, Lord SR. Exercise to prevent falls in older adults: an updated meta-analysis and best practice recommendations. *NSW Public Health Bulletin*. 2011;22:78–83.
15. Martin JT, Wolf A, Moore JL, Rolenz E, DiNinno A, Reneker JC. The effectiveness of physical therapist-administered group-based exercise on fall prevention: a systematic review of randomized controlled trials. *J Geriatr Phys Ther*. 2013;36(4): 182–193.
16. Gillespie LD, Robertson MC, Gillespie WJ, Lamb SE, Gates S, Cumming RG, et al. Interventions for preventing falls in older people living in the community. *Cochrane Database Syst Rev*. 2012.
17. Ashburn A, Fazakarley L, Ballinger C, Pickering R, McLellan LD, Fitton C. A randomised controlled trial of a home-based exercise programme to reduce the risk of falling among people with Parkinson's disease. *J Neurol Neurosurg Psychiatry*. 2007;78(7):678–84.
18. Gillespie LD, Gillespie WJ, Robertson MC, et al. Interventions for preventing falls in elderly people (Cochrane Review). In: *The Cochrane Library*, Issue 2. Oxford: Update Software, 2002.
19. Robertson MC, Campbell AJ, Gardner MM, Devlin N. Preventing injuries in older people by preventing falls: a meta-analysis of individual-level data. *J Am Geriatr Soc*. 2002;50(5):905–911.
20. Gardner MM, Buchner DM, Robertson MC, et al.: Practical implementation of an exercise-based falls prevention programme. *Age Ageing*, 2001, 30: 77–83
21. Halvarsson, A., Dohrn, I. M., & Stähle, A. Taking balance training for older adults one step further: the rationale for and a description of a proven balance training programme. *Clinical rehabilitation*, 2015;29(5), 417–425.
22. Yoo HN, Chung E, Lee BH. The Effects of Augmented Reality-based Otago Exercise on Balance, Gait, and Falls Efficacy of Elderly Women. *J Phys Ther Sci*. 2013;25(7):797-801. doi:10.1589/jpts.25.797.
23. Delbaere K, Close JCT, Brodaty H, Sachdev P, Lord SR. Determinants of disparities between perceived and physiological risk of falling among elderly people: cohort study. *BMJ*. 2010;341:c4165.
24. Howe TE, Rochester L, Neil F, et al. Exercise for improving balance in older people. *Cochrane Database Syst Rev*. 2011;11:CD004963.
25. Navas-Enamorado I, Bernier M., Brea-Calvo G., de Cabo R. Influence of anaerobic and aerobic exercise on age-related pathways in skeletal muscle. *Ageing Res. Rev*. 2017; 37, 39–52.
26. Taube W., Gruber M., Beck S., Faist M., Gollhofer A., Schubert M. Cortical and spinal adaptations induced by balance training: correlation between stance stability and corticospinal activation. *Acta Physiol*. 2007; 189:347–358.
27. Smith P. F., Zheng Y. From ear to uncertainty: vestibular contributions to cognitive function. *Front. Integr. Neurosci*. 2013; 7:84.
28. Teng B, Gomersall SR, Hatton A, Brauer SG. Combined group and home exercise programmes in community-dwelling falls-risk older adults: Systematic review and meta-analysis. *Physiotherapy research international*. 2020;25(3): e1839.
29. Daubney ME, Culham EG. Lower-Extremity Muscle Force and Balance Performance in Adults Aged 65 Years and Older. *Phys Ther*. 1999 Dec 1;79(12):1177–85.





**Tamilnidhi et al.,**

30. Porto JM, Freire Júnior RC, Bocarde L, Fernandes JA, Marques NR, Rodrigues NC, et al. Contribution of hip abductor-adductor muscles on static and dynamic balance of community-dwelling older adults. *Aging Clin Exp Res.* 2019;31(5):621–7.
31. Chiu HL, Yeh TT, Lo YT, Liang PJ, Lee SC. The effects of the Otago Exercise Programme on actual and perceived balance in older adults: A meta-analysis. *PLoS One.* 2021; 16(8):e0255780.
32. Liu-Ambrose T, Donaldson MG, Ahamed Y, Graf P, Cook WL, Close J, et al. Otago home-based strength and balance retraining improves executive functioning in older fallers: a randomized controlled trial. *J Am Geriatr Soc.* 2008 Oct;56(10):1821–30.
33. Bjerk M, Brovold T, Skelton DA, Liu-Ambrose T, Bergland A. Effects of a fall's prevention exercise programme on health-related quality of life in older home care recipients: a randomized controlled trial. *Age Ageing.* 2019;48(2):213–9.
34. Kocic M, Stojanovic Z, Nikolic D, Lazovic M, Grbic R, Dimitrijevic L, et al. The effectiveness of group Otago exercise program on physical function in nursing home residents older than 65 years: A randomized controlled trial. *Arch Gerontol Geriatr.* 2018;75:112–8.
35. Martins AC, Santos C, Silva C, Baltazar D, Moreira J, Tavares N. Does modified Otago Exercise Program improves balance in older people? A systematic review. *Prev Med reports.* 2018;11:231–9.
36. Thomas S, Mackintosh S, Halbert J. Does the "Otago exercise programme" reduce mortality and falls in older adults?: a systematic review and meta-analysis. *Age Ageing.* 2010;39(6):681–7.

**Table I. Intervention analysis within groups**

Characteristics	Pre test (Mean ± SD)	Post test (Mean± SD)	Paired 't' value	Level of Significance
TUG Group A	14.73 ±0.825	12.30 ± 0.724	12.43 ± 0.195	p < 0.0001
TUG Group B	14.78±0.836	10.54 ± 2.578	7.70 ± 0.551	p < 0.0001
mCTSIB test Group A	78.04 ± 10.77	91.07 ± 6.98	10.97 ± 1.189	p < 0.0001
mCTSIB test Group B	79.64 ± 10.10	101.43 ± 6.2	8.55 ±2.549	p < 0.0001

**Table II . Intervention analysis between groups**

Characteristics	Group A (Mean ± SD)	Group B (Mean± SD)	Paired 't' value	Level of Significance
TUG	12.30 ± 0.724	10.54 ± 2.578	3.493 ± 0.531	p < 0.0096
mCTSIB	91.07 ± 6.98	101.43 ± 6.2	5.683 ± 1.685	p < 0.0001





## Impact of Heavy Metal Zinc on the Testis of Zebra Fish (*Branchydanio rerio*)

P. Sasikala<sup>1\*</sup> S. Ravichandran<sup>2</sup> and T. Ramesh kumar<sup>3</sup>

<sup>1</sup>Ph.D Research Scholar, Department of Zoology, Annamalai University, Annamalainagar, Chidambaram, Tamil Nadu, India

<sup>2</sup>Associate Professor, Department of Zoology, Annamalai University, Annamalainagar, Chidambaram, Tamil Nadu, India

<sup>3</sup>Professor, Co-ordinator, DDE Wing, Department of Zoology, Annamalai University, Annamalainagar, Chidambaram, Tamil Nadu, India.

Received: 16 Nov 2021

Revised: 18 Dec 2021

Accepted: 24 Jan 2022

### \*Address for Correspondence

#### P. Sasikala

Ph.D Research Scholar,  
Department of Zoology,  
Annamalai University, Annamalainagar,  
Chidambaram, Tamil Nadu, India  
Email: sasikalag1695@gmail.com



This is an Open Access Journal / article distributed under the terms of the **Creative Commons Attribution License** (CC BY-NC-ND 3.0) which permits unrestricted use, distribution, and reproduction in any medium, provided the original work is properly cited. All rights reserved.

### ABSTRACT

The aquatic environment is continuously being contaminated with chemicals from industrial, agricultural and domestic activities zinc is an essential trace element for terrestrial as well as aquatic organisms. However, at excessive uptakes, zinc can be toxic. One of the great advantages of environmental monitoring in that this category of examining specific target organs including gills, brain, liver and kidney. The kidneys of freshwater fishes are largely dedicated to the production of copious dilute urine and it has major responsibility for iron or acid - base balance. In the present study, an attempt has been made to observe the changes in the kidney of the freshwater zebrafish exposed to sub lethal concentration of zinc for 10-30 days.

**Keywords:** Aquatic, industries, agricultural, toxic, acid- base balance, histology

### INTRODUCTION

Pollution refers to the contamination of the environment with harmful and undesirable wastes. Pollutants have now become a part with in the conventional crimes. As water was scarce and its demand was likely to increase further it needs more attention. Aquatic organisms, particularly fish, accumulate pollutants directly from contaminated water and indirectly via food chain (Sasaki *et al.*, 1997). The different chemicals are widely used to control pest of agricultural crops. Over spray and runoff of pesticides from agricultural fields may easily find their way into the



**Sasikala et al.,**

natural water surfaces and adversely affect the same which creates hazards to aquatic life it resulting in serious damage to non target species, including fishes (Lange *et al.*, 1995). Among aquatic organisms toxic substances may have many negative effects, one in particular being the potential to cause oxidative stress through enhanced generation of reactive oxygen species (ROS) or corruption of antioxidant defines system (Livingstone, 1998). The uptake of chemicals by aquatic organisms may occur from the water, sediments, suspended particulate matter and from food. The final result of exposure to contaminants depends on the particular dietary and ecological life styles of the aquatic organisms (Livingstone, 1998). It is known that aquatic organisms were more sensitive to toxicants than the terrestrial organisms. Many new chemicals especially heavy metals were released into the environment every year. The increased use and production of these chemicals are potential threats to the health, development and reproductive cycle of animals. Today standardizations of environmental and risk assessment polices were regulated by the international standard organization (ISO) (Lange *et al.*, 1995; OECD, 2006).

Toxicity tests have become more prevalent in recent years because of standardize legislation commonly used to access chemical exposure in living organisms (Weidemen, 1993). Such test may involve either mammalian or non mammalian test organisms. Fish have been used in toxicity tests for many years (Tong, 1994). The use of fish as an experimental model offers several advantages for use in toxicity testing. For example water born chemicals can enter through the gills and skin. Additionally heavy metals can be added to food or fish and administered by intraperitoneal injections. Fish offer advantages over rodents and non – rodent and primates because they were cheaper and easier to maintain in the laboratory (Tong, 1994). The zebra fish kidney consists of head and body kidneys. Head kidney is the anterior portion of the kidney and consists of lymphoid tissue. Body kidney is composed of many nephrons and interstitial lymphoid tissue. The interstitial tissue is the major haematopoietic tissue in the body. Each nephron consists of two parts, the glomerulus (G) and the urinary tubule. The glomerulus capsule consists of an inner and outer layer of single flattened epithelia. Renal tubules (RT) consist of single layer of epithelial cells. Mesangium fills the space between the loops of glomerular capillaries. Renal tubules are thin and short in the neck segment. The proximal convoluted segment is divided into two parts i.e. segment I and segment II. The renal tubules are composed of cuboidal epithelial cells with densely arranged microvilli in the tubular lumen. In segment II, renal tubules are composed of cuboidal epithelial cells. Cilia and microvilli are found in the tubular lumen. In the distal convoluted segment, epithelial cells have no microvilli. The cells of this segment are stained with eosin more faintly than those of proximal convoluted segment. Thus, it is easy to distinguish between proximal and distal convoluted segments under light microscopy (Oguri, 1982).

Zinc is the fourth most widely used metal in the world and also one of the ubiquitous elements in the world among others. The sources of zinc pollution are natural as well as anthropogenic. The animal zinc input to the environment from weathering, erosion and other natural phenomenon is estimated to be the order of 8, 00,000 tonnes (Nriagu, 1980). Anthropogenic sources contribute an estimated 414,000 tonnes of zinc per annum. On a global basis, the most important anthropogenic sources include air emissions from primary zinc production (99000 ton/year), wood combustion (75,000 ton/year), waste incineration (37, 000 ton/year), iron and steel production (35,000 ton/year), other atmospheric emissions (68,000 ton/year) and municipal waste water (1, 00,000 ton/year). Abbasi *et al* (1998) have observed an average yearly concentration of zinc 19.80 ppb higher than that of cadmium, lead, copper, nickel and cobalt. Zinc is together with cadmium and mercury a member of group IIB in the periodic table. In pure form it is a pale grayish – blue, malleable metal. Zinc normally occurs in the environment in an oxidation state of Zn. The (Zn, Fe) S minerals sphalerite and wurtzite is by far the most predominant zinc are minerals (Kiekens, 1995).

Zinc is an essential trace metal for terrestrial as well as aquatic organism. It is one of the less toxic heavy metals, but also one of the most widely occurring. However, at excessive uptakes, zinc can be toxic. Mobility of zinc varies with concentration of adsorbing material, Ph, dissolved and particulate iron and manganese concentration of completing ligands, cation exchange capacity organic content, concentration of zinc and redox potential (indirectly). Zinc adsorption is not anticipated below Ph 6.0. However, above Ph 7.0 metal oxides, clay and apatite are efficient adsorbants capable of binding 90-100% of the zinc (Kiekens 1995; WHO, 1996). Pure zinc is used mainly for protecting steel from rust (galvanization). Other very important fields of application are Zinc – base alloys, brass and





**Sasikala et al.,**

bronze, zinc semi-manufactures and chemicals. Zinc oxide is used mainly for rubber processing products, pigment, and as intermediate for zinc chemicals. Zinc chloride is used as wood preserver, in soldering fluxes, for galvanization, and as dry battery filler, zinc phosphate is used as corrosion-inhibitive pigment and material for dental cements<sup>1995</sup>. Single high or repeated lower exposures of zinc may damage the lungs, with scarring of lung tissues and may cause damage to heart muscle, liver and kidney (Al-Attar, 2007). Fish has been the main supply of cheap and healthy protein to a large percentage of the world's population. In most Asian countries, especially those in Southeast Asia, fish is a main protein of the diet. It is particularly valuable for providing proteins of high quality comparable with those of meat, milk or eggs, and is also a good source of omega-3 fatty acids; calcium and phosphorus, iron, trace elements like copper, and a fair proportion of the B-vitamins (Tucker, 1997). Beside good health benefits of fish, there were many reports on contamination of fish by chemical in the environment. The fish, as a bioindicator species, plays an increasingly important role in the monitoring of water pollution because it responds with great sensitivity to changes in the aquatic environment. The sudden death of fish indicates heavy pollution; the effects of exposure to sublethal levels of pollutants can be measured in terms of biochemical, physiological or histological responses of the fish organism (Mondon *et al.*, 2001). Changes in age and species distribution in a stock fish population are general indicators of water pollution. Biochemical markers are biochemical responses induced in the presence of a specific group of contaminants that have the same mechanism of toxic activity (Iroka and Drastichova, 2004). Succinate dehydrogenase is a primary enzyme in the oxidative catabolism of sugars (Lehninger *et al.*, 1993) and as such is used effectively as a marker of mitochondrial abundance and activity to identify any possible physiological disturbance in fishes. Hence, it was programmed to find out the effect of sublethal concentration of zinc on the kidney in Zebrafish.

## MATERIALS AND METHODS

The Zebrafish having mean length of 4 to 6 cm 20 to 50 g weight were purchased from the Quality Aquarium, Kolathur, Chennai. They were fed with tubifix worms regularly. The unused foods were removed carefully. They were given 0.1%KMNO<sub>4</sub> solution and then kept in plastic pools for acclimatization for seven days. The stock solutions were prepared by using zinc LC<sub>50</sub> was calculated for 96 h (38.64 ppm) (Sprague, 1971) and 1/5th (high), 1/10th (medium) and 1/15th (low) of the LC<sub>50</sub> values were 6.528, 3.264 and 2.176 ppm respectively taken for this study. Forty fishes were selected then it was divided into 4 groups. The first group was maintained in free from treatment and served as the control. The other 3 groups were exposed to sub lethal concentration of zinc in 10 liter capacity glass tank. The 2nd, 3rd and 4th groups were exposed to zinc for 10, 20 and 30 days respectively. At the end of each exposure period, the fish were sacrificed and the required tissues were dissected out for succinate dehydrogenase activity estimation. Fishes were exposed to three different concentrations separately in plastic troughs. The control fishes were also maintained separately. They were fed with tubifix worms as per the normal procedure. The medium was renewed daily with sublethal concentration of the zinc. The succinate dehydrogenase activities in all the tissues were estimated by the Nachales *et al.* method (1960). The data were analyzed by DMRT one way ANOVA and test the level of significance (Duncan, 1957).

## RESULT AND DISCUSSIONS

Renal tissues of the fish exposed to zinc at the concentration of 0.32 mg/L show some common pathological changes. Highly degenerative changes were observed in haemopoietic tissues which include shrinkage of glomerulus (SG), expansion of space inside Bowman's capsule (ESBC), hypertrophied cells (HTC) and lumen tubules diminished (LTD). In zinc exposure leads to intra cytoplasmic vacuoles in epithelial cells of renal tubules (icv), degenerating haemopoietic tissue with erythrocytes (DGHTE) more prominently observed. Besides the above changes severe necrosis, cloudy swelling in renal tubules and granular cytoplasm was also observed. From the body of fish, the waste products are eliminated through kidney. The non-detoxified pesticide molecules must be eliminated through the kidney of fish and hence, it is susceptible to chemical compounds when exposed to lethal or sublethal doses.



**Sasikala et al.,**

Heavy metals while it was eliminated through kidney might have caused degenerative changes in renal tubule and glomerulus. Degenerative haemopoietic tissue with erythrocytes (DGHTE) serve necrosis, cloudy swelling in renal tubules and granular cytoplasm to great extent when fishes exposed to zinc intoxication in 28 days. The uneven distribution of carbohydrate content and a drastically decrease in the hepatic cells of the freshwater teleost upon exposure to polluted waters of Hussain Sagar Lake. Tilak *et al.*, (2001c) have been reported the same degenerative changes in *Ctenopharyngodon idellus* under fenvalerate toxicity. Anita Susan and Tilak (2003) observed the toxic sub lethal concentration of fenvalerate technical grade induced atrophy, appearance of blood streaks among hepatocytes in liver of *Cirrhinus mrigala*. Similar reports were observed in liver of *Cirrhinus mrigala* was exposed to the sub lethal and lethal concentrations of technical grade and 20% EC of Chlorpyrifos (Tilak *et al.*, (2005a). Zinc induced pathological changes in the liver observed in the present study might affect the physiological activity of the fish such as reduction in enzyme synthesis and reduces the functional ability of liver which indirectly affects all metabolic activities of the zebrafish (*Branchydanio rerio*).

The kidney of freshwater fishes is largely dedicated to the production of copious dilute urine and it has little responsibility for ion or acid-base balance. In fish, where they are opposite osmotic gradients, urine flow is severely reduced. In some fish, water loss is further reduced by elimination of glomerular filtration altogether and renal function depends solely on tubular secretion. The kidney of the fish receives the vast majority of post bronchial blood, and because of that, we can expect renal lesions in the fish when toxicant agents exist in the environment. Therefore, a study of these possible kidney changes may be expected to be a good indicator of environmental pollution. In the present study, kidney of the fish showed cloudy swelling in tubule cells. This alteration can be identified by the hypertrophy of the cells and the presence of small granules in the cytoplasm. Initial stage in the degeneration process can progress to hyaline degeneration, characterized by the presence of large eosinophilic granules inside the cells. These granules may be formed inside the cells or by the reabsorption of plasma proteins lost in the urine, indicating damage in the corpuscle (Hinton and Laurén, 1990; Takashima and Hibiya, 1995). In more severe cases, the degenerative process can lead to tissue necrosis (Rajini *et al.*, 2015). The presence of tubule degeneration, coupled with the absence of necrosis in the kidney in the present study indicates that the kidney suffered damage after exposure to sublethal concentration of zinc.

Most common alterations found in the kidney of fishes exposed to water contamination are tubule degeneration (cloudy swelling and hyaline droplets) and changes in the corpuscle, such as dilation of capillaries in the glomerulus and reduction of Bowman's space (Takashima and Hibiya, 1995). Following exposure of fish to toxic agents such pesticides, histological alterations have been found at the level of the tubular epithelium and glomerulus (Teh *et al.*, 1997; Thophon *et al.*, 2003). Similar alterations were found in fishes exposed to organic contaminants (Veiga *et al.*, 2002) and mixed environmental contaminants (Schwaiger *et al.*, 1997; Pacheco and Santos, 2002). The dilation of lumen of the kidney tubules, degeneration in the haemopoietic tissue rupture in the collecting tubules and necrosis into present findings fall in line with chlorpyrifos treatment in various fingerlings (Vardhani and Gowri, 2002). Tilak *et al.* (2005a) reported that, the *Cirrhinus mrigala* was exposed to the sublethal and lethal concentrations of technical grade as well as 20% EC of Chlorpyrifos for 8 days, marked histopathological changes were observed in the fish kidney such as severe necrosis, cloudy swelling in renal tubules, cellular hypertrophy and granular cytoplasm. Ananth and mathivanan (2014) have also reported in the kidney of *Ctenopharyngodonidella* exposed to arsenic trioxide concentration showed an enlargement of intercapsular space with glomerular atrophy, hypertrophy of the kidney tube cells with small granules on its cytoplasm and little nuclear alteration.

Cloudy swelling of renal tubule, marked loss of haemopoietic tissue, shrinkage of glomeruli were reported in *Namachelius denisonii* exposed to phosphamidon (Rashatwar and Ilyas, 1984). Similar observations were made by Csepai (1978) in *Cyprinus carpio* chronically exposed to Anthio 40 EC, Satoxan Basuden 10G, the organochlorine and organophosphate compounds. El-Zalbani and Soliman (1981) and Feng *et al.* (1982) also reported necrosis in renal epithelium, swelling of mitochondria in the renal tubules in animals administered with methothrin and pyrethrin respectively. Such sort of pathological conditions causing disfunction of kidney tissue have been reported under pesticide toxicity by Rama Murthy (1988). Degenerative changes in epithelial cells of proximal tubules and haemopoietic



**Sasikala et al.,**

tissues, severe necrosis in the proximal tubules leading to the formation of vacuoles, degenerative changes in epithelial cells of collecting tubules of *Tilapia mossambica* exposed to fenvalerate has been reported by Radhaiah (1988). The toxic sublethal concentration of fenvalerate technical grade in the kidney of *Cirrhinus mrigala* showed changes in haemopoietic tissue which included severe necrosis, vacuoles around renal tubules and hemorrhage. (Anita Susan and Tilak, 2003) Similar report by Tilak *et al.* (2001c) in kidney tissue of the fish *Ctenopharyngodon idellus* when exposed to technical and sublethal concentration of 20% EC fenvalerate was observed with tissue damage like necrosis, vacuolar degeneration and atrophy.

Histopathological changes in the kidney tissue of the fish *Channa punctata* exposed to sublethal concentration of Butachlor and Machete, an Herbicide was studied and the changes observed were severe necrosis, cloudy swelling, cellular hypertrophy and granular cytoplasm. The distal convoluted tubules decreased in size and formations of vacuoles were reported by Tilak *et al.* (2007). In lindane polluted fish, the kidney showed a disintegration of the convoluted tubules, and large intracytoplasmic vacuoles in the epithelial cells of the tubules. Shrinkage of the glomerulus and increased space within the Bowmans capsule were also observed by Ortiz *et al.*(2003). In *Oryzias latipes* (medaka) exposed to a lindane isomer Wester and Canton (1986), found prominent glomerular hyalinosis as an indicator of renal toxicity. Gupta and Dalela (1987) reported histological changes in kidney of *Notopterus notopterus*, exhibiting degeneration and dissolution of epithelial cells of renal tubules, hypertrophy and necrosis following subtle exposure to phenolic compounds. The present observations are in agreement with the reports of Goel and Veenagarg, (1980); Mandal and Kulshreshtha (1980); Dubale and Awasthi (1982); Malaya Guptha *et al.* (1988); Dhanapakiam and Premilatha (1994); Ramana Kumari (1999); Yacobu (1999); Tilak *et al.* (2001a & 2001b); Tilak *et al.* (2005a&b) Tilak *et al.* (2007) and Prabakaran (2014) who observed renal damage, rupture in the glomeruli, reduced renal tubules and its lumen in different fish exposed to different toxicants. Thus, when fishes are exposed to heavy metal they suffer irreparable architectural changes in various vital organs making the fish less fit for better survival. These histopathological changes can alter various physiological activities of the fish such as release of various enzymes and the metabolic processes. Thus, the histological changes observed in the kidney of the freshwater fish *Branchydanio rerio* exposed to zinc at the concentration of indicate that the fish were responding to the direct effects of the contaminants as much as to the secondary effects caused by stress. Kidney is an important organ of excretion and osmoregulation and it is highly susceptible to toxic substances because of its high blood supply. Kidney plays a major role in the elimination of most of the toxicants and it is considered as a major target organ for toxicity impact (Venkatesan, 2012; Prabakaran, 2014; Ananth and Mathivanan, 2014). Conclusively, pesticides are stored in different sites in animals depending on the metals and on the animal species. To check the continual introduction of these metals in to the food chain, a more cautious application of heavy metals should be employed and effluents from industries must be treated before disposal (Selvanathan *et al.*, 2013).

**REFERENCES**

1. Abbasi, S.A., N. Abbasi and R. Soni 1998. Studies on environmental management of mercury (II), chromium (VI) and zinc (II) with respect to the impact on some arthropods and protozoans – toxicity of zinc (II). International Journal of Environmental Studies, 32: 181- 187.
2. Al-Attar, A.M., 2007. The influences of nickel exposure on selected physiological parameters and gill structure in the teleost fish, *Oreochromis niloticus*. J. Biol. Sci., 7: 77-85.
3. Ananth S, Mathivanan V (2014) Histopathological changes in gill and kidney of *Ctenopharyngodon idella* exposed to arsenic trioxide International Journal of Current Research in Chemistry and Pharmaceutical Sciences (pISSN: 2348-5213; eISSN: 2348-5221).
4. Anita Susan T, Tilak KS (2003) Histopathological changes in the vital tissues of the fish *Cirrhinus mrigala* exposed to fenvalerate Technical grade Poll Res 22(2):179-184.
5. Dubale MS, Awasthi, M (1982) Biochemical changes in the liver and kidney of a cat fish *Heteropneustes fossilis* exposed to Dimethoate Comp. Physiol Ecol 7(2):114.
6. Dhanapakiam, P and Premilatha, J (1994) Histopathological changes in the kidney of *Cyprinus carpio* exposed to Malathion and Sevin. J Environ Biol 15(4): 283-287.





**Sasikala et al.,**

7. El-Zalbani, LM, Soliman AA (1981) Histopathological changes induced by chronic exposure to a household insecticide and experimental study Bull Alexandria Fac Med 17(1): 143-148.
8. Feng, J, Lin, J, Ling, B, Wu, J Xia, X and Zhu, H (1982) Toxicology of methothrin a new insecticide, Jiangsu Yiyao.
9. Gupta AK, Dalela RC (1987) Kidney damage in *Notopterus notopterus* (Pallus) following exposure to phenolic compounds. J Environ Biol 8: 167-172.
10. Goel KA and Veena Garg (1980) Histopathological changes produced in the liver and kidney of *Channa punctatus* after chronic exposure to 2, 3', 4-triaminoazobenzene. Bull Environ Contam Toxicol 25(1): 330-334.
11. Hinton DE, Laurén DJ (1990) Liver structural alterations accompanying chronic toxicity in fishes: potential biomarkers of exposure Pp 51-65 In: McCarthy, JF & LR Shugart (Eds) Biomarkers of Environmental Contamination Boca Raton Lewis Publishers.
12. Iroka, Z., and Drastichova, J., 2004. Biochemical Markers of Aquatic Environment Contamination Cytochrome P450 in Fish. A Review, Acta Vet Brno., 73: 123-132.
13. Kiekens, L. 1995. Zinc, 284-305. In Alloway, B.J. (ed.), Heavy metal in soil, Blakie Academic and Professional, London, Po. 368.
14. Lange M, Gerbauer W, Markl J, Nagel R (1995) Comparison of testing acute toxicity on embryo of zebrafish (*Danio rerio*), and RGT-2 cytotoxicity as possible alternatives to the acute fish test Chemosphere 30/11, 2087-2102.
15. Lehninger, A.L., Nelson, D.L., and M.M.1993. Principles of Biochemistry. Worth Publishers, New York.
16. Livingstone DR (1998) Organic xenobiotics in aquatic ecosystems: quantitative and qualitative differences in biotransformation by invertebrates and fish Comp. Environ Physiol 120: 43-57.
17. Nriagu, J.A.1980. Zinc in the environment. Wiley Interscience, New Year.
18. Malaya Gupta G, Bagiti Sumithra Datta Gupta SN, Dey Sanchayila Mukherjee Archana Roy, Roy DK (1988) Hepatorenal toxicity of Nuvacron and Furadane in mice. Indian J Exp Biol 26: 237-240.
19. Mandal PK Kulshreshtha AK (1980) Histopathological changes induced by sublethal sumithion in *Clarias batracus*. J Biol 18: 547-552.
20. Mondon, J.A., Duda, S., and Nowak, B.F., 2001. Histological, growth and 7- thoxyresorufin O-deethylase (EROD) activity responses of greenback flounder *Rhombosolea tapirina* to contaminated marine sediment and diet. Aquat. Toxicol., 54: 231-247.
21. OECD (2006) Fish Embryo Toxicity Test, Organization for Economic Co-Operation and Development.
22. Oguri, K., Yonekura, H., Nakanishi, Y., Nakazawa, K., Kimura, K., and Okayama, M. Biosynthesis and characterization of sulfated glycoconjugates in chick embryonic cornea. In: T. Yamakawa, T. Osawa. and S. Handa (eds.), Glycoconjugates. pp. 455-456. Tokyo: Japan Scientific Societies Press, 1982.
23. Ortiz JB, De Canales MLG, Sarasquete C (2003) Histopathological changes induced by lindane (gamma-HCH) in various organs of fishes. Sci Mar 67(1): 53–61.
24. Pacheco M, Santos MA (2002) Biotransformation, genotoxic and histopathological effects of environmental contaminants in European eel (*Anguilla anguilla* L) Ecotoxicol Environ Saf 53: 331-347.
25. Prabakaran S, (2004) Hepatoprotective Efficacy of *Pisonia Alba* and *Cardiospermum Halicacabum* and their Antioxidant Potential in the fresh water fish *Labeo Rohita* exposed to atrazine Thesis of Annamalai University.
26. Radhaiah V, (1988) Studies on the toxic impact of a pyrethroid insecticide, fenvalerate on some metabolic aspects and histopathology of a freshwater teleost, *Tilapia mossambica* (Peters) PhD Thesis SV University, Tirupathi, India.
27. Rajini A, Revathy K and Murugan R (2015) Effect of combination pesticide on acetylcholine esterase activity in freshwater fish. Int J Pharm Bio Sci. 6(1): 1305 – 1310.
28. Rama Murthy K, (1988) Impact of heptachlor on haematological-histological and selected biochemical parameters on freshwater edible fish *Channa punctatus* (Bloch) PhD Thesis, SV University, Tirupati, India.
29. Ramana Kumari GV, (1999) Toxicity and effect of chlorpyrifos on Indian major carp *Labeo rohita*, MPhil Dissertation submitted to Nagarjuna University, Guntur, India.
30. Rashatwar S, Ilyas S (1984) Effect of phosphamidon on freshwater teleost fish *Nemachelius densoni*, Histopathological and biochemical studies. J Environ Biol 5, 1.
31. Sasaki, Y.K., Izumiyama, F., Nishidate, E., Ishibashi, S., Tsuda, S., Matsusaka, N., Asano, N., Saotome, K., Sofuni, T. and Hayashi, M. (1997). Detection of xenotoxicity of polluted seawater using shellfish and the alkaline single-cell gel electrophoresis (SCE) assay: A preliminary study. Mutat Res., 393: 133-139.





**Sasikala et al.,**

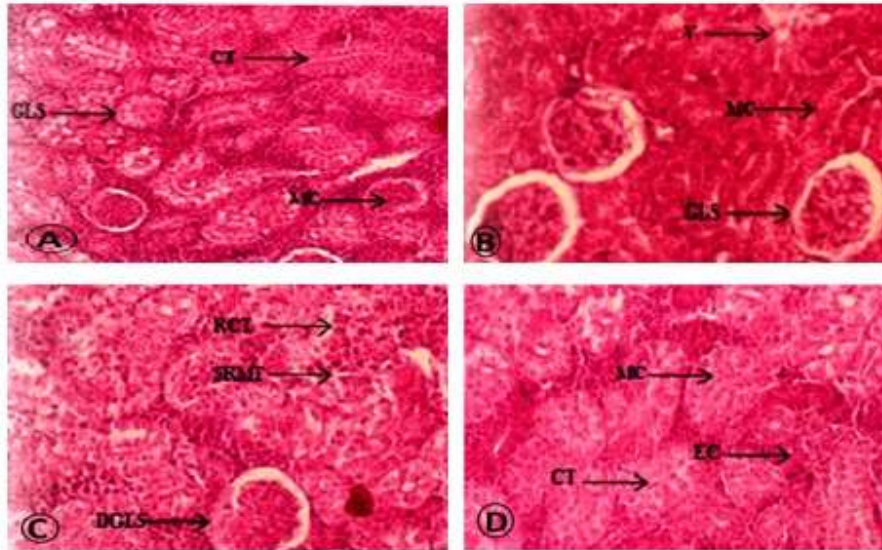
32. Schwaiger J, Wanke R, Adam S, Pawert M, Honnen W, Triebkorn R (1997) The use of histopathological indicators to evaluate contaminant-related stress in fish J Aquat Ecosyst Stres Rec 6: 75-86.
33. Selvanathan.J., S. Vincent and A.Nirmala. (2013). Histopathological changes in fresh water fish *Clarius batrachus* (Linn.) Exposed to mercury and cadmium. International Journal of Life Science and Pharma Research, Vol 3, 2013.
34. Takashima F, Hibya T (1995) An atlas of fish histology: Normal and pathological features, 2nd ed Tokyo, Kodansha Teh SJ, Adams SM, Hinton DE (1997) Histopathological biomarkers in feral freshwater fish populations exposed to different types of contaminant stress Aquatic Toxicology 37: 51-70.
35. Thophon SM, Kruatrachue ES, Upathan P, Pokethitiyook S, Sahaphong S, Jarikhuan (2003) Histopathological alterations of white seabass, *Lates calcarifer* in acute and subchronic cadmium exposure. Environ Poll 121: 307-20.
36. Tilak KS, Veeraiah K, Koteswara Rao D (2005a) Histopathological changes observed in the gill, liver, brain and kidney of the Indian major carp *Cirrhinus mrigala* (Hamilton) exposed to chlorpyrifos. Poll Res 24(1): 101-111.
37. Tilak KS, Veeraiah K, Yacubu K (2001c) Studies on histopathological changes in the gill, liver and kidney of *Ctenopharyngodon idellus* (Valenciennes) exposed to technical fenvalerate and EC 20% Poll Res 20(3):387–393.
38. Tilak KS, Veeraiah K, Thathaji PB (2007) Histopathological changes in the kidney of the fish *Channa punctata* exposed to sublethal concentration of Butachlor and Machete. J Ecotoxicol Environ Monit 17(2): 129-134.
39. Tilak KS, Veeraiah K, Ramana Kumari GV (2001a) Histopathological changes in the gill tissue of the fish *Labeo rohita* (Hamilton) exposed to technical grade and 20% EC chlorpyrifos J Ecotoxicol Environ Monit 11(3): 57-60.
40. Tilak KS, Veeraiah K, Ramana Kumari GV (2001b) Histopathological changes observed in the gill tissue of the fish *Labeo rohita* exposed to chloropyrifos. J Ecotoxicol Environ Monit 11(4):267-270.
41. Tilak KS, Veeraiah K, Koteswara Rao D (2005a) Histopathological changes observed in the gill, liver, brain and kidney of the Indian major carp *Cirrhinus mrigala* (Hamilton) exposed to chlorpyrifos. Poll Res 24(1): 101-111.
42. Tilak KS, Veeraiah K, Thathaji PB (2005b) Histopathological changes in the gill tissue of the fish *Channa punctata* exposed to sublethal concentration of Butachlor and Machete, a herbicide J Aqua Biol 20(1): 111-115.
43. Tong, J.M. and Zhang, W.L. Jixie Gangchang Xuebao (Chin. J. Mech. Eng.) (1994) 30(6), 103-107. International Journal of Fatigue, July 1996.
44. Tucker, B. W., 1997. Overview of current seafood nutritional issues: Formation of potentially toxic products. In F. Shahidi, Y. Jones and D. D. Kitts (Eds.), Seafood safety, processing and biotechnology. Technomic Publishing Co. Inc. 5 – 10.
45. Vardhani VV, Gowri (2002) Antigen induced histopathological changes in liver and kidney of *Leabeo rohita*. J Ecotoxicol Environ Moint, 12(1): 209-213.
46. Veiga, ML, Rodrigues EL, Pacheco FJ, Ranzani-Paiva MJT (2002) Histopathologic changes in the kidney tissue of *Prochilodus lineatus*, 1836 (Characiformes, Prochilodontidae) induced by sublethal concentration of Trichlorfon exposure Brazilian Arch Biol Tech 45: 171-175.
47. Venkatesan, S.; Pugazhendy, K.; Meenambal, M.; Sangeetha, D.; asantharaja, C.V.; Jayachandren, K. and Prabakaran, S. (2012): Protective role of Spirulina on the variation of hematological parameter induced by herbicide Atrazine in the fresh water fish *Cyprinus carpio* (Linn). Int. J. Pharm. Biol. Arch., 3: 249-254.
48. Wester, PW & Canton, JH (1986) Histopathological study of *Oryzias latipes* (medaka) after long term  $\beta$ -hexachlorocyclohexane exposure Aquatic Toxicology 9:21-45.
49. Weideman, M (1993) Toxicity Tests in Animals: Historical Perspectives and New Opportunities Environmental Health Perspectives Volume 101, Number 3, August 1993.
50. World Health Organization (WHO). 1996. Trace elements in human nutrition and health. Geneva, p. 343.
51. Yacubu K (1999) Toxicity of Fenvalerate to the freshwater fish *Ctenopharyngodon idellus* (Valenciennes) M.Phil Dissertation submitted to Nagarjuna University, Guntur, India



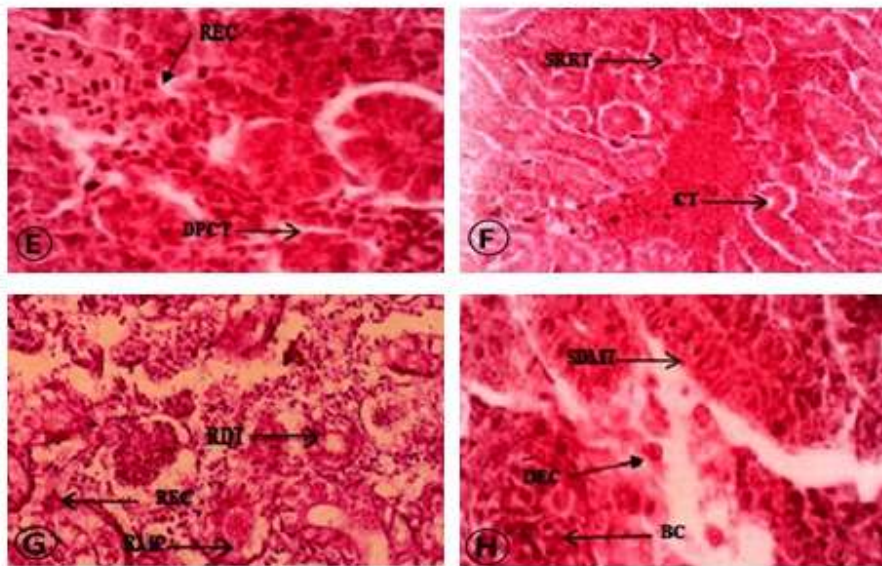


Sasikala et al.,

**CONTROL**



**TREATED**



- CT -Collecting tubules, MC – Mononuclear cells, EC – Epithelial cells, GLS – Glomerules.
- RCT - Rupture of collecting tubules, SRMT – Slight Rupture of malpighian tubules,
- DGLS -Disintegrated Glomerules, RDT - Rupture of distal convoluted tubules,
- RMC - Rupture of mononuclear cells, REC - Rupture of epithelial cells,
- SDMT - Slide damaged of malpighian tubules, BC - Bowman's capsules,
- DEC - Disintegrated epithelial cells, DPCT - Disintegrated proximal convoluted tubules,
- V - Vacuolation.

Fig. 1. Renal tissues of the fish exposed to zinc at the concentration common pathological changes





## Assessment of Water Quality and Plankton Community in Biofloc Shrimp Farm of *Litopenaeus vannamei* (Boone, 1931)

S. Marimuthu and S. Puvaneswari\*

Department of Zoology, Annamalai University, Annamalainagar, Chidambaram, Cuddalore District, Tamil Nadu, India.

Received: 27 Oct 2021

Revised: 15 Nov 2021

Accepted: 25 Nov 2021

### \*Address for Correspondence

**S. Puvaneswari**

Department of Zoology,  
Annamalai University,  
Annamalainagar, Chidambaram,  
Cuddalore District, Tamil Nadu, India.  
Email: Ujar65@gmail.com



This is an Open Access Journal / article distributed under the terms of the **Creative Commons Attribution License** (CC BY-NC-ND 3.0) which permits unrestricted use, distribution, and reproduction in any medium, provided the original work is properly cited. All rights reserved.

### ABSTRACT

Biofloc technology is an eco-friendly aquaculture method established on producing *in-situ* microorganism. Biofloc addresses the suspended growth in ponds or tanks which are the products of living and dead particulate organic matter, planktons, bacteria and grazers of the bacteria. Diversity, distribution and abundance in plankton community and deviation in abiotic characteristics contribute information on energy turnover in the aquatic systems. Therefore in the present investigation, we have decided to identify the various planktons that were developed in the most valuable shrimp species, *Litopenaeus vannamei* cultivated biofloc tank. Periodically collected samples from Normal earthen pond and Biofloc tank were used to estimate the water quality parameters and plankton (phytoplankton and zooplankton) identification and quantitative estimation following standard methods. A significant ( $P < 0.05$ ) seasonal variation was noticed in the studied water quality parameters and density of plankton community between the normal pond and biofloc tank. The water quality parameters studied in both the samples stayed within the proposed range suitable for growing *L.vannamei*. The obtained results supported that biofloc technology with controlled water quality and plankton blooms are more appropriate for the cultivation of shrimp in biofloc farming for an economical purpose.

**Keywords:** Biofloc, *Litopenaeus vannamei*, Water quality parameters, Phytoplankton, Zooplankton



**Marimuthu and Puvaneswari****INTRODUCTION**

Aquaculture and Fisheries is an unique and most expeditious industries in the World (Tacon, 2020) and has been playing a major part in the economical up growth, on account of its support to food and nutritional security, national revenue, employment resources besides bringing forth livelihood opportunities (Kumar and Shivani, 2014). According to Anonymous (2020), it forms the chief source of animal protein for billions of people globally, where capture fisheries and aquaculture contributes the employment opportunities for more than 10% of the citizens worldwide. The support of shrimp farming to worldwide aquaculture production during the last decades ended noteworthy. The production of cultivated prawns and shrimp has increased to 76.6% during the last 10 years (2008–2018), exhibiting 7.3% of global aquaculture production, except aquatic plants. The most important cultivated single crustacean species is the whiteleg shrimp *Litopenaeus vannamei*. The production of this species was nearly doubled up and contributing 53% of total cultivated crustacean production in 2018 (FAO, 2020). The obvious merits of *Litopenaeus vannamei* species, such as adaptability to varying environmental conditions, high density tolerance, and relatively faster growth during shorter culture period (Roy et al., 2010) have provoked it as the most desirable shrimp species for profitable cultivation.

The existing environmental challenges and disease hindrance in the semi-intensive shrimp culture have opened up to intensify the aquaculture aiming to increase the production and face the issues of sustaining adequate aquatic health and growth of shrimp (Panigrahi et al., 2018). The biofloc system is one out of the innovative techniques and is based upon in-situ production of microorganism and an eco-friendly technology presently focused on intensive culture of shrimp (Kumar et al., 2018). The privilege of biofloc systems has been successful to develop water quality, bringing about better nutrition and growth in concentrated shrimp culture. Biofloc systems are extremely productive, and the interactions among physical, chemical and biological characters within these systems are complex (Emerenciano et al., 2017; Khanjani et al., 2020). The term "water quality" reveals the physical, chemical, and biological factors used to determine whether or not water is acceptable to the living being (Neelima and Kumar, 2005). Thus, regular monitoring of water bodies with the required number of parameters not only prevents disease outbreaks and other hazards, but also ensures that the water quality does not deteriorate further (Kakati and Sharma, 2003).

Diversity, distribution and abundance in plankton community and deviation in the biotic characteristics contribute information on energy turnover in the aquatic systems (Gaikwad et al., 2004). Phytoplankton and zooplankton form as a remarkable indicator of environmental conditions and aquatic health. For the maintenance of water quality and sustainable aquaculture, the changes in plankton diversity with seasonal changes in aquatic ecosystem are absolutely needed. The qualitative and quantitative abundance of plankton and its association with environmental status have eventually be a prerequisite for shrimp production. The growth and wane of phytoplankton, the quality and quantity of each species and its diversity depend on abiotic and biotic factors (Komala et al., 2013). Between phytoplankton and other aquatic animals, zooplankton is a major source of energy. They occupy a middle ground in the aquatic food web (Altaff, 2004). The protein rich naturally occurring zooplanktonic organisms are essential to feed the vulnerable larvae, juveniles and even adult of shrimp in nurseries and grow-out pond. The growth and abundance of zooplankton are influenced by a variety of environmental factors that determine the characteristics of water (Thirumala et al., 2007). Studies on water quality parameters and its effects on plankton diversity on biofloc shrimp culture pond are scanty (Casé et al., 2008; Schrader et al., 2011; Saraswathy et al., 2013; Ahsan et al., 2014; Galvez et al., 2015; Martins et al., 2016; Brahmchari et al., 2018; Aditi Rajan Patkar et al., 2021). As a result, the aim of the current study is to determine the water quality parameters, plankton abundance, its diversity and their seasonal variation during the course of whiteleg shrimp *L. Vannamei*, cultured in biofloc tank.







## MATERIALS AND METHODS

### Study area

We selected two *L. vannamei* culture sites - 1). Normal earthen pond (size; L=20m × W=20m × H=1.5m) and 2) Biofloc tank (size: R=5m × H=1.5m) from Thirunagari, near Sirkazhi, Tamil Nadu, India.

### Collection of samples

For water quality parameters and plankton (phytoplankton and zooplankton) identification, water samples were collected periodically during the period from January 2020 to June 2020.

### Assessment of water quality parameters

Throughout the experimental period, water temperature and pH were measured daily at 08:30 to 09:30 AM with a thermometer and pH meter respectively. Water samples were collected from normal pond and biofloc tank every 5 days. Dissolved oxygen (DO), carbon dioxide (CO<sub>2</sub>), alkalinity, salinity, ammonia (NH<sub>3</sub>), nitrite (NO<sub>2</sub><sup>-</sup>), nitrate (NO<sub>3</sub><sup>-</sup>), carbonate(CO<sub>3</sub><sup>2-</sup>), bicarbonate (HCO<sub>3</sub><sup>2-</sup>) and transparency (Secchi disk) were determined following the standard methods of APHA (2017).

### Plankton identification

For plankton (phytoplankton and zooplankton) identification, water samples were collected periodically during the period from January 2020 to June 2020 from the selected sites. The water samples were collected fortnightly around 9.00 to 11.00am with the help of plankton net, mesh size 200-300μ meter made by bolting silk cloth. The collected water samples were fixed with 20 ml of Lugol's iodine solution and kept for 24 hours for sedimentation. The supernatant was decanted, retaining 100 ml of the sample for morphological identification and quantitative analysis of planktons. The samples were preserved in 4% buffered formalin for further morphological identification and quantitative estimation of planktons. Preserved samples in bottles were mixed uniformly by gentle inversion and then one drop of the sample was pipetted out from a calibrated pipette onto counting chamber for analysis. An advanced microscope Nikon 80i was used to identify the planktons with different eyepieces such as 10X and 40X. Identification of planktons up to genus level was done by referring standard manuals (Serediak and Huynh, 2011; Bellinges and Sigee, 2015; Phan Doan Dang et al., 2015; Manickam et al., 2019).

### Quantitative estimation of planktons

Quantitative estimation of plankton was done by numerical method using Sedgwick Rafter counting cell and observed values are expressed in terms of organisms per liter using the following formula (APHA, 1998).

$$\text{Density (Cells /lit)} = \frac{C \times A_t}{A_s \times S \times V} \times \frac{\text{Volume of concentrated sample (ml)}}{\text{Volume of actual water filtered (ml)}}$$

Where, C = Number of organisms counted; A<sub>t</sub> = Area of cover slip (22 mm × 22 mm); S = Number of strip counted; A<sub>s</sub> = Area of strip (22 mm × 1 mm); V = Volume of sample under the cover slip

### Statistical analysis

All statistical analyses were performed with SPSS17.0 software. The differences in water quality and the abundance of plankton were considered significant when P < 0.05. One way ANOVA was used to determine the significance of each parameter among normal pond and biofloc tank.





## RESULTS AND DISCUSSION

### Water quality Parameters

The water suitability accompanied with aquaculture developments is a primary concern worldwide and deals with a variety of negative environmental impacts on the receiving environment have been acknowledged (Lacerda et al., 2006). It plays an essential role in increasing the total productivity of shrimp farm and provides nutritionally stable and sustainable environment to cultured animals. Naturally, the assessment of water quality results in a combination of physical variables and biological indicators (Jones et al., 2001). Poor water quality decreases the shrimp growth rate and increases the mortality rate due to fluctuations in the ecosystem dynamics (Edhy et al., 2010). The results of all studied water quality characters like temperature, pH, dissolved oxygen, carbon dioxide, salinity, alkalinity, ammonia, nitrate, nitrite, carbonate, bicarbonate and transparency were presented in Table 1. All the water quality characters studied in normal pond and biofloc tank remained within the limits of optimal range suitable for the growth of *L. Vannamei* (Table 1).

During the experimental period, water temperature in both normal pond and biofloc tank was maintained between 26-32 °C. Shrimp are commonly cultivated in enclosed, shallow ponds with low levels of water exchange in addition to tropical climatic conditions allowed for significant seasonal and diurnal variations in water temperature to occur. The most commonly farmed penaeid shrimp *L. vannamei*, is able to tolerate wide variations in temperature, ranging from 7.5 to 42.0°C and above 12°C is advisable for shrimp culture farms (Kumlu et al., 2010). The ideal temperature for growth of this species is reported to depend on its size (Wyban et al., 1995). Temperature influences the oxygen consumption, metabolism, moult cycle, immune response, growth and survival and disease outbreak of the crustacean (Guan et al., 2003; Cheng et al., 2005; Allan et al., 2006; Hargreaves, 2013). In general, water temperature in the range from 25 to 30°C is appropriate for ideal growth of shrimp (Bett and Vinatea, 2009). In the present study, water temperature remained under optimum range. Temperature has the most remarkable biological impact on the activities of the flora and fauna of the aquatic farm. Plankton growth and diversity may be controlled by changes in water temperature and seasonal temperature.

The pH was found to be 8 in biofloc tank during both the seasons and no significant ( $P < 0.05$ ) seasonal variation was noticed. The pH of both normal and biofloc tank was found to be alkaline in both the seasons (Table 1 and Figs.1 and 2). According to Mridula et al. (2003), the slightly alkaline based substrate tank provided the favourable conditions for plankton growth. In our study also we have noticed high plankton productivity in normal pond and biofloc tank. Reddy and Mounika (2018) stated that the optimal pH value for *L.vannamei* shrimp culture is 7.5–8.5, with a fluctuation range of 0.5. Significantly low or high pH stresses the shrimp and leads to soft shell formation and poor survival rate. The range of pH in our study is suitable for optimal growth of *L.vannamei* (Boyd, 1990). The content of DO during day time was observed as 6.3 in normal pond and 6.9 in biofloc tank and at the same time, and during night it was observed as 4.8 and 5.0 respectively. A significant variation ( $P < 0.05$ ) in DO content was noticed between normal pond and biofloc tank. The highest point of DO level was recorded during day time being the peak time of photosynthesis, which highly promotes oxygen saturation (McGraw et al., 2001). Moreover, the fluctuation in the present study was also influenced by the use of paddlewheels in normal pond and nonstop usage of ring blower in biofloc tank. Furthermore, this is also strongly influenced by water exchange, temperature, salinity, algal growth, organism respiration and the level of decomposition of organic matter by micro organisms (Li et al., 2013). The fluctuations of DO will provide an overall dynamic effect on the pond ecosystem; accordingly, it is always desirable to keep the status of biotic and abiotic factors stable in a pond to maintain the balance of the ecosystem (Edhy et al., 2010).

In addition, shrimp culture demands maintaining the DO level above 4.5 mgL<sup>-1</sup> (Simbeye and Yang, 2014), while the optimum value in *L.vannamei* shrimp farming ranges between 4–5 mgL<sup>-1</sup> (Islam et al., 2004), being influenced by the salinity level, shrimp weight and stocking density (Vinatea et al., 2011). This optimum value is highly important in the dynamics of pond water quality and a vital parameter for aerobic respiration and oxidation-reduction process in



**Marimuthu and Puvaneswari**

water (Boyd, 2000). In our present study, no significant ( $P < 0.05$ ) seasonal variation was noticed in  $\text{CO}_2$  level of biofloc tank. The level of  $\text{CO}_2$  was found to be within the optimal range for *L.vannamei* culture. All organisms releases  $\text{CO}_2$  continuously through respiration, such that the rate of  $\text{CO}_2$  production depends on the density of organisms and the rate of  $\text{CO}_2$  consumption based upon phytoplankton mass. In this present study, phytoplankton density was found to be more in two samples. Warmer temperatures may stimulate microbial activity resulting in higher  $\text{CO}_2$  level from decomposition (Paramasivam and Kannan, 2005). In this study, the temperature and pH values were also within the optimal range.  $\text{CO}_2$  is acidic in nature and it declines the pH of water. Furthermore, at lower pH,  $\text{CO}_2$  becomes the chief form of carbon and the level of carbonate and bicarbonate would decrease.

Salinity of both the samples was found to be 2 ‰ and no significant seasonal variation was noticed. Salinity plays a prime role in the growth of cultured shrimp through osmoregulations of body minerals from that of the nearby surrounding water source. The early life stages as well as the adult of *L.vannamei* can grow well in freshwater. Nevertheless, for better growth and survival, optimum range of salinity should be sustained in the shrimp farm. The shrimp are able to naturally grow between 0 and 40 ‰, due to the fact that shrimp possess an osmose hemolymph metabolism system (Maica et al., 2014). A significant seasonal variation ( $P < 0.05$ ) in alkalinity was noticed between samples. Alkalinity of an aquatic ecosystem partly relies on the amount of water existing in it. A decline in the level of bicarbonate concentration may happen over the course of the rainy season in relatively shallow bodies of water. The high bicarbonate alkalinity in winter was likely due to the low temperature, low free carbon dioxide and rainfall. In normal pond and biofloc tank, the low alkalinity was observed during summer which is similar with the results of George (1964).

According to Boyd (1982), in fertilized ponds the total alkalinity should be more than  $20 \text{ mgL}^{-1}$  and total alkalinity in this present study was recorded as  $160\text{-}176 \text{ mgL}^{-1}$  which seems that the ponds are more productive. In terms of photosynthesis and oxygen production, water with higher alkalinity is regarded as more productive. Higher nutrient turnover rate and productivity was recorded in the substrate ponds with high alkalinity (Gangadhar et al., 2012). The recorded values of carbonate and bicarbonate showed significant seasonal variations ( $P < 0.05$ ) between the samples. The amount of carbonate and bicarbonate ions indicates the total alkalinity of the water. Alkalinity plays a significant role in shrimp culture systems due to its role in the shrimp molting process. Low alkalinity ends in pH fluctuations which results in reduced growth rate and even death in shrimp. High alkalinity levels may terminate the process of molting in shrimp through excess salt loss. It also indirectly affects the primary productivity of the pond (Venkateswarlu et al., 2019). The excess amount of carbonate ( $> 33 \text{ mgL}^{-1}$ ) may produce hard exoskeleton and leads to molting problems.

The levels of ammonia, nitrate and nitrite were found to be  $0 \text{ mgL}^{-1}$  during summer and winter seasons in both samples. The levels of these nitrogenous compounds can be toxic; however, these levels were maintained not beyond the limits of safety as stated by Lin and Chen (2001, 2003) during the study periods. In our study, these values were maintained with the help of aerators and periodical addition of carbon sources and probiotics. The amount of nitrogenous compounds in an enclosed pond ecosystem frequently over reach naturally occurring levels (Ferreira et al., 2011) by degradation of leftover feed and metabolic wastes defecated by culture shrimp (Nhan et al., 2006). In general, the toxicity of these compounds varies based on the developmental stage of crustaceans. A significant tolerance to the toxicity of nitrogenous compounds was noticed between larval and juvenile stages (Romano and Zeng, 2007; Kuhn et al., 2010).

Increased levels of nitrogenous compounds resulted in physiological effects like reduced feed intake, reduced growth rates even with increased moult frequency and retarded development (Chen and Chen, 1992; Kuhn et al., 2010), and pathological changes in gills structure and functions in penaeid shrimp (Romano and Zeng, 2007; Kuhn et al., 2010). The high nitrite levels accompanied by acidic pH conditions also resulted in reduced nutrient intake, reduced oxyhemocyanin content and reduced immune response (Ramirez-Rochin et al 2017; Bardera et al., 2019). The transparency of normal pond and biofloc tank during winter season was 40 cm and 38 cm; and summer was 39 cm and 36 cm respectively (Tables 1 and figs. 1 and 2). A significant seasonal variation was noticed between the



**Marimuthu and Puvaneswari**

samples. These values were within the optimal range for *L.vannamei* culture (Boyd, 1990). Transparency in biofloc tank was less than that of normal pond as reported by Azim et al. (2003). They have also indicated the inverse relationship between periphyton growth and water transparency.

**Plankton community**

Phytoplanktons are natural flora in shrimp aquaculture ponds and their quantities and their diversity was kept in check by both abiotic and biotic factors. Phytoplankton balance the whole pond environment by decreasing the wide variations in water quality and prevention of enhanced waste nutrients to noxious levels thus assuring better shrimp growth and yields (Lemonnier et al., 2017). Case´ et al. (2008) stated that, the Phytoplankton is highly sensitive when the changes occur in the water quality of aquaculture systems, accordingly serves as an excellent bio-indicator of environmental conditions. It has been noticed that, the phytoplankton production is a rich source of food for the zooplanktonic communities and these produce nutrients for bacterial growth and formation of flocs in a biofloc system with enough light. In shrimp culture ponds, phytoplankton was noticed to be growing naturally and their quality, quantity and diversity often vary, depending on several environmental factors (De Castro Araújo and Garcia, 2005).

The plankton density (phytoplankton and zooplankton) was significantly higher ( $P < 0.05$ ) in normal pond than biofloc tank during winter and summer seasons (table 2 and Figs. 3, 4, 5 and 6). But, when considering the size of the two study areas the density of plankton was more in biofloc tank than normal pond. A significant seasonal variation in plankton community was noticed between normal pond and biofloc tank. This finding was in confirmation with the reports of Saraswathy et al. (2013). The quantity of plankton was more during summer than winter in both the samples. It showed that variation in plankton densities was influenced by water quality parameters (Pulle and Khan, 2003).

During summer and winter seasons, a total of 19 different species of phytoplankton belonging to four different classes including Chlorophyceae, Diatoms, Micro algae and Cyanophyceae were observed (Table 2 and plate 1). Though all the three classes were present in both the samples, plankton abundance was higher in summer than winter. It might be due to changes in water quality parameters. Based on the density, the most dominant group of phytoplankton was Chlorophyceae followed by Diatoms, micro algae and Cyanophyceae in both the samples during summer and winter seasons respectively. In our present study, the green algae were the predominant group of phytoplankton in both normal pond and biofloc tank. This finding is in concurrence with the findings of Schrader et al. (2011). They have also observed more chlorophytes in biofloc shrimp culture pond. They are a favoured group since they eliminate ammonium (Chen 2001), and improve the survival and yield in shrimp (Ge et al., 2016). Ju et al. (2008), Maicá et al. (2012) have also noticed the chlorophytes dominated at low salinities (2-4) in biofloc systems as our reports. The salinity in our study area was also found to be 2 ‰.

Euglena was found to be a major group in both the samples during winter as well as the summer season as reported by Marinho et al. (2016). They have also reported that the Euglenophytes are one of the major groups in most biofloc systems. This group adapts for a wide spectrum of salinity and they have been found in large quantity in studies with freshwater (Schrader et al., 2011) or low salinity waters (Ju et al., 2008). As Euglena is rich in protein and nutritional value; it is used as feed for livestock and aqua farm fish. In the present study, the algae from different groups (green algae, micro algae and blue green algae) were noticed. This confirms with the studies of Galvez (2015) and Schrader et al. (2011). They have also identified the most abundant algae in biofloc shrimp culture systems. The nutritional value of microalgae plays an important role which is dependent on its size and shape, digestive nature, biochemical composition, and bioactive compounds such as enzymes, vitamins, antioxidants, etc. (Emerenciano et al., 2017).

In freshwater aquaculture, the green algae, *Selenastrum* are being used as the source of food for zooplankton. For ecosystem health, these organisms are the valuable bio-indicator, and many species of this family are used as indicator species to assess the levels of nutrients or toxins in freshwater environments. *Scenedesmus*, has the efficiency



**Marimuthu and Puvaneswari**

of removing ammonia and phosphorus from the wastewater to the same extent and for bacterial breakdown of organic matter it provides oxygen and thereby destroys other harmful substances. This species indicates the presence of toxins and can heed the researchers of subtle changes in water quality before a problem gets aggravated. In our present study, Diatoms were noticed as a second major group in both the culture system during winter and summer seasons (table 2 and Figs. 3 and 4). In agreement with our results Martins et al. (2016) have also observed the Diatoms in biofloc cultured system with low salinity. We have also recorded low salinity in our study areas. Similar to our results, Schrader et al. (2011), Godoy et al. (2012), Martins et al. (2016) have also recorded the diatom predominance in biofloc shrimp culture system. To intensify the contents of highly unsaturated fatty acids and essential amino acids in shrimp tissues, the presence of Diatoms is highly required because of their nutritional value and their composition increase shrimp production (Godoy et al., 2012; Martins et al., 2016).

Cyanobacteria and chlorophytes were found in normal as well as in biofloc tank during the study period as reported by Martins et al. (2016). They have stated that these groups are usually observed in *L. vannamei* biofloc systems. Cyanobacteria use carboxysome, a cage-like structure for concentrating CO<sub>2</sub> and therefore increase the efficiency of *RuBisCo*, the CO<sub>2</sub>-fixing enzyme. Cyanobacteria (*Anabaena*) are capable of nitrogen fixation through heterocysts cells by producing the enzyme *nitrogenise*; the other organisms can readily use this nitrogen and convert into proteins and nucleic acids. Conversely, as the nutritional value is low in cyanobacteria, it imparts noxious blooms, unpleasant flavors to cultured animals and affects water quality (Ju et al., 2008; Schrader et al., 2011). But in our present study these are the least group among the identified phytoplankton groups in normal and biofloc system. The phytoplankton growth in intensive shrimp pond could be from the unutilised feed and metabolic waste (Keawtawee et al., 2012).

Zooplankton forms the first source of exogenous nutrition for larval fish (Mills et al., 1986). Also, abundance of zooplankton depends not only on phytoplankton availability, but depends on other ecological parameters also. In aquatic system, the density of zooplankton determines productivity. Coman et al. (2003) stated that, the complex assemblages of zooplankton and epibenthic fauna in shrimp ponds provided nutrition to the post larvae of shrimp. The main factors for these changes are variations in source of food, predation and water quality parameters. Zooplanktons are used as the indices worthwhile in indicating the water quality for the shrimp culture. This was due to the fairly distinct patterns in the species composition and abundance, as the water quality changed spatially and temporally. This may be due to the fact that the zooplankton community itself responds directly or indirectly to changes in the physicochemical variables and the availability of phytoplankton food.

In our present study, the dominant group of zooplankton was Brachionus, followed by Cyclopid, Daphnia, Chydorus and Cyclidium during summer than winter in both samples (Table 2 and Figs.5 and 6). Brachionus was the most dominant group in both the samples and this finding was supported by the reports of Galvez et al. (2015). They have noticed that the Rotifers were the predominant zooplankton in the biofloc tanks along with copepods, protozoans and cladocerans. Brachionus are mainly used as live food organisms in aqua hatcheries. It serves as an ideal starter diet for early larval stages of many fish and prawn species in marine as well as freshwater and improved significantly the growth rate of prawn larvae. They are also the most efficient rotifers in the process of phosphorus remineralisation. *Daphnia*, a small crustacean, popular live food for shrimp farms contains comprehensive digestive enzymes that can serve as exo-enzymes in the gut of shrimp larvae.

In the whole study period, sustainability was seen in zooplankton production and this could be due to the periodical addition of nutrients and biofloc development in normal and biofloc tank. The zooplankton production was found to be high in biofloc tank than that of normal pond. The zooplankton production in biofloc is higher and may be due to higher periphyton density on biofloc that might be served as food for zooplankton. The same results were obtained by Ahsan et al. (2014), Brahmchari et al. (2018). In the quantitative analysis of zooplankton, rotifera and crustacean were the most essentially found organisms in normal pond and biofloc tank. In open environmental cultures, it has been observed that with adequate light, there is an increase in the quantity of phytoplankton, which nourishes the zooplanktonic communities which in turn produce nutrients for bacterial growth and formation of flocs



**Marimuthu and Puvaneswari**

in the Biofloc system. Zooplankton consumption that are in flocs from shrimp culture, have greater benefits like a higher growth rate, increased feed conversion ratio, and decrease in the balanced commercial feed cost (Hargreaves, 2013). This is in agreement with Porchas Cornejo et al. (2012), they have noticed better growth rate that shrimp *L. Vannamei*, when they consumed higher amount of natural food in the culture pond. Martinez-Cordova et al. (2002) stressed that the zooplankton was an important alimentary source for shrimp in the first phase of the culture period.

**CONCLUSION**

The fitfulness of phytoplankton with the seasonal changes in aquatic environment is greatly needed for the maintenance of water quality and sustainable aquaculture. A flourishing phytoplankton can reduce toxic substances since phytoplankton can deplete ammonia-nitrogen and tie-up heavy metals. Zooplankton serves as food to phytoplankton and larval stages and adult of shrimp. Thus, the qualitative and quantitative plentitude of plankton in relation to environmental conditions are imperative for shrimp *L.vannamei* production.

**ACKNOWLEDGMENT**

We are thankful to the authorities of Annamalai University for providing the necessary facilities to carry out this work.

**REFERENCES**

1. Aditi Rajan Patkar., Manjappa, N. and Harsha Nayak.(2021). Dynamics of plankton in substrate based fish and prawn culture. J Entomol Zool Stud. 9(3):175-182.
2. Ahsan, M.E., Sharker, M.R., Alam, M.A., Siddik, B. and Nahar A. (2014). Effects of addition of tilapia and periphyton Substrates on water quality and abundance of plankton in freshwater prawn culture ponds. International J Scientific Technology Research. 3(2):272-278.
3. Allan, E.L., Froneman, P.W. and Hodgson, A.N. (2006). Effects of temperature and salinity on the standard metabolic rate (SMR) of the caridean shrimp *Palaemon peringueyi*. J. Exp. Mar. Biol. Ecol. 337, 103–108.
4. Altaff K. (2004). A manual of zooplankton. University grants commission, New Delhi.
5. Anonymous. (2020). The State of World Fisheries and Aquaculture. Sustainability in action. FAO, Rome, Italy. 244.
6. APHA (American Public Health Association).(1998). American Water Works Association, Water Pollution Control Federation. Standard Methods for the Examination of Water and Wastewater, 20th ed., Washington, DC, USA.
7. APHA. (2017). Standard Methods for Examination of water and waste water, American Public Health Association. Washington, DC.
8. Azim, M.E., Verdegem, M.C.J., Mantingh, I., Van Dam, A.A., and Beveridge, M.C.M.(2003). Ingestion and utilization of periphyton grown on artificial substrates by Nile Tilapia, *Oreochromis niloticus* L., Aquaculture Research.34:85-92.
9. Bardera, G., Owen, M. A., Pountney, D., Alexander, M. E. and Sloman, K. A. (2019). The effect of short-term feed-deprivation and moult status on feeding behaviour of the Pacific white shrimp (*Litopenaeus vannamei*). Aquaculture. 511, 734222.
10. Bellinger, E.G. and Sigee, D.C. (2015). Freshwater Algae: Identification, Enumeration and Use as Bioindicators. Second Edition, John Wiley & Sons, Ltd, UK.
11. Bett, C. and Vinatea, L. (2009). Combined effect of body weight, temperature and salinity on shrimp *Litopenaeus vannamei* oxygen consumption rate. Braz. J. Oceanogr. 57 (4): 305–314.
12. Boyd C. E. (2000). Water quality - an introduction. Springer Science+Business Media. New York, 330 p.





### Marimuthu and Puvaneswari

13. Boyd, C. E., (1990). Water Quality in Ponds for Aquaculture. Alabama Agricultural Experiment Station, Auburn University. Alabama.
14. Boyd, CE. (1982). Water Quality Management for Pond Fish Culture. Elsevier. New York. 318.
15. Brahmchari, R.K., Kumar, S. and Singh, M. (2018). Interplay of Substrate Variation and Biofilm Formation in Augmenting Carp Production. International J of Current Microbiology and Applied Science. 7:3774-3786.
16. Case, M., Leca, E.E., Leitao, S.N., Sant'Anna, E.E., Schwamborn, R. and Junior ATD. (2008). Plankton community as an indicator of water quality in tropical shrimp culture ponds. Marine Pollution Bulletin. 56:1343-1352.
17. Chen, Y. L. L. and Chen, H. Y. (1992). Juvenile *Penaeus monodon* as effective zooplankton predators. Aquaculture. 103(1): 35-44.
18. Chen, Y.C. (2001). Immobilized microalga *Scenedesmus quadricauda* (Chlorophyta, Chlorococcales) for long-term storage and for application for water quality control in fish culture. Aquaculture. 195:71–80.
19. Cheng, W., Wang, L.U. and Chen, J.C. (2005). Effect of water temperature on the immune response of white shrimp *Litopenaeus vannamei* to *Vibrio alginolyticus*. Aquaculture. 250: 592–601.
20. Coman, F.E., Connolly, R.M. and Preston, N.P. (2003). Zooplankton and epibenthic fauna in shrimp ponds: factors influencing assemblages dynamics. Aquaculture Research. 34: 359–371.
21. De Castro Araújo, S. and Garcia, V. M. T. (2005). Growth and biochemical composition of the diatom *Chaetoceros cf. wighamii* brightwell under different temperature, salinity and carbon dioxide levels. I. Protein, carbohydrates and lipids. Aquaculture. 246(1-4): 405-412.
22. Edhy, W. A., Azhary, K., Pribadi, J. and Chaerudin, M. (2010). White shrimp culture (*Litopenaeus vannamei* Boone, 1931). C. V. Mulia Indah, Jakarta. 194 p.in Indonesian.
23. Emerenciano, C.M.G., Martínez-Córdova, L.R., Martínez-Porchas, M. and Miranda-Baeza, A. (2017). Biofloc Technology (BFT): A Tool for Water Quality Management in Aquaculture. Intech.
24. FAO (Food and Agriculture Organization of the United Nations). (2020). Global Aquaculture Production. 1950–2018.
25. Ferreira, N. C., Bonetti, C. and Seiffert, W. Q. (2011). Hydrological and water quality indices as management tools in marine shrimp culture. Aquaculture. 318(3-4): 425-433.
26. Gaikwad, S.R., Tarot, S.R., and Chavan, T.P. (2004). Diversity of Phytoplankton and Zooplankton with respect to pollution status of river Tapi in North Maharashtra region. Journal of Current Science. 5:749-754.
27. Galvez, A.O., Figueiredo, C.V., da Silva, C., Marinho, Y.F., Vinatea, L. and Brito, L.O. (2015). Plankton communities in shrimp monoculture, integrated biofloc system. Missouri, USA: Global Aquaculture Advocate Magazine. 18(3):36-38.
28. Gangadhar, B. and Keshavanath, P. (2012). Growth performance of rohu, *Labeo rohita* (Ham.) in tanks provided with different levels of sugarcane bagasse as periphyton substrate. Indian Journal of Fisheries. 59:77-82.
29. Ge, H., Li, J., Chang, Z., Chen, P., Shen, M. and Zhao F. (2016). Effect of microalgae with semi continuous harvesting on water quality and zootechnical performance of white shrimp reared in the zero water exchange system. Aquac Eng. 72–73:70–76.
30. George, M.G. (1964). Comparative plankton ecology of five fish tanks in Delhi, India Hydrobiol. 27:81-108.
31. Godoy, L.C., Odebrecht, C., Ballester, E., Martins, T.G. and Wasielesky, W.J. (2012). Effect of diatom supplementation during the nursery rearing of *Litopenaeus vannamei* (Boone, 1931) in a heterotrophic culture system. Aquac Int. 20:559–569.
32. Guan, Y., Yu, Z. and Li, C. (2003). The effects of temperature on white spot syndrome infections in *Marsupenaeus japonicus*. J. Invertebr. Pathol. 83: 257–260.
33. Hargreaves, J.A. (2013). Biofloc production systems for aquaculture. Southern Regional Aquaculture Center. Missisipi. EU, 4503.
34. Islam, M.S., Kamal, A.H.M.M., Wahab, M.A. and Dewan S. (2004). Water quality parameters of coastal shrimp farms from southwest and southeast regions of Bangladesh. Bangladesh Journal of Fisheries Research. 8(1):53-60.
35. Jones, A.B., Jones, M.J., ODonohue, J. and Denninson, W.C. (2001). Assessing ecological impacts of shrimp and sewage effluent: biological indicators with Standard water quality analysis. Estuarine, Coastal and Shelf Science. 52:91–109





### Marimuthu and Puvaneswari

36. Ju, Z.Y., Forster, I., Conquest, L., Dominy, W., Kuo, W.C. and Horgen, F.D. (2008). Determination of microbial community structures of shrimp floc cultures by biomarkers and analysis of floc amino acid profiles. *Aquaculture Research*. 39:118–133.
37. Kakati, S.S. and Sharma, H.P. (2003). Studies on water quality index of drinking water of Lakhimpur District, Indian J. Env. Prot. 27 (5): 425-428.
38. Keawtawee, T., Fukami, F., Songsangjinda, P. and Muangyao, P. (2012). Nutrient, phytoplankton and harmful algal blooms in the shrimp culture ponds in Thailand. *Kuroshio Sci* 5: 129–136.
39. Khanjani, M.H., Alizadeh, M. and Sharifinia, M. (2020). Rearing of the Pacific white shrimp, *Litopenaeus vannamei* in a biofloc system: The effects of different food sources and salinity levels. *Aquaculture Nutrition*. 26: 328–337.
40. Komala, H.P., Nanjundaswamy, L. and Devi Prasad, A.G. (2013). An assessment of Plankton diversity and abundance of Arkavathi River with reference to pollution. *Advances in Applied Science Research*. 4(2): 320-324.
41. Kuhn, D.D., G.J. Flick. and A.L. Lawrence. (2010). Biofloc: Novel sustainable ingredient for shrimp feed. *Global Aquaculture Advocate*. 71-72.
42. Kumar, S.T. and Shivani, P. (2014). Marine fisheries; its current status, sustainable management and socio-economic status of the marine fishers of Odisha, through Indian Marine Policy: A case study. *Research Journal of Animal, Veterinary and Fishery Sciences*. 2(7):10–19.
43. Kumar, V.S., Pandey, P.K., Anand, T., Bhuvaneshwari, G.R., Dhinakaran, A. and Kumar, S. (2018). Biofloc improves water, effluent quality and growth parameters of *Penaeus vannamei* in an intensive culture system. *J. Environ. Manag.* 215:206–215.
44. Kumlu, M., Kumlu, M. and Turkmen, S. (2010). Combined effects of temperature and salinity on critical thermal minima of pacific white shrimp *Litopenaeus vannamei* (Crustacea: Penaeidae). *Journal of Thermal Biology*. 35(6):302-304.
45. Lacerda, L.D., Vaisman, A.G., Maia, L.P., Silva, C.A.R. and Cunha, E.M.S. (2006). Relative importance of nitrogen and phosphorus emissions from shrimp farming and other anthropogenic sources for six estuaries along the NE Brazilian coast. *Aquaculture*. 253: 433–446.
46. Lemonnier, H., Hochard, S., Nakagawa, K., Courties, C. and Rodier, M. (2017). Response of phytoplankton to organic enrichment and shrimp activity in tropical aquaculture ponds: a mesocosm study. *Aquatic Microbial Ecology*. 80(2):105-122.
47. Li, H., Liu, L., Li, M. and Zhang, X. (2013). Effects of pH, temperature, dissolved oxygen, and flow rate on phosphorus release processes at the sediment and water interface in storm sewer. *Journal of Analytical Methods in Chemistry*. 104316, 7 p.
48. Lin, Y.C. and Chen, J.C. (2001). Acute toxicity of ammonia on *Litopenaeus vannamei* (Boone) juveniles at different salinity levels. *J Exp Mar Biol Ecol*. 259:109–119.
49. Lin, Y.C. And Chen, J.C. (2003). Acute toxicity of nitrite on *Litopenaeus vannamei* (Boone) juveniles at different salinity levels. *Aquaculture*. 224:93–201.
50. Maica, P. F., de Borba, M. R., Martins, T. G. and Junior W. W. (2014). Effect of salinity on performance and body composition of Pacific white shrimp juveniles reared in a super-intensive system. *Revista Brasileira de Zootecnia*. 43(7):343-350.
51. Manickam, N., Santhanam, P. and Saravana Bhavan, P. (2019). Techniques in the Collection, Preservation and Morphological Identification of Freshwater Zooplankton. In: Santhanam P., Begum A., Pachiappan P. (eds) *Basic and Applied Zooplankton Biology*. ISBN : 978-981-10-7952-8, Springer, Singapore.
52. Marinho, Y.F., Brito, L.O., Campos, S., Severi, W., Andrade, HA. and Galvez, AO. (2016). Effect of the addition of *Chaetoceros calcitrans*, *Navicula* sp. and *Phaeodactylum tricornutum* (diatoms) on phytoplankton composition and growth of *Litopenaeus vannamei* (Boone) postlarvae reared in a biofloc system. *Aquac Res*. 48:4155–4164.
53. Martínez-Córdova, L., Campaña-Torres, A., and Porchas-Cornejo, M. (2002). Promotion and contribution of biota in low water exchange ponds farming blue shrimp, *Litopenaeus stylirostris* (Stimpson). *Aquac Res*. 33:27-32.
54. Martins, T.G., Odebrecht, C., Jensen, L.V., D'Oca, M.G. and Wasielesky, WJ. (2016). The contribution of diatoms to bioflocs lipid content and the performance of juvenile *Litopenaeus vannamei* (Boone, 1931) in a BFT culture system. *Aquac Res*. 47:1315–1326.







### Marimuthu and Puvaneswari

55. McGraw, W., Coddington, D. R. T., Rouse, D. B. and Boyd, C. E. (2001). Higher minimum dissolved oxygen concentrations increase penaeid shrimp yields in earthen ponds. *Aquaculture*. 199:311-321.
56. Mills, E.L., Mcqueen, D.J. and Post, J.R.(1986). Trophic relationships in freshwater pelagic ecosystems. *Canadian Journal of Fisheries and Aquatic science*. 43:1571-1581.
57. Mridula, R. M., Manissery, J. K., Keshavanath, P., Shankar, K. M., Nandeesh, M. C. and Rajesh, K. M., (2003). Water quality, biofilm production and growth of fringe-lipped carp (*Labeo fimbriatus*) in tanks provided with two solid substrates. *Bioresow: Technol.*, 87:263-267.
58. Neelima, R. and Kumar. (2005). *Water: Characteristics and properties*. A.P.H. Publishing corporation, New Delhi. Pp 1-346.
59. Nhan, D. K., Milstein, A., Verdegem, M. C. and Verreth, J. A. (2006). Food inputs, water quality and nutrient accumulation in integrated pond systems: a multivariate approach. *Aquaculture*. 261(1): 160-173.
60. Panigrahi, A., Saranya, C., Sundaram, M., Kannan, S.V., Das R.R. and Kumar R.S. (2018). Carbon: Nitrogen (C: N) ratio level variation influences microbial community of the system and growth as well as immunity of shrimp (*Litopenaeus vannamei*) in biofloc based culture system. *Fish & Shellfish Immunology*. 81: 329–337.
61. Paramasivam, S. and L. Kannan. (2005). Physicochemical characteristic of muthupetta mangrove environment southeast coast of india. *Int.J.Ecol.Enviro.Sci*.31:273-278.
62. Phan Doan Dang., Nguyen Van Khoi., Le Thi Nguyet Nga., Dang Ngoc Thanh. and Ho Thanh Hai. (2015). *Identification Handbook of Freshwater Zooplankton of the Mekong River and its Tributaries*, Mekong River Commission. Vientiane. 207pp.
63. Porchas-Cornejo, M. A., Martínez-Porchas, M., Martínez-Córdova, L. R., Ramos-Trujillo, L., and Barraza-Guardado, R., (2012). Consumption of natural and artificial foods by shrimp (*Litopenaeus vannamei*) reared in ponds with and without enhancement of natural productivity. *Isr. J. Aquacult.-Bamidgeh.*, IJA-64.709. 7 pp.
64. Pulle, J.S. and Khan, A.M. (2003). Phytoplanktonic study of Isapur dam water. *Ecology and Environmental Conservation*. 9:403-406.
65. Ramírez-Rochín, J., Frías-Espéricueta, M. G., Fierro-Sañudo, J. F., Alarcón-Silvas, S. G., Fregoso-López, M. G. and Páez-Osuna, F. (2017). Acute toxicity of nitrite on white shrimp *Litopenaeus vannamei* (Boone, 1931) juveniles in low-salinity water. *Aquaculture research*. 48(5): 2337-2343.
66. Reddy, M. H. and Mounika, K. (2018). Determination and comparative study of water quality parameters in shrimp culture ponds. *International Journal for Research in Applied Science and Engineering Technology*. 6(9):216-221.
67. Romano, N. and Zeng, C. (2007). Ontogenetic changes in tolerance to acute ammonia exposure and associated gill histological alterations during early juvenile development of the blue swimmer crab, *Portunus pelagicus*. *Aquaculture*. 266(1-4): 246-254.
68. Roy, L. A., Davis, D. A., Saoud, I. P., Boyd, C. A., Pine, H. J. and Boyd, C. E. (2010). Shrimp culture in inland low salinity waters. *Reviews in Aquaculture*. 2(4):191-208.
69. Saraswathy, R., Muralidhar, M., Ravichandran, P., Lalitha, N., Kanaga Sabapathy, V and Nagavel, A. (2013). Plankton Diversity in *Litopenaeus vannamei* Cultured Ponds. *International Journal of Bio-resource and Stress Management*. 4(2):114-118.
70. Schrader, K.K., Green, B.W. and Perschbacher P.W. (2011). Development of phytoplankton communities and common off flavors in a biofloc technology system used for the culture of channel catfish (*Ictalurus punctatus*). *Aquac Eng*. 45:118–126.
71. Serediak, N. and Huynh, M.L. (2011). *Algae Identification Field Guide and Agri-Food Canada*, Agri-Environment Services Branch. 40.
72. Simbeye, D. S. and Yang, S. F. (2014). Water quality monitoring and control for aquaculture based on wireless sensor networks. *Journal of Networks*. 9(4):840-849.
73. Tacon, A.G. (2020). Trends in global aquaculture and aquafeed production: 2000–2017. *Reviews in Fisheries Science and Aquaculture*. 28(1): 43-56.
74. Thirumala, S., Kiran, B.R., Puttalah, E., Kumara, V. and Babu, K.H. (2007). Zooplankton diversity and its relationship with physico-chemical parameters in Ayyanakere Lake of western Ghats, India. *Uttar Pradesh Journal of Zoology*. 203-207.





### Marimuthu and Puvaneswari

75. Venkateswarlu, V., Sesaiah, P.V., Arun, P. and Behra, P.C. (2019). A study on water quality parameters in shrimp *L. vannamei* semi-intensive grow out culture farms in coastal districts of Andhra Pradesh, India. International Journal of Fisheries and Aquatic Studies. 7(4): 394-399.
76. Vinatea, L., Muedas, W. and Arantes, R. (2011). The impact of oxygen consumption by the shrimp *Litopenaeus vannamei* according to body weight, temperature, salinity and stocking density on pond aeration: a simulation. Acta Scientiarum - Biological Sciences. 33(2):125-132.
77. Wyban, J., Walsh, W. A. and Godin, D. M. (1995). Temperature effects on growth, feeding rate and feed conversion of the Pacific white shrimp (*Penaeus vannamei*). Aquaculture. 138:267-279.

**Table 1. Seasonal variation in water quality parameters of Normal pond and Biofloc tank**

Sl.No	Sample description	Optimal range	Winter		Summer	
			Normal	Biofloc	Normal	Biofloc
1.	Temperature	26 – 32°C	27±0.7	28±0.1	29±0.8	30±0.8
2.	pH	7.0 – 8.3	7.8±0.06	7.9±0.07	7.8 ±0.05	8.0±0.08
3.	D.O (day)	> 4 (mgL <sup>-1</sup> )	6.3±0.15	6.9±0.14	6.5±0.10	7.0±0.10
	D.O (Night)	> 4 (mgL <sup>-1</sup> )	5.4±0.07	5.8±0.10	5.6±0.08	6.1±0.09
4.	Carbon dioxide	< 20(mgL <sup>-1</sup> )	16±0.34	17±0.98	13±0.89	16±0.69
5.	Salinity	0 – 35(‰)	02±0.0	02±0.0	02±0.0	02±0.0
6.	Alkalinity	90 – 180 (mgL <sup>-1</sup> )	171±0.47	172±0.53	162±0.48	168±0.60
7.	Ammonia	< 0.5 (mgL <sup>-1</sup> )	0±0.000	0±0.00	0±0.00	0±0.00
8.	Nitrate	< 5.00 (mgL <sup>-1</sup> )	0±0.00	0±0.01	0±0.00	0±0.00
9.	Nitrite	< 0.1 (mgL <sup>-1</sup> )	0±0.00	0±0.00	0±0.00	0±0.00
10.	Carbonate	0 – 25 (mgL <sup>-1</sup> )	12±0.75	15±0.50	10±0.63	13±0.83
11.	Bicarbonate	90 – 160 (mgL <sup>-1</sup> )	103±0.52	117±0.68	108±0.43	100±0.50
12.	Transparency	35 – 45 (cm)	42±0.2	38±0.9	36±0.8	38±0.9

(N=6) ; (Mean ± Standard Deviation)

**Table 2. Quantity of Plankton Identified in Normal pond and Biofloc tank during different seasons**

Plankton Identification	Winter		Summer	
	Normal	Biofloc	Normal	Biofloc
<b>Phytoplankton (Green Algae)</b>				
Euglena	91±1.94	85±1.37	95±2.42	89±1.36
Cosmarium	76±1.75	68±2.42	88±1.94	79±1.94
Pandorina	79±1.47	73±2.07	96±1.67	88±1.72
Actinastrum	81±1.63	72±2.33	85±1.51	85±2.42
Scenedesmus	85±1.75	79±1.21	94±2.71	87±1.94
Selenastrum	75±3.61	68±2.34	88±2.33	71±2.16
Chlamydomonas	82±1.45	78±1.87	86±1.38	80±1.90
Monoraphidium	81±2.46	77±2.07	83±1.94	78±1.76
<b>Diatoms</b>				
Encyonema	72±1.34	68±1.83	77±1.98	75±2.10
Melosira	65±2.34	62±1.63	70±1.42	67±1.18
Stephanodiscus	79±1.83	76±1.67	88±1.20	84±1.40
Cyclotella	63±2.64	59±2.18	69±1.89	70±1.47
<b>Micro Algae</b>				

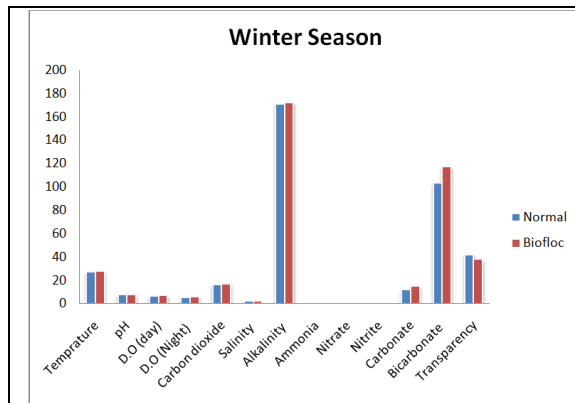




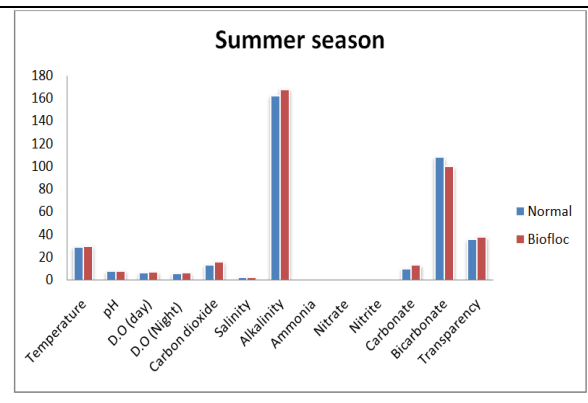
**Marimuthu and Puvaneswari**

Chlorella	77±1.76	69±2.09	71±1.67	66±1.76
Thalassiosira	74±2.00	69±2.06	65±2.09	59±1.86
Haematococcus	63±1.38	60±1.16	68±1.97	64±1.73
<b>Blue Green Algae</b>				
Spirulina	50±1.16	47±1.03	59±1.63	56±1.86
Oscillatoria	50±1.32	44±1.75	60±1.72	55±1.75
Anabaena	31±2.73	26±2.75	40±2.19	34±2.33
<b>Zooplankton</b>				
Brachionus	90±1.47	86±1.64	95±1.36	89±1.47
Chydrous	69±2.25	64±2.13	74±2.50	68±2.16
Daphnia	75±1.36	69±1.87	79±1.75	72±1.72
Cyclidium	62±2.25	57±1.50	67±1.67	65±1.26
Cyclopid	81±1.78	77±1.69	86±2.01	80±1.89

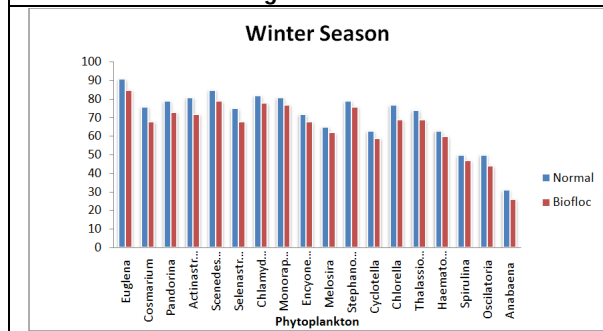
(N=6) ; (Mean ± Standard deviation)



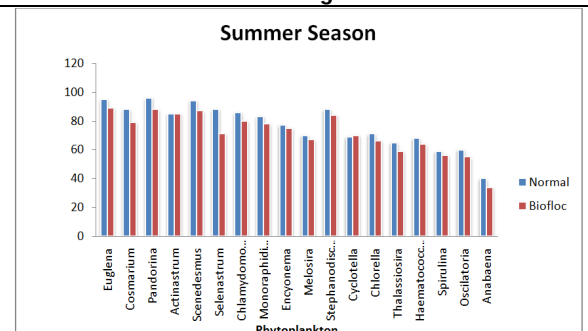
**Fig. 1. The water quality parameters in Normal pond and Biofloc tank during winter Season**



**Fig. 2. The water quality parameters in Normal pond and Biofloc tank during summer Season**



**Fig. 3. Comparison of phytoplankton quantity identified in two different culture systems during winter season**

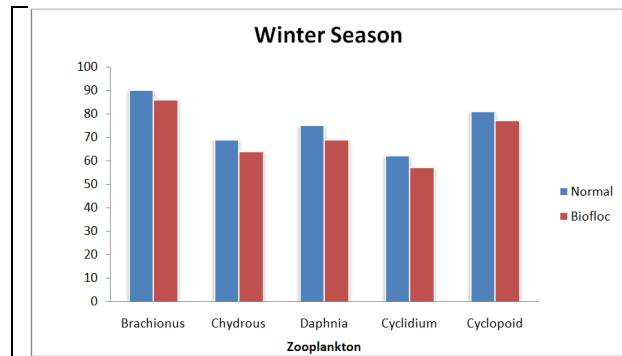


**Fig. 4. Comparison of phytoplankton quantity identified in two different culture systems during summer season**

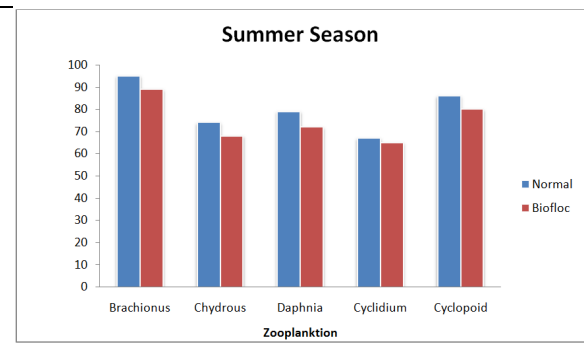




**Marimuthu and Puvaneswari**

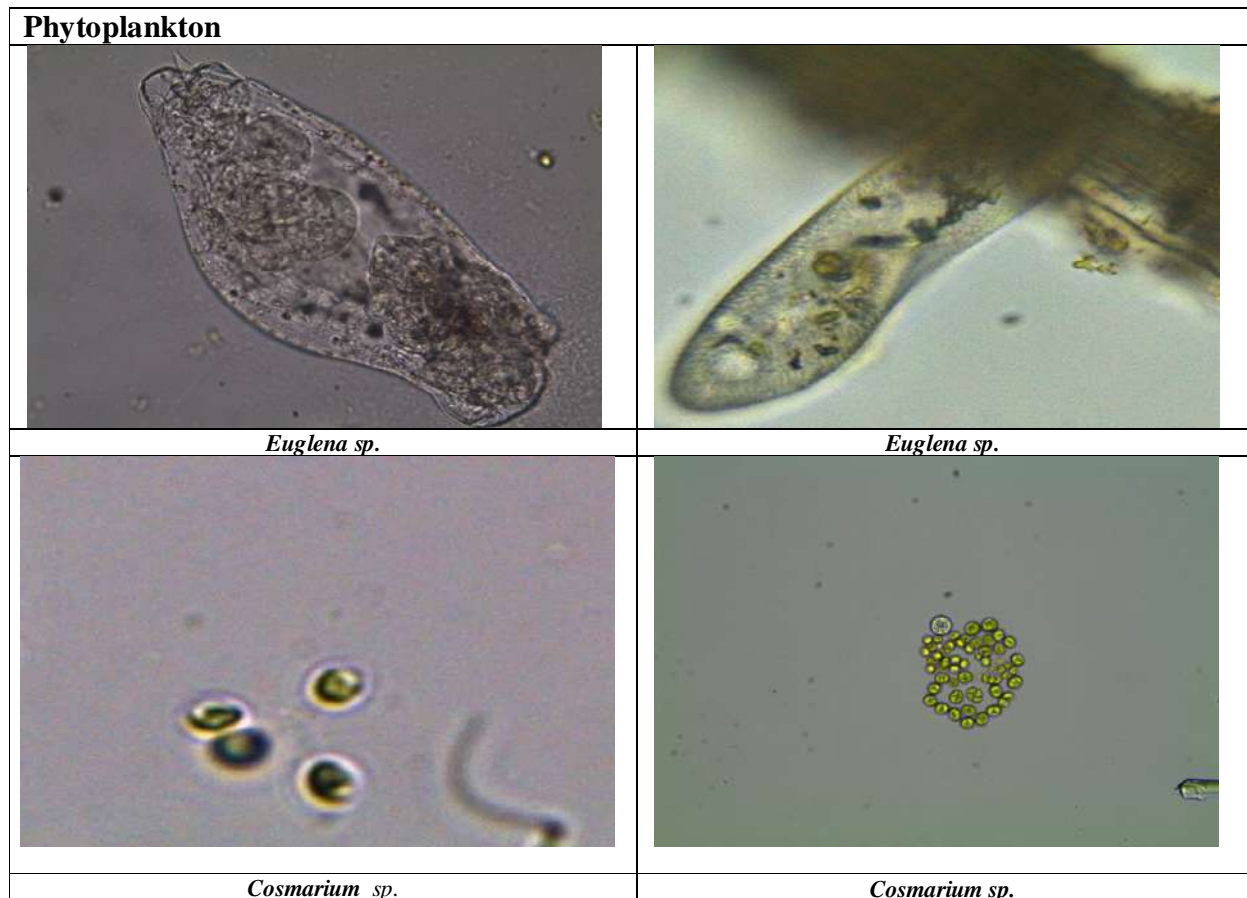


**Fig. 5. Comparison of zooplankton quantity identified in two different culture systems during winter season**





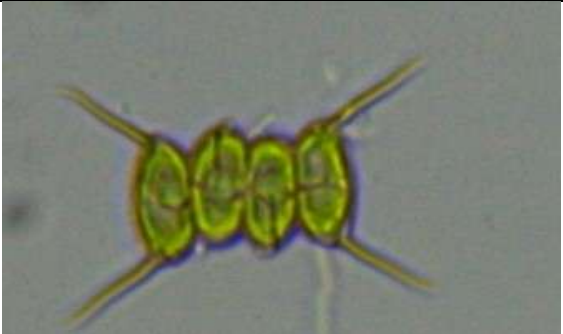



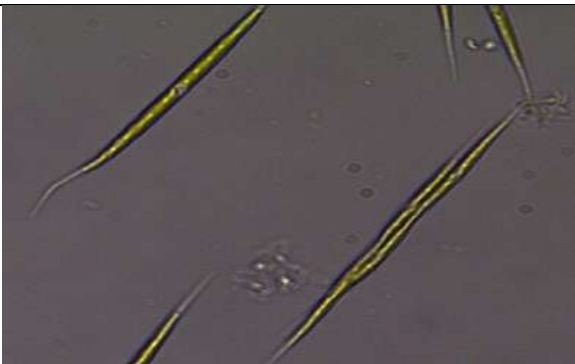
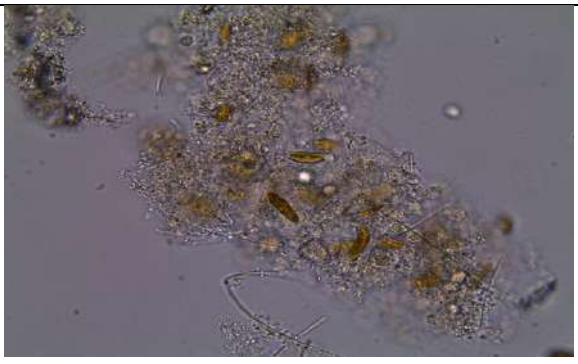
**Fig. 6. Comparison of Zooplankton quantity identified in two different culture systems during summer season**

**Plate 1. Plankton identified in normal pond and Biofloc tank during winter and summer seasons**






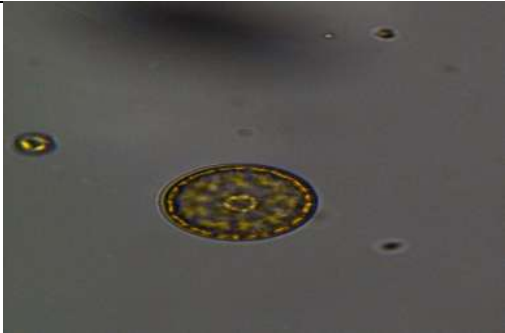

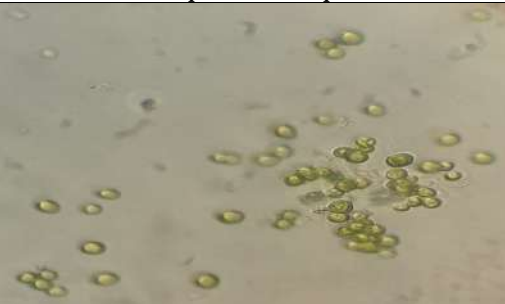

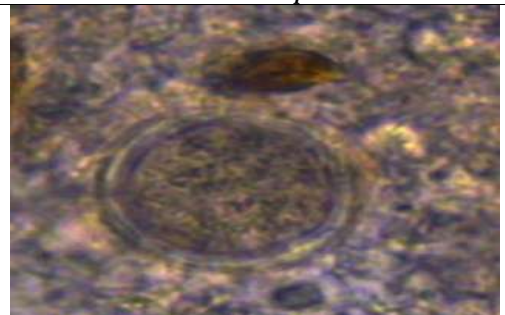


Marimuthu and Puvaneswari

	
<p><i>Pandorina sp.</i></p>	<p><i>Actinastrum sp.</i></p>
	
<p><i>Scenedesmus sp.</i></p>	<p><i>Scenedesmus sp.</i></p>
	
<p><i>Selenasstrum sp.</i></p>	<p><i>Chlamydomonas sp.</i></p>
	
<p><i>Monoraphidium sp.</i></p>	<p><i>Encyonema sp.</i></p>





Marimuthu and Puvaneswari

	
<i>Melosira sp.</i>	<i>Stephanodiscus sp.</i>
	
<i>Cyclotella sp.</i>	<i>Chlorella sp.</i>
	
<i>Thalassiosira sp.</i>	<i>Haematococcus sp.</i>
	
<i>Spirulina sp.</i>	<i>Oscillatoria sp.</i>





**Marimuthu and Puvaneswari**



*Anabeana sp.*

**Plate 2. Zooplankton**

<i>Brachionus sp.</i>	<i>Brachionus sp.</i>
<i>Daphnia sp.</i>	<i>Cyclidium sp.</i>
<i>Chydorus sp.</i>	<i>Cyclopoida sp.</i>





## A Retrospective Study on Drug Utilization and Prescribing Pattern in the Management of Copd in A Tertiary Care Hospital of Salem District using ATC and DDD Concept

Mohamed Yasir Arafath.A.A<sup>1\*</sup> and Peely L.R<sup>2</sup>

<sup>1</sup>Associate Professor, Department of Pharmacy Practice, Vinayaka Mission's College of Pharmacy, Salem, Tamil Nadu, India

<sup>2</sup>M.Pharm Student, Department of Pharmacy Practice, Vinayaka Mission's College of Pharmacy, Salem, Tamil Nadu, India

Received: 17 Dec 2021

Revised: 09 Jan 2022

Accepted: 21 Jan 2022

### \*Address for Correspondence

**Mohamed Yasir Arafath.A.A**

Associate Professor,

Department of Pharmacy Practice,

Vinayaka Mission's College of Pharmacy,

Salem, Tamil Nadu, India

Email: yasirpharma86@gmail.com



This is an Open Access Journal / article distributed under the terms of the **Creative Commons Attribution License** (CC BY-NC-ND 3.0) which permits unrestricted use, distribution, and reproduction in any medium, provided the original work is properly cited. All rights reserved.

### ABSTRACT

The goal of study is to identify the drug utilization and prescribing pattern in the management of COPD using the ATC and DDD concept. The study concept was explained the day to day functioning status of health care delivery system. A retrospective study was conducted on 200 cases, over a period of 10 months in tertiary care hospital of Salem. Out of 200 patients, 77% were male and 23% were female, which is largely due to cigarette smoking. As per the EDL- WHO 2021 four drugs were followed. Most prescribed injection from this study Deriphylline and Amoxicillin (22%) were commonly prescribed antibiotics. 80.5% patients were prescribed with combinational therapy. Corticosteroids were used in 37.82% prescription as monotherapy. From the study, it is concluded that the prescribing patterns were not in accordance with WHO guidelines. It is thus necessary to make physicians aware about the use of drugs, importance of prescribing drugs with generic names, safety of prescribing drugs from EDL and that the DDD methodology is useful technique to measure and compare drug consumption data nationally and internationally.

**Keywords:** Retrospective, COPD, EDL-WHO, ATC-DDD

### INTRODUCTION

Drug utilization review (DUR) is defined as an authorized, organized, study of prescribing, dispensing and use of various types of medication. DUR study involves a complete study of the prescriptions and the related drug data<sup>1</sup>





**Mohamed Yasir Arafath and Peely**

Drug Utilization is otherwise known as Drug Utilization Review and also the utilization evaluation and medication utilization evaluations are the same as drug utilization review. DUR important contributions include prescriber review, corrective actions and likewise evaluations as a quality assurance mechanism. DUR can optimize the inappropriate use of drugs which hike the adverse and mortality of the patients. Therefore, the DUR study becomes the important factor in assessment of the health program. The drug therapy after the patient has received the medication is known as retrospective DUR. The aim of retrospective review is to detect the pattern in prescribing, dispensing, or advertising and it also prevents the duplication of the medication. This review outcome may improve the aid of the prescriber's care to their patient [2]. Prescription pattern monitoring studies (PPMS) are drug utilization studies with the focus on prescribing, dispensing, and administering of drugs. The aim of PPMS is to ease the rational use of drugs in a population. Irrational use of medicines is a major problem worldwide. WHO estimates that more than half of all medicines are prescribed, dispensed or sold unsuitably, and that half of all patients fail to take them correctly. The overuse, underuse or misuse of medicines results in wastage of scarce resources and widespread health hazards. The rational use of medicines (RUM) is defined as "Patients receive medications appropriate to their clinical needs, in doses that meet their own individual requirements, for a sufficient period of time, and at the lowest cost to them and their community [3].

The term COPD (Chronic obstructive pulmonary disease) originate historically from the fusion of two disease organization that was previously considered separate: pulmonary emphysema and chronic (obstructive) bronchitis. COPD is a heterogeneous, common, preventable, and treatable disease that is characterized by persistent respiratory symptoms and airflow limitation that are due to alveolar abnormalities, usually caused by significant exposure to noxious particles or gases. The characteristic clinical features of COPD are respiratory symptoms such as cough or dyspnea in interconnection with a pharmacologically irreversible, or minimally reversible, airway obstruction that progresses over time. COPD is characterized by exacerbations, which tend to appear about once per year. Medical co morbidities are common among COPD patients and occur across the spectrum of disease severity. Multiple comorbidities often co-exist, and several clusters can be discriminated. COPD patients were reported to have a median of nine comorbidities. Cardiovascular disease (including hypertension, atherosclerotic coronary artery disease, congestive heart failure, atrial fibrillation, stroke, and peripheral vascular disease) is one of the most common co morbidities [5]. The world health organization (WHO) defines essential medicines as those satisfy the preference healthcare necessity of the population. Only some medicines can be designated as essential ones. The WHO introduced the concept of essential medicines in the year 1977. Essential medicines are planned to be always available within the circumstances of functioning health systems in adequate amounts, in the appropriate dosage forms, with encourage quality and adequate information and at a price the individual and the community can afford [6]. The ATC index is an anatomic-therapeutic-chemical (ATC) classification system which allots code letters and numbers to all drugs on an ATC basis. The defined daily dose (DDD) concept was developed to overthrow objections against traditional units of measurement of drug consumptions. DDD for a given drug is established based on the presumed average use per day of the drug used for its main indication in adult. It is expressed as DDD per thousand persons per day (DDD/1000/day) and provides a rough estimate of consumption [7].

**MATERIALS AND METHODS**

A retrospective study was conducted for the period of 10 months between February to November 2021 in the VMKVMC&H, Salem, Tamilnadu. A total of 200 cases were collected from medical record department, all the relevant and necessary data is collected from patient case sheets. The inclusion criteria, which includes patients who are diagnosed with chronic obstructive pulmonary disease in the age group of 21 to 70 years. The Pregnant and lactating women are not included in the study. The data collection form includes demographic details, past medical and medication history, social habits like smoking and alcohol consumption, Co-morbidity, commonly prescribing class of drugs, number of drugs per prescription, dosage form of prescribed drugs cases screened according to type of therapy (mono therapy/combinational therapy).



**Mohamed Yasir Arafath and Peely**

## RESULTS AND DISCUSSION

In the present study, the analysis showed that COPD occur more in men than in women, which was confirmed by demographic results and is largely due to cigarette smoking. The study showed that the majority of the patients suffering from COPD belong to the age group between 61-70 years (46.50%). As per the socioeconomic status, patients were divided in to five groups most of the patients were labourer (45.5%). Based on diagnosis, COPD patients with Co-morbid conditions were found to be 174 (87%), similarly the patients without Co- morbid condition were found to be 26(13%). The distribution of various Co-morbid conditions in our study was shown that among 174 patients, 64 patients was found to have Hypertension (26.4%), 55 patients were affected with Diabetes mellitus (22.72%) followed by 25 patients were affected with Acute renal failure (10.33%).

During the study the prescriptions were analyzed based on number of drugs per prescription, in which 92 prescriptions were with 4-6 drugs which is the highest percentage, and 24 prescriptions were with 10 and above drugs which is least percentage. Among 200 patients, based on month wise distribution the most affected patients found to be highest in the month of November 56(28%) and the least in the month of July 4(2%), and it was found that most of the patients 69(34.5%) were hospitalized for 3-4 days. The present study, most of the drugs were prescribed by brand name (61%) and only (39%) were prescribed by their generic name. Prescribing the drugs with their brand name increases the cost of therapy to the patients. Increasing generic prescribing would rationalize the use and reduce the cost of drug, and also reduces confusion relating to drug names, cost and stock items. Out of all COPD drugs, only four drugs were followed EDL-WHO 2021. Use of the drugs from the essential drug list should be promoted for the optimal use of limited resources, for maximum safety and to satisfy the health care needs of the majority of population.

Among the 200 prescriptions, injection route delivers more as compared to other dosage form. The commonly prescribed injection is Deriphylline [80 (26.57%)] and Budecort [Budesonide, 114(38%)] were most commonly prescribed Respules. The most prescribed Antibiotic is Amoxicillin [31(22%)]. Patients with COPD mostly require more than one drug to control the symptoms. In the present study, most patients were on multiple drug therapy. Corticosteroids 264(37.82%) class of drugs were used in maximum as monotherapy. In 2- drug therapy (Etofylline+ Theophylline) was used in majority as the approach of management. Among 200 collected prescriptions, were distributed based on ATC Code and DDD/100/ Patients/Day were calculated for COPD drugs with each category with WHO DDD Value.

## CONCLUSION

This study was undertaken in a tertiary care hospital which gives insight into the day to day functioning status of our health care delivery system and this study showed that valuable information can be obtained by using the DDD methodology on a retrospective basis. Because DDD calculations are independent of dosage form, the calculation of DDDs makes it possible to study national and international data respectively. From the above study it was concluded that, the prescribing patterns were not in accordance with WHO guidelines. It is thus necessary to make physicians aware about the use of drugs, importance of prescribing drugs with generic names, safety of prescribing drugs from EDL and that the DDD methodology is useful technique to measure and compare drug consumption data nationally and internationally.

## REFERENCES

1. Thadiboina M, Adithya S, Vadivel K. Drug Utilization review in post operative patients in obstetrics-gynaecology and surgical gastroenterology departments- a retrospective study. Int J Pharm Pharm Sci.2018 Oct 1;10:11



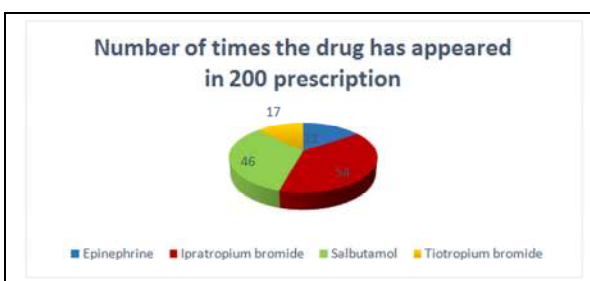


**Mohamed Yasir Arafath and Peely**

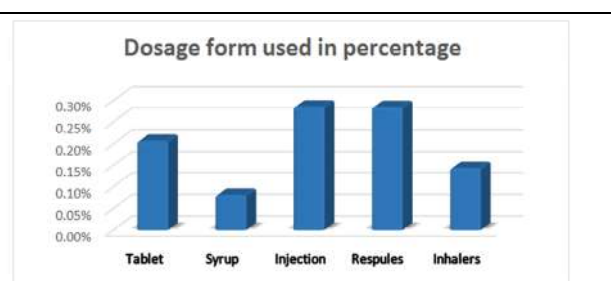
2. Jacob P, Balasubramanian A, Ramalingam K. A review on steps involved in drug utilization review. *Int J Res Pharm Sci.* 2020 Jul 24; 11:4095-8
3. Mohamed Yasir Arafath, Varghese M, Wilson M, Monika S. A retrospective study on drug utilization review and prescribing pattern in patients with respiratory diseases in a tertiary care hospital, Salem, India. *Int Res J Pharm.* 2019; 9:114-9
4. Burkhardt R, Pankow W. *The Diagnosis of Chronic Obstructive Pulmonary Disease.* 2014
5. Franssen FME, Rochester CL. Comorbidities in patients with COPD and pulmonary rehabilitation: Do they matter? *Eur Respir Rev.* 2014;23(131):131-41.
6. Ritesh Singh, Keshab Mukhopadhyay. Essential medicine list. *Muller Journal of Medical Science and Research.* 2014; 5(1):56-58
7. Shrishlya MV, Mahesh K, Nagarani MA, Sr Mary C, Andrade C, Venkataraman BV. Prescription audit study in an Indian hospital setting using the DDD (defined daily dose) concept. *Indian Journal of Pharmacology.* 1994; 26(1):23-8.

**Table No 1: ATC Code and DDD/100 Patients/Day**

S. No	Drug	ATC Code	WHO DDD	DDD/ 100 Patients/ Day
1	Tab. Azithromycin	J01FA10	0.3	40.3
2	Tab. Prednisolone	H02AB06	10	5.25
3	Tab. Doxofylline	R03DA11	8	12.2
4	Tab. Salbutamol	R03CC02	12	9.3
5	Tab. Theophylline	R03DA04	0.4	5.25
6	Tab. Roflumilast	R03DX07	0.5	6.8
7	Inj. Hydrocortisone	H02AB09	30	125.8
8	Inj. Terbutaline	R03CC03	15	0.2
9	Inj. Epinephrine	C01CA24	0.5	8.7
10	Inj. Augmentin	J01CR02	3	1.8
11	Inj. Methylprednisolone	H02AB04	20	25.7
12	Inj. Dexamethasone	H02AB02	1.5	0.9
13	Neb. Budesonide	R03BA02	1.5	25.1
14	Neb. Ipratropium Bromide	R03BB01	0.3	0.6
15	Neb. Salbutamol	R03AC02	10	9.02
16	Inh. Fluticasone	R03BA05	0.6	1.13
17	Inh. Budesonide	R03BA02	0.8	8.71
18	Inh. Tiotropium Bromide	R03BB04	10	41.9
19	Inh. Ipratropium Bromide	R03BB01	0.12	7.72
20	Inh. Salbutamol	R03AC02	0.8	0.7



**Figure No 1: Analysis of Prescription Based on Essential Drug List**

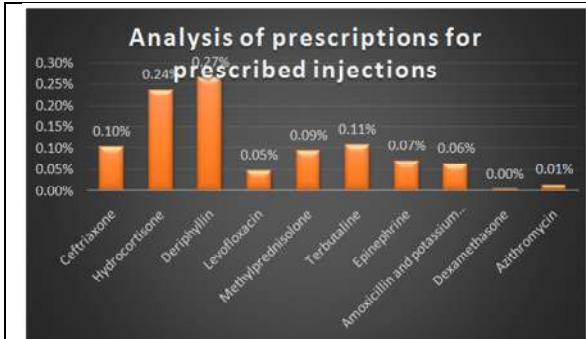


**Figure No 2: Analysis of Prescriptions Based on the Dosage form**

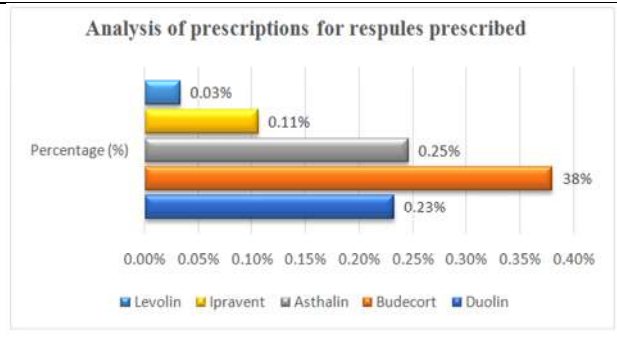




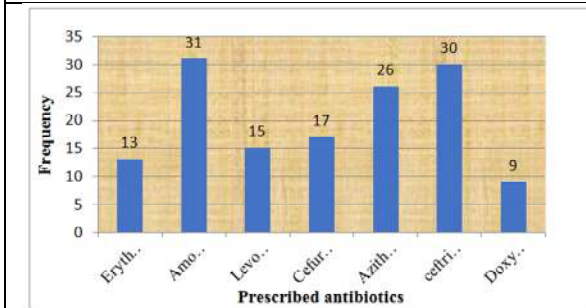
**Mohamed Yasir Arafath and Peely**



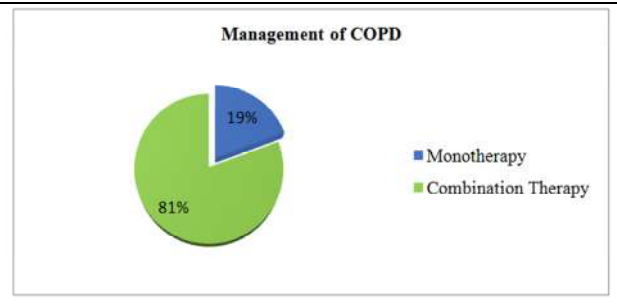
**Figure No 3: Analysis of Prescriptions for Injections Prescribed**



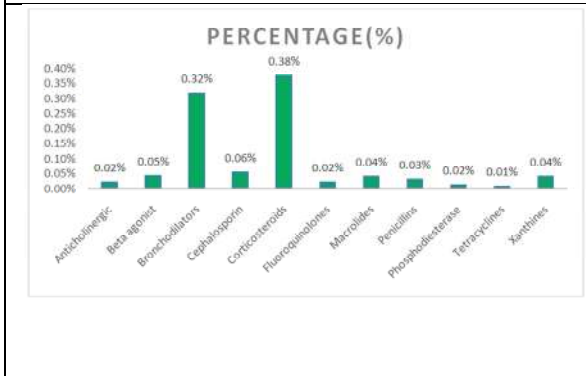
**Figure No 4: Analysis of Prescriptions for Respules Prescribed**



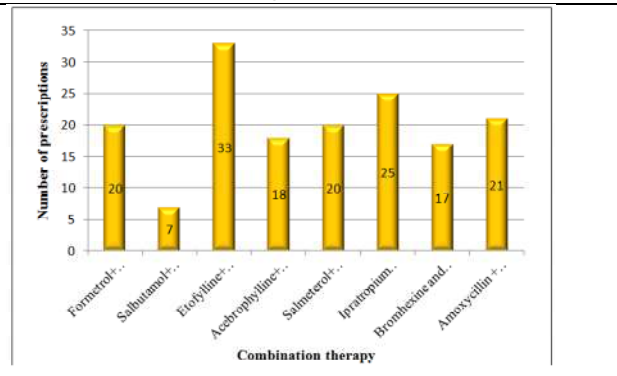
**Figure No 5: Analysis of Prescriptions for Antibiotics Prescribed**



**Figure No 6: Analysis of Prescriptions Based on the Approach of Management**



**Figure No 7: Analysis of Prescriptions Based on Monotherapy**



**Figure No 8: Analysis of prescription based on combinational therapy**





## Phytochemical Screening and Antioxidant Activity of *Melia dubia* Cav Leaves by using Various *In vitro* Models

T.Vinciya<sup>1\*</sup> and S.Rani<sup>2</sup>

<sup>1</sup>Research Scholar, Department of Pharmacy, Annamalai University, Annamalai Nagar, Chidambaram - 608002, Tamil Nadu, India.

<sup>2</sup>Associate Professor, Department of Pharmacy, Annamalai University, Annamalai Nagar, Chidambaram - 608002, Tamil Nadu, India.

Received: 13 Dec 2021

Revised: 30 Dec 2021

Accepted: 11 Jan 2022

### \*Address for Correspondence

**T.Vinciya**

Research Scholar,  
Department of Pharmacy,  
Annamalai University, Annamalai Nagar,  
Chidambaram - 608002, Tamil Nadu, India.  
Email: araschandra@gmail.com



This is an Open Access Journal / article distributed under the terms of the **Creative Commons Attribution License** (CC BY-NC-ND 3.0) which permits unrestricted use, distribution, and reproduction in any medium, provided the original work is properly cited. All rights reserved.

### ABSTRACT

The aim of this study was to investigate the antioxidant activity and phytochemical analysis of the leaves extracts of *Melia dubia* cav. The phytochemical screening carried on the leaves extracts of *Melia dubia* cav, revealed the presence of some active ingredients such as Alkaloids, Tannins, Saponins, Phenols, glycosides, steroids, terpenoids and flavonoids. Therefore current research is aimed to study the antioxidant potential and phytochemical screening of *Melia dubia* cav . The successive solvent extracts such as Petroleum Ether extract of *Melia dubia* (PEEMD), Chloroform extract of *Melia dubia* (CEMD), Ethyl Acetate extract of *Melia dubia* (EAEMD), Ethanolic extract of *Melia dubia* (EEMD) and Aqueous extract of *Melia dubia* (AEMD) are used for the study. The result of the present study showed that the ethanolic leaves extract of *Melia dubia* cav contains the greatest antioxidant activity than other extracts. This research work is useful to animal study on leaf extract of *melia dubia*, Isolation of active principles and detection of exact mechanism.

**Keywords:** Melia Dubia, Phytochemical screening, and Antioxidant activity

### INTRODUCTION

Medicines that are used today are not definitely the same as those that were used in ancient times or even in the recent past. India has a wealth of medicinal plants, most of which have been traditionally used in Ayurveda, Unani





### Vinciya and Rani

systems of medicine and by tribal healers for generations. In ancient Indian literature, it is mentioned that every plant on this earth is useful for human beings, animals and other plants. Consuming a greater amount of antioxidant rich foods might help to protect against diseases which is suggested by various dietary research findings. Antioxidants are substances that control or obstruct the oxidation of cellular oxidizable substrates. They employ their effect by scavenging reactive oxygen species (ROS), and blocking the generation of ROS. ROS are free radicals involved in many human diseases. Superoxide anion radical ( $O_2^-$ ), the hydroxyl radical ( $OH^\bullet$ ) and hydrogen peroxide ( $H_2O_2$ ) are the most common kind of ROS. In modern decades, focus on plant research has extended all over the globe. Gathered data exposed the immense potential of medicinal plants applied in various traditional systems, for their biological actions and antioxidant principles

*Melia dubia* originates from the Meliaceae family and is an indigenous species of tree to India, South East Asia and Australia, where it has been cultivated as a source of firewood. The tree can be cultivated in all types of soil and requires a low supply of water initially on a weekly basis. *Melia dubia* has the unique feature of growing 40 to 60 feet within 2 years from planting. *Melia dubia*, a dicotyledonous multipurpose tree belonging to the family Meliaceae. *Melia dubia* cav (meliaceae; Neem) is an indigenous plant possessing several medicinal properties. *Melia azedarach* linn (synonym: *Melia azedarach* linn, Indian lilac, Persian lilac). The plant is traditionally used for the treatment of leprosy, inflammations, Analgesics and cardiac disorders. Its fruits extracts possess ovicidal and larvicidal activity

#### Botanical Description

Deciduous trees, upto 25 m high, bark 6-8 mm thick, dark brown, rough, lenticellate, exfoliators rectangular, long and broad, attached by the distal end, exfoliated surface brown; outer part pink, inner fibrous; young shoots and inflorescence scurfy tomentose. Leaves 2-3 pinnate, (rarely 1-pinnate), imparipinnate, attenuate, estipulate, rachis 10-30 cm long, terete, slender, swollen at base, scurfy tomentose when young; pinnae 3-7 pairs, 10-20 cm long; leaflets 2-11 on each pinnae, opposite, estipellate; petiole 3-10 mm long, slender; lamina 4.5-9 x 2-4 cm, ovate-lanceolate, base oblique, acute, obtuse, round or attenuate, apex acuminate, margin crenate, glabrous at maturity, coriaceous; lateral nerves 6-10 pairs, pinnate, slender, prominent; intercostale reticulate, prominent. Flowers bisexual, 5-6 mm long, greenish-white, in axillary panicles; calyx lobes 5, 2 mm long, ovate, pubescent; petals 5, 7-10 x 1-3 mm, obovate, thick, simple, pubescent within; staminal tube 7 mm, white, scabrid, ribbed, apically dilated, 10-dentate, tooth 2-fid, mouth woolly; disc annular; anthers exerted; ovary superior, oblong 1 mm, 5-celled; ovules 2 per cell; style to 4.5 mm, terete; stigma capitate.

The antioxidant potential of plant extracts cannot be assessed by using a single method, due to the complex constitution of phytochemicals as well as oxidative processes. Hence the present study was designed to estimate the antioxidant activity of Petroleum Ether extract of *Melia dubia* (PEEMD), Chloroform extract of *Melia dubia* (CEMD), Ethyl Acetate extract of *Melia dubia* (EAEMD), Ethanolic extract of *Melia dubia* (EEMD) and Aqueous extract of *Melia dubia* (AEMD) through a number of in vitro models like 2,2-diphenyl-1-picrylhydrazyl (DPPH), Hydrogen peroxide scavenging assay, Nitric oxide scavenging assay. Therefore current research is aimed to study the antioxidant potential and phytochemical screening of *Melia dubia* cav. The successive solvent extracts such as Petroleum Ether extract of *Melia dubia* (PEEMD), Chloroform extract of *Melia dubia* (CEMD), Ethyl Acetate extract of *Melia dubia* (EAEMD), Ethanolic extract of *Melia dubia* (EEMD) and Aqueous extract of *Melia dubia* (AEMD) are used for the study.

## MATERIALS AND METHODS

#### Plant collection and authentication

The fresh leaves of the plant *Melia dubia* are collected from Nagercoil, Kanyakumari District, Tamil Nadu, India. month of March 2021 and authenticated by Dr. N. Srinivasan, Department of Pharmacy, Annamalai University, Annamalai Nagar, Chidambaram-608002, Tamilnadu, India.

Voucher specimen No: PCOL/ 2021/004



**Vinciya and Rani****Preparation of plant material**

The collected leaves were cleaned, washed with distilled water, dried under sun shade in a dark room, and powdered by using a mechanical mixer. After size reduction leaves were sieved under sieve No. 40 and sieve No. 60, stored in an airtight container at room temperature .

**Extraction of the plant material**

200 g of finely powdered leaf powder was extracted with soxhlet using different solvents (nonpolar to polar solvents) successively with Petroleum ether, Chloroform, Ethyl acetate and Ethanol. After extraction the extracts were separately concentrated by distillation and dried at room temperature until they got to viscous solid mass. The obtained crude extracts were weighed and stored at 40 °C for the further analysis.

**Aqueous Extract**

The finely powdered leaf powder was extracted by cold maceration using water for 15 days. The extract was concentrated by surface evaporation followed by vacuum drying. Dry powder was weighed and stored in air-tight containers for further studies.

**Qualitative Phytochemical Screening**

The prepared extracts were subjected to preliminary phytochemical screening for the exposure of various plant constituents by the following standard procedure as detailed below

**Tests for alkaloids**

A small portion of the solvent free extract was stirred with a few drops of dilute hydrochloric acid and filtered. The filtrate was tested carefully with various alkaloid reagents such as:

**Mayer's reagent**

The filtrate was treated with Mayer's reagent (potassium mercur solution). The appearance of cream color indicated the presence of alkaloids.

**Dragendorff's reagent**

A little amount of the filtrate was treated with Dragendorff's reagent (potassium bismuth iodide solution). The appearance of reddish brown precipitate indicated the presence of alkaloids.

**Hager's reagents**

The test sample was treated with Hager's reagent (picric acid). The appearance of yellow precipitate indicated the presence of alkaloids.

**Wagner's reagent**

A little amount of the extract was treated with Wagner's reagent (iodine and potassium iodide solution). The appearance of reddish brown precipitate indicated the presence of alkaloids.

**Test for carbohydrates**

Dissolve a small quantity of the extract in 4 mL of distilled water and filter. The filtrate was subjected to Molisch's test for the presence of carbohydrate.

**Molisch's Test**

To 2 mL of extract, 1 mL of  $\alpha$ -naphthol solution was added and conc. sulphuric acid was added through the sides of the test tube. Formation of the violet color ring at the junction of two liquids indicated the presence of carbohydrates.





**Vinciya and Rani**

**Tests for glycosides**

Another small portion of the extract was hydrolyzed with diluted hydrochloric acid for a few minutes in a heated water bath and the hydrolysate was subjected to Legal's and Borntrager's tests to detect the presence of different glycosides.

**Legal's test**

To the hydrolysate, 1 mL of pyridine and few drops of sodium nitroprusside solution were added and then it was made alkaline with sodium hydroxide solution. The appearance of pink to red color shows the presence of cardenolide glycosides.

**Borntrager's test**

To the hydrolysate, 1 mL of chloroform was added and shaken well. The chloroform layer was separated and to this equal amount of dilute ammonia solution was added. The appearance of a pink color in the ammonical layer indicated the presence of anthraquinone glycosides.

**Keller kiliani test**

When a pinch of the extract was dissolved in glacial acetic acid, a few drops of ferric chloride solution was added, followed by the addition of concentrated sulphuric acid, formation of red ring at the junction of two liquids indicated the presence of glycosides.

**Test for phytosterol**

**Libermann- Burchard's Test**

A small amount of the extract was dissolved in a few drops of glacial acetic acid. 3 mL of acetic anhydride was added, followed by adding a few drops of concentrated sulfuric acid. The appearance of bluish green color shows the presence of phytosterol.

**Salkowski Test**

Small quantity of the extract was dissolved in chloroform and the resulting solution was then shaken with a few drops of concentrated sulfuric acid. The appearance of bluish green color shows the presence of phytosterol.

**Tests for fixed oils and fats**

**Saponification test**

A few drops of 0.5 N alcoholic potassium hydroxide solution was added to a small quantity of extract along with a drop of phenolphthalein. The mixture was heated in a water bath for 1-2 h. Formation of soap or partial neutralization of alkali indicated the presence of fixed oils and fats.

**Spot test**

A small quantity of the extract was pressed between two filter papers. Oil stains on the paper indicated the presence of fixed oil.

**Test for saponins**

**Foam test**

1 g of the extract was shaken vigorously with 20 mL distilled water in a graduated cylinder for 15 min. a 1 cm layer of foam indicated the presence of saponins.

**Tests for tannins and phenolic compounds**

A small quantity of the extract was dissolved in water, warmed and filtered. The resulting filtrate was used for the following tests







**Vinciya and Rani**

**Ferric chloride test**

A small amount of the filtrate was treated with neutral ferric chloride solution. The appearance of violet color indicated the presence of phenols.

**Gelatin test**

A small amount of the filtrate was treated with 1% w/v solution of gelatin in water containing 10 % sodium chloride. The appearance of cream precipitate indicated the presence of phenolic compounds.

**Lead acetate test**

A small amount of the filtrate was treated with 10% lead acetate solution. The appearance of white precipitate indicated the presence of phenolic compounds.

**Tests for proteins and amino acids**

A small quantity of the extract was shaken with few mL of water and the resulting mixture was subjected to the following tests:

**Millon's test**

When the test sample was treated with Millon's reagent (Mercuric nitrate solution), formation of white precipitate indicated the presence of proteins.

**Ninhydrin test**

When the test sample was treated with 0.1% w/v solution of ninhydrin in n-butanol, the appearance of the violet or purple color indicated the presence of amino acid.

**Biuret test**

When the test sample was treated with equal volume of 5% sodium hydroxide solution and 1% copper sulphate reagent, appearance of the pink to purple color indicated the presence of proteins and free amino acids.

**Test for flavonoids**

A small quantity of the extract was shaken with a few mL of water and the resulting mixture was subjected to the following tests

**Shinoda's test**

A small quantity of the test sample was dissolved in 5 mL of alcohol (95%) and treated with few drops of concentrated hydrochloric acid and 0.5 g of magnesium turnings. Development of a pink color within a minute indicated the presence of flavonoids.

**Fluorescence test**

A few mg of the extract was dissolved in alcohol and a drop of the resulting solution was placed on Whatman filter paper and observed under UV light. The appearance of fluorescence indicated the presence of flavonoids.

**Test for lignin**

A small quantity of the extract was treated with few drops of phloroglucinol and hydrochloric acid. The appearance of pink or red color indicated the presence of lignin.

**Tests for detection of triterpenes**

**Salkowski's test**

A small quantity of the extract was taken in a dry test tube, added a few tin granules and 1 mL of thionyl chloride and shaken well. The appearance of a pink color indicated the presence of triterpenes.





### Vinciya and Rani

#### Libermann-Burchard's Test

To the solution of extract, 1 mL of acetic anhydride and acetic acid were added, followed by a few drops of concentrated sulfuric acid. A ray of colors from violet changing through purple to brown or blue indicated the presence of triterpenes

#### In vitro antioxidant studies

##### DPPH radical scavenging assay

Free radical scavenging ability of the extracts was tested by DPPH radical scavenging assay. The hydrogen atom donating ability of the plant extractives was determined by the decolorization of methanol solution of 2,2-diphenyl-1-picrylhydrazyl (DPPH). DPPH produces violet/purple color in methanol solution and fades to shades of yellow color in the presence of antioxidants. About 1ml of 0.135 mM DPPH in methanol was mixed with 1ml of different extract (0.02–0.1mg concentration in respective solvents). The mixture was incubated for a period of 30 min in the dark at room temperature. After the incubation period absorbance was measured at 517 nm in the spectrophotometer. Ascorbic acid was used as standard

The radical scavenging activity was calculated by,

$$\text{DPPH radical scavenging activity (\%)} = \frac{(\text{Abs control} - \text{Abs sample})}{(\text{Abs control})} \times 100$$

Where, Abs (control): Absorbance of the control and Abs (sample): Absorbance of the extracts/standard.

##### Determination of Nitric Oxide Scavenging Assay

The activity was measured according to the modified method of Sreejayan and Rao, To 4ml of the extract having different concentrations, 1 ml of sodium nitroprusside (SNP) solution (5mM) was added and incubated for 2hr at 27°C. An aliquot (2ml) of the incubation solution was removed and diluted with 1.2ml of Griess reagent (1% Sulfanilamide in 5% H<sub>3</sub>PO<sub>4</sub> and 0.1% naphthylethylene diamine dihydrochloride). The absorbance of the chromophore was read at 550 nm and compared with standard, Ascorbic Acid.

$$\text{Nitric oxide scavenging activity (\%)} = \frac{(\text{Abs control} - \text{Abs sample})}{(\text{Abs control})} \times 100$$

Where, Abs (control): Absorbance of the control and Abs (sample): Absorbance of the extracts/standard.

##### Hydrogen peroxide scavenging assay

The ability of the extract to scavenge hydrogen peroxide (H<sub>2</sub>O<sub>2</sub>) was determined according to the method of Ruch et al. Aliquot of 0.1 mL of extracts (25–400 µg/mL) was transferred into the eppendorf tubes and their volume was made up to 0.4 mL with 50 mM phosphate buffer (pH 7.4) followed by the addition of 0.6 mL of H<sub>2</sub>O<sub>2</sub> solution (2 mM). The reaction mixture was vortexed and after 10 min of reaction time, its absorbance was measured at 230 nm. Ascorbic acid was used as the positive control. The ability of the extracts to scavenge the H<sub>2</sub>O<sub>2</sub> was calculated using the following equation:

$$\text{H}_2\text{O}_2 \text{ scavenging activity percentage (\%)} = \frac{(\text{Abs control} - \text{Abs sample})}{(\text{Abs control})} \times 100$$

Where, Abs (control): Absorbance of the control and Abs (sample): Absorbance of the extracts/standard.





## Vinciya and Rani

## RESULTS

Table 1. Results of preliminary Phytochemical screening of *Melia dubia*

S No	Constituents	Observation				
		PEEMD	CEMD	EAEMD	EEMD	AEMD
1	Alkaloids	-	+	-	+	-
2	Carbohydrates	+	+	+	+	+
3	Proteins & amino acids	-	+	+	+	+
4	Steroids	+	+	+	+	-
5	Phenols	-	+	+	+	-
6	Tannins	-	+	+	+	-
7	Flavonoids	-	-	+	+	+
8	Glycosides	-	+	-	-	-
9	Saponins	-	-	-	+	+
10	Fixed oil and fats	+	+	-	-	-
11	lignin	-	-	-	-	+
12	Terpenoids	-	-	+	+	+

(-) indicates the absence of compound

(+) indicates the presence of compound

Table 2. DPPH Free Radical Scavenging Assay

S. No	Concentration µg/ml	% of Inhibition					
		Ascorbic Acid	PEEMD	CEMD	EAEMD	EEMD	AEMD
1	20	58.36	40.27	41.77	16.3	26.93	27.9
2	40	74.06	53.92	49.67	33.68	35.69	38.13
3	60	78.4	57.33	59.67	56.59	55.89	40
4	80	81.56	74.06	61.12	68.40	73.06	54.41
5	100	89.07	75.42	67.74	77.43	78.11	66.97

IC 50 Value of different extracts and standard:

Table 3. DPPH Free Radical Scavenging Assay

Plant extract/ Standard	IC 50 Value (µg/ml)
Ascorbic Acid	31.70
PEEMD	56.44
CEMD	55.74
EAEMD	59.80
EEMD	49.75
AEMD	70.35





### Vinciya and Rani

**Table 4. Determination of Nitric Oxide Scavenging Assay**

S. No	Concentration $\mu\text{g/ml}$	% of Inhibition					
		Ascorbic Acid	PEEMD	CEMD	EAEMD	EEMD	AEMD
1	20	61.16	22.95	23.37	18.06	16.72	17.59
2	40	73.88	40.44	29.50	40.13	45.01	38.91
3	60	79.03	41.57	49.04	53.51	59.16	46.60
4	80	82.81	49.11	62.06	69.56	71.06	47.37
5	100	90.03	56.50	72.79	72.91	76.20	51.43

**IC 50 Value of different extracts and standard**

**Table 5. Determination of Nitric Oxide Scavenging Assay**

Plant extract/ Standard	IC 50 Value ( $\mu\text{g/ml}$ )
Ascorbic Acid	30.51
PEEMD	78.81
CEMD	64.81
EAEMD	60.04
EEMD	56.65
AEMD	82.30

**Table 6. Hydrogen Peroxide Radical Scavenging Assay**

S. no	Concentration $\mu\text{g/ml}$	% of Inhibition					
		Ascorbic Acid	PEEMD	CEMD	EAEMD	EEMD	AEMD
1	20	57.19	23.37	29.15	41.07	47.70	32.27
2	40	72.28	28.35	45.55	52.52	49.01	40
3	60	75.08	45.97	51.85	58.24	57.54	43.18
4	80	81.05	65.90	66.29	62.96	62.13	49.54
5	100	92.28	72.79	73.76	76.09	88.36	63.18

**Table 7. IC 50 Value of different extracts and standard**

**Hydrogen Peroxide Radical Scavenging Assay**

Plant extract/ Standard	IC 50 Value ( $\mu\text{g/ml}$ )
Ascorbic Acid	33.04
PEEMD	64.57
CEMD	58.01
EAEMD	52.39
EEMD	48.87
AEMD	72.60





Vinciya and Rani

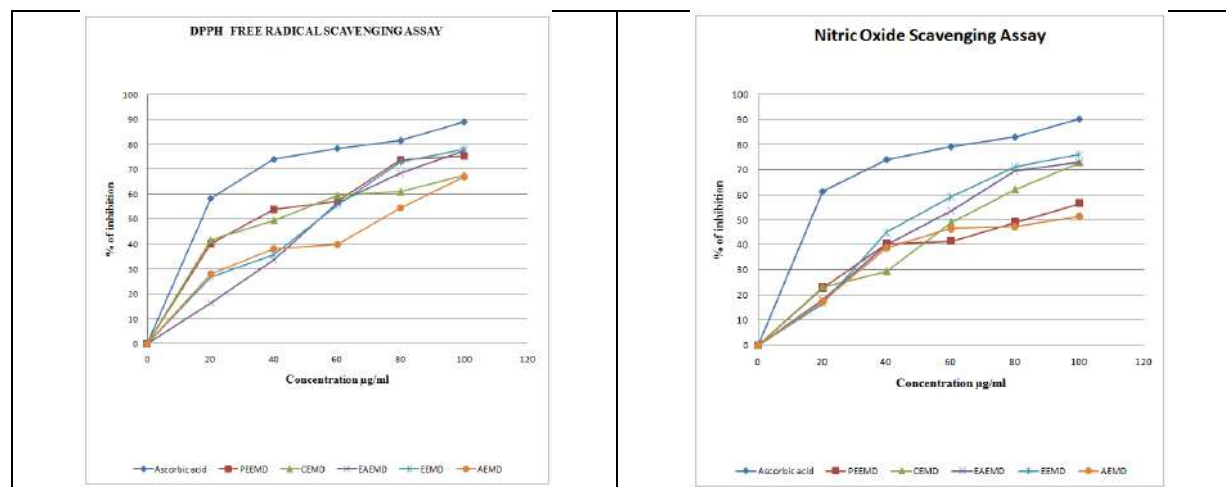


Fig.1.DPPH Free Radical Scavenging Assay

Fig.2.Nitric Oxide Scavenging Assay

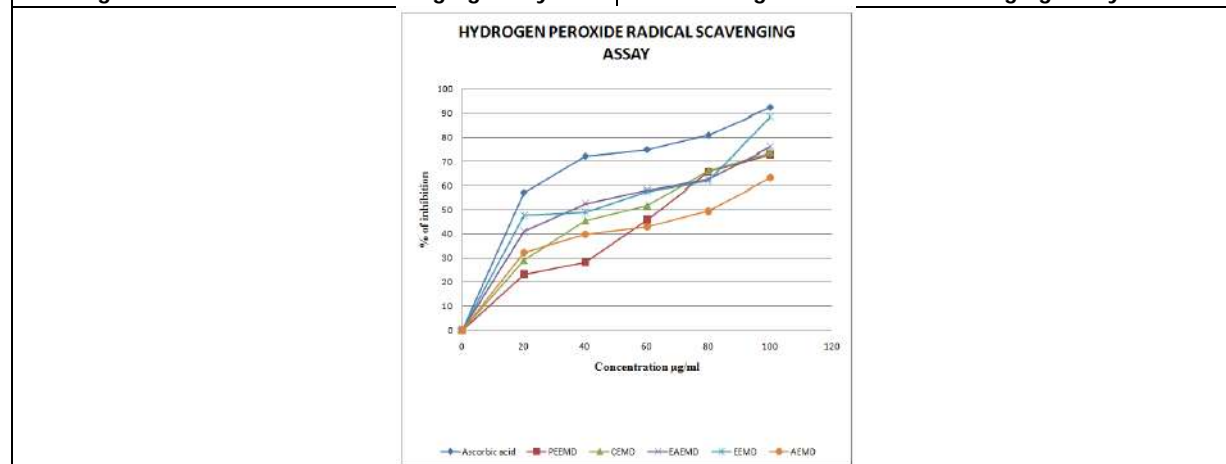


Fig.3.Hydrogen Peroxide Radical Scavenging Assay

DISCUSSION

Screening for its phytochemical constituents

The various extracts of *Melia Dubia Cav* were subjected to screening for its phytochemical constituents. The petroleum ether extract of *Melia dubia cav* showed the presence of carbohydrates, phytosterol, fixed oils and fats. Chloroform extract exhibited the presence of alkaloids, carbohydrates, glycosides, phytosterol, fixed oils, tannins and proteins. Ethyl acetate extract showed the presence of carbohydrates, phytosterol, proteins, tannins, flavonoids and triterpenes. Ethanolic extract exhibited the presence of alkaloids, carbohydrates, phytosterols, saponins, tannins, proteins, flavonoids and triterpenes. Aqueous extract showed the presence of carbohydrates, saponins, proteins, flavonoids, lignin and triterpenes.

In vitro antioxidant studies on the extracts

The antioxidant activity of Petroleum Ether extract of *Melia dubia* (PEEMD), Chloroform extract of *Melia dubia* (CEMD), Ethyl Acetate extract of *Melia dubia* (EAEMD), Ethanolic extract of *Melia dubia* (EEMD) and Aqueous extract of *Melia dubia* (AEMD) was assessed by three methods namely DPPH free radical scavenging assay, Nitric Oxide



**Vinciya and Rani**

scavenging assay, Hydrogen Peroxide radical scavenging assay. A lower value IC<sub>50</sub> observed for Ethanolic extract of *Melia dubia* (EEMD) (49.75µg/ml) in DPPH free radical scavenging assay compared to that of the other extracts. It indicates the antioxidant potential possessed by the Ethanolic extract is greater than that of the other extracts. However the antioxidant efficacy of the Ethanolic extract is lower than that of the standard Ascorbic Acid. A lower value IC<sub>50</sub> observed for Ethanolic extract of *Melia dubia* (EEMD) (56.65µg/ml) in Nitric Oxide scavenging assay compared to that of the other extracts. It indicates the antioxidant potential possessed by the Ethanolic extract is greater than that of the other extracts. However the antioxidant efficacy of the Ethanolic extract is lower than that of the standard Ascorbic Acid. A lower value IC<sub>50</sub> observed for Ethanolic extract of *Melia dubia* (EEMD) (48.87 µg/ml) in Hydrogen Peroxide radical scavenging assay compared to that of the other extracts. It indicates the antioxidant potential possessed by the Ethanolic extract is greater than that of the other extracts. However the antioxidant efficacy of the Ethanolic extract is lower than that of the standard Ascorbic Acid. The scavenging activity was increased as the extract concentration was increased. All the extracts showed good antioxidant activity but the Ethanolic extract of *Melia dubia* (EEMD) has more antioxidant activity.

**CONCLUSION**

From the results of this research it was concluded that leaf extract of *Melia dubia* for preliminary phytochemical screening showed the presence of almost all compounds. Ethyl acetate and ethanolic extract exhibited the presence of many important secondary metabolites like proteins, amino acids, flavonoids, tannins and phenolics and phytosterols. The free radical scavenging activity is one of the mechanisms of a plant to exhibit antioxidant activity. The polarity of compounds also plays a key role in their bioactivity. This research work is useful for further experimentation.

**REFERENCES**

1. Halliwell B. How to characterize an antioxidant: an update. *Biochem Soc Symp* 1995; 61: 73-101.
2. Squadriato GL, Pelor WA. Oxidative chemistry of nitric oxide: The roles of superoxide, peroxynitrite, and carbon dioxide. *Biol Med* 1998; 25: 392-403.
3. Donald RB, Cristobal M. Antioxidant Activities of Flavonoids. PhD thesis submitted to Department of Environmental and Molecular Toxicology, Oregon State University; 1987.
4. Han, J., Lin, W. H., Xu, R. S., Wang, W. L., and Zhao, S. H., Studies on the chemical constituents of *Melia azedarach* L. *Acta Pharm. Sin.* (in Chinese), 26, 426-429 (1991). PMID: 1789108.
5. P. C. Sharma, M.B. Yelne, T. J. Dennis, Database on Medicinal plants used in Ayurveda, (Documentation and Publication Division, Central Council for Research in Ayurveda and Siddha, New Delhi, 2001) pp. 389-406.
6. C.P. Khare, Encyclopedia of Indian Medicinal Plants, (Springer, Germany) pp.305- 306.
7. P. Suhag, Merra and S.B. Kalidhar. Phytochemical investigation of *Melia azedarach* leaves. *J. Med. Aromatic Plant Sci.* 25(2): 397-399 (2003).
8. Alagar RM, Sahithi G, Vasanthi R, David B, Rao KNV, Selvakumar D. Study of phytochemical and antioxidant activity of *Cucumis melo* var. *agrestis* fruit. *Journal of Pharmacognosy and Phytochemistry.* 2015; 4(2):303-306.
9. Gopala Satheesh Kumar K, Ariharasiva Kumar G, Sengottuvel T et al. Confirmation of Best Method for Detection of Alpha Amylase Activity of *Cucumis Melo* Var *Agrestis* (Wild Musk Melon). *J Adv Res Bio Chem Pharma* 2019; 2(1): 1-3.
10. Gopala Satheesh Kumar K, Parthiban S, Manimaran T, Boopathi T. Phytochemical Screening on Various Extracts (Benzene, Ethanolic and Aqueous) of Stem Parts of *Zanthoxylum Rhetsa* (Roxb.) Dc. *ijupbs.* 2017; 6(2):79-91.
11. Karthishwa K, Mirunalini S, Dhamodharan G, Krishnaveni M, Arulmozhi V. Phytochemical Investigation of Methanolic Extract of the Leaves of *Pergulariadaemia*. *Journal of Biological Sciences.* 2010; 10(3):242-246.
12. Trease GE, Evans WC. Textbook of Pharmacognosy. 12th edn. Balliere Tindall and Company Publisher, London.1983 pp. 343- 383.





**Vinciya and Rani**

13. Sharma A, Joshi N, Kumar R, Agrawal P, Prasad S. High performance liquid chromatographic analysis of phenolic compounds and their antioxidant properties from different cultivars of *Cyamopsis Tetragonoloba* (L.) Taub. *Microchemical Journal*. 2017; 133: 622-628.
14. Andriyani R, Budiati T, Pudjiraharti S. Effect of Extraction Method on Total Flavonoid, Total Phenolic Content, Antioxidant and Antibacterial Activity of *Zingiberis Officinale* Rhizome. *Procedia Chemistry*. 2015; 16:149-154.
15. Alves D, Maia de Moraes S, Tomiotto-Pellissier F, Miranda-Sapla M, Vasconcelos F, Silva I et al., Flavonoid Composition and Biological Activities of Ethanol Extracts of *Caryocarcoriaceum Wittm.*, a Native Plant from Caatinga Biome. *Evid Based Complement Alternat Med*. 2017; 2017:1-7.
16. Chekroun E, Benariba N, Adida H, Bechiri A, Azzi R, Djaziri R. Antioxidant activity and phytochemical screening of two Cucurbitaceae: *Citrullus Colocynthis* fruits and *Bryoniadioica* roots. *Asian Pacific Journal of Tropical Disease*. 2015; 5(8):632-637.
17. Sharma N, Suric J, Chandana BK, Singha B, Sattib N, Prabhakar A, Gupta BD, Mowkshikhullara, Ahmeda Z, Protective effect of a standardized fraction from *Vitex negundo* Linn. against acetaminophen and galactosamine induced Hepatotoxicity in rodents, *Biochemistry & Analytical Biochemistry*, 5(2), 2016, 1-9. DOI: 10.4172/2161-1009.1000267.
18. Ullah Z, Ullah R, Ali Shah AUH, Ahmed I, Haider S, Phytochemical and Biological Evaluation of *Vitex negundo* Linn: A review, 3(8), 2012, 2421-2431. DOI: 10.13040/IJPSR.0975-8232.3(8).2421-31.
19. Katsube T, Tabata H, Ohta Y, Yamasaki Y, Anuurad E, Shiwaku K, YamaneY. Screening for antioxidant activity in edible plant products: Comparison of low density lipoprotein oxidation assay. *Journal of Agriculture and Food Chemistry* 2004;52(8):2391-6.
20. Cai Y, Luo Q, Sun M, Corke H Antioxidant activity and phenolic compounds of 112 traditional Chinese medicinal plants associated with anticancer. *Life science* 2004;74:2157-84.

